

Nottingham Core HMA and Nottingham Outer HMA Employment Land Needs Study

Report

Ashfield District Council, Broxtowe Borough Council,
Gedling Borough Council, Erewash Borough Council,
Nottingham City Council, Mansfield Borough Council,
Newark & Sherwood District Council and Rushcliffe
Borough Council

May 2021

LICHFIELDS

LICHFIELDS

Lichfields is the pre-eminent planning and development consultancy in the UK

We've been helping create great places
for over 50 years.

[lichfields.uk](https://www.lichfields.uk)

© 2021 Nathaniel Lichfield & Partners Limited (trading as "Lichfields"), All Rights Reserved, is registered in England, no. 2778116.
Registered office at The Minster Building, 21 Mincing Lane, London EC3R 7AG.
Formatted for double sided printing.
Plans based upon Ordnance Survey mapping with the permission of Her Majesty's Stationery Office.
© Crown Copyright reserved. Licence number 10007707

19693438v3

Contents

1.0	Introduction	1
	Introduction	1
	Study Scope	1
	Methodology	3
	Report Structure	5
2.0	Policy Context	7
	Introduction	7
	National	7
	Sub-Regional Evidence Base	15
	Local Policy / Evidence Base – Core HMA Districts	20
	Local Policy / Evidence Base – Outer HMA Districts	23
	Employment Land Needs of Adjoining Boroughs	26
3.0	Socio-Economic Context	30
	Introduction	30
	Spatial Overview	30
	Economic Conditions and Trends	32
	SWOT Analysis	62
4.0	Functional Economic Market Area	64
	Defining the FEMA	64
	Conclusion on the extent of the FEMAs	74
5.0	Commercial Property Market Signals and Intelligence	75
	Introduction	75
	Employment Space	75
	Development Rates	91
	Net analysis	95
	Logistics and E-Commerce	99
	Commercial Overview	101
6.0	Business Survey	111
	Introduction	111
	Business Survey Results	111

7.0	Stage 2) Review of Strategic Employment Sites Portfolio	117
	Introduction	117
	Approach	118
	Site Assessment Results	120
	Conclusion	137
8.0	Stage 3) Future Employment Land Requirements	139
	Introduction	139
	Methodology	139
	Implications of Covid-19 on Future Growth and new Ways of Working	141
	Growth Scenarios	141
	Flexibility Factor	166
	Net Floorspace / Land Requirements	168
	Planning Requirements	172
	Planning Requirement Results	176
9.0	Demand Supply Balance	188
	Needs of Different Employment Uses	188
	The need for Strategic B8 Distribution	191
	Quantitative Balance	196
10.0	Conclusions and Policy Recommendations	217
	FEMA and Meeting Unmet Needs	217
	Employment Land Demand / Supply	218
	Qualitative Considerations	226
	Implications of the new E Class on Employment Land	227
	Managing pressures from other non-employment uses	228
	Identification of policies to support a range of employment uses	231
	Measures to facilitate development across Greater Nottingham	232

1.0 Introduction

Introduction

- 1.1 Lichfields has been commissioned to undertake an Employment Land Needs Study [ELNS] covering the Nottingham Core Housing Market Area [HMA] and Nottingham Outer HMA, which assesses the future economic development needs of the 8 authorities up to 2038. The study will not only inform the Nottingham Core HMA's review of the Aligned Core Strategies and preparation of new Part 1 Local Plans, but also the Nottingham Outer HMAs Local Plan Reviews in due course.
- 1.2 The ELNS is also critical to enabling authorities within the two HMAs to promote sufficient employment opportunities to help sustain and support major new housing development. In this context, Lichfields has approached the methodology to the ELNS based on the requirements of the National Planning Policy Framework [NPPF] and Planning Practice Guidance [PPG] and, where appropriate, combined work stages to create efficiencies.

Study Scope

- 1.3 As required by paragraph 33 of National Planning Policy Framework [NPPF], the constituent authorities of the Nottingham Core HMA have begun to prepare Local Plan Reviews. Broxtowe, Gedling, Nottingham City and Rushcliffe are jointly preparing the Greater Nottingham Strategic Plan. Separately, Erewash is preparing its own Local Plan Review. Both Local Plan Reviews are at an early stage in the plan-making process – exploring 'options for growth'.
- 1.4 In the Nottingham Outer HMA, the three authorities have already begun or completed their Local Plan Reviews; Newark's is ongoing; Mansfield adopted its Local Plan in September 2020; and Ashfield is due to publish a Draft Local Plan later this year. In due course, all authorities will be required to produce new style Local Plans in light of the Government's proposed changes to the planning system outlined in the recent White Paper.
- 1.5 This 'fundamental reform' of the planning system could include Local Plans identifying land under three categories – *Growth* areas suitable for substantial development, and where outline approval for development would be automatically secured for forms and types of development specified in the Plan; *Renewal* areas suitable for some development; and *Protected* areas where development is restricted. The White Paper's proposals allow 30 months for new Local Plans to be in place, so the Government is expecting the new style Local Plans to be in place by the end of this Parliament (i.e. by 2024).
- 1.6 In this context, the ELNS will form a critical part of the evidence base informing the preparation of Local Plan Reviews across the study area and should draw on the previous work undertaken; namely, the Employment Land Forecasting Study Nottingham Core HMA and Nottingham Outer HMA. The objective of this ELNS is therefore to provide the Commissioning Group with an up to date understanding of future requirements for employment land, at both the Functional Economic Market Area [FEMA] and constituent authority level, over

the period to 2038 and provide recommendations about the quantity and quality of sites.

- 1.7 The scope of this ELNS includes consideration of economic development based upon the typologies set out in the Former 'B' Use Classes as outlined below, but drawing on other evidence base information that is available to ensure that there is consideration of other (non B-use) industries insofar as they form economic and employment growth opportunities:
- **Office:** including offices in Eg(i)– former B1(a) - Use Class and research & development in Eg(ii) – former B1(b) - Use Class.
 - **Industrial:** including light industrial in Eg(iii)– former B1(c) - Use Class and industrial and manufacturing space in B2 Use Class.
 - **Distribution:** including storage and distribution, warehousing and wholesale uses typically in B8 Use Class.
- 1.8 References to 'employment space/uses' and 'employment-based sectors' refer to all the above uses.
- 1.9 It should be noted that there are a variety of factors and drivers to consider when objectively assessing the business context and needs for a local economy. The study uses a combination of quantitative and qualitative analysis to examine these issues in the context of the Nottingham Core and Outer HMAs and synthesises this analysis to draw overall conclusions and policy implications for long-term planning across the sub-region.
- 1.10 An important consideration for any technical work of this type is that the study is inevitably a point-in-time assessment. The study post-dates the outcome of the first lockdown due to the health crisis, which commenced in March 2020. However, the two more recent lockdowns (November 2020 and January 2021) and the Brexit deal have not been included within the econometric forecasts used in this report (which are dated September 2020). The qualitative factors and the engagement with the stakeholders capture these more recent developments.
- 1.11 The ELNS will need to align with current and emerging planned housing growth, as well as other economic policy documents and employment-related development on the fringes of the FEMAs, to ensure the evidence dovetails together.
- 1.12 To this end, the study:
- 1 Provides an up-to-date and robust evidence base to inform options for employment growth (beyond total numbers) to underpin the land proposals in the Local Plan Reviews being undertaken by the 8 authorities;
 - 2 Sets out the economic context which frames the ELNS including the dynamics of the commercial and industrial market;
 - 3 Assesses the requirement for specific sector-led economic growth relevant to the study area;
 - 4 Identifies the future demand over the plan period 2018-2038, based on both past trends as well as economic and household projection forecasts within

the context of the FEMAs and identifies where gaps exist in both quantitative and qualitative terms;

- 5 Demonstrates linkages between the economic analysis and the emerging local housing need requirements and how it will be drawn together to inform the overall policy conclusions;
- 6 Sets out the NPPF and PPG; the Government’s Industrial Strategy: Building a Britain fit for the future; as well as the D2N2 Local Enterprise Partnership’s [LEP] Strategic Economic Plan Vision and other relevant strategies, including the Economic Recovery Report.
- 7 Engages with all relevant stakeholders including the D2N2, the Development Corporation, HS2, education providers, local business and business groups, the Chamber of Commerce developers, land promoters, and local property agents.

Methodology

1.13 The Government has updated its Planning Practice Guidance [PPG] on how the need for housing and economic development should be assessed. The original 2014 iteration replaced the previous Office of the Deputy Prime Minister [ODPM] Employment Land Reviews: Guidance Note from 2004 (although this arguably remains a source of good practice). The 2019 version of the PPG¹ has reintroduced its methodology for assessing economic development needs. It states that plan makers should liaise closely with the business community to understand their current and potential future requirements².

1.14 Plan-makers should also assess:

- the best fit functional economic market area [FEMA];
- the existing stock of land within the area - this will indicate a baseline for land in employment uses;
- the recent pattern of employment land supply and loss – for example based on extant planning permissions and planning applications (or loss to permitted development);
- market demand – sourced from market intelligence from local data and discussions with developers and property agents, recent surveys of business needs or engagement with business and economic forums including locational and premises requirements of particular types of business;
- wider market signals – relating to economic growth, diversification and innovation; and,
- any evidence of market failure – such as physical or ownership constraints that prevent the employment site being used effectively.

1.15 In terms of using market signals to help forecast future needs, the PPG³ advises that a range of data which is current and robust should be used, such as:

- sectoral and employment forecasts and projections (labour demand);

¹ Practice Guidance Reference 2a-025-20190220

² Practice Guidance Reference 2a-026-20190220

³ Practice Guidance Reference 2a-026-20190220

- demographically derived assessments of future employment needs (labour supply techniques);
- analysis based on the past take-up of employment land and property and/or future property market requirements; and,
- consultation with relevant organisations, studies of business trends, and monitoring of business, economic and employment statistics.

1.16 In terms of how market demand can be analysed, the PPG⁴ advises that plan makers should note that:

“The available stock of land can be compared with the particular requirements of the area so that ‘gaps’ in local employment land provision can be identified.

It is important to consider recent employment land take up and projections (based on past trends) and forecasts (based on future scenarios) and identify occurrences where sites have been developed for specialist economic uses. This will help to provide an understanding of the underlying requirements for office, general business and warehousing sites, and (when compared with the overall stock of employment sites) can form the context for appraising individual sites.

Analysing supply and demand will allow policy makers to identify whether there is a mismatch between quantitative and qualitative supply of and demand for employment sites. This will enable an understanding of which market segments are over-supplied to be derived and those which are undersupplied. Authorities will need to take account of business cycles and make use of forecasts and surveys to assess employment land requirements.”

1.17 The PPG⁵ states that when translating employment and output forecasts into land requirements there are four key relationships which need to be quantified:

- 1 Standard Industrial Classification sectors to use classes;
- 2 Standard Industrial Classification sectors to type of property;
- 3 Employment to floorspace (employment density); and,
- 4 Floorspace to site area (plot ratio based on industry proxies).

1.18 Two new sections were added to the economic needs section of the PPG in 2019. The first of these relates to how authorities can assess need and allocate space for logistics⁶. The PPG states that where a need for such facilities may exist, strategic policy-making authorities should collaborate with other authorities, infrastructure providers and other interests to identify the scale of need across the relevant market areas. It goes on to state that a range of up-to-date evidence may have to be considered in establishing the appropriate amount, type and location of provision, including market signals, anticipated changes in the local population and the housing stock as well as the local business base and infrastructure availability.

⁴ Practice Guidance Reference 2a-029-20190220

⁵ Practice Guidance Reference 2a-030-20190220

⁶ Practice Guidance Reference 2a-031-20190220

- 1.19 The second entirely new section relates to how specific locational requirements of specialist or new sectors can be addressed⁷. This section states that when assessing what land and policy support may be needed for different employment uses, it will be important to understand whether there are specific requirements in the local market which affect the types of land or premises needed. *“These needs are often more qualitative in nature and will have to be informed by engagement with businesses and occupiers within relevant sectors”*.
- 1.20 This study’s methodology conforms to the requirements of the Framework and the updated PPG and is summarised in Figure 1.1.

Figure 1.1 Employment Land Methodology

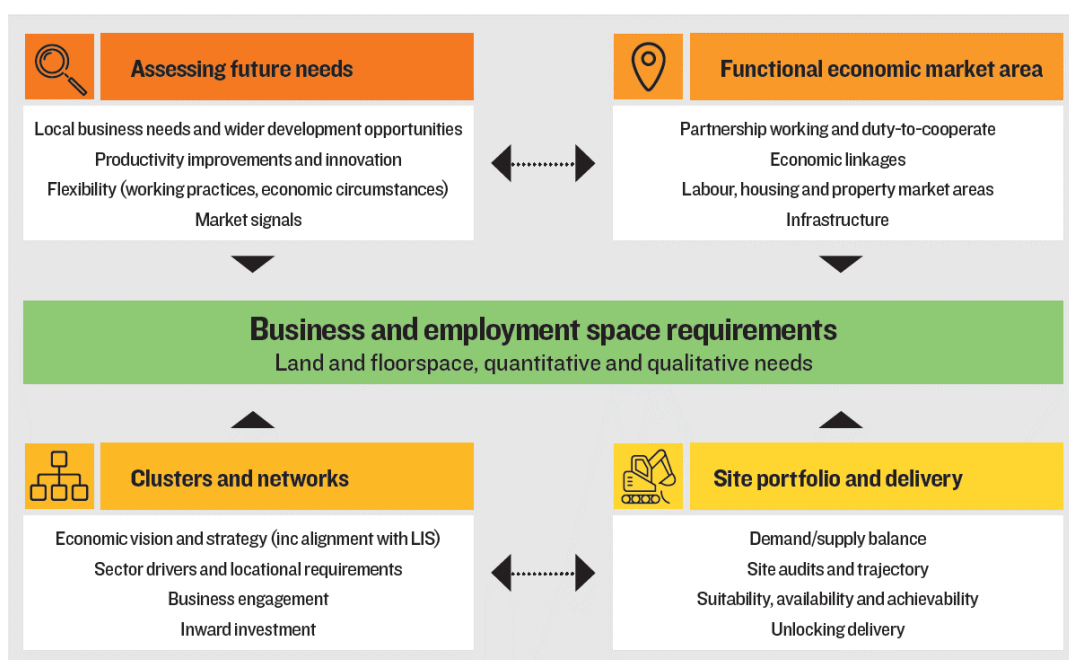

Source: Lichfields

Report Structure

- 1.21 The report is structured as follows:
- **Section 2 sets out the policy context**, including a review of relevant national and local policy documents, employment studies and economic development strategies;
 - **Section 3 outlines the socio-economic context** including current economic conditions and trends that may affect future needs for employment space;
 - **Section 4 assesses the extent to which the two HMAs form self-contained FEMAs**;
 - **Section 5 outlines the commercial property market**. This comprises a review of the local commercial property market, including the supply of and demand for different types of employment space within the Nottingham sub-region and the needs of the different market segments. It also provides

⁷ Practice Guidance Reference 2a-032-20190220

an overview of employment space across the sub-region, including the mix of uses, development rates, completions and losses, supply and demand and the needs of different market segments

- **Section 6 reports the key findings from an online Business Survey;**
- **Section 7 reviews the existing portfolio of strategic employment land and premises** in the 8 local planning authorities [LPAs] against defined criteria including market attractiveness and the ability to meet future needs;
- **Section 8 assesses the future requirement for Employment Space** including estimates of future employment space requirements for office, industrial and distribution sectors in quantitative terms, drawing on employment forecasts and other factors;
- **Section 9 assesses the balance between current land supply and future needs**, an assessment of the balance between existing land supply and future requirements in both quantitative and qualitative terms; and,
- **Section 10 summarises the key conclusions** of the study along with policy recommendations to support the existing and future site portfolio and maximise future economic growth in the 8 LPAs that comprise the Core and Outer Nottingham HMAs.

2.0 Policy Context

Introduction

- 2.1 This section provides a summary of the relevant policies relating to employment land and economic development within the Nottingham Core HMA and the Nottingham Outer HMA.

National

National Planning Policy Framework

- 2.2 The revised National Planning Policy Framework [NPPF] was published in February 2019. The Framework sets out the Government's economic, environmental and social planning policies for England. The Framework (in paragraph 7) states that the purpose of the planning system is to contribute to the achievement of sustainable development. It states in paragraph 8 that achieving sustainable development means that the planning system has three over-arching objectives, which are interdependent and need to be pursued in mutually supportive ways: economic, social and environmental. The economic objective is to help build a strong, responsive and competitive economy, by ensuring that sufficient land of the right types is available in the right places and at the right time to support growth, innovation and improved productivity; and by identifying and coordinating the provision of infrastructure.
- 2.3 The NPPF (February 2019) outlines that plans and decisions should apply a presumption in favour of sustainable development. Paragraph 11b states that for plan-making this means that:
- “a) plans should positively seek opportunities to meet the development needs of their area, and be sufficiently flexible to adapt to rapid change;*
- b) strategic policies should, as a minimum, provide for objectively assessed needs for housing and other uses, as well as any needs that cannot be met within neighbouring areas⁵, unless:*
- i. the application of policies in this Framework that protect areas or assets of particular importance provides a strong reason for restricting the overall scale, type or distribution of development in the plan area; or*
- ii. any adverse impacts of doing so would significantly and demonstrably outweigh the benefits, when assessed against the policies in this Framework taken as a whole.”*
- 2.4 Paragraph 20 states that strategic policies should set out an overall strategy for the pattern, scale and quality of development and make sufficient provision for a range of uses, including employment and other commercial development.

- 2.5 Section 6 of the Framework summarises how the Planning System should help build a strong competitive economy:
- “Planning policies and decisions should help create the conditions in which businesses can invest, expand and adapt. Significant weight should be placed on the need to support economic growth and productivity, taking into account both local business needs and wider opportunities for development. The approach taken should allow each area to build on its strengths, counter any weaknesses and address the challenges of the future. This is particularly important where Britain can be a global leader in driving innovation, and in areas with high levels of productivity, which should be able to capitalise on their performance and potential.”* [paragraph 80]
- 2.6 The Framework [paragraph 81] indicates that LPAs are required to ensure that Local Plan policies set out a clear economic vision and strategy which positively and proactively encourages sustainable economic growth, having regard to Local Industrial Strategies and other local policies for economic development and regeneration. They should set criteria, or identify strategic sites, for local and inward investment to match the strategy and to meet anticipated needs over the plan period, and seek to address potential barriers to investment, such as inadequate infrastructure, services or housing, or a poor environment. The Framework also requires planning policies to be sufficiently flexible to accommodate needs not anticipated in the plan, allow for new and flexible working practices (such as live-work accommodation), and to enable a rapid response to changes in economic circumstances.
- 2.7 Furthermore, planning policies and decisions should recognise and address the specific locational requirements of different sectors. The Framework states that:
- “This includes making provision for clusters or networks of knowledge and data-driven, creative or high technology industries; and for storage and distribution operations at a variety of scales and in suitably accessible locations.”* [paragraph §82].
- 2.8 Paragraphs 83 and 84 of the Framework focus on supporting a prosperous rural economy. Planning policies and decisions are required to enable the sustainable growth and expansion of all types of business in rural areas, both through conversion of existing buildings and well-designed new buildings. It assumes that some sites needed to meet local business needs in rural areas may have to be found adjacent to, or beyond, existing settlements, hence why it is important to ensure that development is sensitive to its surroundings. The use of previously developed land, and sites that are physically well-related to existing settlements, should be encouraged where suitable opportunities exist.
- 2.9 Offices are defined as a ‘main town centre use’ (Annex 1) in the Framework. As such, and in accordance with the sequential test, offices should be located in town centres, then in edge of centre locations; and only if suitable sites are not available should out of centre sites be considered [paragraph 86]. This sequential approach does not, however, apply to small scale rural offices [paragraph 88].

- 2.10 The Framework states that LPAs should ensure an integrated approach to considering the location of housing, economic uses and community facilities and services [paragraph 92(e)].
- 2.11 In line with the general thrust of the Framework which seeks to significantly boost the supply of homes, Chapter 11, *‘Making effective use of land’* stipulates that planning policies should promote an effective use of land in meeting the need for homes and other uses [paragraph 117]. In particular, this requires LPAs to promote and support the development of under-utilised land and buildings, especially where this would help to meet housing needs [paragraph 118]. In particular, paragraph 120 encourages LPAs to adapt planning decisions and policies to reflect “*changes in the demand for land*” by stating that:
- “Planning policies and decisions need to reflect changes in the demand for land. They should be informed by regular reviews of both the land allocated for development in plans, and of land availability. Where the LPA considers there to be no reasonable prospect of an application coming forward for the use allocated in a plan:*
- a) they should, as part of plan updates, reallocate the land for a more deliverable use that can help to address identified needs (or, if appropriate, deallocate a site which is undeveloped)...”*
- 2.12 Paragraph 121 of the Framework takes this theme further by stating that:
- “LPAs should also take a positive approach to applications for alternative uses of land which is currently developed but not allocated for a specific purpose in plans, where this would help to meet identified development needs. In particular, they should support proposals to:*
- a) use retail and employment land for homes in areas of high housing demand, provided this would not undermine key economic sectors or sites or the vitality and viability of town centres, and would be compatible with other policies in this Framework...”*
- 2.14 Ultimately, the Framework requires local authorities to have up-to-date and comprehensive evidence to inform their judgments about the need for, and relative importance of, the employment land in their areas, particularly in the face of added pressure for release to other uses.
- 2.15 The Government is currently consulting on draft revisions to the Framework⁸. A fuller review of the Framework is likely to be required in due course, depending on the implementation of the government’s proposals for wider reform of the planning system as set out in the White Paper *‘Planning for the Future’* (August 2020).
- 2.16 Proposed textual changes relating to employment include changes to paragraph 11 a):
- 2.17 a) all plans should promote a sustainable pattern of development that seeks to meet the development needs of their area; align growth and infrastructure;

⁸ <https://www.gov.uk/government/consultations/national-planning-policy-framework-and-national-model-design-code-consultation-proposals>

improve the environment; mitigate climate change (including by making effective use of land in urban areas) and adapt to its effects;

2.18 Paragraph 22 is also proposed to be amended to extend the Plan’s vision to at least 30, rather than 15 years:

“Where larger-scale development such as new settlements form part of the strategy for the area, policies should be set within a vision that looks further ahead (at least 30 years), to take into account the likely timescale for delivery.”

2.19 No textual changes are currently proposed to Section 6 ‘Building a strong, competitive economy’.

National Planning Practice Guidance

2.20 On 6th March 2014 CLG launched the Planning Practice Guidance [PPG] web-based resource⁹. This website brings together many areas of English planning guidance into a new format, linked to the Framework and replaces the previous Office of the Deputy Prime Minister [ODPM] *Employment Land Reviews: Guidance Note* from 2004 (although this arguably remains a source of good practice).

2.21 The PPG has two much-shortened sections in ‘Plan Making’:

What are the steps in gathering evidence to plan for business?

Strategic policy-making authorities will need a clear understanding of business requirements in their area. The steps in building up this evidence include:

- *working together with county and neighbouring authorities, Mayors, combined authorities and with Local Enterprise Partnerships to define the most appropriate geography to prepare policies for employment;*
- *preparing and maintaining a robust evidence base to understand both existing business needs and likely changes in the market, with reference to local industrial strategies where relevant; and*
- *engaging with the business community to understand their changing needs and identify and address barriers to investment, including a lack of housing, infrastructure or viability.¹⁰*

How can authorities use this evidence base to plan for business?

Authorities can use this evidence to assess:

- *the need for land or floorspace for economic development, including both the quantitative and qualitative needs for all foreseeable types of economic activity over the plan period, including for retail and leisure development;*
- *the existing and future supply of land available for economic development and its suitability to meet the identified needs. This should be undertaken at the same time as, or combined with, Strategic Housing Land Availability*

⁹ <http://planningguidance.planningportal.gov.uk/>

¹⁰ 61-040-20190315

Assessments and should include a reappraisal of the suitability of previously allocated land.

- the likely availability and achievability of employment-led development, taking into account market signals;*
- the role, capacity and function of town centres and the relationship between them, including any trends in the performance of centres;*
- locations of deprivation which may benefit from planned remedial action; and*
- the needs of the farming and food production industries, including the location and extent of the best and most versatile agricultural land, and the ways in which planning could support investment in those industries¹¹.”*

2.22 The PPG has updated its guidance on the assessment of housing and economic development. It states that plan makers should liaise closely with the business community to understand their current and potential future requirements¹².

2.23 Plan-makers should also assess:

- the best fit functional economic market area [FEMA];
- the existing stock of land for employment uses within the area;
- the recent pattern of employment land supply and loss – for example based on extant planning permissions and planning applications (or losses to permitted development);
- evidence of market demand (including the locational and premises requirements of particular types of business) - sourced from local data and market intelligence, such as recent surveys of business needs, discussions with developers and property agents and engagement with business and economic forums;
- wider market signals relating to economic growth, diversification and innovation; and,
- any evidence of market failure – such as physical or ownership constraints that prevent the employment site being used effectively.

2.24 In terms of using market signals to help forecast future needs, the PPG¹³ advises that a range of data which is current and robust should be used, such as:

- sectoral and employment forecasts and projections which take account of likely changes in skills needed (labour demand);
- demographically derived assessments of current and future local labour supply (labour supply techniques);
- analysis based on the past take-up of employment land and property and/or future property market requirements; and,

¹¹Practice Guidance Reference 61-041-20190315

¹² Practice Guidance Reference 2a-026-20190220

¹³ Practice Guidance Reference 2a-027-20190220

- consultation with relevant organisations, studies of business trends, an understanding of innovative and changing business models, particularly those which make use of online platforms to respond to consumer demand and monitoring of business, economic and employment statistics.

2.25 In terms of how market demand can be analysed, the PPG¹⁴ advises that plan makers should note that:

“The available stock of land can be compared with the particular requirements of the area so that ‘gaps’ in local employment land provision can be identified.

It is important to consider recent employment land take up and projections (based on past trends) and forecasts (based on future scenarios), and to identify instances where sites have been developed or sought for specialist economic uses. This will help to provide an understanding of the underlying requirements for office, general business and distribution space, and (when compared with the overall stock of employment sites) can form the context for appraising individual sites.

Analysing supply and demand will allow policy makers to identify whether there is a mismatch between quantitative and qualitative supply of and demand for employment sites. This will enable an understanding of which market segments are over-supplied to be derived and those which are undersupplied”.

2.26 In order to derive employment land requirements, the PPG¹⁵ states that when translating employment and output forecasts into land requirements there are four key relationships which need to be quantified:

- Standard Industrial Classification sectors to use classes;
- Standard Industrial Classification sectors to type of property;
- Employment to floorspace (employment density); and,
- Floorspace to site area (plot ratio based on industry proxies).

2.27 The PPG has also added in two new sections on how authorities can assess need and allocate space for logistics¹⁶ and how specific locational requirements of specialist or new sectors be addressed¹⁷.

2.28 Regarding the former, the PPG recognises that the logistics industry plays a critical role in enabling an efficient, sustainable and effective supply of goods for consumers and businesses, as well as contributing to local employment opportunities, and has distinct locational requirements that need to be considered in formulating planning policies (separately from those relating to general industrial land). To address this, the PPG states that:

¹⁴ Practice Guidance Reference 2a-029-20190220

¹⁵ Practice Guidance Reference 2a-030-20190220

¹⁶ Practice Guidance Reference 2a-031-20190722

¹⁷ Practice Guidance Reference 2a-032-20190722

“Strategic facilities serving national or regional markets are likely to require significant amounts of land, good access to strategic transport networks, sufficient power capacity and access to appropriately skilled local labour. Where a need for such facilities may exist, strategic policy-making authorities should collaborate with other authorities, infrastructure providers and other interests to identify the scale of need across the relevant market areas. This can be informed by:

- engagement with logistics developers and occupiers to understand the changing nature of requirements in terms of the type, size and location of facilities, including the impact of new and emerging technologies;*
- analysis of market signals, including trends in take up and the availability of logistics land and floorspace across the relevant market geographies;*
- analysis of economic forecasts to identify potential changes in demand and anticipated growth in sectors likely to occupy logistics facilities, or which require support from the sector; and*
- engagement with Local Enterprise Partnerships and review of their plans and strategies, including economic priorities within Local Industrial Strategies.*

Strategic policy-making authorities will then need to consider the most appropriate locations for meeting these identified needs (whether through the expansion of existing sites or development of new ones).”

2.29 Regarding the former, the PPG states that when assessing what land and policy support may be needed for different employment uses, it will be important to understand whether there are specific requirements in the local market which affect the types of land or premises needed:

“Clustering of certain industries (such as some high tech, engineering, digital, creative and logistics activities) can play an important role in supporting collaboration, innovation, productivity, and sustainability, as well as in driving the economic prospects of the areas in which they locate. Strategic policy-making authorities will need to develop a clear understanding of such needs and how they might be addressed taking account of relevant evidence and policy within Local Industrial Strategies. For example, this might include the need for greater studio capacity, co-working spaces or research facilities.

These needs are often more qualitative in nature and will have to be informed by engagement with businesses and occupiers within relevant sectors.”

Build Back Better – Our Plan for Growth

2.30 The March 2021 Budget was accompanied by the publication of *“Build Back Better: our plan for growth”*, a policy paper which sets out the Government’s plans to support economic growth through investment in infrastructure, skills and innovation. It provides a new framework that supersedes the 2017 Industrial Strategy as a central policy reference point.

2.31 The plan for growth focuses on three pillars of investment to act as the foundation on which to build the economic recovery, uniting and levelling up the country:

- 1 *“High quality **infrastructure** is crucial for economic growth, boosting productivity and competitiveness. The UK has historically underinvested in infrastructure, but we are fixing that, starting with £100 billion of capital investment in 2021-22.*
- 2 *The best way to improve people’s life chances is to give them the **skills** to succeed. The UK has a strong foundation of advanced skills, but lags behind international comparators on technical and basic adult skills. The government is transforming Further Education, encouraging lifelong learning through the Lifetime Skills Guarantee, and building an apprenticeships revolution.*
- 3 ***Innovation** drives economic growth and creates jobs. The UK has a world-leading research base, which will be boosted by the government’s significant uplift in R&D investment and the creation of the Advanced Research & Invention Agency to fund high-risk, high-reward research. However, too few businesses are able to access the tools they need to translate new ideas into new products and services and to challenge established businesses. We will make the UK the best ecosystem in the world for starting and growing a business. That means having the best access to capital, skills and ideas, as well as a smart and stable regulatory framework.”*

2.32 The paper details a series of new funding arrangements and confirms that the long-awaited UK Shared Prosperity Fund will arrive in 2022 to replace European Union structural funds as they expire after 2022-23.

2.33 The Infrastructure Core Pillar will be supported by the following interventions:

- Stimulate short-term economic activity and drive long-term productivity improvements via record investment in broadband, roads, rail and cities, as part of capital spending plans worth £100 billion next year.
- Connect people to opportunity via the UK-wide Levelling Up Fund and UK Shared Prosperity Fund, as well as the Towns Fund and High Street Fund, to invest in local areas.
- Help achieve net zero via £12 billion of funding for projects through the Ten Point Plan for a Green Industrial Revolution.
- Support investment through the new UK Infrastructure Bank which will ‘crowd-in’ private investment to accelerate progress to net zero, helping to level up the UK. This will invest in local authority and private sector infrastructure projects, as well as providing an advisory function to help with the development and delivery of projects.

2.34 Page 38 of the Plan states that the Integrated Rail Plan for the Midlands and the North will ensure that Phase 2b of HS2, Northern Powerhouse Rail and other planned rail investments in the North and Midlands are scoped and delivered in an integrated way, bringing transformational rail improvements more quickly and to more places.

2.35 The growth is focused on driving the Government’s levelling up agenda, which aims to regenerate struggling towns in all parts of the UK via the UK Shared Prosperity Fund and the UK-wide Levelling Up Fund, with Freeports across the

country including the freeport based around the East Midlands Airport and Gateway Industrial Cluster [EMAGIC] in North West Leicestershire, Uniper's Ratcliffe-on-Soar Power Station site in Rushcliffe Borough in Nottinghamshire and the East Midlands Intermodal Park (EMIP) in South Derbyshire.

- 2.36 The Plan goes on to set out the Government's long-term vision for every region and nation to have at least one globally competitive city at its heart to help drive prosperity. This includes City and Growth Deals, £4.2 billion in intra-city transport settlements from 2022-23, and continued Transforming Cities Fund investment to 2022-23. It also aims to catalyse centres of excellence, supporting individuals across the country to access jobs and opportunities by ensuring digital and transport connectivity, by establishing a new UK Infrastructure Bank in the North of England and by relocating 22,000 Civil Service roles out of London.

Sub-Regional Evidence Base

Refresh of the D2N2 LEP Strategic Economic Plan Vision 2030 [SEP]

- 2.37 D2N2 is a Local Enterprise Partnership [LEP] for Derby, Derbyshire, Nottingham and Nottinghamshire. The LEP plays a central role in deciding the economic priorities and undertaking activities to drive economic growth and create local jobs.
- 2.38 The D2N2 LEP Strategic Economic Plan: Vision 2030 is a comprehensive economic strategy for the region, forming the basis for future investment decisions by the LEP and its partners. The plan sets out the blueprint for growth over the next decade and outlines targets aimed at: bringing up to £9 billion in added value to the D2N2 economy, boosting the D2N2's productivity into the top 25% in Europe, raising earnings, narrowing inequality, and sharing prosperity across all parts of the two cities and counties.
- 2.39 The delivery mechanism for the strategy is through the implementation of 8 'Key Actions'. The strategy outlines that these 'Key Actions' will help the region achieve a transformed high-value economy by 2030;¹⁸ they are listed below:
- 1 Creating a strong LEP and Local Industrial Strategy;
 - 2 Refocusing the D2N2 Growth Hub to enhance business productivity;
 - 3 Driving productivity and growth in priority sectors;
 - 4 Delivering careers inspiration for the current and future workforce;
 - 5 Supporting inclusion and progression in the labour market;
 - 6 Developing skills and leadership for productivity growth;
 - 7 Securing investment to deliver world class infrastructure and connectivity; and,
 - 8 Maximising the economic benefits of HS2 in the D2N2 Economy.

¹⁸ D2N2 (2019): *D2N2 STRATEGIC ECONOMIC PLAN: Vision 2030*

2.40 The plan also identifies 11 priority sectors important to the D2N2 Economy, that may need different interventions in order to effectively contribute to the productivity growth; these sectors are listed below:

- 1 Transport Equipment Manufacturing;
- 2 Food & Drink Manufacturing;
- 3 Life Sciences;
- 4 Creative & Digital;
- 5 Visitor Economy;
- 6 Logistics & E-Commerce;
- 7 Construction;
- 8 Extractive Industries;
- 9 Retail;
- 10 Health/Social Care; and,
- 11 Profession/Business Services.

2.41 The plan splits these priority sectors into Science and Innovation Core Sectors and Opportunity Sectors. The former seeks to exploit the D2N2's competitive advantage in some sectors, with the Transport Equipment Manufacturing, Food & Drink Manufacturing and Life Sciences sectors all offering global opportunities for growth. The latter relates to remaining sectors, those which are important to the local economy in different ways and will require varied interventions to support productivity growth. The plan outlines that raising productivity and pay within these opportunity sectors is key to promoting 'inclusive growth'.

Draft D2N2 Local Industrial Strategy [LIS]

2.42 The Draft D2N2 Local Industrial Strategy [LIS] was submitted to the government in March 2020 and covers the same time period as the Vision 2030. It sets out a limited number of focused, evidence-backed priorities which will help drive the region towards the vision and targets set out in the SEP.

2.43 The strategy is underpinned by the following three guiding principles [GPs], that focus on '*addressing the issues impeding clean, productive and inclusive growth across the D2N2 region*'¹⁹:

- 1 **Upskilling for productivity:** The LIS aims to lead a bold new way of bringing together the education and skills frameworks to support businesses to deliver the talent for the current and next generation of businesses;
- 2 **Clean Growth:** The LIS also aims to lead the most ambitious carbon turn-around in the country; and,
- 3 **Connectivity and Inclusion:** The LIS targets the delivery connectivity-led growth to all parts of the region.

¹⁹ D2N2 (2020): *DRAFT LOCAL INDUSTRIAL STRATEGY*

- 2.44 The strategy plans to redress the regional productivity lag by upskilling more of the population at a quicker rate and providing the skills and space required for businesses to scale and develop. This, it hopes, will make the people and businesses of the region resilient to the potential impacts of Brexit and ongoing globalisation, automation and digitisation, changing workforce demographics and climate change.
- 2.45 As the closure of carbon-emitting power stations continues, the strategy focuses on utilising this situation as an opportunity to champion new zero-carbon energy systems and related business clusters. This involves the decarbonising of all the region's key sectors and nurturing the growth of low and zero-carbon focused business.
- 2.46 The strategy also supports inclusive growth across the whole region. This targets particular growth in sector strengths in more disadvantaged communities, such as the logistics sector around Mansfield. Business activity will be developed at sites along the M1 motorway and demand for employment space in rural communities will be addressed through growth and expansion.
- 2.47 Inclusive growth will be achieved whilst supporting the continued growth of the city of Nottingham through investment in its sectoral strengths and better utilisation of investment opportunities, with a prioritisation on the development of Grade A commercial space.

East Midlands Northern Sub Regional Employment Land Review 2009

- 2.48 An Employment Land Review [ELR], published in 2009, provided an analysis of employment land demand and supply in the Northern Sub-Region. This sub-region consisted of seven district and borough authorities, namely Ashfield (excluding Hucknall), Bassetlaw, Bolsover, Chesterfield, Mansfield, Newark and Sherwood and North East Derbyshire (excluding the Peak District National Park). The Study assessed the existing employment sites and employment allocations from a market and policy perspective.
- 2.49 The study examined employment growth across this sub-region up to 2026 and provides a recommendation for the amount of employment land that each district will need. The net figures for each district are set out below:
- Ashfield District: 9.9 – 34.5 ha
 - Bassetlaw District: 79.5 – 92.5 ha
 - Bolsover District: 64.3 – 84.5 ha
 - Chesterfield Borough: 29.1 – 44.4 ha
 - Mansfield District: 23.7 – 35.2 ha
 - Newark and Sherwood District: 31.0 – 52.6 ha
 - North East Derbyshire District: 36.9 – 68.2 ha
- 2.50 The above figures indicate that the Sub-Region as a whole could require between 274 – 412ha of employment land (net). The report indicates that Bassetlaw District has the highest net projection and net demand is projected to be lowest for Ashfield and Mansfield Districts.

2.51 The report sets out various trends in the Sub-Region: moderate growth in demand for B1 land, a general decline in demand for B2 land and strong growth in demand for B8 land.

Employment Land Forecasting Study [ELFS] August 2015 Nottingham Core HMA and Nottingham Outer HMA

2.52 An Employment Land Forecasting Study [ELFS] was prepared by Lichfields in August 2015 and provided evidence on economic prospects and employment land forecasts for the Nottingham Core HMA and the Nottingham Outer HMA. The study formed part of the evidence base for the emerging development plan documents of the eight commissioning authorities, helping to identify future employment land needs and guiding economic development over the period to 2033.

2.53 In terms of spatial context, the study found that the two HMAs represented a sizable economic sub-region, with diverse business sectors and comparative growth rate trends. The areas were found to benefit from good strategic transport links, which could be further extended subject to the development of HS2 hubs at locations within the sub-region. The Core HMA specifically, was found to be characterised by a highly skilled resident population who benefitted from higher wages, with the exception of Nottingham City which displayed some disparities. The Outer HMA on the other hand, was found to have lower wage levels than the Core HMA, with this indicative of the lower skill level of its population.

2.54 The report also analysed Valuation Office Agency [VOA] which indicated that the total stock of commercial office and industrial space within the Core HMA was 5.5 million sqm, of which 70% comprised industrial and warehouse space. Nottingham City in particular was found to dominate this supply, accounting for 70% of office space and 40% of industrial space within the Core HMA. The Outer HMA was found to have a total stock of nearly 3 million sqm of commercial office and industrial space, with 90% of this comprising of industrial and warehousing space.

2.55 With respect to the future employment land needs of the area, the study analysed a number of scenarios to indicate a broad scale and type of employment growth arising from different approaches in the HMA. These scenarios included a baseline scenario that reflected a forecast view of the ambient level of future growth in the economy, a 'policy on' scenario that reflected an assumption of higher future economic growth in line with region economic objectives, and a labour supply-based scenario that provided a benchmark comparison with labour demand approaches. Within the Core HMA, the study found that the office floorspace requirements range from 216,870 sqm – 501,952 sqm, with industrial land requirements ranging from 59.76 – 199.78 ha and the individual districts of the Core HMA were broken down to produce the following range of demand projections:

- **Broxtowe:** 26,482 – 59,886 sqm office floorspace; 5.28 – 43.21 ha industrial land;

- **Erewash:** 2,755 – 25,692 sqm office floorspace; 4.35-18.78 ha industrial land;
- **Gedling:** 0 - 10,445 sqm office floorspace; 13.89 – 23.36 ha industrial land;
- **Nottingham:** 149,973 – 300,235 sqm office floorspace; 19.16 – 64.92 ha industrial land; and,
- **Rushcliffe:** 37,661 – 104,973 sqm office floorspace; 17.33 – 49.51 ha industrial land.

2.56 Within the Outer HMA, the study found that the office floorspace requirements range from 161,611 sqm – 223,086 sqm, with industrial land requirements ranging from 160.18 – 284.9 ha and the individual districts of the Outer HMA can be broken down to produce the following range of demand projections:

- **Ashfield:** 41,877 – 48,470 sqm office floorspace; 47.81 – 132.13 ha industrial land;
- **Mansfield:** 23,963 - 55,713 sqm office floorspace; 39.74 - 50.55 ha industrial land; and,
- **Newark & Sherwood:** 91,192 - 113,040 sqm office floorspace; 62.60 – 74.53 ha industrial land.

Nottingham Core HMA boundary Study 2018 and Employment Land Forecasting Study

2.57 Opinion Research Services [ORS] was commissioned in 2018 by the 5 Nottingham Core HMA councils, to undertake a study to confirm the Nottingham Core HMA boundary. The purpose of the study was to confirm the boundary of the Nottingham Core HMA and Functional Economic Market Area [FEMA] based on Council boundaries.

2.58 The data analysed found that the Nottingham Core HMA authorities of Broxtowe, Gedling, Erewash, Nottingham City and Rushcliffe are all located within the same HMA and FEMA. The migration and commuting data also supported a Nottingham Outer HMA and FEMA containing Ashfield, Mansfield and Newark and Sherwood.

2.59 However, this conclusion does not prevent overlaps occurring between the areas, with Hucknall for example, falling within the Ashfield Council administrative area and the functional HMA and FEMA for the Core HMA. Despite this, the study affirms that *‘from an administrative and practical point of view it is necessary for HMAs and FEMAs to follow local authority boundaries and the five authorities in the Nottingham Core HMA and FEMA remain the most appropriate grouping²⁰’*.

Greater Nottingham Growth Options Study 2020

2.60 Broxtowe Borough Council, Derbyshire County Council, Erewash Borough Council, Gedling Borough Council, Nottingham City Council, Nottinghamshire County Council and Rushcliffe Borough Council commissioned AECOM in 2020

²⁰ ORS (2018): *Nottingham Core HMA Study 2018 – Report of Findings*, paragraph 2.40-2.41

to review options for strategic growth in Greater Nottingham outside the Main Built-Up Area.

- 2.61 This report aimed *‘to assist in deciding where and what form development should take place in order to reach the collective growth targets of the Councils in a way that best meets a range of environmental, economic, social, transport and other objectives’*²¹.
- 2.62 The study identified potential for over 7,000 hectares of strategic development and demonstrated that there are significant opportunities within each of the local authorities.

Local Policy / Evidence Base – Core HMA Districts

Broxtowe Borough

- 2.63 Broxtowe Borough Council’s Local Plan has been undertaken in two parts. Part 1 of the Local Plan (Aligned Core Strategy) was adopted in 2014 and sets out the vision, objectives, spatial strategy and the strategic policies for the Borough up to 2028. The Plan was prepared jointly with Nottingham and Gedling. The relevant policies relating to employment are set out below:
- **Policy 2 (The Spatial Strategy)** outlines that the employment strategy will protect and provide well-located employment land that continues to meet the needs of modern business in addition to providing new jobs; and,
 - **Policy 4 (Employment Provision and Economic Development)** provides a range of suitable sites for new employment, with a minimum of 34,000 sqm allocated for office development and 15 ha for industrial and warehouse uses.

- 2.64 These policies were informed by the Nottingham City Region Employment Land Study [NCRELS] (2007; updated 2009) which assessed the quantity and quality of employment land in Nottingham City, Broxtowe, Erewash, Gedling and Rushcliffe - plus the Hucknall wards in Ashfield. The policies were also informed by the Greater Nottingham Employment Background Paper (2012) which reviewed and rolled forward aspects of the NCRELS and applied to the area covered by the Broxtowe, Gedling and Nottingham City Aligned Core Strategies, the Erewash Borough Core Strategy and the Rushcliffe Core Strategy.

- 2.65 Part 2 of the Local Plan was adopted in October 2019 and provides the detailed development management policies and site allocations to accompany the Part 1 Local Plan. The relevant policy relating to employment is Policy 9 (Retention of good quality existing employment sites). This policy provides detail on the principle of allowing existing employment sites to be redeveloped. Part 2 of the Local Plan was informed by the 2015 ELFS.

Erewash Borough

- 2.66 Erewash Borough Council adopted its Core Strategy in March 2014 and it sets out the strategic spatial planning framework for the Borough and includes policies which address new housing and regeneration, economic development,

²¹ AECOM (2020): *Greater Nottingham Growth Options Study 2020*

town and local centres, green belt protection, green Infrastructure, climate change and the positive management of built and natural environment. The document was produced in broad alignment with Rushcliffe Borough Council's Local Plan Part 1 document and the Aligned Core Strategies of Broxtowe Borough, Gedling Borough and Nottingham City Councils.

2.67 The relevant policies relating to employment land are set out below:

- **Policy 2 (The Spatial Strategy)** states that significant new employment development will take place at the Stanton Regeneration Site; and,
- **Policy 4 (Employment Provision and Economic Development)** outlines that the economy of Erewash will be strengthened and diversified with new floorspace being provided across all employment sectors. The policy allocates a minimum of 42,900 sq.m of office floorspace and 10 ha of land for industrial and warehousing uses.

2.68 These policies were informed NCRELS (2007; updated 2009) and the Greater Nottingham Employment Background Paper (2012).

2.69 The Council is currently undertaking a Core Strategy Review with the Growth Options document being published in January 2020. The Council consulted on proposals to develop housing on several sites in the borough from January to July 2020 as part of this review. 17 strategic growth areas [SGA] were identified as part of the spatial growth options.

Gedling Borough

2.70 The Gedling Local Plan has been undertaken in two parts. Part 1 of the Local Plan (Aligned Core Strategy) was adopted in 2014 and sets out the strategic policy direction for future development in Gedling Borough. The Plan was prepared jointly with Nottingham and Broxtowe.

2.71 The relevant policies relating to employment land are set out below:

- **Policy 2 (The Spatial Strategy)** outlines that the employment strategy will continue to protect and provide well-located employment land that continues to meet the needs of modern business with the protected employment sites in Gedling being well placed to receive any relocating firms moving as the result of the strategy for the Regeneration Zones in Nottingham City; and,
- **Policy 4 (Employment Provision and Economic Development)** sets out how the economy of the area will be strengthened and diversified with new floorspace being provided across all employment sectors; with a minimum of 23,000 sqm allocated for office development and 10 ha for industrial and warehouse uses.

2.72 These policies were informed by the NCRELS (2007; updated 2009) and the Greater Nottingham Employment Background Paper (2012).

Part 2 of the Local Plan, Local Planning Document, includes policies to help deliver specific allocations and help in the day-to-day assessment of planning applications, and site-specific policies, allocations of non-strategic sites and

designations. The Plan was adopted in July 2018. The relevant policies relating to employment are set out below:

- **Policy LPD44 (Retention of Employment and Employment Uses)** outlines the council's strategy to protect employment sites and new employment allocations;
- **Policy LPD45 (Employment Development on Unallocated Sites)** outlines the council's strategy for further employment development outside the allocations;
- **Policy LPD46 (Expansion of Existing Uses Not in The Green Belt)** encourages the redevelopment or expansion of existing business premises; and,
- **Policy LPD71 (Employment Allocations)** which allocates specific sites for employment uses within the Borough.

Nottingham City

2.73 The Nottingham City Local Plan has been undertaken in two parts. Part 1 of the Local Plan (Aligned Core Strategy) was adopted in 2014 and sets out strategic planning policies and development principles for Nottingham City to guide development until 2028. The Plan was prepared jointly with Broxtowe and Gedling.

2.74 The relevant policies relating to employment land are set out below:

- **Policy 2 (The Spatial Strategy)** outlines the economic development will be focused in the City Centre and the Regeneration Zones, and on specific key sites; and,
- **Policy 4 (Employment Provision and Economic Development)** sets out how the economy of the area will be strengthened and diversified with new floorspace being provided across all employment sectors; with a minimum of 253,000 sqm allocated for office development and 12 ha for industrial and warehouse uses;

2.75 These policies were informed NCRELS (2007; updated 2009) and the Greater Nottingham Employment Background Paper (2012).

2.76 Part 2 of the Local Plan, The Land and Planning Policies document, was adopted in January 2020 and contains Development Management planning policies and site-specific land allocations. The relevant policies relating to employment are set out below:

- **Policy EE1 (Providing a Range of Employment Sites)** outlines that provision will be made for a minimum of 253,000 square metres for office floorspace and around 25 hectares for other employment uses in the district; and,
- **Policy EE2 (Safeguarding Existing Business Parks / Industrial Estates)** outlines that within major business parks and industrial estates, employment sites or employment premises will only be granted permission for employment uses;

2.77 Part 2 of the Local Plan was informed by the 2015 ELFS.

Rushcliffe Borough

2.78 The Rushcliffe Borough Local Plan has been undertaken in two parts. Part 1 of the Local Plan (Core Strategy) was adopted in December 2014 and establishes the strategic approach to new development in the Borough whilst identifying the main strategic allocations. The planning policies included in the plan are aligned with Erewash Borough Council's Core Strategy and the policies of the Nottingham, Broxtowe and Gedling Aligned Core Strategy.

2.79 The relevant policies relating to employment land are set out below:

- **Policy 3 (Spatial Strategy)** outlines the locations for significant employment provision within Rushcliffe;
- **Policy 5 (Employment provision and economic development)** outlines how the economy of Rushcliffe will be strengthened and diversified with new floorspace being provided across all employment sectors. The policy allocates a minimum of 67,900 sqm of office floorspace and 20 ha of land for industrial and warehouse use;

2.80 These policies were informed NCRELS (2007; updated 2009) and the Greater Nottingham Employment Background Paper (2012).

2.81 Part 2 of the Local Plan, Land and Planning Policies, was adopted in October 2019 and identified non-strategic allocations and designations and set out more detailed policies for use in the determination of planning applications. The relevant policy relating to employment is Policy 15 (Employment Development) which outlines the sites allocated for employment development. The Plan was informed by the 2015 ELFS.

Local Policy / Evidence Base – Outer HMA Districts

Ashfield District

2.82 Ashfield District Council is currently preparing a new Local Plan. The draft Local Plan was due for publication later in 2020, but there is currently an interlude due to the uncertainties resulting from the Coronavirus pandemic and the Government Consultation on '*Changes to the current planning system: Consultation on changes to planning policy and regulations*' (August 2020). The consultation was based on proposed changes to the current Standard Methodology [SM]. The significant increase that may arise from the proposed changes to the SM would have serious consequences for the Plan's overall development strategy.

2.83 Given this, the saved policies of Ashfield's Local Plan (adopted in 2002)²², remains the principal local planning framework for the District.

2.84 The saved policies relating to employment land are set out below:

- **Policy EM1** allocates a total of 194.3 hectares (gross) for employment development across 35 sites in the District;

²² Ashfield District Council (2002): *Ashfield Local Plan: Saved Policies*

- **Policy EM2** relates to the Open Air Testing Zone at Rolls Royce, Hucknall and states that only testing facilities that specifically require an open air location will be permitted where they cannot be development in the main urban area for technical or environmental reasons (albeit, this Policy has been superseded by planning permission (v/2013/0123) for a mixed use development comprising 900 dwellings and a business park - ‘Harrier Park’);
- **Policy EM4** states that proposals for alternative uses of allocated employment sites will not be permitted; and,
- **Policy EM5** relates to the protection of existing employment sites and buildings, stating that proposals which would cause the loss of existing employment sites or buildings will only be permitted where specified criteria can be met.

2.85 As part of the Local Plan preparation process, the Council is also preparing a Strategic Housing and Employment Land Availability Assessment [SHELAA]. The SHELAA will identify land that could be used to meet housing or employment requirements, over the minimum 15-year Local Plan period. The Council has undertaken a call for sites, inviting members of the local community, landowners and organizations to put forward sites within Ashfield for assessment and consideration. It is anticipated the SHELAA will be published in early Spring.

Mansfield District

2.86 In September 2020, Mansfield District Council adopted the Mansfield District Local Plan 2013-2033²³. The Local Plan replaced all the remaining saved policies of the 1998 Mansfield District Local Plan and now forms part of the statutory development plan. The relevant policies relating to employment are set out below:

- **Policy S2 The Spatial Strategy** sets out the spatial strategy for the district including the settlement hierarchy approach to employment growth and the amount of employment land which will be provided (at least 41 ha between 2013 to 2033).
- **Policy E1 (Enabling economic development)** states that proposals for economic development will be supported, especially when they involve:
 - (a) Major inward investment into the district;
 - (b) The creation of substantial new employment, particularly with skilled jobs; and,
 - (c) A contribution to the achievement of wider regeneration initiatives.

The policy also states that major proposals are expected to be located on sites allocated as new employment areas or undeveloped land or vacant buildings within existing key or general employment areas but may also be appropriate on other sites subject to the provisions of Policy E4. The policy also states that smaller proposals, including premises designed for business start-ups, will be supported in closer proximity to residential areas and as part of

²³ Mansfield District Council (2020): *MDC Adopted Local Plan 2013-2033*

mixed-use schemes, subject to meeting policies relating to local amenity, pollution and land instability;

- **Policy E2 (Sites allocated as new employment areas)** outlines sites that are allocated as new employment areas;
- **Policy E3 (Retaining land for employment uses)** outlines that development proposals within the existing key or general employment areas and allocated employment areas will be supported provided that they fall within Use Class B1, B2 or B8. The policy also states that alternative uses will be supported within these areas provided they meet certain criteria; and,
- **Policy E4 (Other industrial and business development)** supports employment development outside of existing key / general employment areas and allocated employment sites subject to meeting certain criteria.
- **Policy SUE1** allocates land at Pleasley Hill Farm as a strategic sustainable urban extension including the delivery of a minimum of 1.7ha (developable area) of mixed employment uses;
- **Policy SUE2** allocates land off Jubilee Way as a strategic sustainable urban extension including the delivery of a minimum of 1.6ha (developable area) extension to Crown Farm Way Industrial Estate;
- **Policy SUE3** identifies land at Berry Hill as a committed strategic urban extension including the delivery of a minimum of 18.8ha (developable area) of mixed employment uses.

2.87 The supporting text to Policy E2 states that the employment land supply will be met from a variety of sources including completions, extant planning permissions, vacant plots within protected key and general employment areas and new employment allocations. Table 6.3 of the Plan (reproduced as Table 2.1 below) sets out the contribution from various sources.

Table 2.1 Employment Land Provision

Plan Period Employment Land Target ha	Employment Land (ha)
Target	41*
Total amount of floorspace /employment land developed between 1/4/13 and 1/4/18	2.82
Loss of employment land 2013/2019	-0.98
Sites with planning permission at 31 March 2019	23.83
Land available on key and general employment areas	8.95
Local plan allocations	17.95
TOTAL	52.57

Source: Mansfield District Local Plan 2020

* *38ha of B1c/B2 and B8 land and 3ha of employment land for B1a office space

2.88 The policies outlined above were informed by technical evidence provided in the Mansfield Employment Land Review [ELR] 2017 and Employment Land Technical Paper [ELT] 2018.

Newark and Sherwood District

2.89 Newark and Sherwood adopted the Amended Core Strategy DPD in March 2019 and this document forms a key part of the Local Development Framework [LDF] in the district. The document sets out the big issues that the council and

the public and private sector partners need to address over the next twenty years in the district. It sets a vision and objectives and a number of policies to help deliver the development and change identified.

2.90 The relevant policies relating to employment land are set out below:

- **Spatial Policy 2 (Spatial Distribution of Growth)** outlines where growth will be focused across the district. The policy also outlines the employment land requirement for Newark and Sherwood between 2013 and 2033 (this being 83.1 ha);
- **Spatial Policy 5 (Delivering the Strategy)** outlines that to ensure the employment needs of the District are delivered over the plan period, sufficient sites will be allocated to more than meet the requirements and allow for flexibility;
- **Spatial Policy 9 (Selecting Appropriate Sites for Allocation)** outlines the criteria for sites allocated for employment; and,
- **Core Policy 6 (Shaping our Employment Profile)** outlines how the economy of Newark and Sherwood District will be strengthened and broadened to provide a range of employment opportunities.

2.91 The Council also published an Allocations and Development Management DPD in 2013 with the purpose of allocating sufficient land for employment to meet the needs of Newark and Sherwood to 2026 and beyond. The Council is in the process of preparing an Updated Allocations and Development Management DPD with the intention to adopt this in 2022.

2.92 The LDF is informed by the 2015 Employment Land Forecasting Study [ELFS] (2015). Previous studies include the East Midlands Northern Sub Region ELR (2008) and the report prepared by Arup in 2010, where projected demand for additional employment land was concluded to be between 127.28 ha and 165.82 ha up until 2026.

Employment Land Needs of Adjoining Boroughs

North Kesteven and West Lindsey

2.93 North Kesteven District Council and West Lindsey District Council Officers provided a joint response to the Duty to Cooperate questions. The Council's outlined that their latest adopted position in the Central Lincolnshire Local Plan (2017) made provision for 111.1ha of land in employment use against the need figure of 23 hectares identified in the Economic Needs Assessment (2015). Allocated sites E3 (Network 46, Witham St Hugh's) and site E1 (Teal Park, North Hykeham) were stated as being relevant to the study area. In all, the Councils confirmed that they are meeting their own needs in terms of employment land, with their emerging evidence base indicating that this will continue to be the case.

South Kesteven

2.94 South Kesteven District Council Officers set out that their current employment land need is 179.2ha, with no major sites coming forward that border the

Greater Nottingham study area. The Council stated that there is a limited planning relationship with Newark & Sherwood as their main dealings are with Peterborough, Rutland and South Holland LPAs. The Council stated that their employment land needs can be met within the District. It was also stressed that study should consider the implications of the introduction of the new 'E-Class' to the planning system, the acceleration of internet shopping on how strategic distribution would be planned throughout Nottingham and any emerging evidence on the decline in demand for office floorspace as a result of the Covid-19 pandemic.

Melton

- 2.95 Melton Borough Council Officers outlined that their current employment land need is just over 20 ha, with no major sites coming forward that should be acknowledged by the study. The Council outlined that they do not have a particularly strong planning relationship with the authorities within the study area as their main dealings are with the Leicestershire authorities. However, the Council did express interest in a future discussion around sharing employment land need cross-boundary.

Charnwood

- 2.96 Charnwood Borough Council Officers set out that their current employment land need was 52.86ha over the plan period to 2037. The Council stated that there is a planning relationship with Rushcliffe given the close proximity of Loughborough (the Council's focus for employment provision) to the northern boundary; however, officers considered there to be limited connectivity to the study area in terms of employment. Sites at Garendon Development and Dishley Grange were considered relevant to the study area. In all, the Council confirmed that they have identified sufficient supply of employment land to meet their own needs in their emerging Local Plan.

North West Leicestershire

- 2.97 North West Leicestershire District Council Officers outlined that their current employment land need was 66ha according to the Leicester and Leicestershire Housing and Economic Development Needs Assessment (2017). The Council stated that multiple large employment sites were being brought forward within its jurisdiction, most notably the SEGRO East Midlands Gateway, East Midlands Distribution Centre, the proposed Aldi Distribution Centre (Coalville) and developments at Junction 1 (A50) near Castle Donnington. The Council stated that there was no history of joint working between them and the authorities within the study area and affirmed that they could currently meet their own employment needs.

South Derbyshire

- 2.98 South Derbyshire District Council Officers outlined that their current employment land need is 42.27ha for the time period between April 2011 and March 2028, with gross employment land provision within the District currently at 129.36 ha. The closest strategic employment site to the study area

is at Infinity Garden Village, a cross boundary employment development area on the southern edge of Derby City. The Council stated that there is no redistribution of employment land provision between them and the adjoining authorities within the study area. The Council confirmed that South Derbyshire does not lend itself to meeting the needs of the Nottingham HMA owing to the presence of the South East Derbyshire Green Belt.

Derby

- 2.99 Derby City Council Officers set out that their current employment land need for the Derby Urban Area is 154.5ha for the period 2008-2028. There are four strategic employment locations identified in the Local Plan: The Central Business District (the city centre), the Derwent Triangle, Derby Commercial Park and land south of Wilmore Road Sinfin. The cross-boundary employment development area at the Infinity Garden Village was also mentioned by the Council as being particularly relevant to the study area.
- 2.100 In addition to these specific strategic employment allocations, the Local Plan also identifies a number of regeneration priority sites including the former Celanese site in Spondon, on the eastern edge of the city, close to the border with Erewash. The Council stated that at present they do not know whether they are in a position to meet their own employment land needs, with this depending on the calculation of a new future needs figure. The Council stressed the potential future importance of the A52 as a potential growth corridor linking Derby to the new HS2 station at Toton and to Nottingham beyond.

Amber Valley

- 2.101 Amber Valley Borough Council Officers outlined that their current employment land need was 43.17ha (net) between 2016-2028, based on conclusions of the Employment Land Need Study undertaken on behalf of the Borough Council in 2016. A further Employment Land Review has just commenced, which will provide an updated (net) need figure to 2041. The Council stated that the development at Land at Lily Street Farm, Swanwick may be relevant to the study area although timescales for the implementation of the employment element of the development remains uncertain. In terms of cross-boundary working, the Council stated that consultation has been undertaken with neighbouring authorities as part of the preparation of respective studies of employment land need. The Council confirmed that they are not in a position to request co-operation from one or more neighbouring authorities to assist with meeting employment need.

Bolsover

- 2.102 Bolsover District Council Officers stated that their current employment land need was 92 ha (B-use classes only) between 2015 – 2033 (as identified in the Bolsover Economic Development Needs Assessment October 2015 and reflected in allocations made in the Local Plan for Bolsover District March 2020).
- 2.103 Local Plan Policy WC1: Employment Land Allocations allocates 14 sites that will deliver the remaining 72 ha of employment land needed from 2016/17 (with the difference of 20 ha already being delivered in the first years of that period). The

Wincobank Farm, South Normanton site allocation of 14 ha for B2/B8 uses is located c. 500m west of the strategic employment sites at Huthwaite Industrial Area, Ashfield. The Council stated that through the plan-making process, they have worked closely with both Ashfield District Council and Mansfield District Council as their FEMA's overlap to a degree due to the administrative geography; however, neither Council raised concerns in relation to Bolsover's employment land requirements or site allocations.

- 2.104 The Council confirmed that they have identified a sufficient supply of employment land to meet their own needs in their recently adopted Local Plan.

Local Authority Summary

- 2.105 Overall, the response to the Duty to Cooperate questions highlight that, with the exception of an expression of interest for further collaborative working from Melton Borough Council, all the adjoining authorities to the study area can meet their own employment land needs and therefore none require the Nottingham Core-Outer HMA districts to contribute towards meeting their unmet needs.

3.0 **Socio-Economic Context**

Introduction

3.1 This section sets out the economic context for the eight Nottingham Core/Outer HMA districts in the context of the Covid-19 pandemic, Brexit uncertainty and associated economic shock. The findings are based primarily upon statistical data sources but have been validated and tested in consultations with key economic development stakeholders.

3.2 The section revisits key indicators for a range of topics, including economic performance, business demography, labour market, population demographics and deprivation. The key growth drivers for Nottinghamshire and Derbyshire are also assessed in relation to the 8 districts. Comparisons are made to the rest of the East Midlands and England as a whole to provide points of reference. The section concludes with a summary of the key strengths, weaknesses, opportunities and threats [SWOT] facing the districts.

Spatial Overview

3.3 Located within the East Midlands, the Nottingham Core-Outer HMA includes a total of 8 Districts. The Core HMA consists of the City of Nottingham along with the boroughs of Gedling, Erewash, Rushcliffe and Broxtowe. The Outer HMA consists of the three districts of Ashfield, Mansfield and Newark & Sherwood.

Figure 3.1 Nottingham Core and Outer Sub-Regional Context

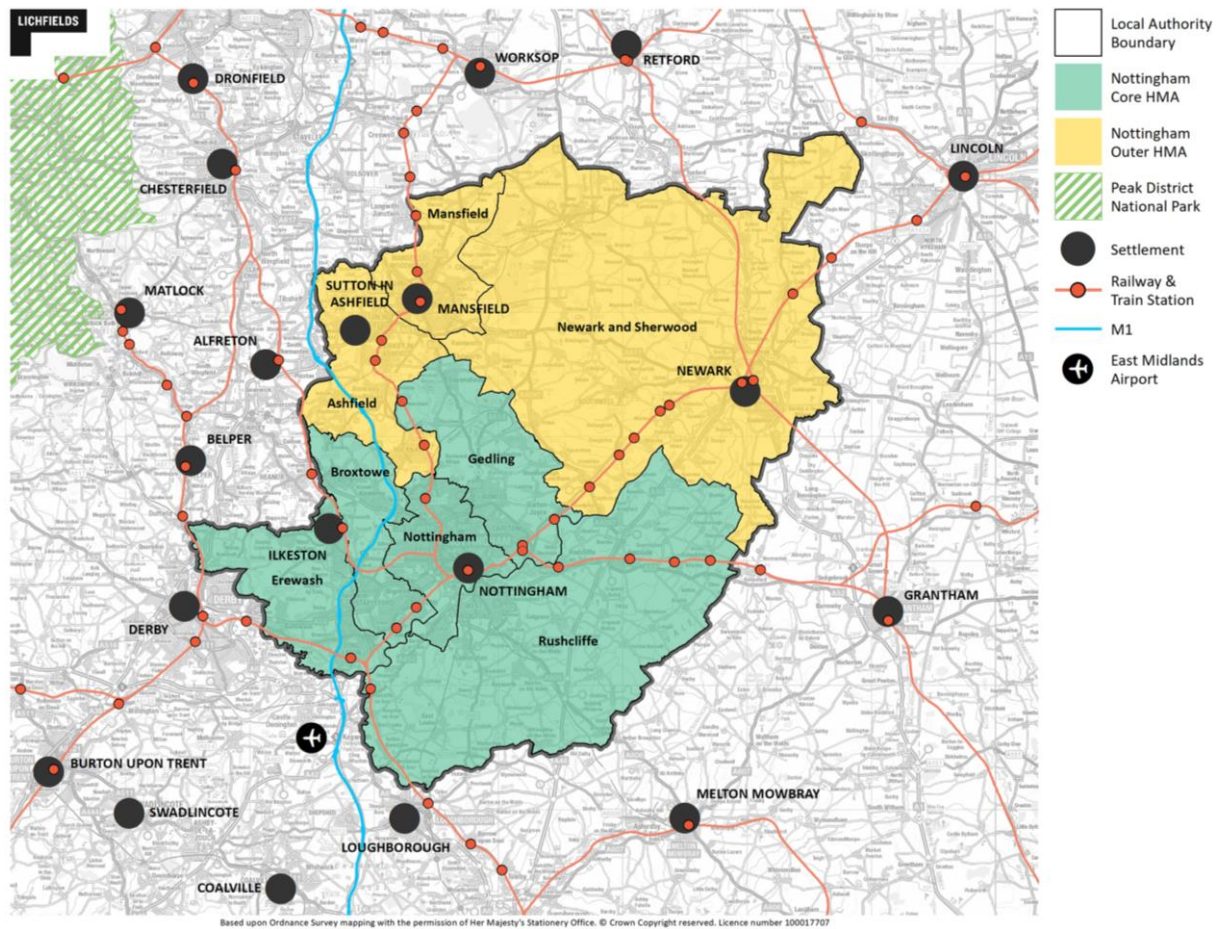

3.4

Figure 3.1 sets out the Nottingham Core/Outer HMA’s spatial context relative to adjoining authorities, settlements and key sub-regional transport infrastructure, including:

- The M1 – a key strategic route connecting Yorkshire to the north and East Midlands and London to the south.
- East Midlands Airport – provides national and international connections for business and leisure visitors. The airport is also a major hub for freight operations throughout Europe.
- East Midland Railway Network – provides national passengers regular connections across the country along the Midland Main Line. Separate rail networks also cross the study area east to west providing access to Birmingham and South Wales, Lincoln, Peterborough, Norwich, Manchester and Liverpool. Northern Rail operates direct services to/from Leeds and Nottingham whilst the East Coast Main Line runs along the eastern side of the study area with a station at Newark Northgate; this provides direct linkages to London Kings Cross, Yorkshire, the North East and Scotland.

Economic Conditions and Trends

Macro-Economic Trends

- 3.5 Macro-economic trends are a critical influence on the future performance of the Core-Outer HMAs' economy. These shape the level of demand for the sale of goods and services. In turn this affects business formation and survival, investment decisions, recruitment, wages and productivity.
- 3.6 The outbreak of Covid-19 and resulting pandemic has developed rapidly with far reaching impacts on the economy and business across the country. Lockdown measures have led to unprecedented shutdowns of large parts of the economy simultaneously, with effects being transmitted rapidly across all sectors.

Figure 3.2 GDP Monthly index, January 2007 to November 2020

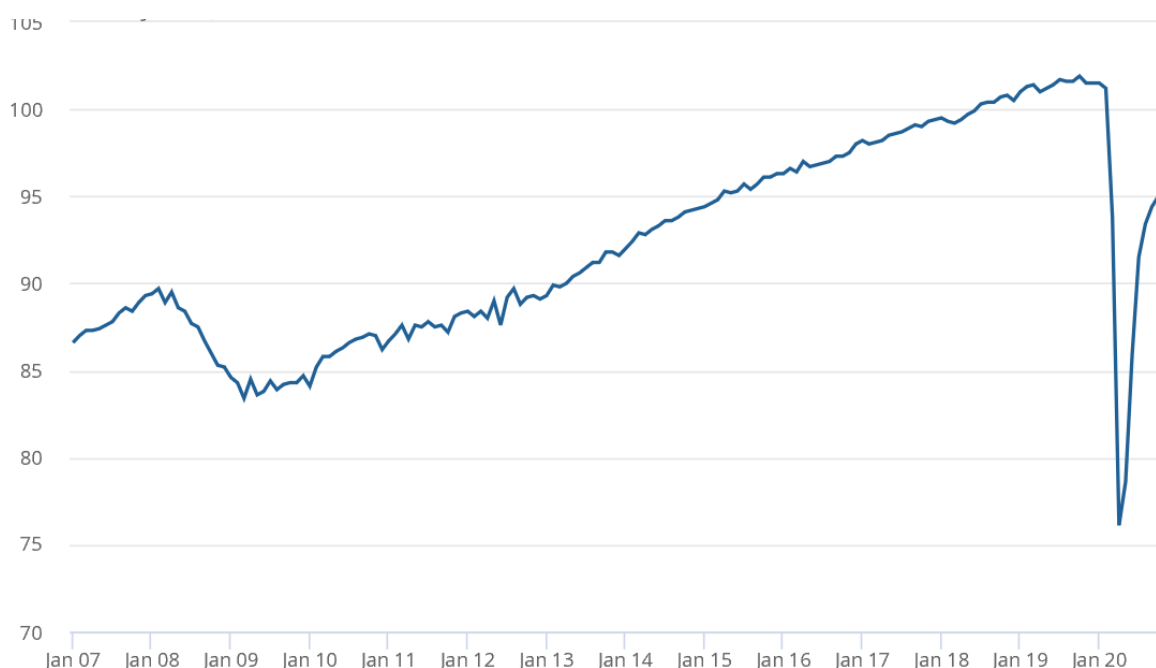

Source: ONS GDP Monthly Estimates, November 2020

- 3.7 The latest official figures from the Office for National Statistics [ONS] show that UK Gross Domestic Product [GDP] fell by 20.4% in Q2 2020, meaning the UK entered a technical recession. This is the largest fall since monthly records began in 1997, reflecting record widespread falls in services, production and construction output as the negative impacts of social distancing and lockdown kicked in (Figure 3.2). Following six consecutive monthly increases, including an upwardly revised 0.6% increase in October, real gross domestic product (GDP) fell by 2.6% in November 2020. November GDP fell back to 8.5% below the levels seen in February 2020 compared with 6.1% below in October 2020. GDP fell by 8.9% in the 12 months to November 2020, compared with an annual decline of 6.8% to October.
- 3.8 The services sector acted as the main drag on growth in November, falling by 3.4% as restrictions on activity were reintroduced in some parts of the UK in

response to the coronavirus (COVID-19) pandemic. The services sector is now 9.9% below the level of February 2020 (Figure 3.3).

3.9 The production sector also fell marginally by 0.1% in November 2020, remaining 4.7% below the February 2020 level. Elsewhere the construction sector saw positive growth of 1.9% in November 2020, recovering to 0.6% above the February 2020 level

3.10 Looking ahead, results from Wave 21 of the Business Impact of Coronavirus (COVID-19) Survey (BICS), which covered the dates 14 to 27 December 2020, found that of businesses currently trading, 42% reported their turnover had decreased below what is normally expected for December, compared with 45% reporting decreases at the end of November in Wave 19. The accommodation and food service activities industry and the arts, entertainment and recreation industry had the highest percentages of businesses experiencing a decrease in turnover compared with normal expectations for this time of year, both at 76%.

Figure 3.3 Monthly index, January 2020 to November 2020, January 2020 = 100

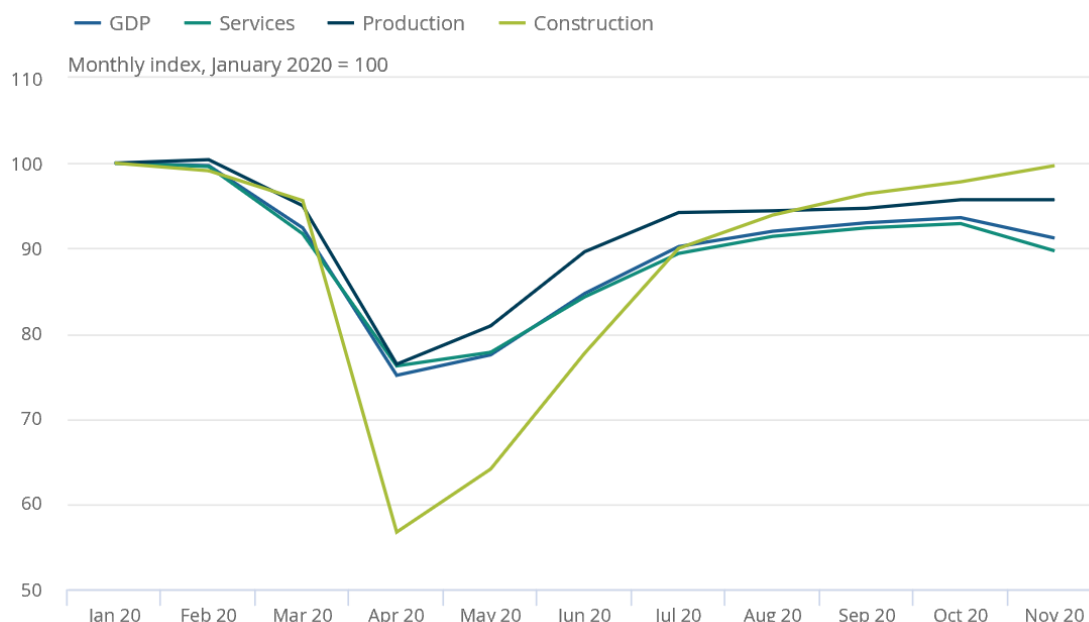

Source: ONS (2020) GDP Monthly Estimates

3.11 Furthermore, the Office for Budget Responsibility [OBR] published its November 2020 Economic and fiscal outlook²⁴. This report indicated that the economic outlook remains highly uncertain and depends upon the future path of the virus, the stringency of public health restrictions, the timing and effectiveness of vaccines, and the reactions of households and businesses to all of these.

3.12 That said, the OBR presented three scenarios for the virus (Figure 3.4); an upside scenario, in which lockdown succeeds in bringing the second wave of infections under control and the rapid rollout of effective vaccines enables output to return to its pre-virus level late next year; a central one, in which restrictive public health measures need to be kept in place until the spring and

²⁴ OBR (2020): *November 2020 Economic and fiscal outlook*

vaccines are rolled out more slowly, leading to a slower return to pre-virus levels of activity at the end of 2022; and a downside one, in which lockdown has to be extended, vaccines prove ineffective in keeping the virus in check, and a more substantial and lasting economic adjustment is required with economic activity only recovering to its pre-virus level at the end of 2024.

3.13

It also outlined that the combined impact of the virus on the economy and the Government's fiscal policy response pushes the deficit this year to £394 billion (19 per cent of GDP), its highest level since 1944-45, and debt to 105 per cent of GDP, its highest level since 1959-60.

Figure 3.4 Real GDP: central forecast and alternative scenarios

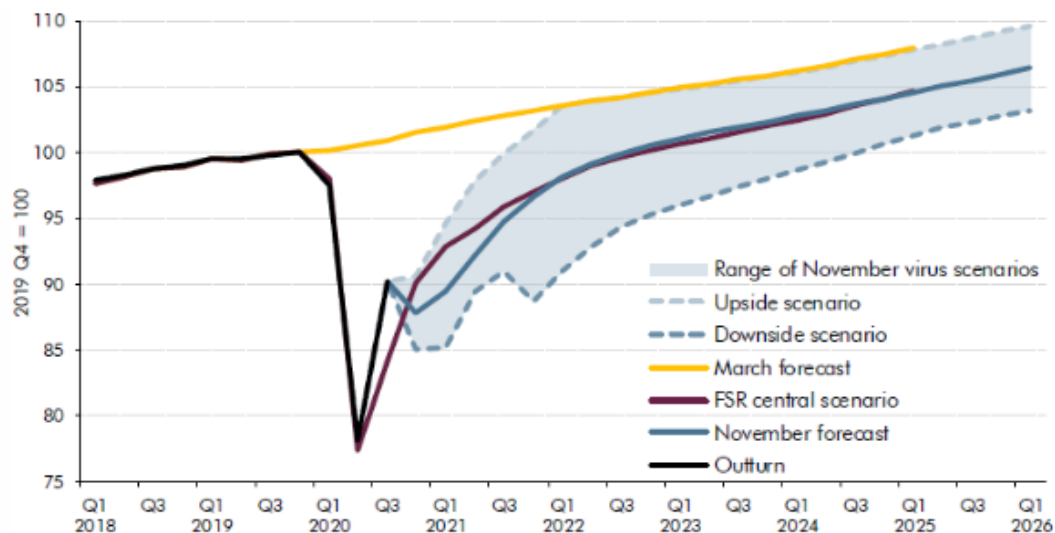

Source: ONS, OBR (2020)

3.14

The most recent macro-economic forecasts were released by Experian at the end of September 2020. These projections reflect the '**Delayed-V-shape**' **scenario**, which is Experian's base case. Given the uncertainty surrounding the pandemic and its impact on the economy they have produced a number of scenarios which help illustrate the different channels of impact. According to Experian's Data Guide²⁵, the latest national accounts data confirm that, since lockdown began in March, the economy has suffered an unprecedented contraction, with a record fall of 20.4% on the quarter, in 2020Q2. Early experimental estimates suggest the unemployment rate to have risen close to 5% at the end of July. Over 9 million employees have been furloughed, with close to 3 million of those self-employed receiving income support. The gradual reopening of businesses as well as government measures to stimulate the hospitality sector has seen growth return in the summer months, though new government measures aimed at suppressing the virus (curfews, increased fines) could see growth become muted.

3.15

These base case 'delayed V-shaped' recovery scenario implies an overall GDP reduction of 11.7% for 2020, following the sharp decline recorded in April as lockdown measures and social distancing stifled consumer spending (Table 3.1) followed by a delayed recovery of 3.2% 2021-2027.

²⁵ Experian (September 2020): Data Guide: UK Regional Planning Service

Table 3.1 Experian: September 2020 RPS Forecast vs. Previous Forecast (May 2020 Macro = June 2020 RPS) in brackets

UK	2017	2018	2019	2020	2021-2027	2028-2040
GDP growth	1.9% (1.9%)	1.3% (1.3%)	1.5% (1.4%)	-11.7% (-15.4%)	3.2% (3.9%)	1.7% (1.7%)
Workforce Jobs growth	1.0% (1%)	0.6% (0.6%)	1.7% (1.7%)	-2.4% (-3.7%)	0.9% (1.1%)	0.5% (0.5%)
Unemployment rate	4.4% (4.4%)	4.1% (4.1%)	3.8% (3.8%)	6.9% (8.3%)	5.3% (5.3%)	4.0% (4.1%)
Real Income growth	1.4% (1.4%)	2.5% (2.5%)	1.3% (1.3%)	-3.2% (-5.3%)	1.9% (2.7%)	1.9% (1.9%)
Spending Volumes growth	2.2% (2.2%)	1.6% (1.6%)	1.0% (1.1%)	-13.0% (-16.3%)	3.1% (4%)	1.8% (1.8%)
House price growth	4.5% (4.5%)	3.2% (3.2%)	1.2% (1.2%)	-2.6% (-3.4%)	3.8% (4%)	4.0% (4%)

Source: Experian UK Macro Economic Forecast September 2020

3.16

Returning to the OBR, the November outlook report stated that the virus has exacted a heavy toll on public finances²⁶. In the central forecast, receipts this year are set to be £57 billion lower, and spending £281 billion higher, than last year. The Government has committed huge sums to treat the infected, control the spread of the virus, and cushion its financial impact on households and businesses. As support has been expanded and extended, including in the wake of the second wave of infections, its total cost this year has risen from £181 billion at the time of the Summer Economic Update, to £218 billion at the time of the Winter Economy Plan, to £280 billion in this forecast.

Figure 3.5 Public sector net borrowing: central forecast and scenarios

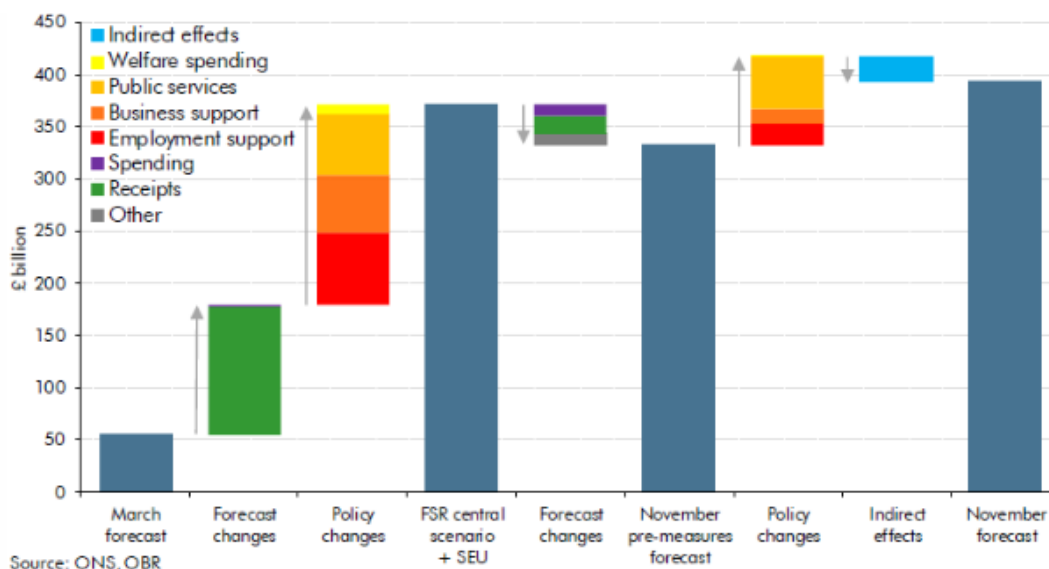

Source: ONS, OBR (2020)

3.17

As mentioned, the central forecast outlines that the combined impact on the economy and the Government’s fiscal policy response pushes the deficit this year to £394 billion, and debt to 105% of GDP (Figure 3.5). Borrowing falls

²⁶ OBR (2020): *November 2020 Economic and fiscal outlook*

back to around £102 billion (3.9% of GDP) by 2025-26, but even on the loosest conventional definition of balancing the books, a fiscal adjustment of £27 billion (1% of GDP) would be required to match day-to-day spending to receipts by the end of the five-year forecast period.

- 3.18 According to ONS²⁷, public sector net borrowing (excluding public sector banks, PSNB ex) is estimated to have been £31.6 billion in November 2020, £26.0 billion more than in November 2019, which is both the highest November borrowing and the third-highest borrowing in any month since monthly records began in 1993.
- 3.19 Indeed, public sector net borrowing (PSNB ex) in the first eight months of this financial year (April to November 2020) is estimated to have been £240.9 billion, £188.6 billion more than in the same period last year and the highest public sector borrowing in any April to November period since records began in 1993.²⁸
- 3.20 Public sector net debt excluding public sector banks (PSND ex) rose by £301.6 billion in the first eight months of the financial year to reach £2,099.8 billion at the end of November 2020, or around 99.5% of GDP; this was the highest debt to GDP ratio since the financial year ending 1962.
- 3.21 The current attention on the impacts of the Coronavirus has somewhat over-ridden pre-existing risks to global growth that could arise from an escalation of trade tensions beyond those already incorporated in the aforementioned growth forecast. A range of triggers beyond escalating trade tensions could spark a further deterioration in risk sentiment with adverse growth implications, especially given the high levels of public and private debt.
- 3.22 The main shared policy priority is for countries to resolve co-operatively and quickly their trade disagreements and reverse the resulting policy uncertainty, rather than raising harmful barriers further and destabilizing an already slowing global economy. Across all economies, measures to boost potential output growth, enhance inclusiveness, and strengthen fiscal and financial buffers in an environment of high debt burdens and tighter financial conditions are imperatives.
- 3.23 This has of course overshadowed the Chancellor's budget announcements regarding investments in infrastructure, technology, housing, skills, and clean growth. The underlying narrative was positioning the UK to capitalise on post-EU exit opportunities; however future spending decisions will depend on Brexit and the extent of the Post-Covid recovery. In October 2019, the Chancellor claimed that austerity was over, yet it remains to be seen how this will be balanced against the unprecedented borrowing levels and likely deep recession. Clearly the considerable economic uncertainty over Brexit and the pandemic are ongoing (at the time of writing) and future growth projections are very much subject to change depending on the nature of the post-Covid 19 recovery and the ease with which the economy adjusts to the UK's exit from the EU.

²⁷ ONS (2020): *Public sector finances, UK: November 2020*

²⁸ Ibid

UK Industrial Sector Growth Prospects

3.24 In terms of future growth prospects, clearly the uncertainty surrounding the Pandemic and Brexit looms large over any attempt to project where the UK and Nottingham Core-Outer HMA in particular may be heading. Research by Experian suggests that Brexit may have a particular impact on industrial sectors that are most exposed, such as chemicals and transport equipment, whilst having less of an impact on sectors such as public administration & defence, utilities and agriculture.

3.25 Similarly, although no part of the economy is immune from the effects of the pandemic, so far the impact on individual sectors has varied reflecting the extent to which lockdown measures have forced some industries to temporarily ‘shut down’.

Figure 3.6 Week by Week 2017-2020 Volume of e-Commerce Start-Ups

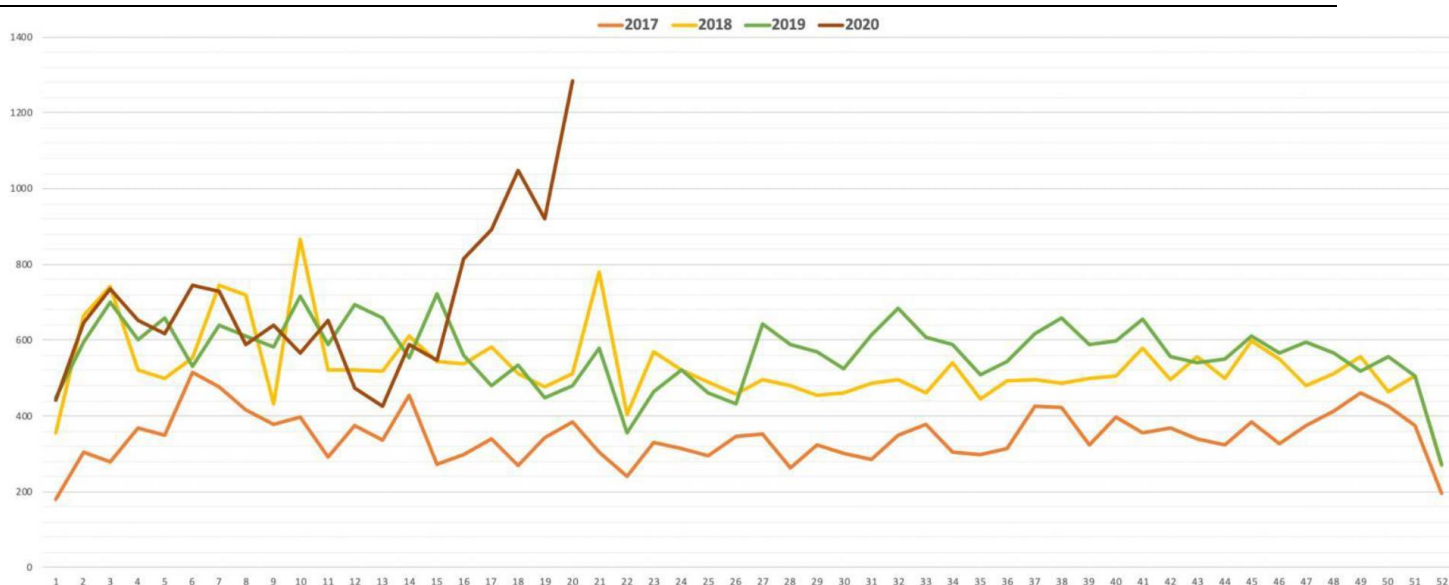

Source: Business Data Group (2020)

3.26 Some sectors have seen their output directly impacted by the lock-down (such as entertainment and recreation) while others have continued to function at some level through remote-working (such as professional services), albeit potentially with reduced capacity. For example, there is clear evidence that there has been a significant shift to e-commerce, with the volume of new eCommerce start-ups increasing significantly since the first lockdown in March 2020 (Figure 3.6).

3.27 The services sector acted as the main drag on growth in November, falling by 3.4% as restrictions on activity were reintroduced in some parts of the UK in response to the coronavirus (COVID-19) pandemic. The services sector is now 9.9% below the level of February 2020 (Figure 3.7) There were falls in output in all 14 services sub-sectors between October and November 2020. The largest contributor to this fall was accommodation and food service activities, followed by wholesale and retail trade, other service activities and arts, entertainment

and recreation, because of the reintroduction of restrictions in some parts of the UK. These four sectors accounted for nearly 80% of the fall in services.

Figure 3.7 Services sector Monthly index, February 2020 to November 2020, February 2020 = 100

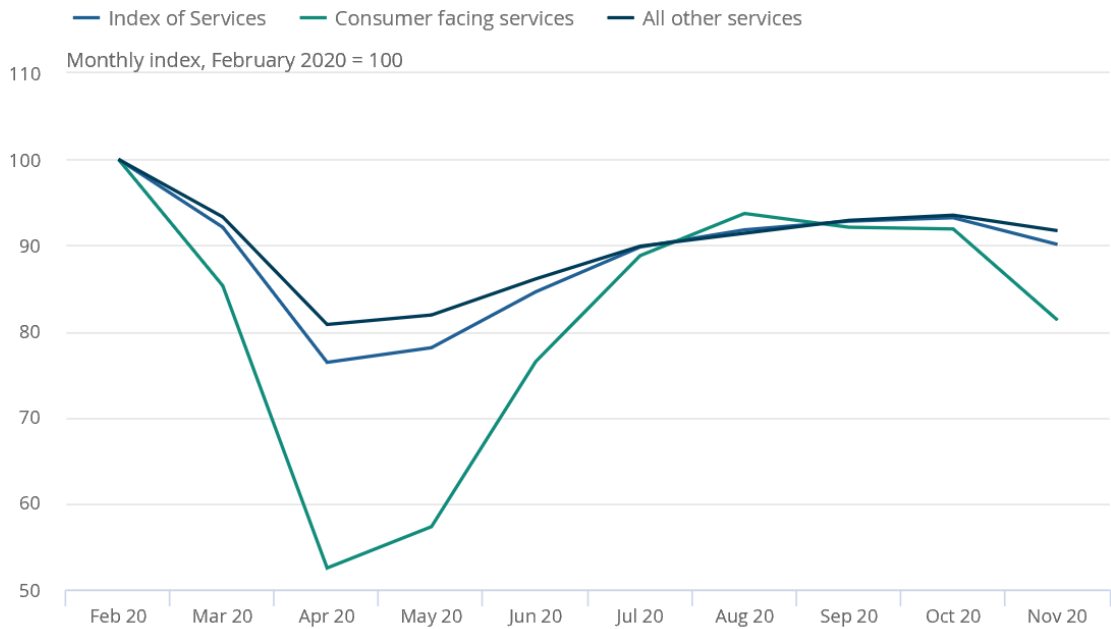

Source: ONS (2020) GDP Monthly Estimate

3.28

According to the ONS, production fell marginally by 0.1% in November 2020 as three out of the four sub-sectors fell. Mining and quarrying fell by 3.4% due to reduced demand in the global market. This was the fifth consecutive monthly fall, driven by a fall of 4.5% from oil and gas extraction. The manufacturing sector grew by 0.7%, with 8 out of its 13 sub-sectors increasing. The largest contribution came from the manufacture of motor vehicles industry, which grew 5.7% in November 2020. This is a result of growth from large businesses to meet increased demand, and this industry is now 1.3% above its February 2020 level.

Figure 3.8 Production sector monthly index, February 2020 to October 2020, February 2020 = 100

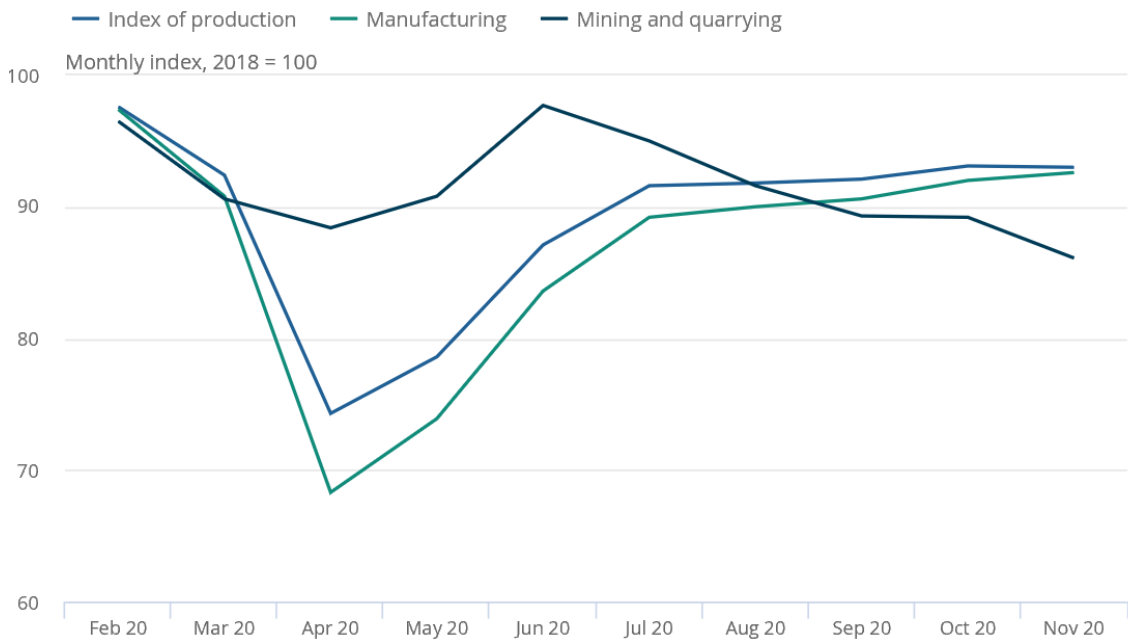

Source: ONS (2020) GDP monthly estimate

3.29

Some sectors have the potential to rebound quickly as lock-down measures are eased, with construction being an obvious example. Output in construction grew by 1.9% in November 2020, the seventh consecutive month of growth, suggesting this sub-sector was largely unaffected by the reintroduction of new restrictions (Figure 3.9).

Figure 3.9 Construction Output Monthly index, January 2018 to October 2020, 2018 = 100

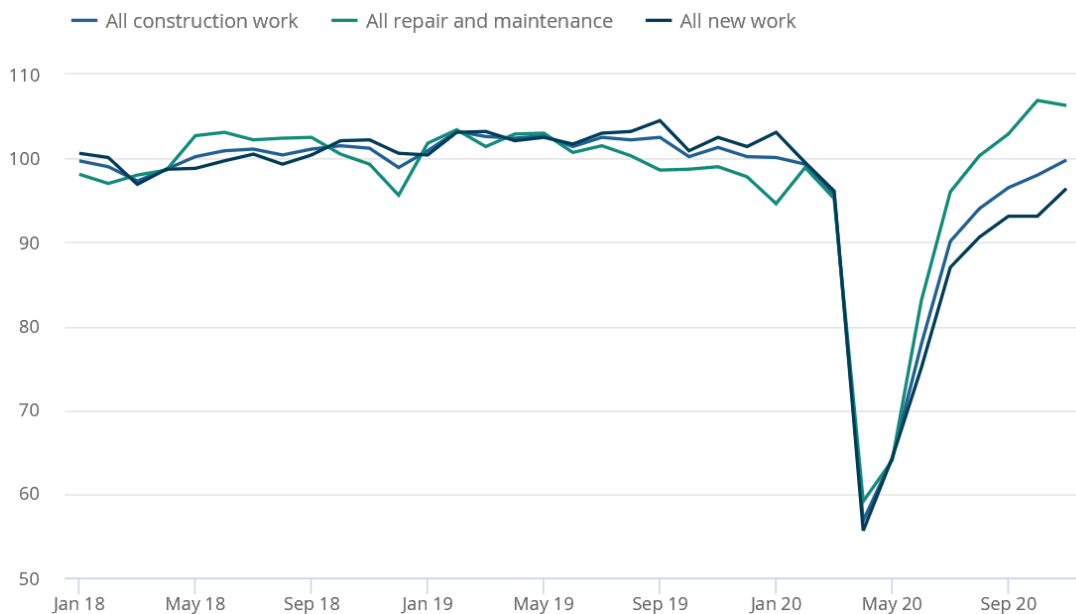

Source: ONS (2020) GDP monthly estimate and Construction output in Great Britain

3.30

However, there may well be longer-lasting effects. For instance, consumption-led activities such as retail may be vulnerable if consumer confidence continues to fall and spending remains cautious.

Economic Performance

Future Job Growth Prospects

3.31 Though viewed as a temporary shock, the latest Experian Covid-19 adjusted job forecasts for the Nottingham Core-Outer HMA (September 2020) imply a significant impact on almost all sectors of the economy and all parts of the region. As noted above, the forecasts are based on the assumption that the recovery will follow a delayed-V shape, with a substantial drop in output in Q2 2020 as economic activity was highly restricted due to lockdown measures to contain the virus. The virus in the UK is assumed (by Experian) to be brought under control after five months of intensive suppression, with the economy bouncing back in the second half of the year. This has not factored in the subsequent lockdowns and particularly the very significant nationwide lockdown in early 2021 which seems almost certain to further delay any recovery into late in 2021.

Figure 3.10 Experian: Nottingham Core HMA Workforce Jobs

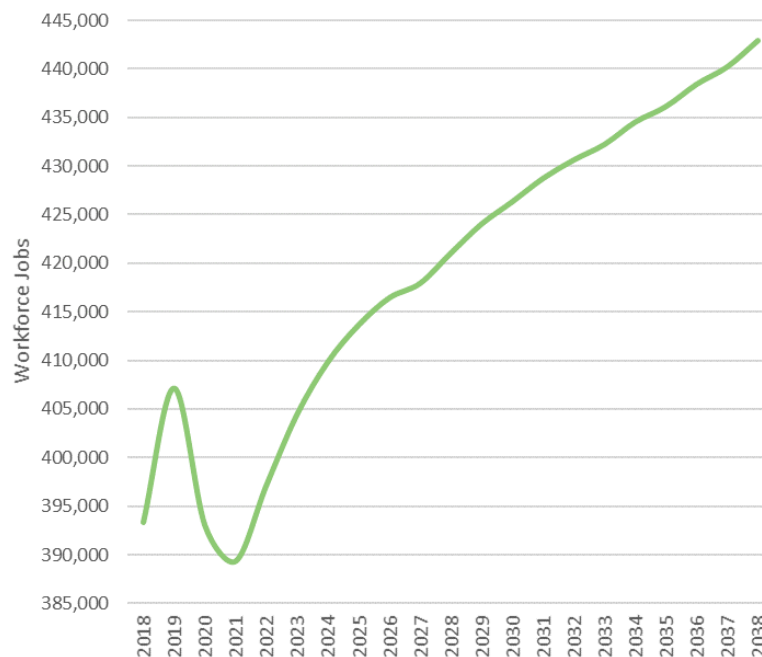

Source: Experian UK Local Market Forecasts Quarterly September 2020

3.32 Experian forecasts a fall of 14,100 jobs this year, or 3.5% of the Nottingham Core HMA workforce, with a further fall of 3,700 jobs (0.9%) in 2021, before a protracted recovery that will see a return to pre-Covid levels by 2024 (Figure 3.10). This is a more protracted return to 2019 workforce jobs than is projected for the UK as a whole by Experian (a -2.4% adjustment 2019-20, followed by a recovery by 2023).

Figure 3.10 Experian: Nottingham Outer HMA Workforce Jobs

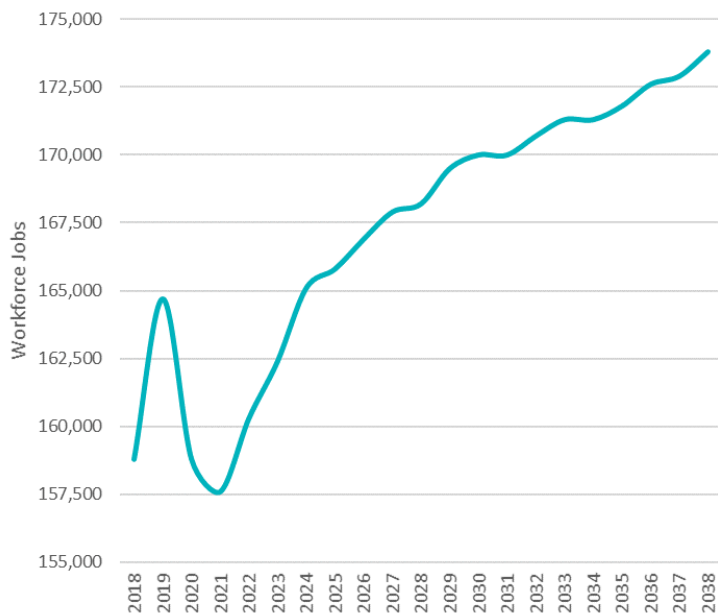

Source: Experience UK Local Market Forecasts Quarterly September 2020

- 3.33 Regarding the Nottingham Outer HMA, Experian forecasts a fall of 5,900 jobs this year, or 3.6% of the total workforce, with a further fall of 1,200 jobs (0.7%) in 2021, before a protracted recovery that will see a return to pre-Covid levels by 2024 (Figure 3.11). Again, this is a more protracted return to 2019 workforce jobs than is projected for the UK as a whole by Experian.
- 3.34 Over the longer term, net job growth between 2018 and 2038 is anticipated to be in the order of 49,600 in the Core HMA and 15,000 in the Outer HMA, with much of this growth occurring in the first few years after the Pandemic. This equates to a Compound Annual Growth Rate [CAGR] of 0.596% for the Core HMA and 0.452% for the Outer HMA.
- 3.35 The Nottingham Core HMA’s future job growth prospects are not too dissimilar to the historic job growth experienced since 1998 where an additional 37,500 jobs were created (net) to 2018, boosting the size of the local workforce by 10.5% and a CAGR of 0.502% - a growth rate substantially lower than the East Midlands and the UK as a whole.
- 3.36 Going forward, the 0.596% CAGR growth rate for the Core HMA is above the comparator areas, and 9% higher than the annual growth rate projected for the rest of the UK (Table 3.2). On the other hand, the Nottingham Outer HMA’s moderate job growth prospects stand in contrast to the very strong job growth experienced since 1998 where an additional 35,000 jobs were created (net) to 2018, boosting the size of the local workforce by 22.0% and a CAGR of 1.253% - a growth rate higher than the East Midlands and the UK as a whole.
- 3.37 However, going forward, the 0.452% CAGR growth rate for the Outer HMA is below the comparator areas and 17% lower than the annual growth rate projected for the UK as a whole (Table 3.2).

Table 3.2 Historic and Projected Employment Change

	1998 to 2018		2018 to 2038	
	Net Workforce Jobs Growth	CAGR	Net Workforce Jobs Growth	CAGR
Nottingham Core HMA	37,500	0.502%	49,600	0.596%
Nottingham Outer HMA	35,000	1.253%	15,000	0.452%
East Midlands	337,050	0.774%	242,620	0.490%
UK	6,031,780	0.947%	4,022,070	0.544%

Source: Experian (September 2020) UK Local Market Forecasts Quarterly - Workforce Jobs: Lichfields analysis.

3-38

Table 3.3 shows the projected change in sector employment in Nottingham Core HMA over the period 2018 to 2038. The Professional & Other Private Services sector, which plays the largest role in the HMAs economy in terms of the number of jobs, is projected to grow by 13.64%; with a job increase of 12,100. The largest growth sector is likely to be in Health, Residential Care & Social Work, which is forecast by Experian to increase by 19,100 jobs, a growth of over a third on 2018 levels. The Information & Communication Sector is equally projected to grow by over a third in 20 years' time with jobs increasing by 5,900. Other significant growth sectors include Construction (+3,300 jobs) and Education (+6,700 jobs). The biggest decrease is forecast in the Manufacturing sector with a reduction of 5,300 jobs over the 20-year period.

Table 3.3 Projected Sectoral Employment Change in Nottingham Core HMA 2018-38

	2018		2038		Change from 2018 to 2038	
	Jobs	CAGR	Jobs	CAGR	Jobs	CAGR
Accommodation, Food & Recreation	38,300	9.74%	42,100	9.51%	3,800	9.92%
Agriculture, Forestry, Fishing & Mining	1,000	0.25%	1,000	0.23%	0	0%
Construction	21,900	5.57%	25,200	5.69%	3,300	15.07%
Education	40,100	10.20%	46,800	10.57%	6,700	16.71%
Finance & Insurance	7,200	1.83%	7,900	1.78%	700	9.72%
Health, Residential Care & Social Work	53,500	13.60%	72,600	16.39%	19,100	35.70%
Information & communication	16,500	4.20%	22,400	5.06%	5,900	35.76%
Manufacturing	25,400	6.46%	20,100	4.54%	-5,300	-20.87%
Professional & Other Private Services	88,700	22.55%	100,800	22.76%	12,100	13.64%
Public Services	18,500	4.70%	18,200	4.11%	-300	-1.62%
Transport & storage	13,700	3.48%	15,700	3.54%	2,000	14.60%
Utilities	6,700	1.70%	6,500	1.47%	-200	-2.99%
Wholesale & Retail	61,800	15.71%	63,600	14.36%	1,800	2.91%
All Sectors	393,300	100%	442,900	100.0%	49,600	12.61%

Source: Experian (September 2020) UK Local Market Forecasts Quarterly - Workforce Jobs: Lichfields analysis.

3-39

Table 3.4 shows the projected change in sector employment in Nottingham Outer HMA over the period 2018 to 2038. The Profession and Other Private Services Sector, which plays the largest role in the local economy in terms of the number of jobs, is projected to grow slightly by 8.42%. The largest growth sector is likely to be in Information & Communication, which is forecast by Experian to increase by 1,700 jobs, a growth of 44.74% on 2018 levels. The next largest growth sector is Health, Residential Care and Social Work, which is projected to increase by a third or 8,100 jobs by 2038. Other significant growth sectors include Construction (+2,300 jobs) and Accommodation, Recreation & Food (+2,400 jobs). The biggest decreases are forecast in the Manufacturing sectors with a loss of 4,700 jobs, and Utilities (-300 jobs).

Table 3.4 Projected Sectoral Employment Change in Nottingham Outer HMA 2018-2038

	2018		2038		Change from 2018 to 2038	
	Employment	%	Employment	%	Change	%
Accommodation, Food & Recreation	17,900	11.27%	20,300	11.68%	2,400	13.41%
Agriculture, Forestry, Fishing & Mining	1,400	0.88%	1,300	0.75%	-100	-7.14%
Construction	11,300	7.12%	13,600	7.83%	2,300	20.35%
Education	11,200	7.05%	12,800	7.36%	1,600	14.29%
Finance & Insurance	1,300	0.82%	1,300	0.75%	0	0.00%
Health, Residential Care & Social Work	24,300	15.30%	32,400	18.64%	8,100	33.33%
Information & communication	3,800	2.39%	5,500	3.16%	1,700	44.74%
Manufacturing	18,000	11.34%	13,300	7.65%	-4,700	-26.11%
Professional & Other Private Services	29,700	18.70%	32,200	18.53%	2,500	8.42%
Public Services	5,000	3.15%	5,300	3.05%	300	6.00%
Transport & storage	6,600	4.16%	7,100	4.09%	500	7.58%
Utilities	2,300	1.45%	2,000	1.15%	-300	-13.04%
Wholesale & Retail	26,000	16.37%	26,700	15.36%	700	2.69%
All Sectors	15,880	100%	17,3800	100.0%	15,000	9.45%

Source: Experian (September 2020) UK Local Market Forecasts Quarterly - Workforce Jobs. Lichfields Analysis

Business Demography

3.40

The Nottingham Core-Outer HMA has around 35,955 business enterprises, and, as is common across the East Midlands and the UK in general, the vast majority of these are classified as Small and Medium Enterprises [SMEs] with up to 249 employees²⁹. Table 3.5 summarises the business stock in the Nottingham Core-Outer HMA and compares it to the East Midlands and the UK.

Table 3.5 Size of Enterprises (2019)

	Nottingham Core HMA		Nottingham Outer HMA		East Midlands	UK
Total	25,240	100.00%	10,715	100.00%	100.00%	100.00%
Micro (0 to 9)	22,330	88.47%	9,430	88.01%	89.10%	89.55%
Small (10 to 49)	2,330	9.23%	1,045	9.75%	8.89%	8.52%
Medium (50 to 249)	430	1.70%	195	1.82%	1.62%	1.54%
Large (250+)	145	0.57%	45	0.42%	0.39%	0.39%

Source: ONS (2020) Business Counts / Lichfields Analysis

3.41

From 2013 to 2016 the stock of businesses in Nottingham Core HMA increased year on year³⁰. This was caused by a greater number of business births than business deaths, resulting in a net increase in these years. This was particularly notable in 2015, where there was a net growth of 1,150 businesses. The years 2017 and 2018 (the most recent year for which data has been made available by ONS) tell a different story however, with 470 and 195 more business failures than successes in 2017 and 2018 respectively. Figure 3.11 illustrates the number of business births and deaths in the Nottingham Core HMA between 2013 and 2018.

²⁹ ONS (2020): UK Business Counts

³⁰ ONS (2018) Business Demography – 2017: Enterprise Births, Deaths and Survivals

Figure 3.11 Business Births and Deaths in the Nottingham Core HMA (2013-2018)

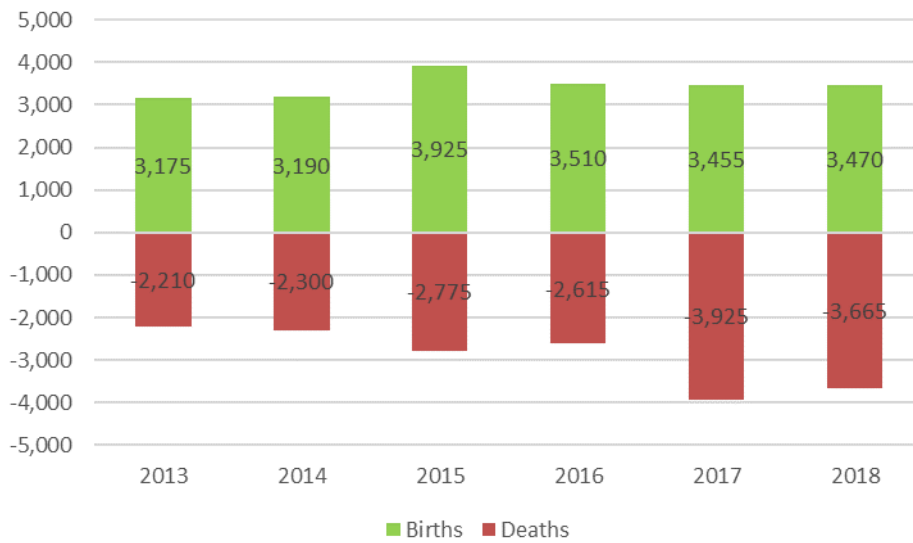

Source: ONS (2020) Business Demography - 2018: Enterprise Births, Deaths and Survivals

3.42

The Nottingham Outer HMA has seen more positive results in terms of its stock of businesses, with increases year on year through 2013 to 2018. This was particularly notable in 2016, where there was a net growth of 425 businesses. 2018 however experienced a slowing of growth, with the lowest net figure of 200 new businesses and this trend is expected to continue with the impacts of the pandemic and Brexit not yet fully known. Figure 3.12 illustrates the number of business births and deaths in the Nottingham Core HMA between 2013 and 2018.

Figure 3.12 Business Births and Deaths in the Nottingham Outer HMA (2013-2018)

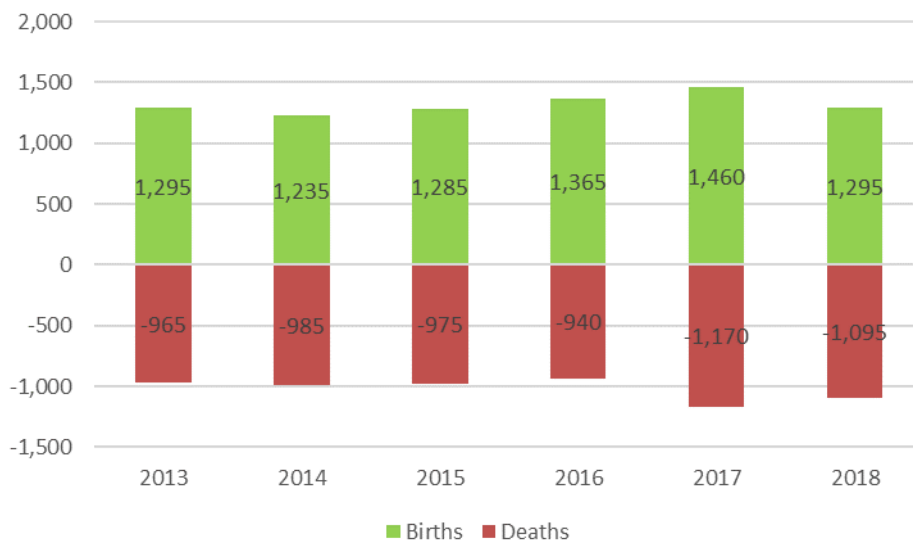

Source: ONS (2020) Business Demography - 2018: Enterprise Births, Deaths and Survivals

3.43

Between 2013 and 2018, Nottingham Core HMA business stock grew at a stronger rate (22.0%) than either the East Midlands (17.3%) or the UK (20.1%)

as a whole, whilst businesses in the Outer HMA grew at a weaker rate (13.3%). The number of active enterprises based in the Core HMA increased by 5,130 over that period, which accounted for 18% of the East Midlands total net gain (Table 3.6). The number of active enterprises based in the Outer HMA increased by 1,315 over that period, under 5% of the East Midlands total net gain.

Table 3.6 Annual Change in Active Enterprises

	2013 to 2014	2014 to 2015	2015 to 2016	2016 to 2017	2017 to 2018	2013-2018
Nottingham Core HMA	880	1,570	1,390	1,680	-390	5,130
	3.8%	6.5%	5.4%	6.2%	-1.4%	22.0%
Nottingham Outer HMA	220	225	500	430	-60	1,315
	2.2%	2.2%	4.9%	4.0%	-0.5%	13.3%
East Midlands	6,255	8,860	7,150	6,720	-1,170	27,815
	3.9%	5.3%	4.1%	3.7%	-0.6%	17.3%
UK	102,065	121,105	161,810	92,090	13,920	490,990
	4.2%	4.8%	6.1%	3.3%	0.5%	20.1%

Source: ONS (2020) Business Demography - 2018: Enterprise Births, Deaths and Survivals

- 3.44 As shown in Table 3.7, businesses that locate in the Nottingham Core-Outer HMA tend to have slightly higher survival rates than might be expected elsewhere. Of the 4,425 business births in 2014, 2,225, or 50.3%, were still around 4 years later, compared to 48.9% regionally and 49.3% across the UK as a whole.

Table 3.7 Births of units in 2014 and their survival

	Births	1-year survival	1-year percent	2-year survival	2-year percent	3-year survival	3-year percent	4-year survival	4-year percent
Nottingham Core HMA	3,190	2,990	93.7%	2,435	76.3%	1,980	62.1%	1,610	50.5%
Nottingham Outer HMA	1,235	1,155	93.5%	935	75.7%	765	61.9%	615	49.8%
East Midlands	22,035	20,565	93.3%	16,770	76.1%	13,570	61.6%	10,765	48.9%
UK	350,305	323,105	92.2%	265,535	75.8%	214,460	61.2%	172,720	49.3%

Source: ONS (2020) Business Demography - 2018: Enterprise Births, Deaths and Survivals

- 3.45 Table 3.8 indicates the Nottingham Core-Outer HMA business composition when compared to the rest of the East Midlands and the UK.
- 3.46 Generally, the Nottingham Core HMA indicates a similar business composition when compared to the comparators. However, the health sector (4.9%) is over-represented when compared to the rest of the region (3.7%) and the UK (3.7%). Conversely, the agricultural, forestry & fishing sector is significantly under-represented (1.94%) when set against the comparators which is to be expected due to urban and sub-urban nature of the districts within the Core HMA.
- 3.47 The Nottingham Outer HMA has a slightly different picture with many disparities to the comparator areas. These are particularly seen in the manufacturing and construction sectors, which combine to represent nearly a quarter of the Outer HMA's businesses; with the manufacturing sector representing 7.51% of businesses and the construction sector 16.4%. This is significantly higher than the East Midlands rate, where manufacturing is 6.62% and construction 13% of all businesses; and the UK, where manufacturing is 5%

and construction 12.8%. Alternatively, the professional, scientific and technical sector (12.5%) is under-represented when compared to both the region (13.8%) and the UK (17%). There are also regional disparities in the transport and storage sector and national disparities in the information & communication sector, where the Outer HMA is significantly under-represented.

Table 3.8 UK Business Counts - enterprises by industry (2020)

Industrial Sector	Nottingham Core HMA		Nottingham Outer HMA		East Midlands	UK
Agriculture, forestry & fishing	490	1.94%	545	5.09%	6.00%	5.41%
Mining, quarrying & utilities	130	0.52%	85	0.79%	0.51%	0.54%
Manufacturing	1,615	6.40%	805	7.51%	6.62%	5.01%
Construction	3,460	13.71%	1,755	16.38%	12.99%	12.77%
Motor trades	850	3.37%	485	4.53%	3.65%	2.80%
Wholesale	970	3.84%	470	4.39%	4.09%	3.69%
Retail	2,085	8.26%	900	8.40%	7.43%	7.59%
Transport & storage	1,005	3.98%	570	5.32%	6.96%	4.48%
Accommodation & food services	1,485	5.88%	685	6.39%	5.89%	5.88%
Information & communication	1,815	7.19%	495	4.62%	5.44%	8.21%
Financial & insurance	875	3.47%	180	1.68%	2.77%	2.26%
Property	1,060	4.20%	345	3.22%	3.51%	3.72%
Professional, scientific & technical	4,150	16.44%	1,340	12.51%	13.83%	17.01%
Business administration & support services	1,960	7.77%	780	7.28%	7.69%	8.57%
Public administration & defence	55	0.22%	45	0.42%	0.51%	0.28%
Education	470	1.86%	155	1.45%	1.73%	1.64%
Health	1,240	4.91%	400	3.73%	3.74%	3.76%
Arts, entertainment, recreation & other services	1,525	6.04%	675	6.30%	6.65%	6.39%
Total	25,240	100.00%	10,715	100.00%	100.00%	100.00%

Source: ONS (2020) UK Business Counts / Lichfields' Analysis

Labour Market

Employment

3.48 Figure 3.13 outlines the economic activity rate (aged 16-64) within the Nottingham Core HMA districts. 4 out of 5 Core HMA districts indicate a rate higher than the rest of the East Midlands (90.3%) and the UK (79.7%); with Broxtowe (81.5%), Erewash (83.4%), Gedling (85.4%) and Rushcliffe (82.2%) all above regional and national averages. Nottingham City has an economic activity rate well below the rest of the Core HMA with 71.0%. This is considerably lower than the regional and national statistics.

Figure 3.13 Economic Activity Rate Aged 16-64: Nottingham Core HMA

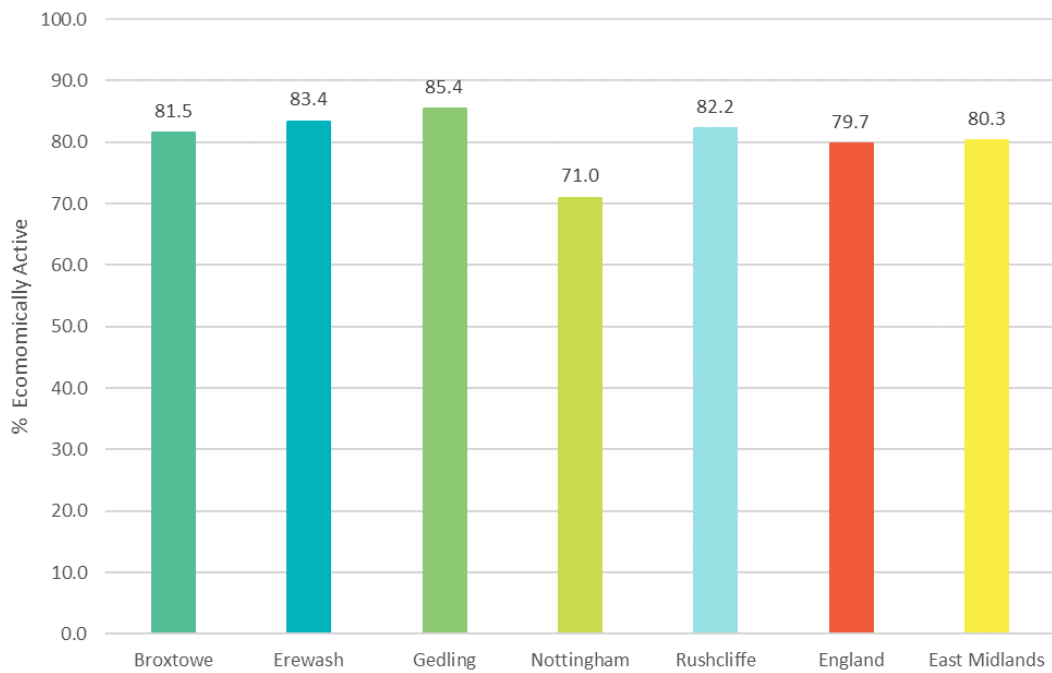

Source: ONS (2020) Annual Population Survey

3.49

Figure 3.14 outlines the economic activity rate (aged 16-64) within the Nottingham Outer HMA Districts. All three of the districts have economic activity rates higher than those across the wider East Midlands (80.3%) and the UK (79.7%); with Ashfield (81.2%), Mansfield (81.1%) and Newark and Sherwood (80.6%).

Figure 3.14 Economic Activity Rate Aged 16-64: Nottingham Outer HMA

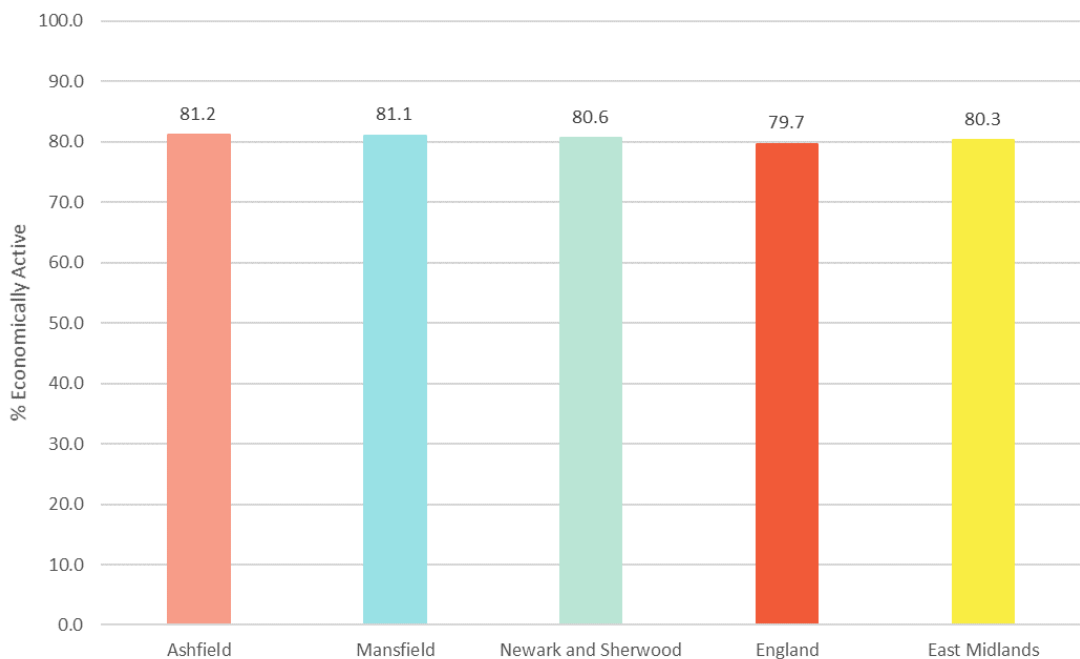

Source: ONS (2020) Annual Population Survey

- 3.50 Generally, the economic activity rates of the Nottingham Core-Outer HMA districts are above the rates of the East Midlands Region and England (again with the exception of Nottingham City).
- 3.51 The economically active populations of all of the Districts have increased over the last 15 years; with Gedling (11.2%) and Mansfield (13.11%) growing dramatically when compared to national (4.05%) and regional (4.02%) average growth. Broxtowe (4.62%), Rushcliffe (4.58%) and Ashfield (6.01%) also showed higher growth than the comparators. However, Erewash (3.09%), Nottingham (2.6%) and Newark and Sherwood (3.07%) have rates below the comparator areas, highlighting their weaker growth over the past 15 years.
- 3.52 Figure 3.15 illustrates the (ONS model-based) unemployment rates in the Nottingham Core HMA and the comparator areas for the years 2004/05 to 2019/20. The Figure highlights that the districts of Broxtowe, Erewash and Gedling have broadly been consistent with, or below, the unemployment rates of the East Midlands and England as whole; with the exception of a peak in Erewash of just under 10% in the year July 2010 to June 2011 and a peak in Gedling Borough of just over 8% in the year July 2012 to June 2013.
- 3.53 Nottingham City has experienced significantly higher unemployment rates than the rest of Districts and indeed the comparators over the last 15 years; with a peak of over 14% in the year July 2012 to June 2013. Rushcliffe on the other hand has experienced consistently low unemployment rates, falling from a peak of c.6% in July 2010 to June 2011 to just above 2% currently. Unemployment rates are currently decreasing (as of June 2020), with the Core HMA averaging 3.8%, when compared to 3.9% nationally and regionally. This is likely to increase significantly in the months ahead due to the pandemic and the resultant economic crisis.

Figure 3.15 Unemployment Rate Aged 16+ Nottingham Core HMA (2004/05 to 2019/20)

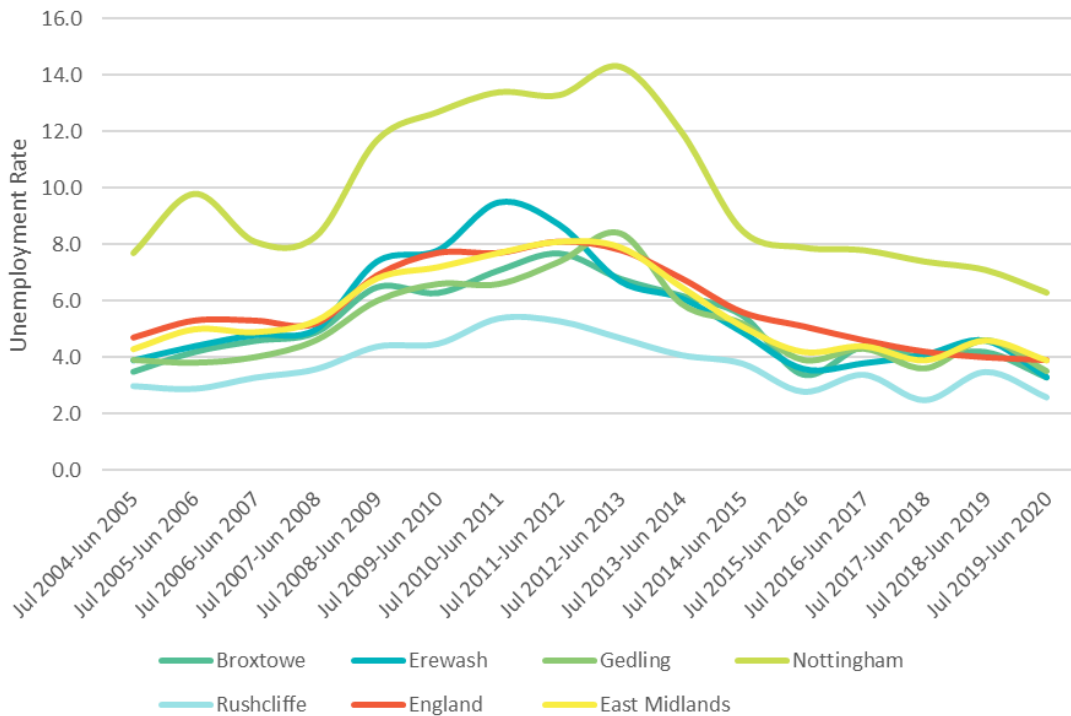

Source: ONS (2020) Annual Population Survey April July 2004 - June 2005 to July 2019 - June 2020

3.54

Figure 3.16 illustrates the (ONS model-based) unemployment rates in the Nottingham Outer HMA and the comparator areas for the years 2004/05 to 2019/20. The Figure highlights that Mansfield District has generally experienced higher levels of unemployment over the past 15 years than the East Midlands and national average, with a peak of nearly 11% in the year July 2010 to June 2011. Ashfield District has tended to align with the regional and national levels but did experience a significant divergence through the years July 2009/June 2010 to July 2014/June 2015, reaching a peak of just over 10% in the year July 2011 to June 2012. Newark and Sherwood on the other hand has generally experienced lower unemployment rates than the regional and national comparators over the past 15 years. Unemployment peaked here in 2012 and 2013 with levels approaching 7%. As with the Nottingham Core HMA, the unemployment rates are currently decreasing (as of June 2020) but are still above nationally and regional figures at 4.1%; this is likely to increase significantly as a result of the pandemic’s economic impacts.

Figure 3.16 Unemployment Rate Aged 16+ Nottingham Outer HMA (2004/05 to 2019/20)

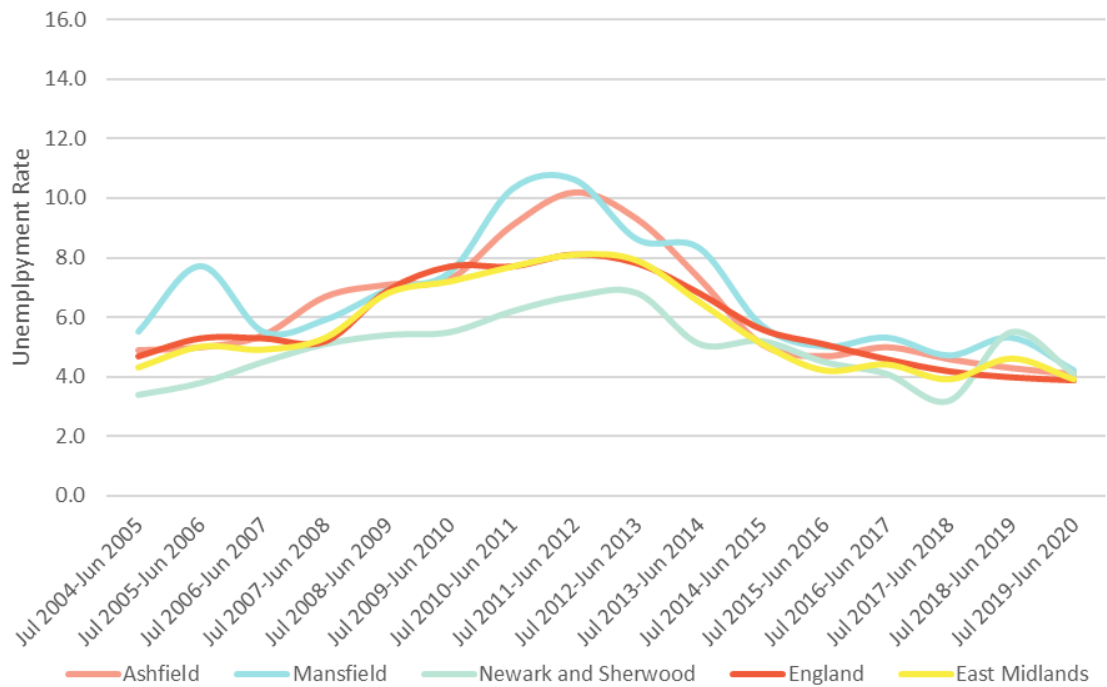

Source: ONS (2020) Annual Population Survey April July 2004 - June 2005 to July 2019 - June 2020

Occupations

3.55 Figure 3.17 and Figure 3.18 outline the proportion of the Nottingham Core and Outer HMA’s who are employed in certain occupation grades (as of 2019/2020), against the number of regional and national comparators.

3.56 The Core HMA generally aligns with the rest of the East Midlands and the UK in the composition of its workforce occupations. Some modest disparities occur at a regional level in some sectors, with 21.8% of the Core HMA’s workforce made up of people working in Professional Occupations, which contrasts with the rest of the East Midlands where this figure is 17.8%. At a national level, the Core HMA has proportionately fewer people working within the Associate Professional & Technical Occupations (13.7%) than the UK (14.9%). Across both comparators, the Core HMA has some differences relating to Skilled Trades Occupations, with only 8.6% of all people in employment classified as working in this occupation, compared to 11.5% across the East Midlands and 9.8% across the UK.

Figure 3.17 Workforce Occupations for Nottingham Core HMA (Jul 2019 - Jun 2020)

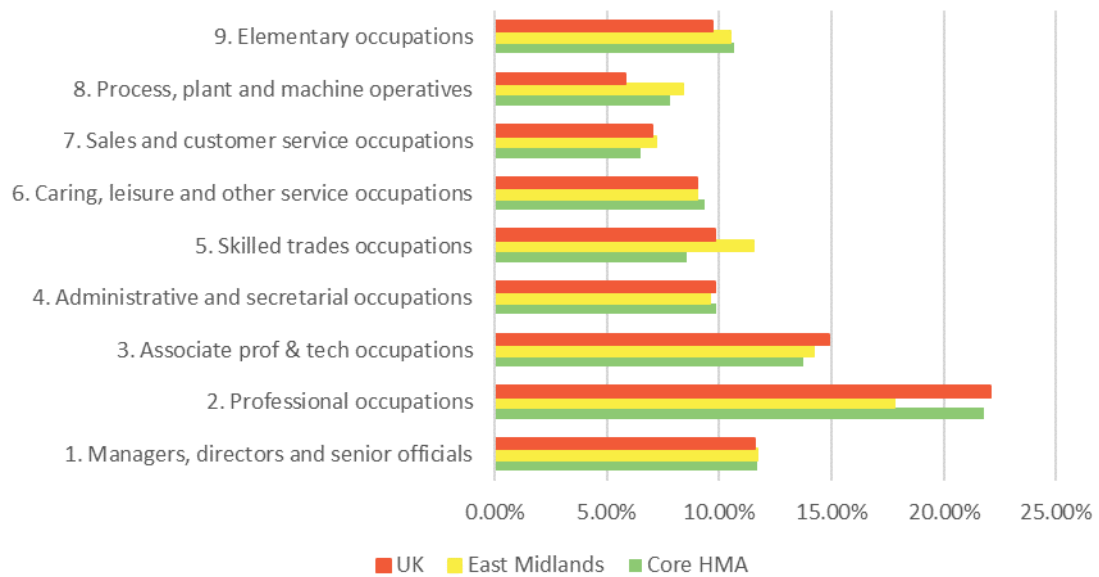

Source: ONS (2020) Annual Population Survey - Occupations

3-57

The Outer HMA indicates some striking differences between regional and UK comparators. This is most evident when observing the level of residents employed in Skilled Trades Occupations. The Outer HMA also has fewer people employed in Professional Occupations (14.9%) than the East Midlands (17.8%) and more particularly the UK (22.1%). Furthermore, when compared to the East Midlands and the UK fewer people work within the Associate Professional & Tech Occupations and Administrative and Secretarial Occupations.

Figure 3.18 Workforce Occupations for Nottingham Outer HMA (Jul 2019 - Jun 2020)

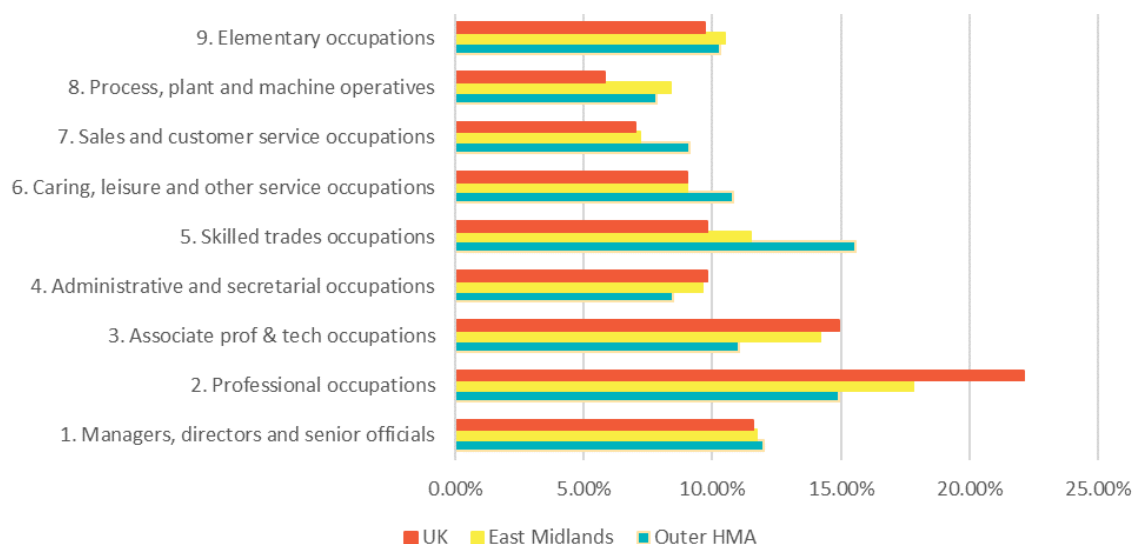

Source: ONS (2020) Annual Population Survey - Occupations

Location Quotients

3-58

Whilst recent Government policy has focused on spatial led growth models, there is an increasing need for, and shift towards, sector-based growth models.

- 3.59 In order to identify the full economic potential of the Nottingham Core-Outer HMA, it is important to revisit which industrial sectors are best placed to drive future growth. This is informed by an understanding of which sectors are under or over-represented in terms of local employment and their recent growth performance.
- 3.60 Figure 3.19 and Figure 3.20 assesses the Nottingham Core-Outer HMA's current sectoral strengths through the use of location quotients, which measure the proportion of employment in an industry at the local authority level relative to the regional average. In the graph, the location quotients are shown using an orange bar. A value above 1.0 denotes a higher local representation of a sector compared to the UK average, whilst anything below 1.0 signifies an under-representation. The further the orange bar is from 1.0, the greater the extent of any over or under-representation. In addition, the blue bars show the absolute level of employment accounted for by each sector.
- 3.61 Figure 3.19 indicates that the Core HMA has an extremely strong employment representation in Utilities, Special Construction Activities, Retail, Public Administration and Defence, Health, Education, Computer and Information Services, and Administrative and Supportive Services compared with the rest of the UK. Retail, Health, Education and the Administrative and Supportive Services sectors also employ very high levels of workers in absolute terms.
- 3.62 Conversely, the chart also illustrates the relatively low rate of employment in some white-collar service sectors; with Finance Sector and Professional Services under-represented when compared to the UK, despite the City of Nottingham being included within the Core HMA.

Figure 3.19 Location Quotients of Economic Sectors in Nottingham Core HMA, 2018

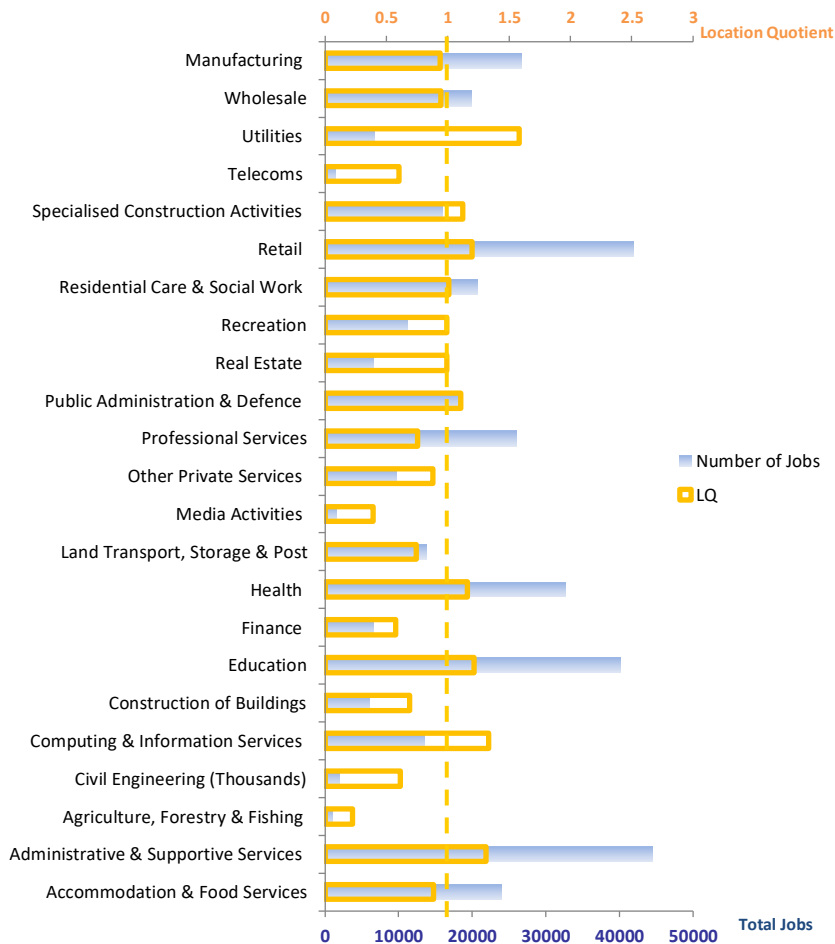

Source: Experian 2020 / Lichfields' Analysis

3.63 Figure 3.20 indicates that the Outer HMA has an extremely strong employment representation in Manufacturing, Wholesale, Utilities, Special Construction Activities, Residential Care and Social Work, and Civil Engineering sectors compared with the rest of the UK. Manufacturing and Retail sectors also employ very high levels of workers in absolute terms.

3.64 The chart also illustrates again that there is a relatively low rate of employment in the more white-collar service sectors; with Finance Sector, Professional Services, and Public Sector and Defence sectors under-represented when compared to the UK. Computer & Information Services are also under-represented.

Figure 3.20 Location Quotients of Economic Sectors in Nottingham Outer HMA, 2018

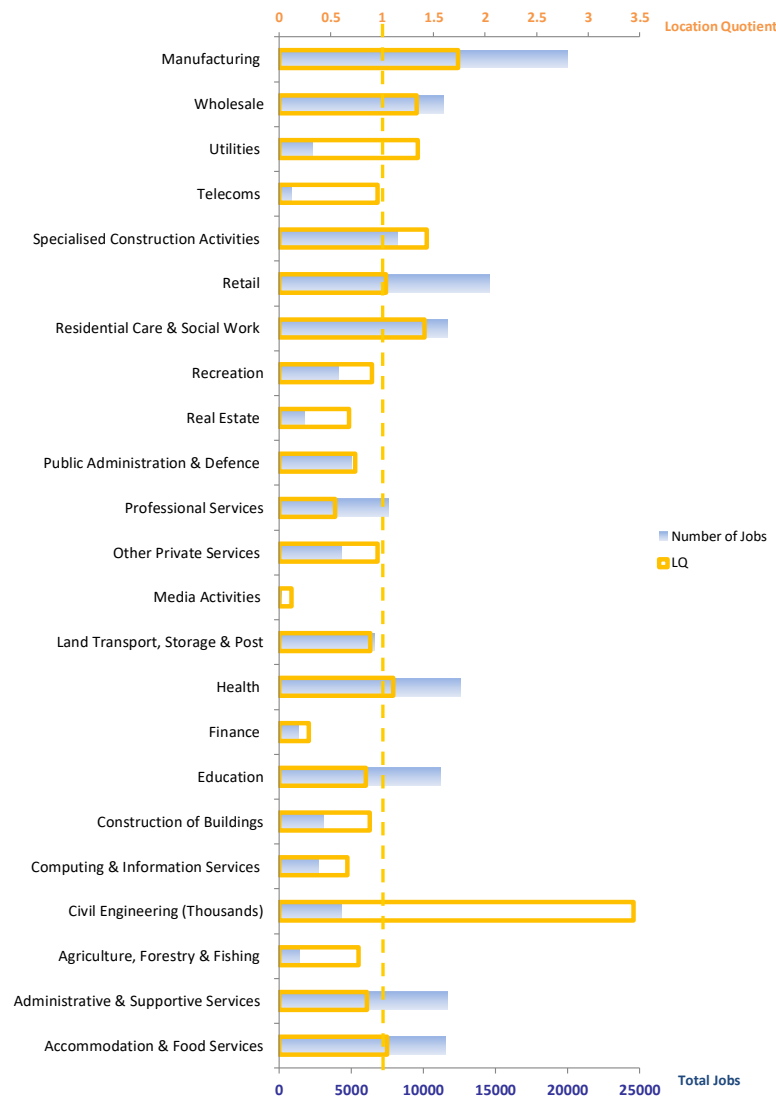

Source: Experian 2020 / Lichfields Analysis

Skills and Qualifications

3.65 Figure 3.21 and Figure 3.22 presents the qualification levels of residents aged 16 to 64 for both the Nottingham Core HMA and Outer HMA.

3.66 Figure 3.21 indicates that the Nottingham Core HMA generally has a well-qualified resident workforce when compared to the rest of the East Midlands and England, with Broxtowe and Rushcliffe in particular indicating a high proportion of qualified residents when compared to the regional and national statistics; especially when considering residents educated to degree level and above. Nottingham City stands out from the rest of the Core Districts as it not only indicates a low qualified resident population but also a high proportion (10.1%) of residents with no qualifications when compared to national (7.5%) and regional (7.4%) statistics.

Figure 3.21 Qualifications of People Aged 16-64: Nottingham Core HMA

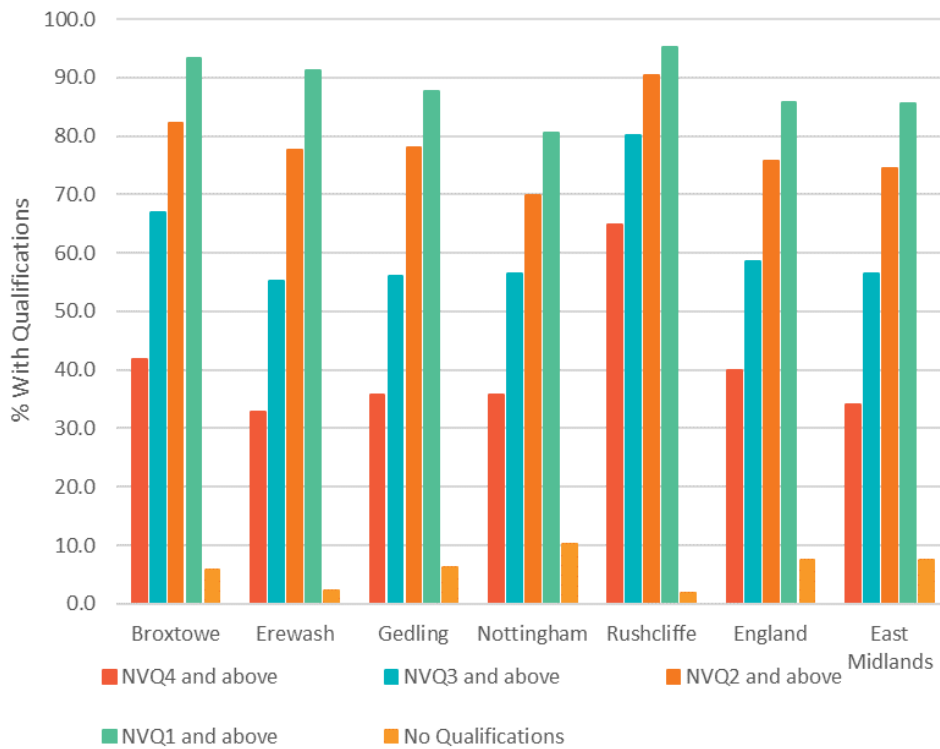

Source: ONS (2020): Annual Population Survey

3.67

Figure 3.22 indicates the Nottingham Outer HMA has a relatively poorly-qualified workforce when compared to the East Midlands and England as a whole. Mansfield and Newark and Sherwood show a particularly low-level skillset amongst their workforce with only 80% and 79.6% of the working population respectively holding GCSE level qualifications and above. This is compared to 85.5% in the East Midlands and 85.8% in England. All districts additionally lack workers skilled to degree level and above with Ashfield (21.2%), Mansfield (22.2%), and Newark and Sherwood (33.1), all falling well below the national figure (40.0%) and just below the figure for the East Midlands (34.1%).

Figure 3.22 Qualifications of People Aged 16-64: Nottingham Outer HMA

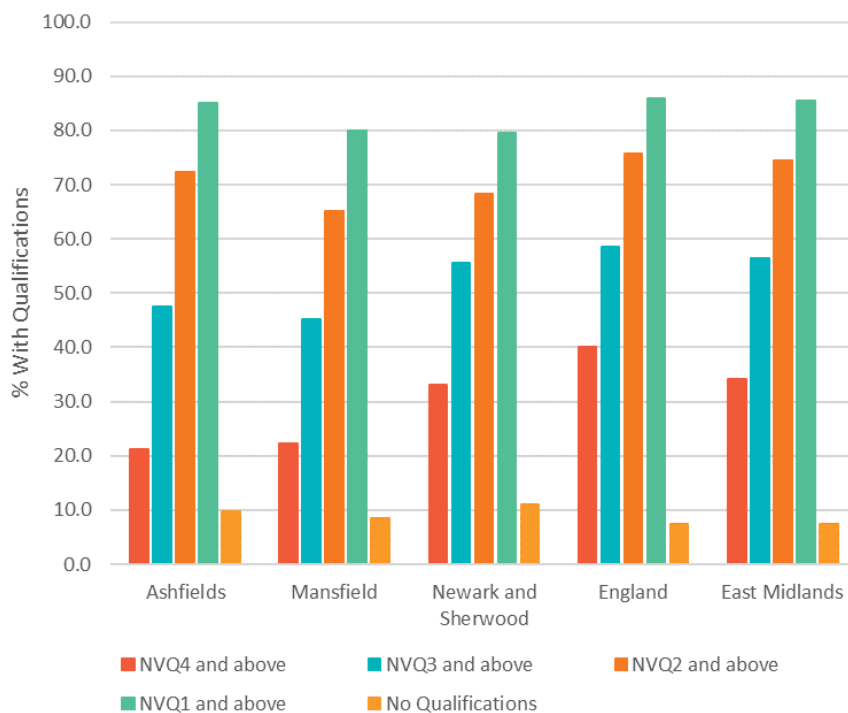

Source: ONS (2020): Annual Population Survey

Earnings

3.68 Figure 3.23 and Figure 3.24 compare changes to the gross median annual earnings in the Nottingham Core and Outer HMA, the East Midlands and the UK between 2010 and 2020³¹.

3.69 Earnings for the Core HMA’s residents (Figure 3.23) have generally aligned with the national average over the last 10 years, with a slight positive fluctuation in 2016 and a negative fluctuation in 2018. Residents earnings have been significantly higher than the East Midlands average over the last 10 years and are currently £30,474 compared to the region’s £29,430; although this level is below the UK median gross annual earnings of £31,461.

3.70 Workplace-based earnings have been below the UK average over the past 10 years but have generally been above the East Midlands average with the exception of figures for 2011 and 2020. Workplace-based earnings have been consistently lower than resident-based earnings over the last 10 years in the Core HMA, with the current figure at £27,986.

3.71 Both resident-based earnings and workplace-based earnings have grown at slower rates in the Core HMA than the comparators between 2010 and 2020. Resident earnings have grown by 19% compared to 21% in the East Midlands and 22% in the UK. Workplace-based earnings have also grown at a slower rate, by just 16.7% when compared to the East Midlands (21.4%) and the UK as whole.

³¹ ONS (2020): Annual Survey of Hours and Earnings

Figure 3.23 Core HMA Resident and Workplace Gross Median Annual Earnings 2010-2020

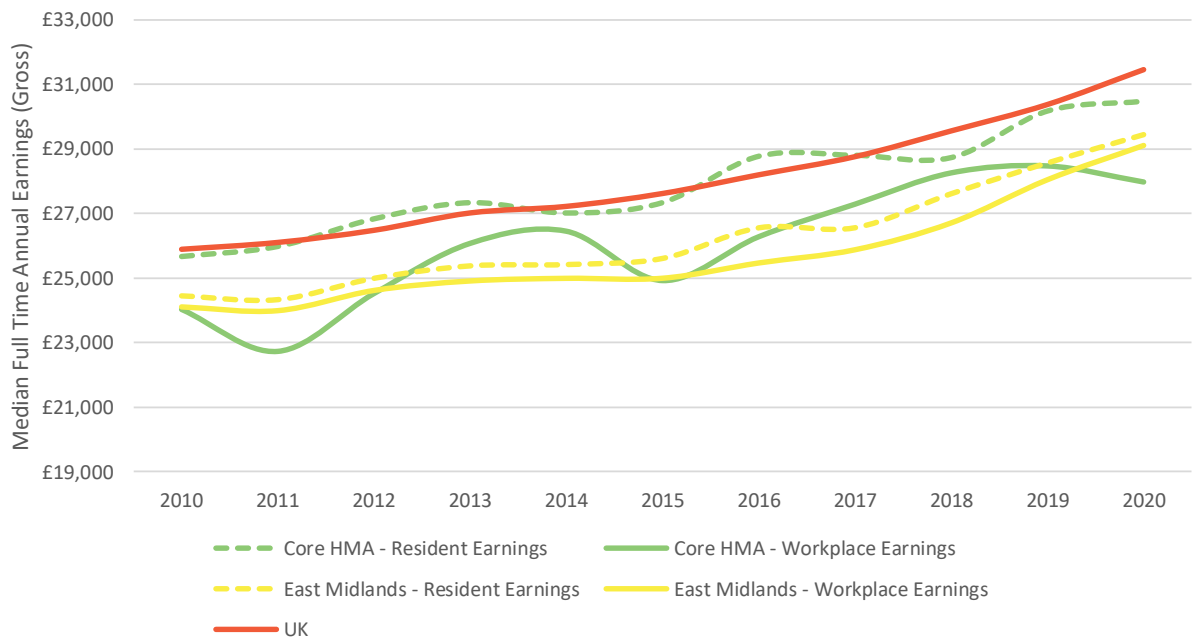

Source: ONS (2020): Annual Survey of Hours and Earnings

3.72 The Outer HMA’s resident-based earnings and workplace-based earnings (Figure 3.24) have been consistently lower than the UK and East Midlands average over the last 10 years. Resident-based earnings have grown in recent years to reach a level of £27,393 in 2020, however this is still below the East Midlands average of £29,430 and well below the UK average of £31,461.

3.73 Workplace-based earnings have been even further below the East Midlands and UK average over the past 10 years; with the 2020 figure at £25,956 compared to £29,102 in the East Midlands and £31,461 in the UK as a whole. Additionally, workplace-based earnings have been consistently lower than resident-based earnings over the last 10 years in the Outer HMA.

3.74 Resident earnings have grown at a higher rate than both comparators in the Outer HMA; with a 24.7% growth figure over the last 10 years; compared to 21% in the East Midlands and 22% in the UK. This growth has been particularly strong in recent years. Workplace-based earnings have grown at a slower rate, by just 19.5%, compared to the East Midlands (21.4%) and the UK as whole.

Figure 3.24 Outer HMA Resident and Workplace Gross Median Annual Earnings 2010-2020

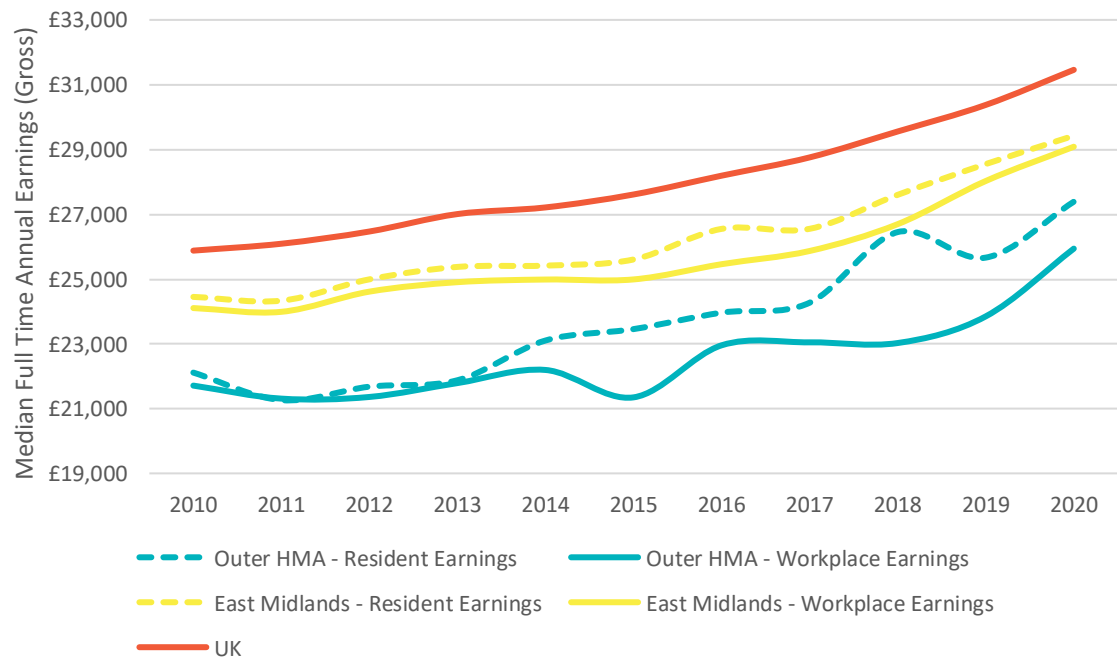

Source: ONS (2020) Annual Survey of Hours and Earnings

Population Demographics

3.75 Figure 3.25 and Figure 3.26 illustrate the population age structure for the Nottingham Core and Outer HMA³².

3.76 A total of 799,384 people currently live in the Nottingham Core HMA. Overall, there is a ratio of 50.2 females to 49.8 males, which is slightly different to the national average, which has a higher proportion of females (50.6%). 65.6% of the total population in the Nottingham Core HMA (524,594 people) are of working age (between 16 and 65). This is a slightly higher proportion than the East Midlands (61.9%) and England as a whole (62.4%). The Core HMA also has a slightly lower proportion of over 65s living in the area, at 136,649 residents, or 17.1% of the population, compared with 18.4% across England as a whole and 19.5% in the East Midlands.

³² ONS (2020): Population estimates 2019

Figure 3.25 Nottingham Core HMA Population Age Structure (2019)

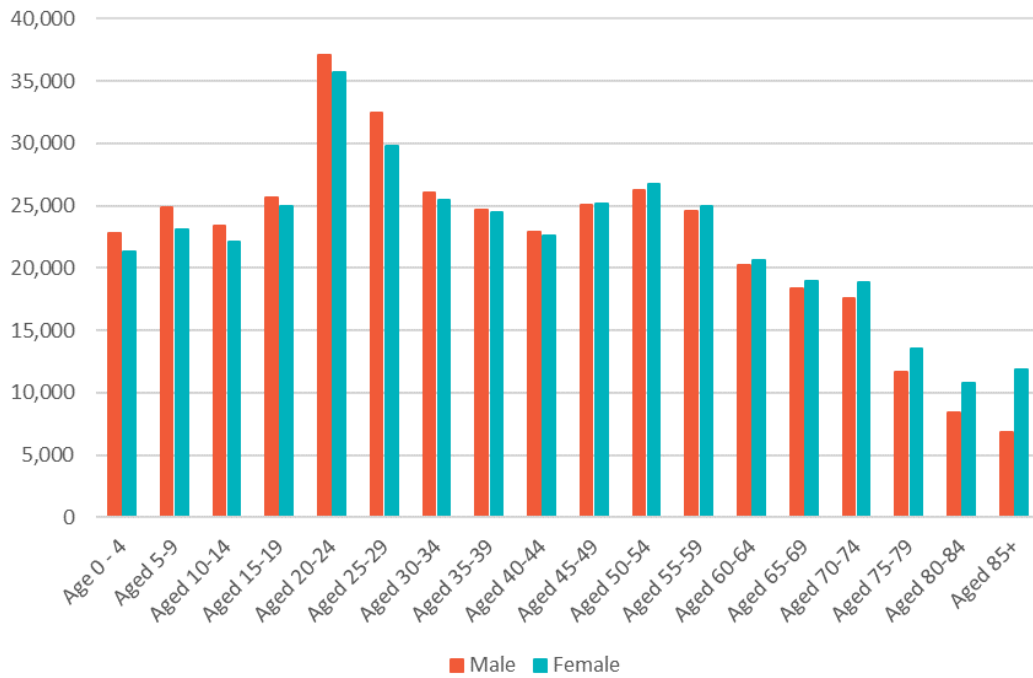

Source: ONS (2020) Population Estimates 2019

3.77

A total of 359,652 people currently live in the Nottingham Outer HMA. Overall, there is a ratio of 50.8 females to 49.2 males, which is very similar to the national average, where there is a ratio of 50.6 to 49.4 males. 62.2% of the total population in the Nottingham Outer HMA (223,847 people) are of working age (between 16 and 65). This is a slightly higher proportion than the East Midlands (61.9%) but slightly below England as a whole (62.4%). The Outer HMA also has a higher proportion of over 65s living in the area, at 73,125 residents, or 20.3% of the population, compared with 18.4% across England as a whole and 19.5% in the East Midlands.

Figure 3.26 Nottingham Outer HMA Population Age Structure (2019)

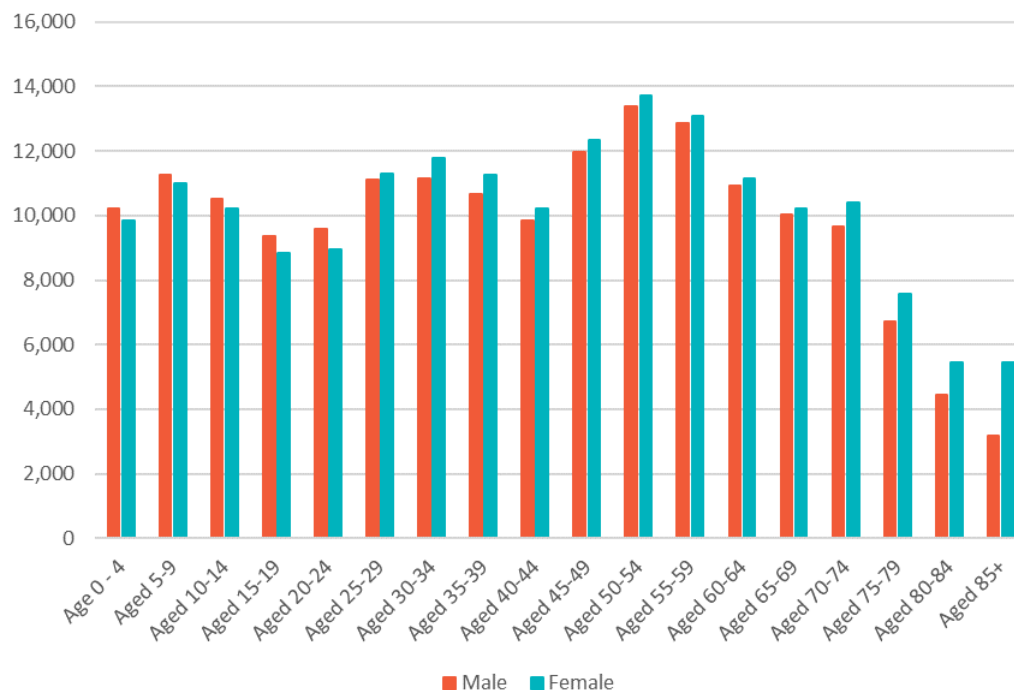

Source: ONS (2020) Population Estimates 2019

3.78 Population growth in the Nottingham Core HMA has been varied when compared to the East Midlands and England as a whole. According to the ONS’s 2018-based Sub-National Population Projections [SNPP], the Core HMA’s population grew by 8.3% between 2009 and 2019 which is similar to the rest of the East Midlands (8.15%) and higher than the national level (7.84%). The Outer HMA on the other hand has witnessed slower growth, 7.2% over the past 10 years, which is similar to the rest of the country, but lower than the regional figures.

3.79 The working age population in Nottingham Core HMA has grown by 5.24% between 2009 and 2019, which is considerably more than the rate for the East Midlands (3.38%) and England (3.61%). This would suggest the Nottingham Core HMA is being replenished by younger people quicker than elsewhere in the East Midlands and the country as a whole. This contrasts with the Outer HMA where the working age population has grown by just 2.0%, indicating a lower replenishment of younger people than the comparators over the past 10 years.

3.80 In this regard, the 2018-based SNPP indicate that Nottingham Core HMA’s population growth will be around 72,523 between 2018 and 2038, a growth rate of 9.12% which is significantly lower than the East Midlands rate of 12.0% and higher than the national rate of 8.6%. The Outer HMA’s population, however, is projected to grow by 44,974, at a growth rate of 12.58%, which is significantly higher than the national rate and higher than the regional rate.

3.81 As can be seen from Table 3.9, this growth is not just confined to very high levels of projected growth in the 65+ age groups (which are projected to increase by a very substantial 37% for the Core HMA and 44.7% for the Outer HMA over the next 20 years). The crucial working age demographic indicates that the sub-

region is set to gain 23,072 residents of working age in the Core HMA and 12,274 in the Outer HMA. This an increase of 4.5% and 5.6% respectively on current 2018 levels and represents higher than national (2.9%) rates of growth.

Table 3.9 Population Growth for Nottingham Core-Outer HMA and comparator areas 2018-38

	Net Total Growth	Total Growth %	Working Age Growth	Working Age Growth %	Age 65+ Growth	Age 65+ Growth %
Nottingham Core HMA	72,523	9.1%	23,072	4.5%	49,796	37.0%
Nottingham Outer HMA	44,974	12.6%	12,274	5.6%	32,012	44.7%
East Midlands	577,122	12.0%	166,095	5.6%	399,798	43.1%
England	4,789,073	8.6%	1,016,609	2.9%	4,150,711	40.8%

Source: ONS (2020): 2018-based Sub-National Population Projections

Deprivation

3.82

Figure 3.24 shows hotspots of deprivation across the Nottingham Core-Outer HMAs using the latest 2019 data from the ONS Indices of Multiple Deprivation [IMD]. High levels of deprivation remain within the inner urban areas of Nottingham City, Mansfield and Ashfield; with areas ranked in the top 10% and top 20% of most deprived areas in the country. The surrounding rural areas and sub urban Nottingham tend to be considerably more affluent, with much of Newark & Sherwood, Rushcliffe, Broxtowe, Gedling and Erewash in the least deprived categories. The 2019 IMD suggests that Nottingham City is one of the most deprived local authorities in England, ranked 10th out of 326 (based on 'rank of average rank'). It is followed by Mansfield (56th), Ashfield (63rd), Newark and Sherwood (148th), Erewash (168th), Gedling (207th), Broxtowe (223rd) and Rushcliffe, which is ranked at 314th – one of the most affluent.

Figure 3.27 Rank of Indices of Multiple Deprivation in the Nottingham Core-Outer HMA

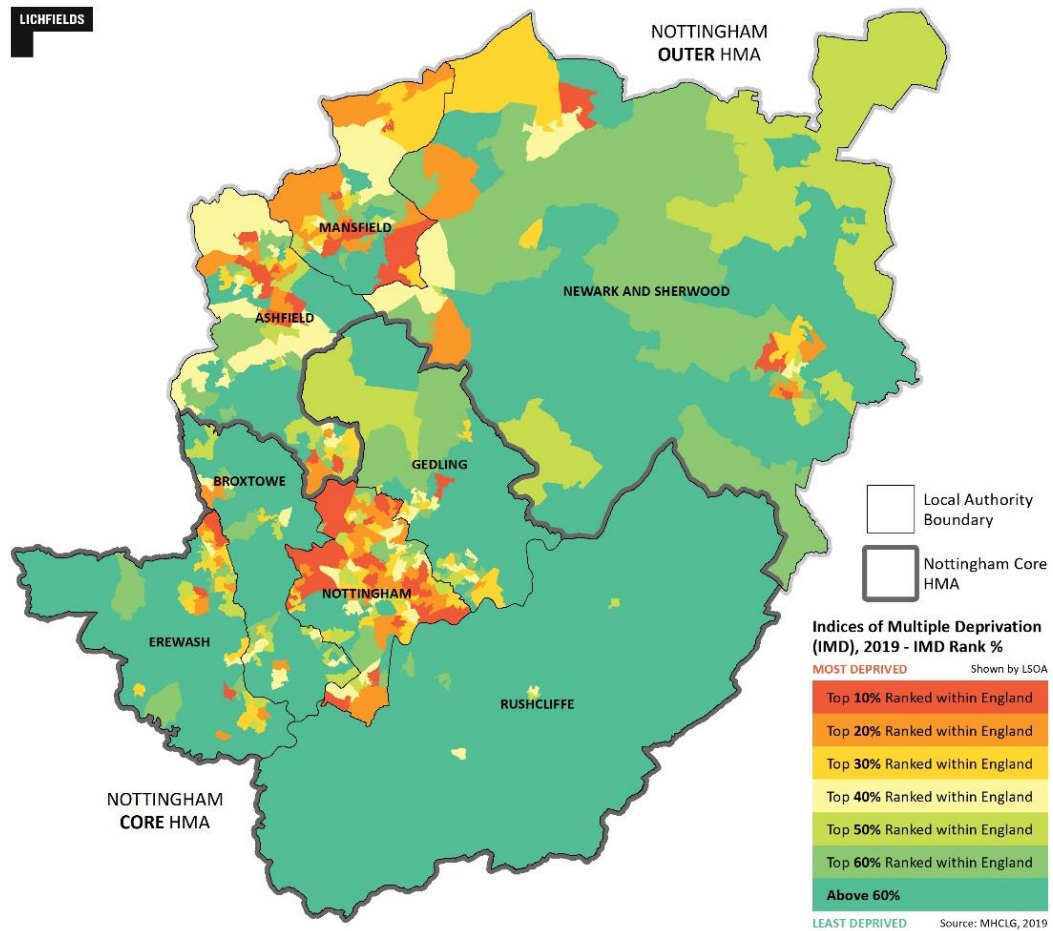

Source: Lichfields analysis, drawing upon ONS Indices of Multiple Deprivation 2019

SWOT Analysis

3.83

The main Strengths, Weaknesses, Opportunities and Threats facing the Nottingham Core-Outer HMA are summarised in Table 3.10. This takes into account the current Covid-19 crisis and the current situation regarding Brexit.

Table 3.10 SWOT analysis

Current Strengths	Current Weaknesses
-------------------	--------------------

<ul style="list-style-type: none"> • Nottingham Core-Outer HMA centrally located with excellent transport and infrastructure links to the rest of the UK and abroad • Nottingham Outer HMA has experienced stronger employment growth (1.25% CAGR) than either regional (0.77%) or national (0.95%) comparators in recent years • The Outer HMA has seen a growth in its total stock of employment space since the millennium, driven by strong increases in both industrial and office space • Businesses that locate in the Nottingham Core-Outer HMA tend to have slightly higher survival rates than might be expected elsewhere • The economic activity rates of the Nottingham Core-Outer HMA Districts are above the rates of the East Midlands region and England; with the exception of Nottingham City • The Core HMA has a high proportion of residents who are employed in Professional Occupations when compared to the East Midlands, with 21.8% of all people in employment classified as working in this occupation, compared to 17.8% • The Outer HMA has a high proportion of residents who are employed in Skilled Trades Occupations, with 15.6% of all people in employment classified as working in this occupation, compared to 11.5% regionally and 9.8% across the UK • The Core HMA has a well-qualified workforce, with more residents with higher-level qualifications compared to the East Midlands and England • Lower workplace earnings in the Outer HMA are attractive to businesses • The Retail, Health, and Admin sectors are all strong within the Core HMA and the Manufacturing sector is strong in the Outer HMA 	<ul style="list-style-type: none"> • There are significant pockets of deprivation across the sub-region, focused primarily within the urban areas • Nottingham Core HMA has experienced weaker employment growth (0.5% CAGR) than either regional (0.77%) or national (0.95%) comparators in recent years • Generally lower than average qualifications across the sub-region, especially within the Outer HMA which has low levels of the population educated to degree level and above • The Core HMA has seen a significant decrease in its total stock of employment space since the millennium, which has been driven by a loss of nearly 20% of industrial floorspace • Over half of all B-class units in the Core (67.1%) and Outer (58.6%) HMA were built pre 1970, with a large amount of these units pre 1940 • Historic rate of commercial floorspace replacement has been lower in the Core HMA than in the comparator areas • Nottingham City has a very low economic activity rate when compared to the rest of the sub-region and the comparators • The Outer HMA has a lower proportion of its population working within white-collar occupations
<p>Current Opportunities</p>	<p>Current Threats</p>
<ul style="list-style-type: none"> • Strong employment growth across the Core-Outer HMA, equal to +64,600 net jobs growth 2018-38, even accounting for the Pandemic and Brexit • Working age population growth across the Core-Outer HMA projected to be above national figures • The Health, Residential Care & Social Work, Information and Communication and Profession & Other Private Services sectors are forecast to drive future job growth in Nottingham Core-Outer HMA. This represents excellent opportunities to upskill the population of the sub-region • Rise of homeworking likely to continue as technology advances, the Pandemic, and the highly attractive natural environment will continue to encourage successful individuals to move to the area • Large base of smaller businesses means their space requirements are generally more flexible 	<ul style="list-style-type: none"> • Experian forecast an initial fall of 24,900 jobs across the Core-Outer HMA due primarily to the Pandemic, with the recovery more protracted than elsewhere • Unprecedented economic uncertainty resulting from the Pandemic and the impacts of the third lockdown, which are not reflected in the latest Experian job forecasts • The high level of home working as a result of the Pandemic may mean that future patterns of working are permanently changed, which may have a serious knock-on effect on the need for new office space • The current uncertainty regarding the terms and effects of the EU Trade Deal is harming business investment, and continued uncertainty and disruption will harm businesses • Unemployment rates in the Outer HMA are higher than the comparators, with the rate very likely to increase substantially (as elsewhere) • Manufacturing sectoral employment is forecast to decline considerably in both the Core and Outer HMA • Vulnerability to automation of the relatively low-skilled workforce of the manufacturing sector in the Outer HMA. There is lower than average white-collar employment and lower than average levels of qualifications, combined with areas of significant deprivation.

4.0 **Functional Economic Market Area**

4.1 This section provides a broad overview of the two HMAs encompassing the 8 districts and its likely position within 2 wider Functional Economic Market Areas [FEMA]. The following provides an up to date analysis of the extent of the FEMA(s) in accordance with the guidance contained within the 2019 PPG, using the latest data on migration and commuting levels.

4.2 The methodology adopted for this study follows the PPG approach on defining FEMAs within and across local authority areas³³.

4.3 The PPG notes that since patterns of economic activity vary from place to place, there is no standard approach to defining a FEMA. However, it is possible to define them taking account of the following factors³⁴:

- *“extent of any Local Enterprise Partnership within the area;*
- *travel to work areas;*
- *housing market area;*
- *flow of goods, services and information within the local economy;*
- *service market for consumers;*
- *administrative area;*
- *catchment areas of facilities providing cultural and social well-being; and,*
- *transport network.”*

Defining the FEMA

Nottingham Core HMA and Nottingham Outer HMA Employment Land Forecasting Study [ELFS]

4.4 The 2015 Nottingham Core HMA and Nottingham Outer HMA Employment Land Forecasting Study [ELFS] considered that the Core HMA formed a distinct self-contained FEMA, although applying the FEMA tests for the three Outer HMA districts was slightly less clear cut. On the basis of the assessment the ELFS concluded that an argument could be made that the Outer HMA was also a self-contained FEMA. For the town of Hucknall, the study considered that whilst Hucknall was within the administrative boundaries of Ashfield/Outer HMA, it was highly connected to the Core HMA and could be viewed as being located within that FEMA:

“For Hucknall the analysis identifies that of the residents in employment, 6,484 work in Hucknall or the rest of Ashfield, while 6,763 commute to the five Core HMA authorities. Whilst Hucknall is within the administrative boundaries of Ashfield/Outer HMA, it is highly connected to the Core HMA and could be viewed as being located within that FEMA.” [paragraph 2.100]

³³ Reference ID: 61-018-20190315

³⁴ Reference ID: 61-019-20190315

Extent of the Local Enterprise Partnership

- 4.5 The Nottingham Core-Outer HMA is within the counties of Nottinghamshire and Derbyshire and is bordered by the authority areas of Amber Valley, Bolsover, Bassetlaw, West Lindsey, North Kesteven, South Kesteven, Melton, Charnwood, North West Leicestershire, South Derbyshire and Derby.
- 4.6 The nearest major settlements to the Core-Outer HMA are Derby, Loughborough, Chesterfield, Lincoln and Grantham. The Core-Outer HMA is also located near to the Sheffield City Region area. The Core-Outer HMA is well connected to the North of England and London via the M1 motorway, the A1 motorway and the East Midland Rail Network with services provided throughout the HMA along the Midland Main Line. Furthermore, Northern Rail operates direct services to/from Leeds and Nottingham and the East Coast Main Line runs along the eastern side of the study area with a station at Newark Northgate; this provides direct linkages to London Kings Cross, Yorkshire, the North East and Scotland. The nearby East Midlands Airport additionally provides national and international connections for business and leisure visitors
- 4.7 The Nottingham Core-Outer HMA is situated in the D2N2 LEP area alongside the rest of Derby, Derbyshire, Nottingham and Nottinghamshire. D2N2 is one of the largest LEPs in England, with a population of more than two million people and with an economic output of over £42.9billion GVA (Gross Value Added).³⁵
- 4.8 The D2N2 LEP Strategic Economic Plan [SEP] Vision 2030 addresses the vision and key objectives for the LEP up until 2030; with this economic strategy for the region forming the basis for future investment decisions by the LEP and its partners. The plan sets out the blueprint for growth over the next decade and outlines targets aimed at: bringing up to £9 billion in added value to the D2N2 economy, boosting the D2N2's productivity into the top 25% in Europe, raising earnings, narrowing inequality, and sharing prosperity across all parts of the two cities and counties.
- 4.9 The SEP identifies that 6 housing market areas exist within the LEP; however, the partnership area is dealt with as a single entity. That said, the D2N2 Economic and Policy Review (2018) which informed the SEP accepted that the Nottingham Core HMA and Nottingham Outer HMA were separate housing market areas and as such the LEP helps to define the FEMA.

Travel-to-Work Areas

- 4.10 Detailed guidance on how to define a FEMA is provided by CLG³⁶. This states that examining commuting flows can help to define the FEMA of an economy. These commuting flows can be assessed using the latest travel-to-work flow data from the 2011 Census.
- 4.11 The ONS defines labour market areas as those areas where the bulk of the resident population also work. Defining labour market areas requires an analysis of commuting patterns to identify Travel to Work Areas [TTWAs] for

³⁵ D2N2 (2020): *About Us*

³⁶ CLG (2010) *Functional Economic Market Areas: An Economic Note*

local economies. The current criteria for defining TTWAs is that at least 75% of an area's working population work in the area and at least 75% of the people who work in the area also live in the area. The area must also have a working population of at least 3,500. However, for areas with a working population in excess of 25,000, self-containment rates as low as 66.7% are accepted to define a TTWA as part of a limited “trade-off” between workforce size and level of self-containment³⁷.

4.12 TTWAs provide a good indication of which labour market a location or local authority is in and how labour market areas are split across the UK. The ONS published 2011 TTWAs for the UK in August 2015. These were developed to approximate self-contained labour market areas i.e. areas where most people both live and work and therefore relatively few commuters cross a TTWA boundary on their way to work.

4.13 The ONS 2011 TTWA mapping (Figure 4.1) suggests that Nottingham Core-Outer HMA cuts across the Mansfield, Lincoln, Nottingham and Derby TTWA.

Figure 4.1 Travel to Work Areas 2011



Source: ONS (2015): TTWAs 2011

4.14 This section has been informed by Lichfields’ 2015 analysis, which examined the same 2011 Census data as part of the Nottingham Core and Nottingham Outer HMA Employment Land Forecasting Study; the conclusions made by the study in terms of TTWAs remain largely valid as the commuting data has not been updated.

³⁷ Commuting to work, Changes to Travel to Work Areas: 2001 to 2011 (ONS, December 2015)

4.15 In terms of commuting flows, at the time of the 2011 Census, 275,554 residents lived and worked in the Core HMA, with Nottingham City by far the biggest draw attracting 20,015 commuters living in Gedling, 15,394 from Broxtowe and 15,002 from Rushcliffe.

4.16 Figure 4.2 indicates that the Core HMA has strong linkages with the three Outer HMA districts, with 7,769 Core HMA residents commuting into Ashfield on a daily basis for work, 2,910 commuting into Mansfield and 4,080 into Newark and Sherwood. A large number of the Core HMA’s residents also commute into Derby, with 10,901 travelling there daily (6,348 from Erewash alone).

Figure 4.2 Nottingham Core HMA Commuting Flows

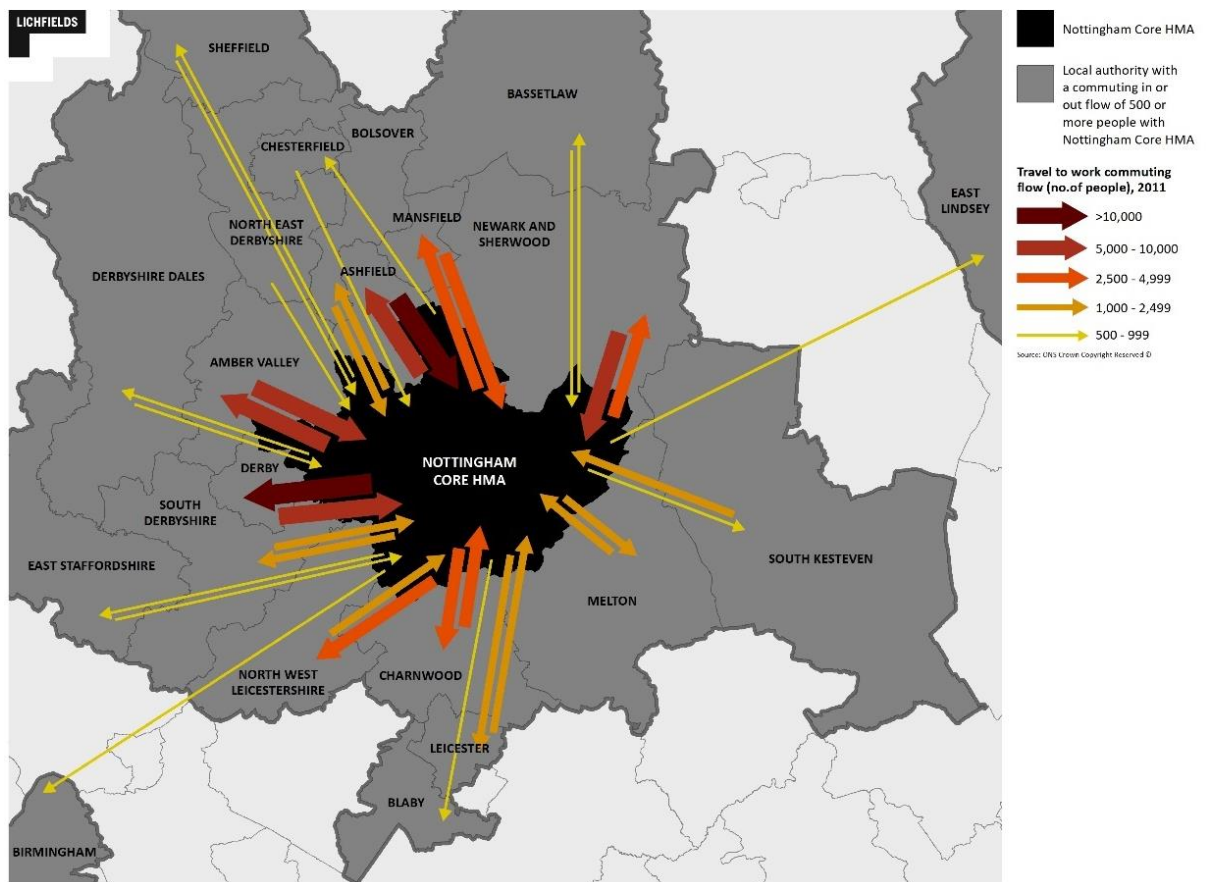

Source: ONS Census 2011 / Lichfields Analysis

4.17 At the time of the 2011 Census, 107,107 people lived and worked within the Outer HMA districts, with again strong linkages between the Core and Outer HMA evident. 14,759 Core HMA residents travel into the three Outer HMA districts on a daily basis for work. Linkages are particularly strong with Gedling, which contributes 4,494 of the Outer HMA’s workforce. As shown in Figure 4.3, there are particularly strong linkages between the Outer HMA and Bolsover, Bassetlaw and Amber Valley.

4.18 Overall, the Outer HMA has a net out-commuting rate of 13,214, with these people predominantly commuting to the Core HMA (in particular Nottingham City). Ashfield has a net out-commuting rate of 2,221; with Mansfield’s at 7,371, and Newark and Sherwood at 3,622.

Figure 4.3 Nottingham Outer HMA Commuting Flows

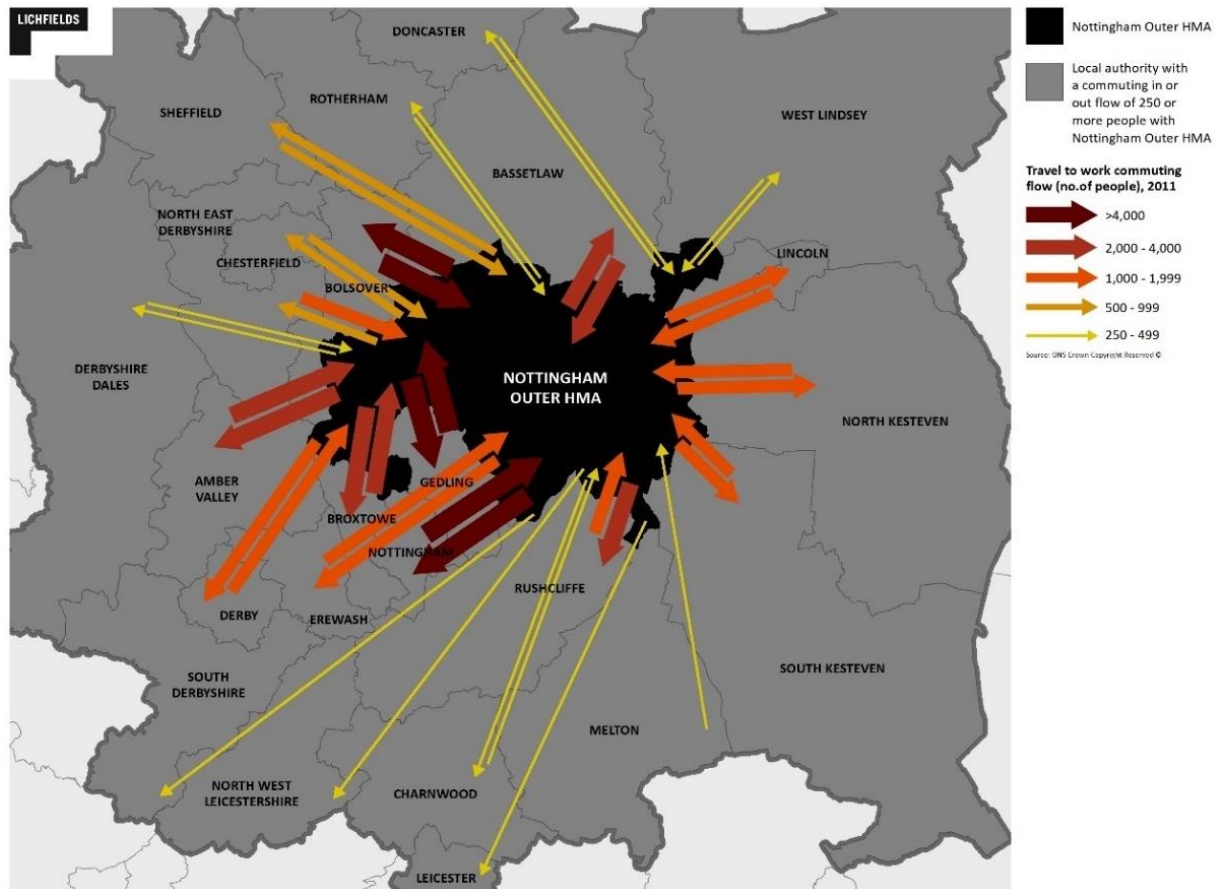

Source: ONS Census 2011 / Lichfields Analysis

- 4.19 Both the Core and Outer HMAs have subsequently been examined to see whether they would comprise a TTWA on the basis of the FEMA tests outlined previously, using the 2011 Census commuting data. The results have been presented in Table 4.1.
- 4.20 None of the districts in isolation could be said to be a TTWA in themselves. However, the 3 Outer HMA districts together do suggest that around 68% of local employed residents also work in the area, whilst the alternative test (based on the number of employed residents as a percentage of all jobs in the area) indicated a higher rate of 74%. The latter figure is only slightly below the 75% threshold and as such it forms a reasonable TTWA.
- 4.21 The Core HMA has figures even higher than this when considered as a self-contained TTWA. Table 4.1 indicates that the FEMA test ranges from 80.1% to 80.9% depending upon which indicator is tested. There is, therefore, a strong argument that the Core HMA forms a strong TTWA, and as such a FEMA. This has been driven by the considerable economic draw of Nottingham City.

Table 4.1 2011 Commuting Data

	Live and work in LA*	Resident workforce population	Workplace Population	Net flow	FEMA Test (live and work in same area: % resident workforce)	FEMA Test (live and work in the same area: % workplace population)
Ashfield	27,478	55,484	53,263	-2,221	49.5%	51.6%
<i>of which Hucknall comprises</i>	5,250	15,527	9,858	-5,669	33.8%	53.3%
Mansfield	25,270	48,561	41,190	-7,371	52.0%	61.3%
Newark and Sherwood	33,937	54,899	51,277	-3,622	61.8%	66.2%
OUTER HMA	107,707	158,944	145,730	-13,214	67.8%	73.9%
OUTER HMA excluding Hucknall	96,525	143,396	135,872	-7,524	67.3%	71.0%
Broxtowe	20,004	53,367	39,012	-14,355	37.5%	51.3%
Erewash	26,576	55,112	43,203	-11,909	48.2%	61.5%
Gedling	21,725	55,929	37,164	018,765	38.8%	58.5%
Nottingham City	85,202	123,743	174,936	51,193	68.9%	48.7%
Rushcliffe	25,324	55,665	46,256	-9,409	45.5%	54.7%
CORE HMA	275,554	343,816	340,571	-3,245	80.1%	80.9%
CORE HMA including Hucknall	290,311	359,364	350,429	-8,935	80.8%	82.8%

Source: 2011 Census / Lichfields Analysis

* Includes residents who live and work in the same LA; plus homeworkers, plus those who state they have no fixed workplace.

Hucknall

4.22 As mentioned above, the town of Hucknall is located within the District of Ashfield and lies 7 km to the North West of Nottingham City Centre. However, the town is often considered to be part of the Greater Nottingham conurbation, due to its location and subsequent strong linkages to the Nottingham City. In this context, it is instructive to examine commuting patterns of employed residents in Hucknall.

- 4.23 There is a total of 15,548 residents in Hucknall who are in employment. Of these:
- 5,250 live and work in the four MSOAs that broadly correlate to Hucknall's boundaries;
 - 1,234 commute elsewhere in Ashfield District;
 - 4,647 commute into Nottingham City for work;
 - 6,763 commute to the 5 Core HMA authorities (including Nottingham City); and,
 - Just 1,888 commute elsewhere in the Outer HMA (1,234 elsewhere in Ashfield, 422 to Mansfield and just 232 to Newark and Sherwood).

4.24 These flows are demonstrated in Figure 4.4, taken from the Figure in the 2015 ELFS. This shows particularly significant commuter flows into Nottingham, Gedling and Broxtowe from Hucknall.

Figure 4.4 Commuting patterns in Hucknall

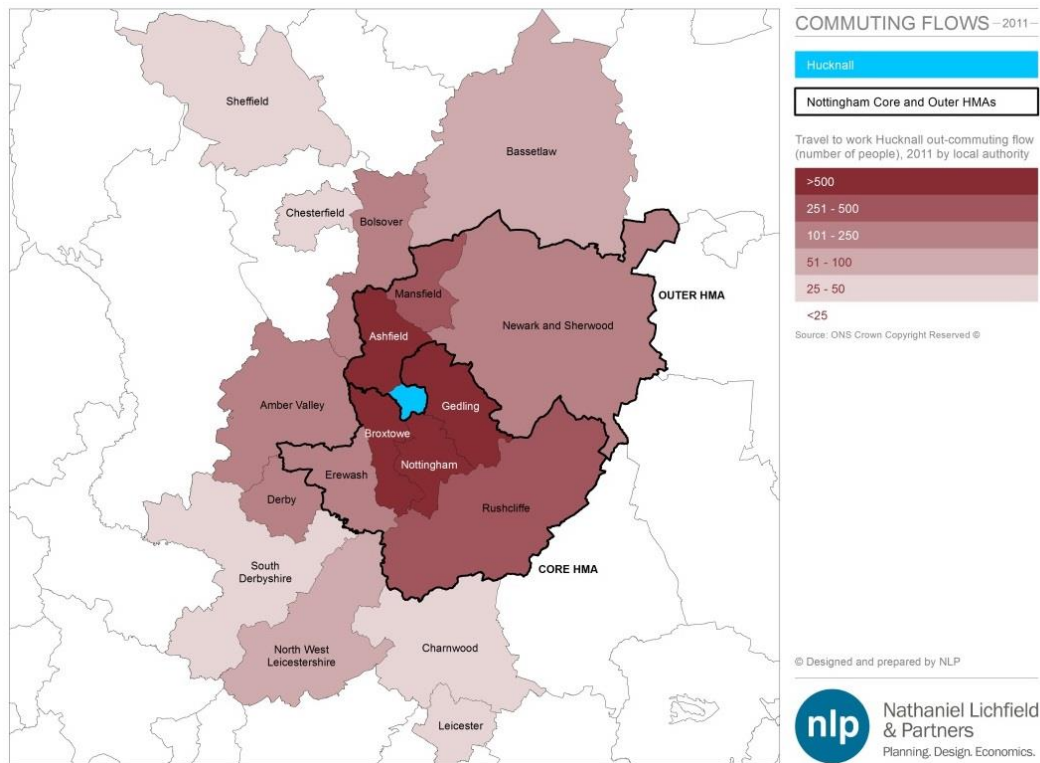

Source: MSOA commuting data from the Census, 2011 / Lichfields analysis

- 4.25 Table 4.1 indicates that the implications of including Hucknall in the Core HMA on the FEMA retention tests are unsurprising. The TTWA retention rates for the Core HMA increase from 80.1% to 80.8% using the first FEMA indicator, and from 80.9% to 82.9% using the second, when it is included alongside the five districts.
- 4.26 However, it is worth noting that the overall FEMA tests decline slightly for the Outer HMA if Hucknall is excluded. This reflects its relationship with the rest of Ashfield District and the high number of jobs in Hucknall that are taken up by its own residents.
- 4.27 As the data remains unchanged from that which was available for the 2015 ELFS our position also remains unchanged, namely that Hucknall has stronger linkages with the Core HMA districts, and particularly Nottingham City, than it does with the rest of Ashfield and certainly the other two Outer HMA districts of Mansfield and Newark and Sherwood. As such, it is considered that it would be more appropriate to consider it as being located within the Nottingham Core FEMA.

Housing Market Areas

Nottingham Core HMA

- 4.28 Opinion Research Services [ORS] was commissioned by the Nottingham Core HMA, comprising Broxtowe, Gedling, Erewash, Nottingham City and Rushcliffe to undertake a study to confirm the Nottingham Core Housing Market Area

[HMA] boundary in 2018³⁸. The purpose of the study was to confirm the boundary of the Nottingham Core HMA and Functional Economic Market Area [FEMA] based on Council boundaries.

4.29 Based on the range of analysis that ORS considered, it was evident that the geography of housing market areas around Nottingham is complex. The report found that there were clearly important functional relationships with areas such as Ashfield and Mansfield to the north, so it was relevant to note that PPG recognises that “*it might be the case that housing market areas overlap*” (paragraph 10). The three national mapped sources (NHPAU/CURDS Study, ONS TTWAs, VOA BRMAs) used in defining HMAs, all indicate that the Nottingham Core local authorities are all in the same HMA.

4.30 The report concluded that there is no single correct definition of an HMA and FEMA, but the CURDS HMA analysis, ONS Travel to Work Areas and BRMAs all indicated that **the Nottingham Core HMA authorities of Broxtowe, Gedling, Erewash, Nottingham City and Rushcliffe are all located within the same HMA and FEMA. The migration and commuting data also supported a Nottingham Outer HMA and FEMA containing Ashfield, Mansfield and Newark and Sherwood.**

“This does not prevent overlaps occurring between the area, with for example the town of Hucknall being in the administrative area of Ashfield, but within the functional HMA and FEMA for Nottingham Core HMA, while areas of Broxtowe, Erewash, Gedling, and Rushcliffe lie inside of other functional HMAs and FEMAs. However, from an administrative and practical point of view it is necessary for HMAs and FEMAs to follow local authority boundaries and the five authorities in the Nottingham Core HMA and FEMA remain the most appropriate grouping.” [paragraph 2.41]

Nottingham Outer HMA

4.31 The Nottingham Outer 2015 Strategic Housing Market Assessment [SHMA] (2015) produced a top-down analysis of housing market areas in the sub-region focusing on the major settlements and employment centres in the sub-region. The 2015 SHMA reviewed both the catchments of the major centres in and around Nottinghamshire, as well as the major commuting and migration flows within and beyond the sub-region.

4.32 The SHMA drew the following conclusions on the extent of the Outer Nottingham HMA³⁹:

- In Nottinghamshire, both migration and commuting data suggests links between the Nottingham Outer authorities. This is consistent with how market areas have previously been defined. The house price data also suggests strong links between Ashfield and Mansfield and the western parts of Newark and Sherwood;
- More widely there are also relationships with Bolsover and in particular the City of Nottingham. However, these links are largely localised and would not

³⁸ Opinion Research Services [ORS] (August 2018): Nottingham Core HMA Study 2018 – Report of Findings

³⁹ GL Hearn (October 2015): Nottingham Outer 2015 Strategic Housing Market Assessment, page 43

justify the Nottingham Outer local authorities being placed in the same HMA. Furthermore, although this reflects the reality of spatial relationships, for pragmatic reasons we would recommend that HMAs are drawn on the basis of local authority boundaries. This approach is supported by the PAS Technical Advice Note and also recognises that key demographic data on migration and official population and household projections are not published below local authority level.

- **In view of all the current and historic evidence as well as the existing ties, Ashfield, Mansfield and Newark and Sherwood comprise a single housing market area. This is a practical solution, but also one based on the balance of evidence presented.**
- However, it is important to recognise that in reality the market areas are not defined by hard and fast boundaries and in areas close to the defined boundaries, there are relationships and interactions in several directions. Similarly reflecting the geography of markets on the ground, significant housing development in a settlement may influence surrounding areas. However, for strategic planning purposes, GL Hearn identified a single HMAs based on a 'best fit' to local authority boundaries as a practical solution to support analysis and policy development.

Digital connectivity

- 4.33 The Nottingham Core-Outer HMA has relatively good digital connectivity as much of the sub region has access to at least superfast broadband (see Figure 4.5). According to data provided by Ofcom, with the exception of Newark & Sherwood and Gedling, the sub-region has greater connectivity when compared with the surrounding areas.
- 4.34 The Core-Outer HMA's good access to superfast broadband indicates that businesses and residents can easily connect to the wider world and that digital economic linkages likely extend well beyond the HMA's boundary.

Figure 4.5 Nottingham Core-Outer HMA Broadband Connectivity

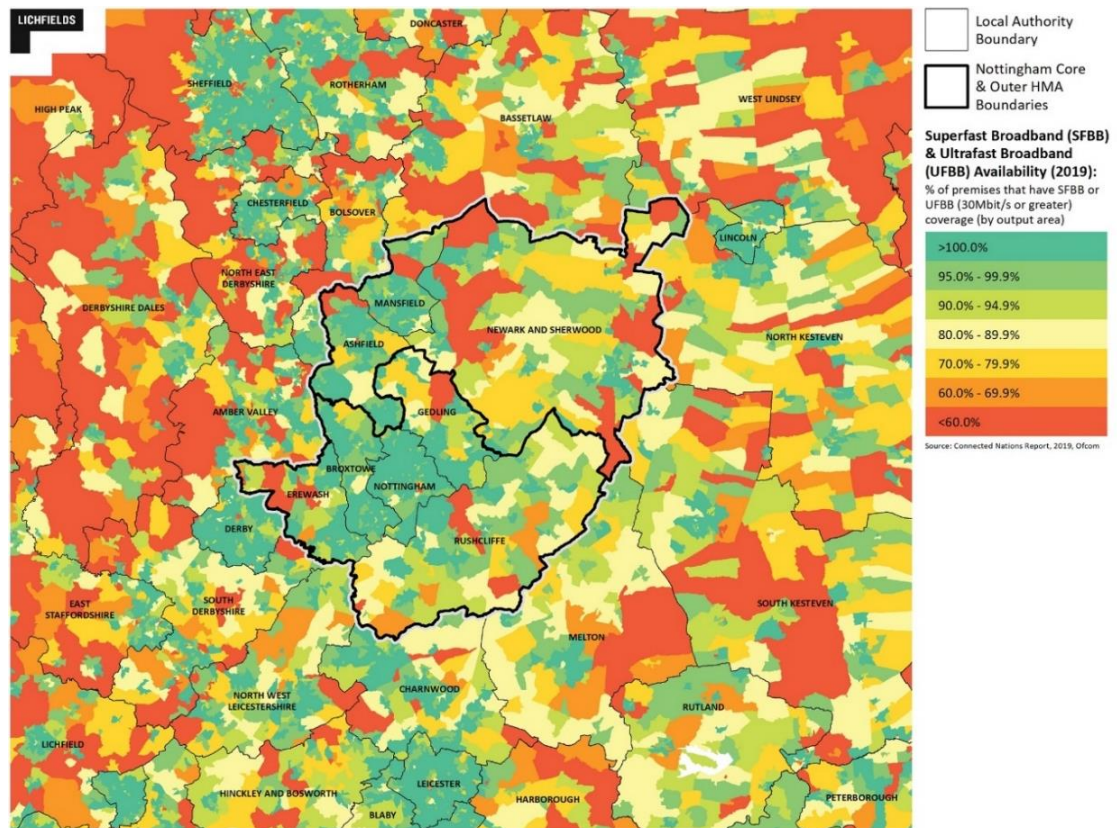

Source: Ofcom (2019): Connected Nations Report / Lichfields Analysis

Transport network

- 4:35 Transport networks support productivity and the success of local economies by facilitating the swift movement of goods and people and supporting business operations. Core-Outer HMA has excellent road links to a large proportion of the UK. The M1 runs directly north/south through the western districts of the sub-region, which links to London in the south, and to Yorkshire in north; providing further linkages onto the M25 and A42/M42 to the south; M6, M69 to the west; and the M18, M62, M621 to the north. Derby, Grantham and Burton-upon-Trent are easily accessible via the A52, Chesterfield via the A61 and Lincoln via the A46. The A1 motorway also provides an important link through Newark and Sherwood connecting London to the south and Edinburgh to the north.
- 4:36 The Core-Outer HMA has multiple train stations: with Nottingham being the largest and busiest. The Midlands Mainline runs through the Core-Outer HMA and accommodates a variety of regular services to/from London St Pancras, Nottingham, Sheffield, Leicester, Derby and Chesterfield including East Midlands Railway, CrossCountry Trains, Thameslink and TransPennine Express.

Duty-to-Cooperate

- 4.37 The Localism Act 2011 sets out that the duty to co-operate applies to activities which can ‘reasonably be considered to prepare the way’ for a development plan or local development document. This is re-affirmed by the Framework, which sets out at paragraph 24 that Local Planning Authorities [LPAs] are under a duty to cooperate with each other, and with other prescribed bodies, on strategic matters that cross administrative boundaries, including through the preparation of Statements of Common Ground.
- 4.38 This ELNS recognises that neighbouring LPAs have pursued individual Local Plans, which currently have progressed at different stages. However, it is understood that neighbouring LPAs are currently committed to meeting their own employment land needs (see Section 2.0 for a detailed overview by district).
- 4.39 Furthermore, the methodological approach set out and adopted in this ELNS is underpinned by nationally consistent demographic and economic assumptions, which ensures a degree of consistency across the sub-region, in its approach for the determination of Employment Land Need and complements the neighbouring LPA’s ELRs therefore ensuring a clear picture of employment land need across the Core-Outer HMA and beyond.
- 4.40 Notwithstanding in accordance with the duty to co-operate, the requirements of the 2011 Localism Act and the Framework, the Councils will need to continue to ‘*engage constructively, actively and on an on-going basis*’ (Section 110:2 of the 2011 Localism Act) with their neighbouring authorities to ensure that strategic planning issues, in particular strategic distribution employment land needs, are met.

Conclusion on the extent of the FEMAs

- 4.41 On balance, it is considered that the Core HMA forms a self-contained FEMA. Despite the FEMA tests indicating a slightly less conclusive result once applied to three Outer HMA districts, an argument can be made that the Outer HMA is also a self-contained FEMA. With regards to Hucknall, as with the previous 2015 ELFS, this study considers that, whilst it is within the administrative boundaries of Ashfield/Outer HMA, Hucknall is highly connected to the Core HMA and could be viewed as being located within that FEMA.

5.0 **Commercial Property Market Signals and Intelligence**

Introduction

5.1 This section initially provides an overview of the current stock of employment space across the Nottingham Core and Outer HMAs, while also summarising recent trends and changes to the supply of this employment space. The amount of employment land and floorspace has been considered across the three main types of employment uses (i.e. office, manufacturing and warehouse and distribution).

5.2 The section then provides an overview of the property market from a national and local perspective. It examines the key office and industrial employment locations across the study area and provides a view on rents and land values. This has been informed by a review of market trends and secondary data, as well as consultations with a number of stakeholders such as commercial agents and developers active in the area.

5.3 This analysis uses data from the following sources:

- 1 Commercial floorspace data from the ONS and various datasets from the Valuation Office Agency [VOA];
- 2 Monitoring data on commercial space from each Council;
- 3 EGi Property Link database and other commercial property sources;
- 4 The results of a business survey sent to all contacts on the Council's databases in December 2020 – January 2021 and,
- 5 Discussions with a number of local agents and other commercial stakeholders and the findings of the stakeholder workshop, held in December 2020 and January 2021.

Employment Space

Floorspace Trends

5.4 Based on Valuation Office Agency [VOA] data⁴⁰, Figure 3.12 highlights the change in commercial floorspace for the districts within the Nottingham Core and Outer HMA between 2000/01 and 2019/20. Overall, the Core HMA's total stock of employment space decreased substantially from 6,131,000 sqm to 5,147,000 between 2000/01 to 2019/12 – a decrease of 16%. This contrasts with the steady 8.9% growth that has been experienced by the East Midlands region and the minor decrease (-0.6%) seen in England as a whole. The Outer HMA on the other hand, has experienced an increase of its total stock of employment space from 2,381,000 sqm to 2,981,000 sqm – an increase of 25.2%, which is well above the regional and national figures.

5.5 The Core HMA overall decrease in stock of employment space has been driven by a considerable decrease in industrial floorspace by 1,010,000 sqm over the

⁴⁰ VOA (2020) Business /Industrial Floorspace by administrative area

data period; this represents a decrease of nearly 20%. This contrasts with the industrial floorspace figures for the Outer HMA, which have experienced an increase from 2,196,000 sqm to 2,686,000 sqm between 2000/01 and 2019/20 – an increase of 22.3%. This growth has compounded with the strong growth in the Outer HMA’s office space stock, from 185,000 sqm to 295,000 sqm – an increase of 59.5%. The Core HMA also saw an increase in its stock of office floorspace, albeit at a smaller level, of 2.6% from 996,000 sqm to 1,022,000 sqm between 2000/01 to 2019/20.

Figure 5.1 Change in Nottingham Core-Outer HMA Commercial Floorspace 2000/01-2019/20

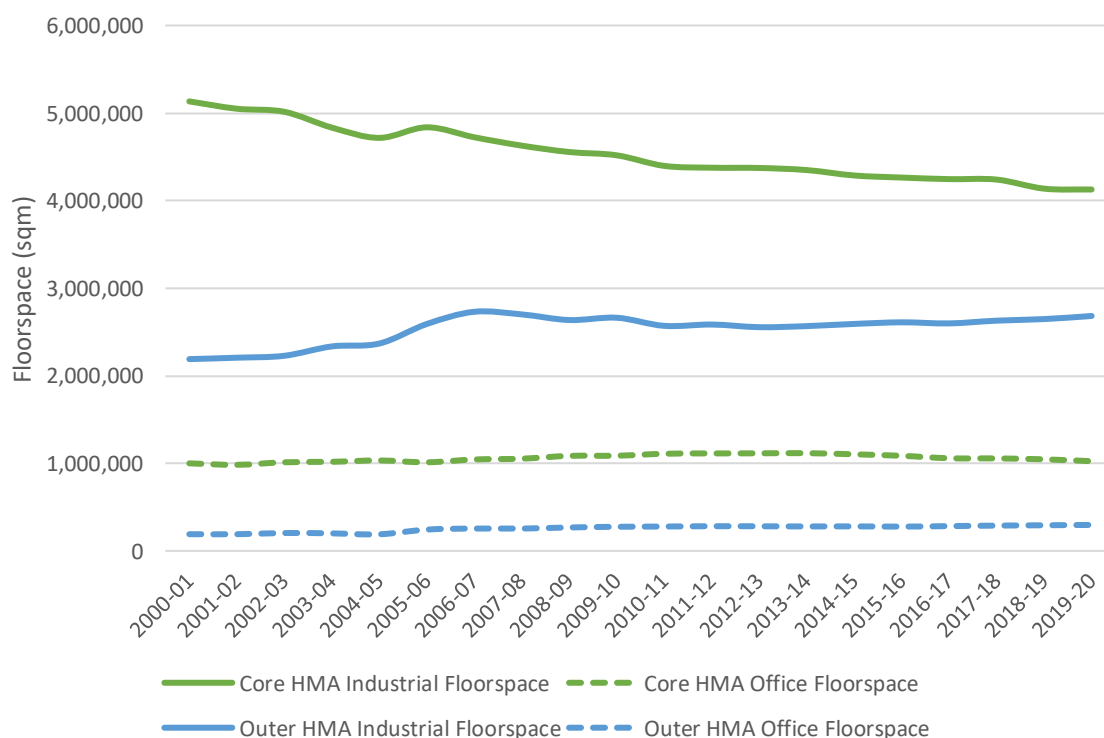

Source: VOA (2020): Total Commercial floorspace by administrative area, date to 31 March 2019

5.6 In terms of office space provision within the Outer HMA, Ashfield saw the biggest increase since 2000/01 at a rate of 215%, gaining 73,000 sqm (Table 5.1). Increases in office space are positive but much lower in Newark & Sherwood and Mansfield at 36% and 15% respectively. Both Ashfield and Newark & Sherwood experienced similar increases in industrial floorspace of 28% (+268,000 sqm) and 23% (+164,000) respectively, compared to an increase of 11% (+58,000 sqm) in Mansfield.

5.7 In the Core HMA, Broxtowe has increased its office floorspace since 2000/01 by 59%, albeit from a relatively small base. Erewash has seen office space growth of 54% (+21,000 sqm); Rushcliffe lower proportional growth of 26% (+25,000 sqm); and Nottingham City a decline of 4% (-27,000) (albeit starting from a much higher base). Gedling is the only other Core HMA authority to have experienced a decline in office space at a significant -29% (-19,000 sqm). Regarding industrial floorspace, Rushcliffe is the only Core HMA authority to have seen significant growth with an increase of 39.0% (+128,000 sqm), whilst Gedling saw only modest growth of 6% (+25,000 sqm). The amount of

industrial space has declined very significantly in Nottingham City (-33% / -925,000 sqm), with falls also seen in Broxtowe (-25% / -134,000 sqm) and Erewash (-10% / -104,000 sqm).

Table 5.1 Employment Floorspace (2001-2020)

	Offices			Industrial		
	Floorspace (sqm) (2020)	Absolute Change (2001-2020)	% Change (2001-2020)	Floorspace (sqm) (2020)	Absolute Change (2001-2020)	% Change (2001-2020)
Ashfield	107,000	73,000	214.7%	1,234,000	268,000	27.7%
Mansfield	94,000	12,000	14.6%	585,000	58,000	11.0%
Newark and Sherwood	94,000	25,000	36.2%	867,000	164,000	23.3%
Outer HMA	295,000	110,000	59.5%	2,686,000	490,000	22.3%
Nottingham	725,000	-27,000	-3.6%	1,842,000	-925,000	-33.4%
Broxtowe	70,000	26,000	59.1%	404,000	-134,000	-24.9%
Gedling	47,000	-19,000	-28.8%	465,000	25,000	5.7%
Rushcliffe	120,000	25,000	26.3%	460,000	128,000	38.6%
Erewash	60,000	21,000	53.8%	954,000	-104,000	-9.8%
Core HMA	1,022,000	26,000	2.6%	4,125,000	-1,010,000	-19.7%

Source: VOA (2020) / Lichfields analysis

Age of Industrial/Commercial Premises

- 5.8 Table 5.2 compares the age of premises in the Nottingham Core and Outer HMA with the corresponding data for the East Midlands and England as a whole.
- 5.9 From this it can be seen that over half of all B-class units in the Nottingham Core (67.1%) and Outer (58.6%) HMA were built before 1970. The Core HMA stock of space comprises a higher proportion of older premises to the East Midlands (61.3% of units built prior to 1970) and England and Wales (63.8%), whilst the Outer HMA has a reduced proportion in relation to the comparators.
- 5.10 As can be seen from the tables, Nottingham Core HMA has a relatively high volume of commercial units constructed before WWII, with 59.5% of offices, 39.6% of factories and 37.6% of industrial units dating from before 1940, a rate that is higher than both the East Midlands and England & Wales averages. This would suggest that the historic rate of commercial floorspace replacement has been lower in the Core HMA than in the comparator areas.
- 5.11 The Nottingham Outer HMA has a lower level of commercial units built before 1970 than the rest of the East Midlands and England and Wales. This includes just 48% of factory units being built pre-1970, which suggests a high level of replacement for factory floorspace in these districts. However, the data on the age of stock is only provided up to 2004 and therefore it does not provide an indication of more recent floorspace replacement trends.

Table 5.2 Total number of units by Age for each bulk class

	Use Class	Unknown Age	Pre 1940	1940-70	1971-80	1981-90	1991-2000	2001-03	All ages (excluding unknown)
Nottingham Core HMA	Office	59	2,134	651	126	322	276	77	3,586
	Factory	12	1,537	864	340	677	410	51	3,879
	Warehouse	26	976	592	309	435	255	31	2,598
	Total	97	4,647	2,107	775	1,434	941	159	10,063
Nottingham Outer HMA	Office	7	688	227	66	88	96	69	1,234
	Factory	7	469	414	229	309	312	108	1,841
	Warehouse	18	312	283	114	149	125	29	1,012
	Total	32	1,469	924	409	546	533	206	4,087

Source: DCLG (2004): Age of commercial and industrial stock: local authority level 2004 (Table 3.1)

Table 5.3 Proportion of units built up to 1970

		Pre-1940 floorspace	Floorspace built 1940-1970	Total Floorspace Pre-1970
Nottingham Core HMA	Office	59.5%	18.2%	77.7%
	Factory	39.6%	22.3%	61.89
	Warehouse	37.6%	22.8%	60.4%
	Total B Class	46.2%	20.9%	67.1%
Nottingham Outer HMA	Office	55.8%	18.4%	74.2%
	Factory	25.5%	22.5%	48.0%
	Warehouse	30.8%	28.0%	58.8%
	Total B Class	36.0%	22.6%	58.6%
East Midlands	Office	56.2%	14.6%	67.7%
	Factory	33.4%	23.9%	57.3%
	Warehouse	31.85%	24.53%	56.4%
	Total B Class	40.10%	21.15%	61.3%
England and Wales	Office	51.0%	18.3%	69.2%
	Factory	32.7%	28.2%	60.9%
	Warehouse	32.1%	26.7%	58.8%
	Total B Class	40.0%	23.8%	63.8%

Source: DCLG (2004): Age of commercial and industrial stock: local authority level 2004 (Table 3.1) / Lichfields Analysis

Table 5.4 Proportion of units built up to 1970 – Nottingham Core / Outer HMA

		Pre-1940 floorspace	Floorspace built 1940-1970	Total Floorspace Pre-1970
Broxtowe	Office	42.6%	21.3%	63.9%
	Factory	35.7%	29.8%	65.5%
	Warehouse	33.5%	31.7%	65.1%
	Total B Class	37.5%	27.3%	64.8%
Erewash	Office	68.4%	11.9%	80.3%
	Factory	39.9%	17.3%	57.2%
	Warehouse	38.6%	15.0%	53.5%
	Total B Class	45.4%	15.6%	61.0%
Gedling	Office	49.7%	30.7%	80.4%
	Factory	30.8%	32.6%	63.4%
	Warehouse	34.5%	35.0%	69.4%
	Total B Class	38.5%	32.4%	70.9%
Nottingham City	Office	62.7%	17.0%	79.7%
	Factory	41.9%	19.8%	61.6%
	Warehouse	39.3%	21.7%	61.0%
	Total B Class	49.3%	19.2%	68.5%
Rushcliffe	Office	59.9%	15.9%	75.9%
	Factory	41.5%	27.5%	69.1%
	Warehouse	33.9%	22.1%	56.1%
	Total B Class	47.1%	21.3%	68.4%
Ashfield	Office	42.9%	23.4%	66.3%
	Factory	25.8%	17.3%	43.1%
	Warehouse	32.2%	20.1%	52.2%
	Total B Class	31.1%	19.3%	50.4%
Mansfield	Office	50.4%	18.9%	69.3%
	Factory	24.9%	24.1%	48.9%
	Warehouse	29.3%	33.3%	62.7%
	Total B Class	35.2%	24.6%	59.8%
Newark & Sherwood	Office	67.4%	15.4%	82.8%
	Factory	25.7%	26.1%	51.7%
	Warehouse	31.1%	30.4%	61.5%
	Total B Class	40.6%	23.5%	64.1%

Source: DCLG (2004): Age of commercial and industrial stock: local authority level 2004 (Table 3.1) / Lichfields Analysis

Business Demography and Enterprise

Broxtowe

5.12

Broxtowe Borough's business base is dominated by smaller firms comprising 0 to 9 employees (89.3% of enterprises). This is slightly above the regional (88.1%) and national (88.8%) averages. The proportion of large enterprises with over 250 staff in Broxtowe is relatively high (0.8%), being above the regional (0.4%) and national (0.4%) averages and the same level as Nottingham City^[1].

^[1] ONS, UK Business Counts (2020)

- 5.13 The total number of active enterprises in the Borough (3,275) indicates that there are 457 active enterprises per 10,000 working age residents. This is lower than the comparable rates for the East Midlands (604) and England and Wales (663). Between 2010 and 2020, the number of active enterprises in the Borough increased by 525, or 19.1%. This is again significantly lower than the regional (28.48%) or national (32.3%) averages.
- 5.14 Employment in Broxtowe is centred around the four main settlements of Beeston, Stapleford, Kimberly and Eastwood. Beeston is the predominant business location, with a high number of enterprises in the public services, IT, science, technical, and construction sectors. There is a cluster of large manufacturing and transport/storage businesses to the east of Beeston crossing over towards the Nottingham EZ, with many smaller firms dotted throughout the centre emerging into another cluster to the south west towards Toton. Whilst there is a smaller business presence overall, there are some large manufacturing and transportation / storage firms within business parks on the outskirts of both Kimberly and Eastwood close to the A610, including the Amazon Facility on the border with Amber Valley Borough.

Figure 5.2 Broxtowe Employment by Sector

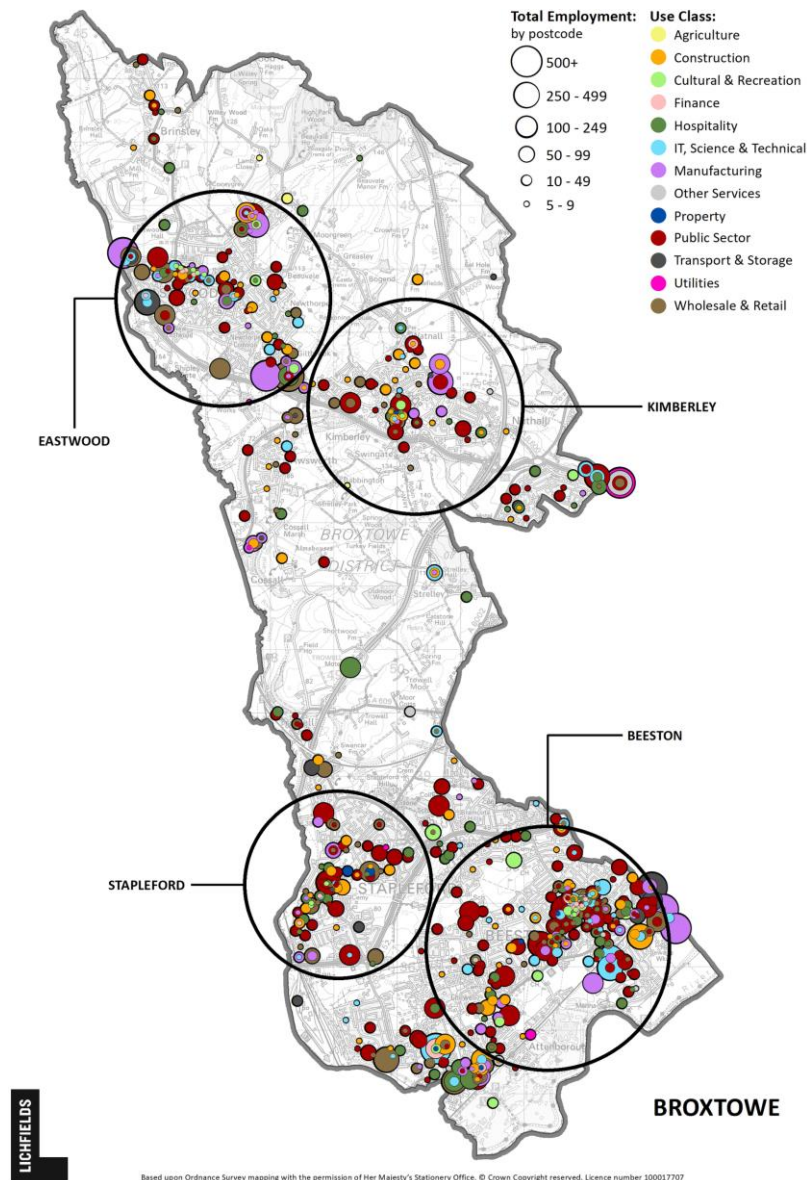

Erewash

5.15

An assessment of the size of businesses shows that the Borough’s business base is dominated by smaller firms comprising 0 to 9 employees (87.1% of enterprises). This is comparable to the regional (88.1%) and national (88.8%) averages. The proportion of large enterprises with over 250 staff in Erewash is low (0.4%), although it is comparable with the regional (0.4%) and national (0.4%) average⁴¹. The total number of active enterprises in the Borough (3,730) indicates that there are 516 active enterprises per 10,000 working age residents. This is lower than the rates for the East Midlands (604) and England and Wales (663).⁴²

⁴¹ ONS, UK Business Counts (2020)

⁴² Ibid

Figure 5.3 Erewash Employment by Sector

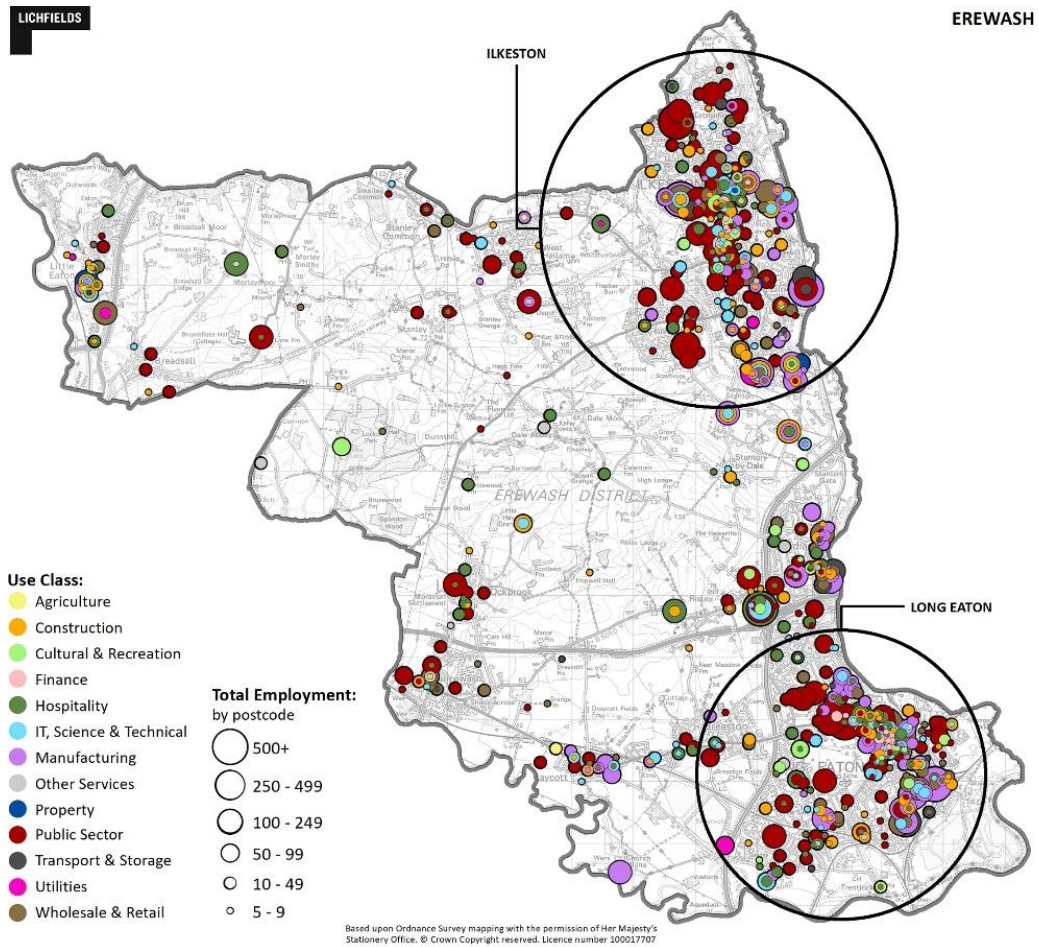

Source: ONS (2020): Inter-Departmental Business Register (2020)

5.16 Between 2010 and 2020, the number of active enterprises in the Borough increased by 495, or 15.3%. This is the lowest growth rate within the Core HMA and is significantly lower than the regional (28.48%) or national (32.3%) average.⁴³

5.17 The primary business areas in the Borough are Ilkeston and Long Eaton, as well as along the M1 between these two areas. There are smaller clusters of activity in Little Eaton and along the A52 from Long Eaton to Borrowwash. Along the M1 and into Ilkeston the most prominent business sectors are public sector (including health, education and social work) as well as a significant presence of manufacturing; transport and storage; and wholesale and retail businesses. There are also clusters of smaller construction and IT, Science and Technical businesses towards the centres of both settlements along the M1.

Gedling

5.18 Gedling Borough’s business base is dominated by smaller firms comprising 0 to 9 employees (90.9% of enterprises). This is slightly higher than the regional (88.1%) and national (88.8%) averages. The proportion of large enterprises

⁴³ Ibid

with over 250 staff in Gedling is low (0.3%), although it is similar to the regional (0.4%) and national (0.4%) average⁴⁴. The total number of active enterprises in the Borough (3,525) indicates that there are 481 active enterprises per 10,000 working age residents. This is lower than the rates for the East Midlands (604) and England and Wales (663).⁴⁵

Figure 5.4 Gedling Employment by Sector

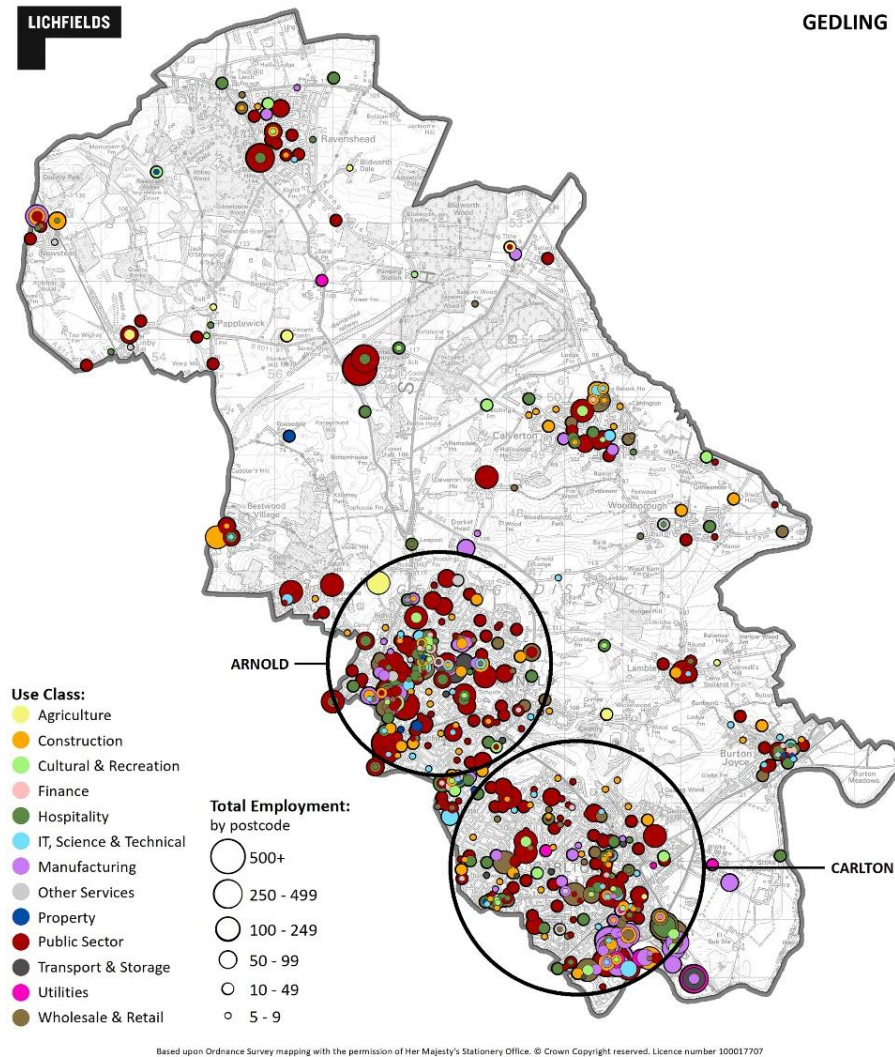

Based upon Ordnance Survey mapping with the permission of Her Majesty's Stationary Office. © Crown Copyright reserved. Licence number 100017707

Source: ONS (2020): Inter-Departmental Business Register (2020)

- 5.19 Between 2010 and 2020, the number of active enterprises in the Borough increased by 585, or 19.9%. This is the 3rd strongest growth in the Core HMA behind Rushcliffe and Nottingham; and is significantly lower than the regional (28.48%) or national (32.3%) average.⁴⁶
- 5.20 The predominant business clusters within the Borough are in the towns of Arnold and Carlton, along with smaller clusters in Burton Joyce, Calverton and Ravenshead. Whilst there does not look to be a significant presence of transport

⁴⁴ ONS, UK Business Counts (2020)

⁴⁵ Ibid

⁴⁶ Ibid

and storage businesses within Gedling, there is a significant manufacturing cluster to the south of Carlton in and around the Carlton Industrial Estate and Victoria Business Park.

Nottingham City

5.21

Whilst Nottingham City’s business base is dominated by smaller firms comprising 0 to 9 employees (86.1% of enterprises), this is the lowest share of micro businesses within the Core HMA and a lower share than the regional (88.1%) and national (88.8%) averages. The proportion of large enterprises with over 250 staff in Nottingham is relatively high at (0.8%) when compared to the regional (0.4%) and national (0.4%) averages⁴⁷.

Figure 5.5 Nottingham City Employment by Sector

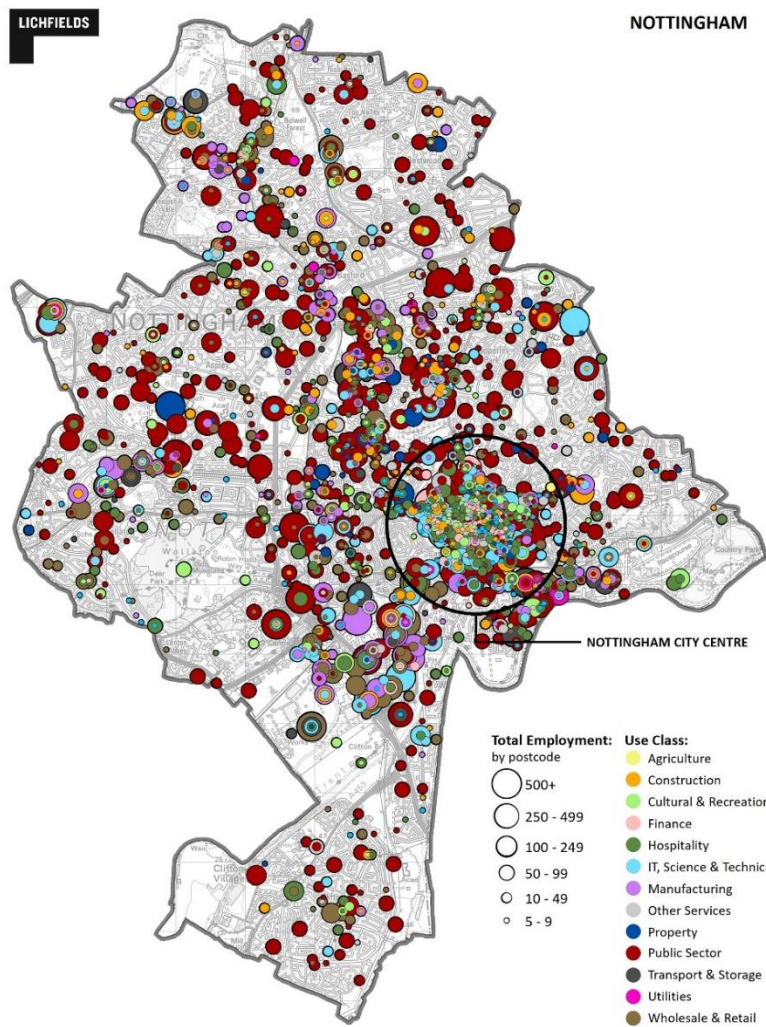

Source: ONS (2020): Inter-Departmental Business Register (2020)

5.22

The total number of active enterprises in the City (9,305) indicates that there are 397 active enterprises per 10,000 working age residents. This is lower than the rates for the East Midlands (604) and England and Wales (663).⁴⁸

⁴⁷ ONS, UK Business Counts (2020)

⁴⁸ Ibid

5.23 Between 2010 and 2020, the number of active enterprises in the City increased by 2,510, or 36.9%. This is the strongest growth in the Core HMA; and is above the regional (28.48%) and national (32.3%) average.⁴⁹

5.24 Typical of any City, Nottingham has a large cluster of small businesses at its centre, featuring predominantly hospitality and cultural/leisure businesses alongside office-based sectors such as finance, property and IT, technical and professional services. The city also has a large presence of public services spread throughout. There is a notable cluster of larger predominantly manufacturing and wholesale/retail businesses to the south-west of the centre in and around the Queens Drive Industrial Estate, Lenton Industrial Estate and Riverside Retail Park. Other clusters are visible along Glaisdale Parkway to the east; and Basford and Bullwell to the north-west of the centre.

Rushcliffe

5.25 Rushcliffe Borough has the largest share of micro firms in the sub-region, comprising 0 to 9 employees within the Core HMA (91.4% of enterprises). This is higher than the regional (88.1%) and national (88.8%) averages. In contrast, the Borough has the smallest shares of small (10-49 employees) and medium (50 -249 employees) in the Core HMA at 7.1% and 1.1% respectively. The proportion of large enterprises with over 250 staff in Rushcliffe is low (0.4%) but comparable to the regional (0.4%) and national (0.4%) average⁵⁰.

5.26 The total number of active enterprises in the Borough (5,405) indicates that there are 738 active enterprises per 10,000 working age residents. This is the highest ratio within the core HMA by some margin and higher than rates for the East Midlands (604) and England and Wales (663).⁵¹

5.27 Between 2010 and 2020, the number of active enterprises in the Borough increased by 1,190, or 28.2%; second within the core HMA behind Nottingham City and slightly below the regional (28.48%) and national (32.3%) average.⁵²

⁴⁹ Ibid

⁵⁰ ONS, UK Business Counts (2020)

⁵¹ Ibid

⁵² Ibid

Figure 5.6 Rushcliffe Employment by Sector

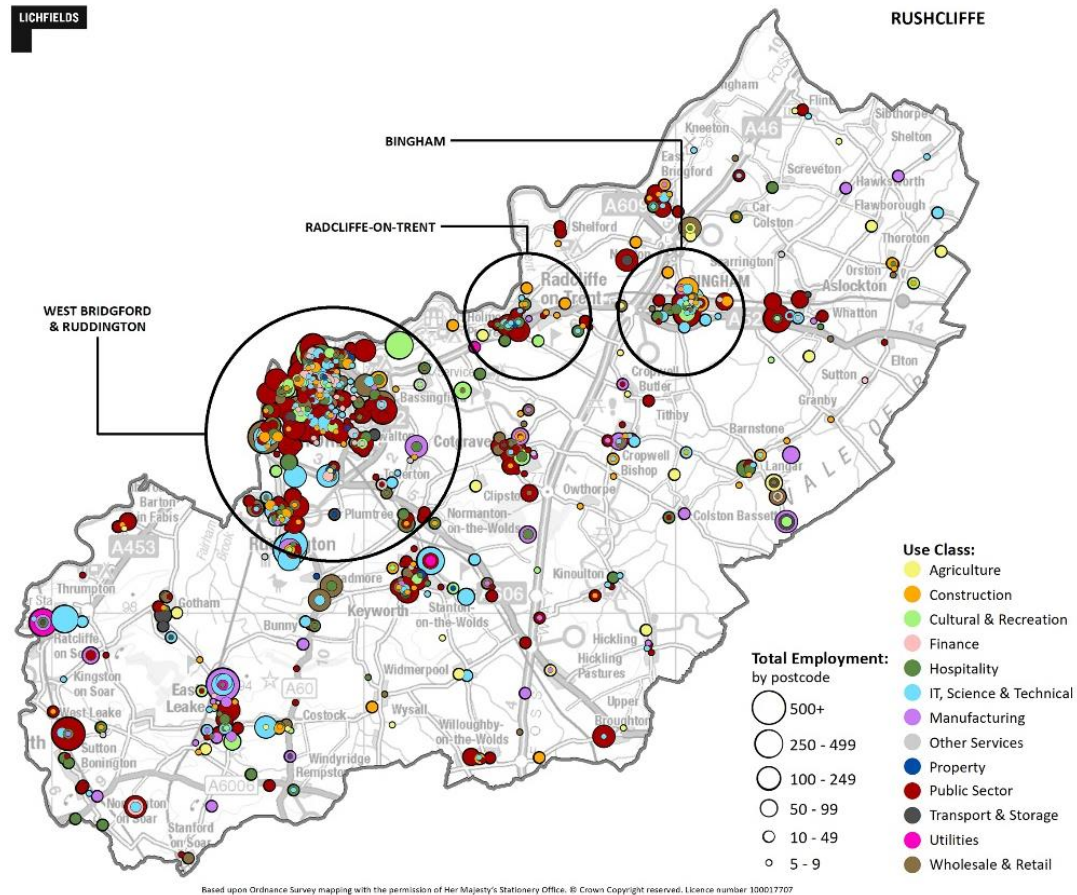

Source: ONS (2020): Inter-Departmental Business Register (2020)

Ashfield

5.28 An assessment of the size of businesses shows that the Ashfield’s business base is dominated by smaller firms comprising 0 to 9 employees (86.3% of enterprises). This is a slightly lower share than the regional (88.1%) and national (88.8%) averages. The proportion of large enterprises with over 250 staff in Ashfield is low (0.7%), although it has the highest share of large businesses in the Outer HMA and a larger share than the regional (0.4%) and national (0.4%) average⁵³.

5.29 The total number of active enterprises in the District (2,985) indicates that there are 372 active enterprises per 10,000 working age residents. This is the lowest ratio in the Outer HMA and is lower than the rates for the East Midlands (604) and England and Wales (663).⁵⁴

5.30 Between 2010 and 2020, the number of active enterprises in the District increased by 455, or 18.0%. This is significantly lower than the regional (28.48%) or national (32.3%) average.⁵⁵

⁵³ ONS, UK Business Counts (2020)

⁵⁴ Ibid

⁵⁵ Ibid

Figure 5.7 Ashfield Employment by Sector

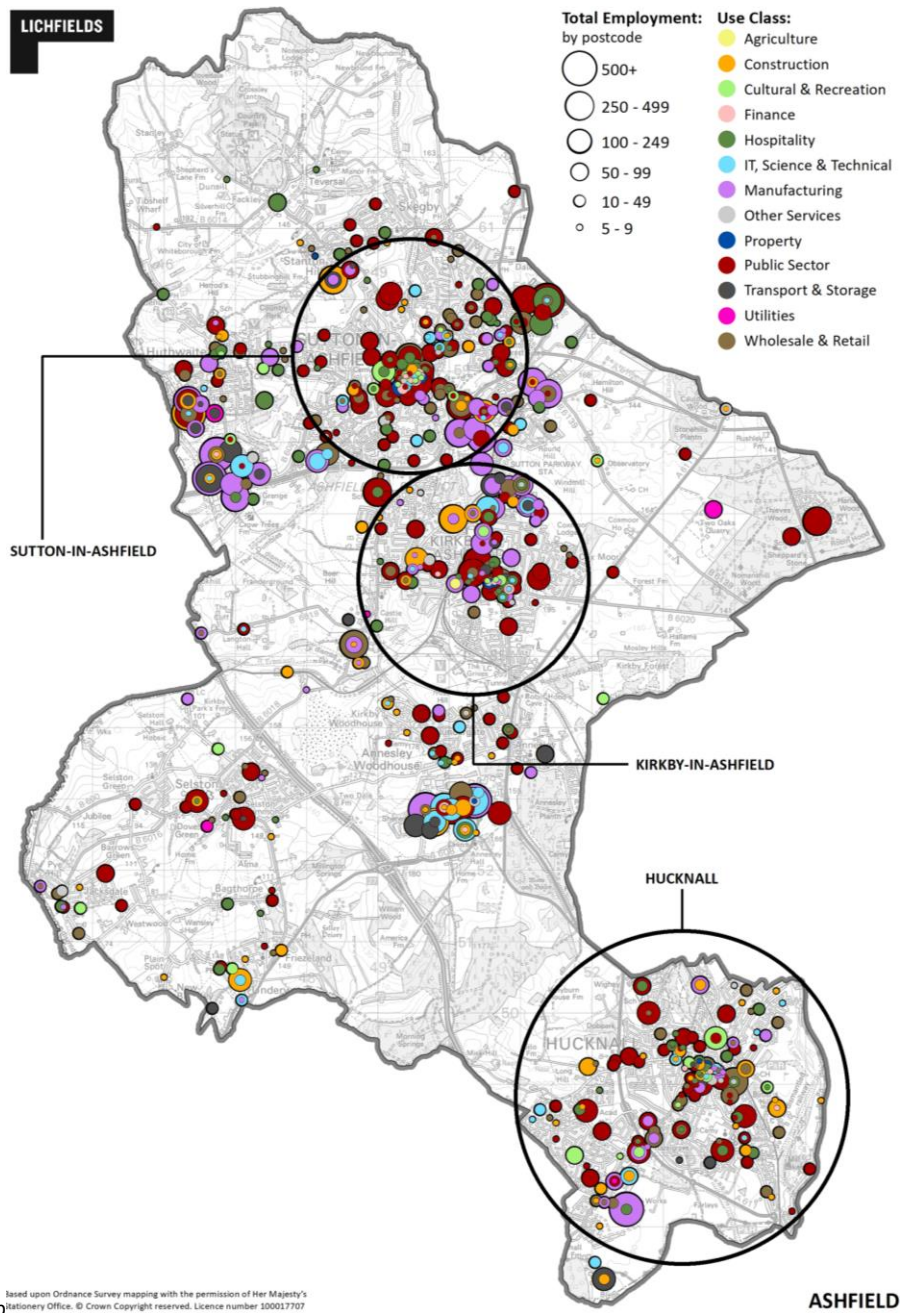

Source: ONS (2020): Inter-Departmental Business Register (2020)

5.31

The primary business clusters in the District are located in the centres of Sutton in Ashfield, Kirkby-in-Ashfield and Hucknall to the south of the District. There is a concentration of manufacturing, wholesale and retail, and transport and storage businesses to the south east of Sutton in Ashfield starting from the site recently taken by Amazon, and then running alongside the rail line southwards to Kirkby-in-Ashfield. There are a number of business and industrial parks in this area. There are also noticeable clusters within business parks and industrial estates to the west of Sutton in Ashfield and at the Sherwood Business park to the south of Kirkby-in-Ashfield. Further south there is also a high

HMA, albeit it is still slightly lower than the regional (28.48%) or national (32.3%) averages.⁵⁸

- 5.35 The majority of employment within Mansfield is located around Mansfield Town Centre, which has a high concentration of public service, IT, science and technical, and wholesale and retail employment. There are a number of clusters surrounding but somewhat separate to the town centre, including the Oakham Business Park on the border with Ashfield; at the Millennium Business Park and along Chesterfield Road running north west from the centre; around the Old Mill Lane Industrial Estate just north of the centre; and, around the Sherwood Oaks Business Park to the south east. There is also a small cluster of manufacturing employment around the Crown Farm Industrial Estate to the East.

Newark & Sherwood

- 5.36 Newark and Sherwood's business base has a high share of smaller firms comprising 0 to 9 employees (89.6% of enterprises). This is a slightly higher share than the regional (88.1%) and national (88.8%) averages. The proportion of large enterprises with over 250 staff in the District is the lowest of any areas assessed within this study (0.2%) and half the regional (0.4%) and national (0.4%) averages⁵⁹.

⁵⁸ Ibid

⁵⁹ ONS, UK Business Counts (2020)

Figure 5.9 Newark & Sherwood Employment by Sector

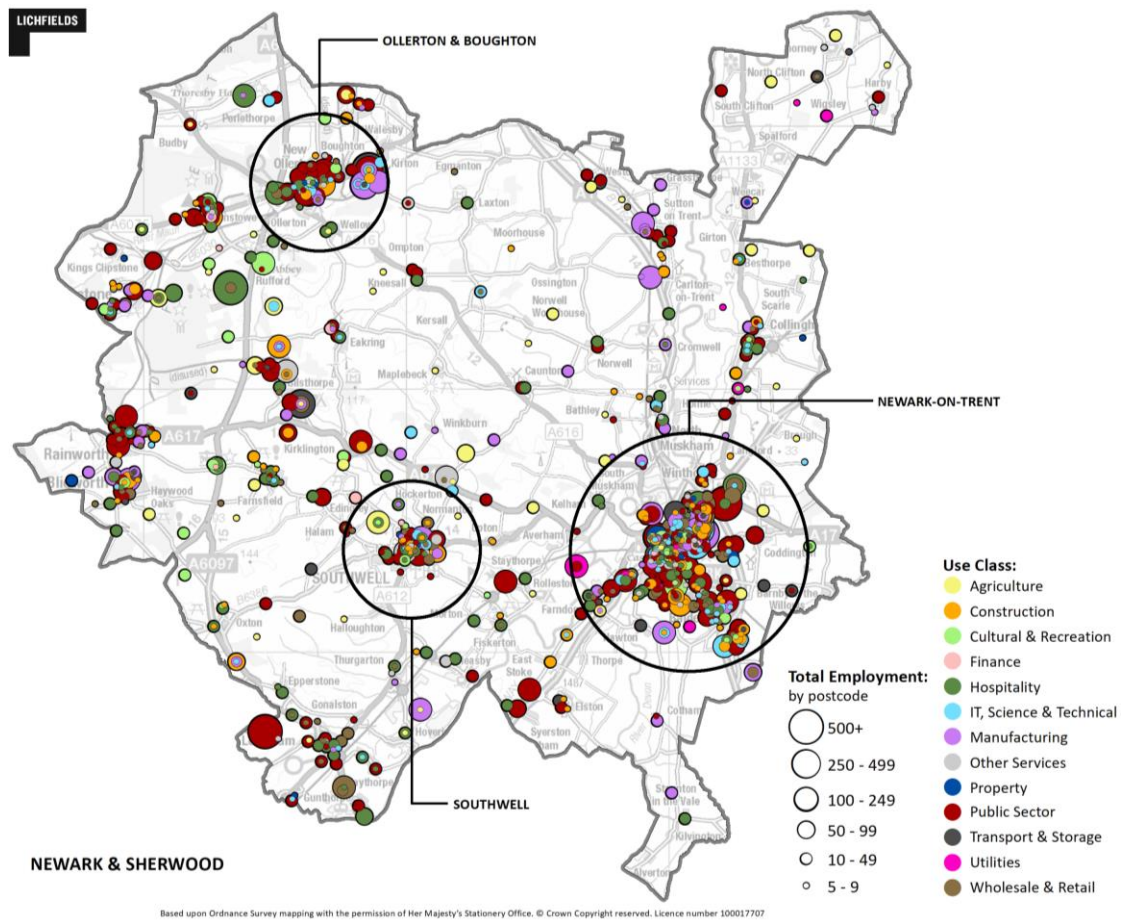

Source: ONS (2020): Inter-Departmental Business Register (2020)

- 5.37 The total number of active enterprises in the District (4,875) indicates that there are 651 active enterprises per 10,000 working age residents. This is the highest ratio within the Outer HMA by some margin; is higher than the rates for the East Midlands (604); and comparable to England and Wales (663).⁶⁰
- 5.38 Between 2010 and 2020, the number of active enterprises in the District increased by 695, or 16.6%. This is the lowest level of growth within the Outer HMA and significantly lower than the regional (28.48%) or national (32.3%) average.⁶¹
- 5.39 The District has a number of employment clusters as well as a large number of smaller employers distributed relatively evenly between these along east-west road connections such as the A617. The largest concentration of employment is at Newark-on-Trent centre, with smaller clusters at Southwell, Ollerton & Boughton, Rainworth and Lowdham. There are a number of larger manufacturing businesses along the A1 alongside a small cluster on the industrial estates to the east of Ollerton & Boughton. However, there is less employment in transport and storage businesses along these links than might be expected.

⁶⁰ Ibid
⁶¹ Ibid

Development Rates

Gross Completions

- 5.40 Data on past completions by office/industrial/warehousing sector was provided by each of the HMA boroughs, going back as far as data was robustly available. Concerns were expressed in the previous ELFS regarding the robustness of the data, particularly concerning losses as records did not generally go back as far as the completions data did, making ‘net’ calculations problematic. Lichfields also had concerns regarding the robustness of some of the data concerning losses of office space in Nottingham City, as the data seemed likely to be an under-estimate given that Nottingham reportedly had one of the highest rates of office-to-residential permitted development conversions in England.⁶²
- 5.41 Over the past 5 years, the Councils have begun reporting employment land completions / losses data on a more comprehensive scale and in a generally consistent manner, particularly across the five Nottingham Core HMA districts and greater weight can be attached to their likely accuracy as a consequence. That is not to say there are not some figures that look anomalous, and where these appear, we have qualified them as a consequence (as summarised in the VOA Business Rate sensitivity test below).
- 5.42 Table 5.5 indicates that across the Nottingham Core HMA, some 62,696 sqm of office (including R&D) floorspace has been developed over the past 9 years, of which almost 40% was delivered in Nottingham alone. Take up rates for office space were very ‘lumpy’ for Erewash and particularly Gedling, where very little office floorspace has actually come forward in recent years. Broxtowe experienced comparatively high levels of take up, particularly for the most recent recording year.

Table 5.5 Gross Annual Office Floorspace Completion Rates in Core HMA, (sqm)⁶³

	2011/12	2012/13	2013/14	2014/15	2015/16	2016/17	2017/18	2018/19	2019/20	TOTAL
Broxtowe	225	1,974	272	342	244	1,712	83	1,370	11,391	17,613
Erewash	0	0	0	140	962	1,622	245	170	44	3,184
Gedling	0	0	0	0	0	0	9,630	0	0	9,630
Nottingham	333	8,871	2,937	0	6,700	0	1,325	0	4,605	24,771
Rushcliffe	421	0	1,675	930	498	401	1,251	1,655	667	7,498
CORE HMA	979	10,845	4,884	1,412	8,404	3,735	12,534	3,195	16,707	62,696

Source: Core HMA Councils / Lichfields’ analysis

- 5.43 Regarding the Outer HMA districts, comparisons are difficult due to the slightly longer timeframes for which detailed information is available, but nevertheless it appears that delivery levels have been significantly higher in Ashfield and particularly Newark and Sherwood in recent years than most of the Core HMA districts. Ashfield has seen 34,800 sqm delivered since 2000/01, very little of which was located in Hucknall.

⁶² ‘Charge of the conversions’, Planning magazine special report, 27 November 2014

⁶³ A plot ratio of 40% has been used to convert hectares to square metres where necessary

5.44 In this regard, Sherwood Park was designated as an Enterprise Zone [EZ] in 1995 and the associated benefits ran until November 2005. Of the 34,800 sqm of office floorspace brought forward in Ashfield, 7.13 ha (28,520 sqm) came forward on Sherwood Park and was delivered between 2000 and 2005/06, when the EZ designation was still in operation. Relatively limited office floorspace is recorded by ADC as having come forward since that time (just 6,280 sqm).

5.45 Furthermore, a significant amount of the office floorspace at Sherwood Park appears to be vacant, equal to around 18,500 sqm across 17 units.

5.46 Mansfield has seen less than a third of this annually, at a rate of 1,145 sqm p.a. In contrast, Newark and Sherwood has seen very high levels, totalling almost 53,000 sqm (4,814 sqm p.a.) with a particular spike in 2014/15 when 10,280 sqm was delivered, although it is fair to say that delivery has been fairly consistent across the 11-year monitoring period.

Table 5.6 Gross Annual Office Floorspace Completion Rates in Outer HMA, (sqm)⁶⁴

	2000/01 - 2008/09	2009/10	2010/11	2011/12	2012/13	2013/14	2014/15	2015/16	2016/17	2017/18	2018/19	2019/20	TOTAL
Ashfield	32,520	0	800	0	0	0	0	1,480	0	0	0	0	34,800
<i>...of which located in Hucknall</i>	0	0	800	0	0	0	0	0	0	0	0	0	800
Mansfield	n/a	n/a	n/a	84	435	0	152	2,865	436.5	922	1,769	3,642	10,306
Newark & Sherwood	n/a	5,629	342	5,080	160	3,120	10,280	1,720	6,120	5,360	11,480	3,663	52,954
OUTER HMA	n/a	5,629	1,142	5,164	595	3,120	10,432	6,065	6,557	6,282	13,249	7,305	

Source: Outer HMA Councils / Lichfields' analysis

5.47 Regarding industrial / distribution floorspace, completion rates were generally much higher almost across the board, with the 5 Core HMA districts seeing 130,396 sqm come forward over the 9-year monitoring period at an annual average rate of 14,488 sqm. Again, Gedling appears to be something of an outlier, with Officers recording only one year where significant employment development took place (2017/18). Broxtowe's delivery was dominated by a very large development by First Panattoni in 2019/20, which saw the delivery of the Nottingham 26 Eastwood site to accommodate a single industrial/distribution unit (use class B1c, B2 and B8) with associated service yards, parking, landscape and associated office facilities [planning application reference: 18/00090/REM] which is now occupied by Amazon.

⁶⁴ Ibid

Table 5.7 Gross Annual Industrial / Distribution Floorspace Completion Rates in Core HMA, (sqm)⁶⁵

	2011/12	2012/13	2013/14	2014/15	2015/16	2016/17	2017/18	2018/19	2019/20	TOTAL
Broxtowe	235	1,340	149	792	0	2,860	0	0	56,333	61,709
Erewash	4,600	1,827	453	2,458	7,584	1,689	2,886	4,110	5,651	31,257
Gedling	0	0	0	0	0	0	7,800	0	0	7,800
Nottingham	3,950	0	533	4,995	0	0	552	0	0	10,030
Rushcliffe	5,240	40	40	40	760	0	240	8,640	4,600	19,600
CORE HMA	14,025	3,207	1,175	8,285	8,344	4,549	11,478	12,750	66,584	130,396

Source: Core HMA Councils / Lichfields' analysis

5.48

Ashfield District has seen by far the most development in recent years, with 447,640 sqm coming forward since 2000/01. Of this, 12.77 ha was brought forward between 2000 to 2005/06, equivalent to 51,080 sqm, on Sherwood Business Park when the EZ was operational. This has featured some very substantial developments including a 163,000 sqm Amazon distribution warehouse at Summit Park in 2019/20.

Table 5.8 Gross Annual Industrial / Distribution Floorspace Completion Rates in Outer HMA, (sqm)⁶⁶

	2000/01 - 2008/09	2009/10	2010/11	2011/12	2012/13	2013/14	2014/15	2015/16	2016/17	2017/18	2018/19	2019/20	TOTAL
Ashfield	291,480	0	0	1,040	6,560	0	0	10,600	10,520	15,720	27,800	83,920*	447,640
<i>...of which located in Hucknall</i>	66,800	0	0	0	0	0	0	0	2,400	13,400	0	3,200	85,800
Mansfield	n/a	n/a	n/a	2,840	2,320	1,560	80	2,520	5,000	360	2,400	10,720	27,800
Newark & Sherwood	n/a	10,851	6,418	48,040	3,488	22,600	6,520	10,680	22,200	7,400	19,920	9,262	167,379
OUTER HMA	n/a	10,851	6,418	51,920	12,368	24,160	6,600	23,800	37,720	23,480	50,120	103,902	

Source: Outer HMA Councils / Lichfields' analysis

Losses and Net Completions

5.49

Losses are also recorded by the 8 district councils, with more data provided consistently than was available for the 2015 ELFS. Data stretching back to 2011/12 for the five Core HMA districts indicates that over 120,000 sqm of existing office floorspace was redeveloped for alternative uses, predominantly residential. Virtually no office floorspace was reported as having been lost by Gedling Borough Council Officers, which stands in stark contrast with the records of Nottingham City Council which indicates that well over 100,000 sqm, or 11,366 sqm per annum, was redeveloped for alternative uses.

⁶⁵ A plot ratio of 40% has been used to convert hectares to square metres where necessary

⁶⁶ Ibid. Whilst research across the two HMAs suggests that 40% represents a reasonable rule of thumb plot ratio overall and is in general accordance with standard practice, there will clearly be instances where the amount of floorspace is under/over-estimated as a result. One notable example is for Ashfield, where a 3-storey Amazon distribution warehouse was developed in 2019/20. This totalled 163,000 sqm over 19.3 ha, which is considerably greater than the 77,200 sqm that would be estimated based on the 40% plot ratio in the Table above. Whilst important to note, this does not have an impact on the modelling as industrial/warehousing requirements are calculated using the total hectareage, rather than floorspace.

Table 5.9 Gross Annual (former) B1a/b Office Floorspace Losses in Core HMA, (sqm)⁶⁷

	2011/12	2012/13	2013/14	2014/15	2015/16	2016/17	2017/18	2018/19	2019/20	TOTAL
Broxtowe	-1,447	-1,003	-389	-950	-371	-2,118	-1,776	-2,382	-1,052	-11,488
Erewash	-236	-320	-840	-262	-618	-263	-1,114	-1,183	0	-4,836
Gedling	0	0	0	0	0	0	0	0	-193	-193
Nottingham*	-2,000	-16,841	-11,142	-19,912	-7,256	-16,213	-17,900	-6,100	-4,928	-102,292
Rushcliffe	0	0	-437	-485	0	-916	0	0	-567	-2,405
CORE HMA	-3,683	-18,164	-12,808	-21,609	-8,245	-19,510	-20,790	-9,665	-6,740	-121,214

Source: Core HMA Councils / Lichfields' analysis

*Note: Nottingham City's figures comprise decline/loss to residential based on monitoring, plus a further 2,000 sqm pa lost to other uses, based on data provided by NCC Officers.

5.50

Regarding the Outer HMA districts, over 30,000 sqm has been lost over the past 11 years in Newark & Sherwood, and 19,375 sqm in Mansfield District at a rate of 2,153 sqm per annum.

Table 5.10 Gross Annual (former) B1a/b Office Floorspace Losses in Outer HMA, (sqm)⁶⁸

	2000/01 - 2008/09	2009/10	2010/11	2011/12	2012/13	2013/14	2014/15	2015/16	2016/17	2017/18	2018/19	2019/20	TOTAL
Ashfield	-1,920	-7,600	0	0	0	0	0	0	0	0	-1,040	0	-10,560
<i>...of which located in Hucknall</i>	-520	0	0	0	0	0	0	0	0	0	0	0	-520
Mansfield	n/a	n/a	n/a	-413	-463	-2,878	-9,475	-414	-1,151	-3,976	-247	-358	-19,375
Newark & Sherwood	n/a	-10,417	-3,672	-3,859	-120	-760	-1,880	-880	-6,960	-80	-1,640	-206	-30,474
OUTER HMA		-18,017	-3,672	-4,272	-583	-3,638	-11,355	-1,294	-8,111	-4,056	-2,927	-564	

Source: Outer HMA Councils / Lichfields' analysis

5.51

Regarding industrial / distribution floorspace losses, Table 5.11 identifies that almost 164,000 sqm was lost to alternative non-employment uses over the past 9 years, of which almost half was lost in Nottingham City.

Table 5.11 Gross Annual Industrial / Distribution Floorspace Losses in Core HMA, (sqm)

	2011/12	2012/13	2013/14	2014/15	2015/16	2016/17	2017/18	2018/19	2019/20	TOTAL
Broxtowe	-21	-711	-55	-21,583	0	-170	-2,193	-12,872	-758	-38,363
Erewash	-973	-1,299	-991	-5,258	-3,340	-5,598	-111	-8,434	-2,591	-28,595
Gedling	-2,760	-1,320	0	-2,760	0	-880	0	0	0	-7,720
Nottingham*	-13,802	-7,445	-5,757	-4,725	-4,673	-5,042	-4,500	-6,600	-25,630	-78,174
Rushcliffe	0	0	-200	0	-7,200	-400	0	0	-3,200	-11,000
CORE HMA	-17,556	-10,775	-7,003	-34,326	-15,213	-12,090	-6,804	-27,906	-32,179	-163,852

Source: Core HMA Councils / Lichfields' analysis

*Note: Nottingham City's figures comprise decline/loss to residential based on monitoring, plus a further 4,000 sqm pa lost to other uses, based on data provided by NCC Officers.

⁶⁷ A plot ratio of 40% has been used to convert hectares to square metres where necessary

⁶⁸ Ibid

5-52

Very large amounts of industrial/distribution floorspace have been lost in Ashfield in particular, with 84,120 sqm lost in the first 9 years of the monitoring period, and 168,120 sqm in total. In contrast, limited floorspace was lost in Mansfield and particularly Newark & Sherwood.

Table 5.12 Gross Annual Industrial / Distribution Floorspace Losses in Outer HMA, (sqm)

	2000/01 - 2008/09	2009 / 10	2010 / 11	2011 / 12	2012 / 13	2013 / 14	2014 / 15	2015 / 16	2016 / 17	2017 / 18	2018 / 19	2019 / 20	TOTAL
Ashfield	-84,120	-160	-26,520	-880	-1,960	-2,760	-20,960	-7,400	0	-2,040	-7,880	-13,440	-168,120
<i>...of which located in Hucknall</i>	-24,640	0	0	0	-1,960	0	-4,680	0	0	-2,040	-480	-1,640	-35,440
Mansfield	n/a	n/a	n/a	-40	-3,040	-200	0	-400	-1,080	-1,040	-1,200	-148	-7,148
Newark & Sherwood	n/a	-703	-248	-261	-680	-400	-200	-720	0	-40	-240	-320	-3,812
OUTER HMA	n/a	-863	-26,768	-1,181	-5,680	-3,360	-21,160	-8,520	-1,080	-3,120	-9,320	-13,908	

Source: Outer HMA Councils / Lichfields' analysis

Net analysis

5-53

Taking account of all employment developments and losses to other uses, the Core HMA has seen an overall net completion of -6,500 sqm of employment floorspace per annum over the 2011/12-2019/20 9-year period. As Table 5.13 shows, this was driven by losses of office space in Nottingham City in particular. As for the Outer HMA, whilst direct comparisons are again harder due to the differing monitoring periods of these three authorities, overall, there was a net increase of around 2,250 sqm per annum, driven by Newark & Sherwood and, to a lesser extent, Ashfield. Mansfield experienced a net loss over the past 9 years.

Table 5.13 Gross/Net Annual Net Office Completion Rates

	Average Annual Gross Completions (sqm)	Average Annual Gross Losses (sqm)	Average Annual Net Completions of Office (sqm)
Broxtowe	1,957 sqm	-1,276 sqm	+681sqm
Erewash	354 sqm	-536 sqm	-182 sqm
Gedling	1,070 sqm	-21 sqm	+1,049 sqm
Nottingham	2,752 sqm	-11,366 sqm	-8,613 sqm
Rushcliffe	833 sqm	-267 sqm	+566 sqm
CORE HMA	6,966 sqm	-13,466 sqm	-6,500sqm
Ashfield	1,740 sqm	-528 sqm	+1,212 sqm
<i>...of which located in Hucknall</i>	40 sqm	-26 sqm	+14 sqm
Mansfield	1,145 sqm	-2,153 sqm	-1,008 sqm
Newark & Sherwood	4,814 sqm	-2,770 sqm	+2,044 sqm
OUTER HMA	7,699 sqm	-5,451 sqm	+2,248 sqm

Source: HMA Councils / Lichfields' Analysis

5-54

Regarding net industrial / distribution completion rates, Table 5.14 indicates that the Core HMA experienced a net loss of over 3,700 sqm per annum, which was driven entirely by Nottingham City's substantial net loss of such land (-

7,572 sqm per annum), with the other 4 Core HMA districts actually seeing a net increase in completions (even if Gedling's 9 sqm per annum is negligible).

5.55

The net increase of industrial / distribution floorspace across the Outer HMA is very significantly positive, at over 31,100 sqm per annum, driven largely by Ashfield and Newark & Sherwood districts.

Table 5.14 Gross/Net Annual Net Industrial / Distribution Completion Rates

	Average Annual Gross Completions (sqm)	Average Annual Gross Losses (sqm)	Average Annual Net Completions of Industrial / Warehousing (sqm)
Broxtowe	6,867 sqm	-4,263 sqm	+2,594 sqm
Erewash	3,473 sqm	-3,177 sqm	+296 sqm
Gedling	867 sqm	-858 sqm	+9 sqm
Nottingham	1,114 sqm	-8,686 sqm	-7,572 sqm
Rushcliffe	2,178 sqm	-1,222 sqm	+956 sqm
CORE HMA	14,489 sqm	18,206 sqm	-3,717 sqm
Ashfield	22,382 sqm	-8,406 sqm	+13,976 sqm
<i>...of which located in Hucknall</i>	4,290 sqm	-1,772 sqm	+2,518 sqm
Mansfield	3,089 sqm	-794 sqm	+2,295 sqm
Newark & Sherwood	15,216 sqm	-347 sqm	+14,870 sqm
OUTER HMA	40,687 sqm	-9,547 sqm	+31,141 sqm

Source: HMA Councils / Lichfields' Analysis

5.56

There is an important caveat to the data in the Tables above as it relates to Ashfield District Council. Robust data was provided by the Council regarding completions and losses over an extended time period stretching back to 2000/01. Where this is the case, ordinarily we would prefer to examine longer term trends that take into account a number of development cycles. For Ashfield District it is important to note that depending upon how far back one goes, this has a significant impact on the gross and net completion rates due (in part) to the presence of the Sherwood Park Enterprise Zone which was very successful in attracting office and (to a lesser extent) industrial development to the area in the first few years of the Millennium, to November 2005.

5.57

As can be seen in Table 5.15, if the shorter time period of 2011/12-2019/20 is taken as the basis for past take up/losses, then both the gross and net completions rate declines. The amount of office floorspace taken up over this period fell significantly, to just 164 sqm per annum which, aligned with a much lower rate of losses, results in a net annual take up rate of 48 sqm rather than 1,212 sqm over the longer time period. As for industrial floorspace, the difference is less pronounced although here too the figures are reduced. The gross take-up equates to 17,351 sqm per annum (down from 22,382 sqm over the longer term); losses are also lower, at -6,369 sqm per annum, resulting in a net annual take up of 10,982 sqm – below the 13,976 sqm p.a. recorded from 2000/01.

Table 5.15 Gross/Net Annual Net Industrial / Distribution Completion Rates for Ashfield District – Alternate Monitoring Timeframes

	Use	Average Annual Gross Completions (sqm)	Average Annual Gross Losses (sqm)	Average Annual Net Completions of Industrial / Warehousing (sqm)
2000/01 – 2019/20 (20 years)	Office	1,740 sqm	-528 sqm	+1,212 sqm
	Industrial	22,382 sqm	-8,406 sqm	+13,976 sqm
2011/12 – 2019/20 (9 years)	Office	164 sqm	-116 sqm	+48 sqm
	Industrial	17,351 sqm	-6,369 sqm	+10,982 sqm

Source: HMA Councils / Lichfields' Analysis

VOA Comparison

5.58 The losses data has been 'sense checked' against the latest VOA administrative data on business/industrial floorspace (as at 31st March 2020). Whilst the VOA data represents the net change in the amount of floorspace over time (and hence it cannot be used to work out the precise level of losses/gains), it is fairly consistent over time, and can be used to help provide a degree of external validation of whether the Council's monitoring figures are reasonably accurate.

5.59 The office net completions are summarised in Table 5.16, with the industrial/warehousing completions in Table 5.17. Six of the 8 Nottingham HMA district councils have provided completions/losses data on a consistent basis between 2011/12 and 2019/20; Ashfield District has provided consistent data stretching back to 2000/01, whilst Newark & Sherwood also has robust data for 2009/10 and 2010/11.

5.60 In general, most of the data appears reasonably consistent given that they are collected via very different methods and may have something of an overlap/delay with the recording timeframes.

5.61 The ones that may at first glance be viewed as potential anomalies are:

- **Broxtowe's office floorspace:** this is primarily due to the VOA data indicating no net gain in office floorspace between 2018/19 and 2019/20, whereas the Council's monitoring indicates that around 11,391 sqm of office floorspace was developed in 2019/20 with just 1,052 sqm lost to alternative uses. This discrepancy suggests that either a substantial amount of office floorspace was lost in the past year without the Council being aware of it, or (as is perhaps more likely) the completion came forward towards the end of the monitoring year and is not fully occupied and may fall into the next VOA year for 2020/21.
- **Broxtowe's industrial floorspace:** a similar pattern is observed as set out above for the office floorspace – well over half of the discrepancy is confined to the most recent monitoring year, where the VOA data indicated no net gain in industrial floorspace between 2018/19 and 2019/20, whereas the Council's monitoring indicates that around 56,333 sqm of industrial floorspace was developed in 2019/20 with just 758 sqm lost. Again, it might be anticipated that the next VOA records for 2020/21 will bring the two back into balance.

- **Nottingham City's industrial floorspace:** this is entirely due to the data for 2018/19 in the VOA, which suggests that in that year there was a net loss of 108,000 sqm - however the Council's data suggests that only 6,600 sqm was lost in that year (and 25,630 sqm for the year after, which is not available in the VOA yet). It is understood that this apparent discrepancy was due to the redevelopment of the very large former Imperial Tobacco factory, which was not a technical loss as the Horizon Factory site will be replaced by industrial buildings and warehouses. This consequently shows up (temporarily) on the VOA data, but not the Council's net completions.
- **Ashfield's office floorspace,** although this may be due to an anomaly in the VOA data - VOA increased from 34,000 sqm in 2004/05 to 90,000 sqm in 2005/06, a difference of 56,000 sqm, compared to only 18,000 sqm of recorded completions for that year. It is understood that the reason for this is likely to be Sherwood Park's designation as an Enterprise Zone. The designation of an Enterprise Zone was made in accordance with the Local Government Planning and Land Act 1980 (Schedule 32). A statutory instrument (1995 No.278) designated The East Midlands Enterprise Zones (Ashfield) (Designation) Order 1995. It ran for 10 years from 21st November 1995 and was known as East Midlands Enterprise Zone No. 7 (Sherwood Business Park). As reported in the 2015 ELFS, one potential reason underpinning the substantial increase in Ashfield District's office floorspace figures in 2005 (and also the rise in industrial buildings in 2005) is that the fiscal benefits from the Sherwood Park EZ expired in 2005. Therefore, the buildings on the EZ that would previously have been exempt from business rates came onto the VOA valuation list together when the designation expired.
- **Newark and Sherwood's industrial floorspace:** The VOA data suggests that the total amount of industrial floorspace has remained roughly the same since 2009, while data from Newark & Sherwood District Council monitoring indicates that completions significantly outweigh losses. These data are collated differently, and the discrepancy may reflect the fact that the VOA data includes changes that take place outside the planning system and would not be picked up by District Council monitoring.

Table 5.16 Comparison between Council Recorded Office Completion Rates and VOA

	Observed Net Completions of Office (sqm)	VOA	Difference
Broxtowe (2011-2020)	6,125	-19,000	+25,125
Erewash (2011-2020)	-1,636	0	-1,636
Gedling (2011-2020)	9,437	4,000	+5,437
Nottingham (2011-2020)	-77,521	-84,000	+6,479
Rushcliffe (2011-2020)	5,093	8,000	-2,907
CORE HMA (2011-2020)	-58,502	-91,000	32,498
Ashfield (2000-2020)	24,240	73,000	-48,760
Mansfield (2011-2020)	-9,070	1,000	-10,070
Newark & Sherwood (2009-2020)	22,479	6,000	16,479
OUTER HMA (varies)	37,649	80,000	-42,351

Source: HMA Councils / VOA 2020 / Lichfields' Analysis

Table 5.17 Comparison between Council Recorded Industrial / Warehousing Completion Rates and VOA

	Observed Net Completions of Industrial / Warehousing (sqm)	VOA	Difference
Broxtowe (2011-2020)	23,346	-61,000	+84,346
Erewash (2011-2020)	2,622	-16,000	+18,622
Gedling (2011-2020)	80	-5,000	+5,080
Nottingham (2011-2020)	-68,144	-205,000	+136,856
Rushcliffe (2011-2020)	8,600	16,000	-7,400
CORE HMA (2011-2020)	-33,496	-271,000	+237,504
Ashfield (2000-2020)	279,520	268,000	-11,520
Mansfield (2011-2020)	20,652	28,000	-7,348
Newark & Sherwood (2009-2020)	163,567	-5,000	+168,567
OUTER HMA (varies)	463,739	291,000	172,739

Source: HMA Councils / VOA 2020 / Lichfields' Analysis

Logistics and E-Commerce

5.62

Logistics is a key part of the UK economy, both as a generator of employment and output in its own right and as a key enabler of economic activity across a broader range of sectors. At the national level, improved logistics arrangements are referenced within Government's Industrial Strategy⁶⁹ as one of the benefits of working collaboratively across appropriate economic geographies, whilst research by Lichfields in 2016⁷⁰ found that the transport and logistics sector was identified as a priority within 11 LEP strategy documents including D2N2. The

⁶⁹ Industrial Strategy: Building a Britain fit for the future, HM Government

⁷⁰ Invest to Grow: How Can Planning Support Inward Investment? Lichfields (2016)

logistics industry plays a vital role in the UK's economy. It generates £77.1bn, or 4.2% of the UK's total Gross Value Added [GVA]⁷¹, and employs 1.6m people⁷².

- 5.63 A significant trend that has been driving change in the logistics industry, and one that has been accelerated due to the Covid-19 Pandemic and associated lockdowns, is the rising role of ecommerce and the associated consumer expectations for flexibility. Online retailers benefitted from a year-on-year increase in sales of 9.1% to £76bn in 2018, with online retail taking a 17.8% share of all retail sales in 2018 (rising from 10.6% in 2012)⁷³. As well as increasing the number of deliveries, consumers also increasingly expect flexible delivery options, 'click and collect' services, and specific delivery times. This generates more demand for the logistics industry and it will continue to grow as consumer behaviour increasingly moves online, with 72.5% of the UK's population eShoppers – the highest proportion of any comparable country in Europe⁷⁴.
- 5.64 Agents noted that retailers have rapidly upgraded their digital platforms to improve experience and reliability whilst simultaneously increasing their distribution infrastructure across the country. Both are major investments and can be seen as moves that will make a number of these immediate reactions more permanent features of the sector. Consequently, it was suggested that online retailers will increasingly require larger warehouses and distribution space in order to hold, process and distribute their growing stock.
- 5.65 According to commercial property agents, supply chains are increasingly moving away from a linear model (serving the store networks) towards a centric model, where the consumer dictates timings and stock replenishment operations. As the pandemic has accelerated consumer adoption of online commerce, the provision of logistics stock has never been more critical.
- 5.66 Whilst lockdown policies have meant an overall fall in retail sales throughout 2020 of 1.9%, the amount spent on online retail in 2020 increased by 46.1% when compared with 2019 as a whole, the largest annual increase since 2008. Food-stores recorded the largest increase in online sales at 79.3% for the year, a record increase for the sector.

⁷¹ Office for National Statistics (December 2018) Regional Gross Value Added (Income Approach)

⁷² Experian (2019) UK Local Market Forecasts

⁷³ Centre for Retail Research Total Online Retail Sales 2018-2019 <https://www.retailresearch.org/online-retail.html>

⁷⁴ Ibid

Figure 5.10 Volume sales, seasonally adjusted, Great Britain, December 2017 to December 2020

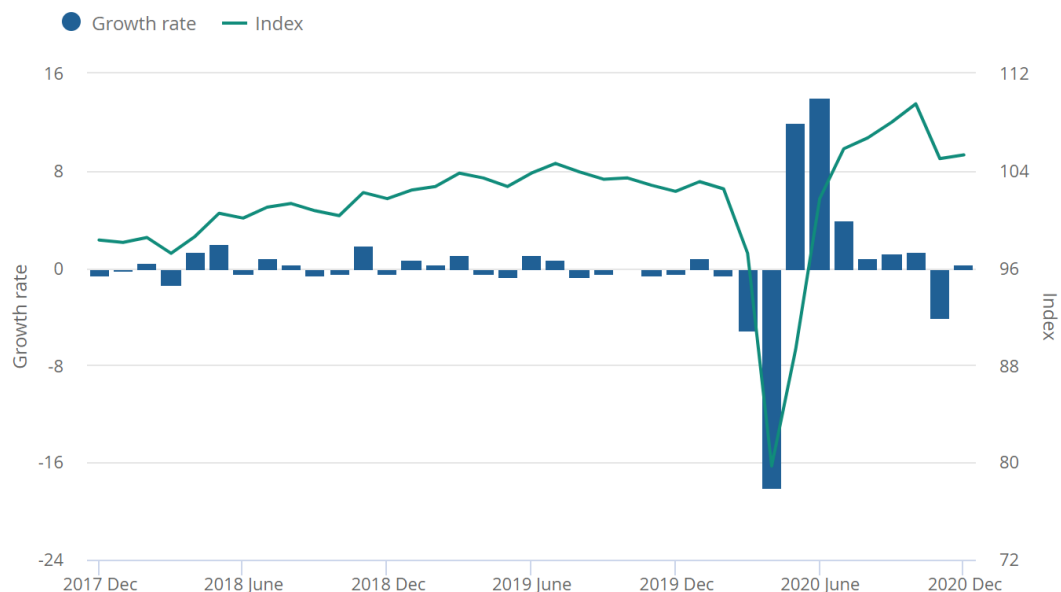

Source: ONS (2020): *Retail sales, Great Britain: December 2020*

Commercial Overview

5.67 Lichfields consulted with Councils' Economic Development Officers, the Federation of Small Business, Invest in Nottingham, commercial property agents and other local stakeholders to gain an understanding of the current characteristics of the Greater Nottingham commercial property market, the supply and demand of employment sites and probable future trends.

Commercial Property Market Stakeholder Engagement

5.68 There was a clear message from stakeholders that despite the economic slowdown and uncertainty resulting from the Covid-19 pandemic and Brexit that the market has performed beyond expectations over the past 12 months, with a few main trends emerging that have accelerated demand in particular for logistics and distribution floorspace. Agents reported that the level of current demand for industrial and logistics space within the East Midlands is unprecedented since at least the financial crash of 2008 due to the accelerating shifts in consumer purchasing behaviour towards online retail. Whilst less pronounced, there are also emerging trends in the office market as a result of the pandemic that may have lasting effects on the nature of demand, driven predominantly by the large-scale shift towards home working and the resulting changes in business and commuter preferences.

Current Trends

5.69 The market for B8 employment space has performed strongly over the past few years, both nationally and within the East Midlands. 2018 was a record year for take up nationally at 31.5m sq. ft (2.93m sqm), with the East Midlands being the biggest contributor followed by Yorkshire and the North East. 2019 proved to be another strong year with take up of 25.38m sq. ft (2.36m sqm) nationally (the

4th best year on record), with the East Midlands again being the largest contributor at 37% of take up⁷⁵.

- 5.70 Despite the record economic downturn for most sectors of the economy, 2020 has proven to be a record year for the logistics industry nationally. New leases were signed for a total of 50.1m sq. ft (4.65m sqm) of warehouse space: higher than the previous record set in 2016 by a significant 12.7m sq. ft (1.18m sqm) or more than a 33% increase⁷⁶. Similarly, this take-up comprised 165 separate transactions, beating the previous record of 163 set in 2014. Overall, take-up in 2020 was 80% higher than the long-term average. Another notable factor of the year was the surge in take-up of units over 500,000m sq. ft (46,452 sqm) with 25 deals recorded, the highest number on record and more than the previous two years combined. Given current market activity and requirements for units over 500,000 sq. ft (46,452 sqm), this trend is expected to continue.
- 5.71 Supply has fallen by 3.8m sq. ft (353,000 sqm) over the course of 2020, falling to 32m sq. ft (2.97m sqm) at a vacancy rate of 5.7%. This is, in part, due to the highest level of deals for speculatively developed space ever recorded at 10.8m sq. ft (1m sqm). This rapid take-up has depleted the supply of Grade A space which stands at 12.9m sq. ft (1.2m sqm), accounting for 41% of total supply – the lowest level of supply since 2017 and a fall of 55% compared to just 12 months ago.
- 5.72 2020 proved to be another record year for take-up the East Midlands, with the logistics industry in particular responding to heightened demand as a result of Covid-19 and the periods of lockdown which persisted throughout most of the year. Take up reached a record 12.03m sq. ft (1.1m sqm) across 32 transactions, 30% higher than the previous record and 38% higher than take-up in the region in 2019⁷⁷. Nine deals over 500,000 sq. ft (46,452 sqm) took place in the region in 2020, 350% above the annual average of two deals per year in the size bracket. The demand for larger units is further evidenced in the average size deal which has increased by over 27% in the past 10 years to reach c.375,865 sq. ft (34,919 sqm).
- 5.73 The record levels of take-up within the East Midlands have led to a reduction in the supply of units over 100,000 sq. ft (9,290 sqm), with 26 units available totalling 5.75m sq. ft (534,192 sqm) in January 2021 – an 8% decrease from a year previously. Regional vacancy also remains low at 5.16% due to the heightened activity. The five-year average annual take-up indicates there is currently just 0.69 years' supply in the market.⁷⁸

Working from Home

- 5.74 Another factor that will influence the future skills requirements of the industry are the increased levels of working from home resulting from the Covid-19 lockdown.

⁷⁵ CBRE & Caddick Developments (July 2020): *Market Overview - Osberton*

⁷⁶ Savills (Jan 2021): *Spotlight: Big Shed Briefing*

⁷⁷ Savills (Jan 2021): *The logistics market in the East Midlands*

⁷⁸ Savills (Jan 2021): *The logistics market in the East Midlands*

Figure 5.11 Levels of Home-Working in England 1998 - 2017

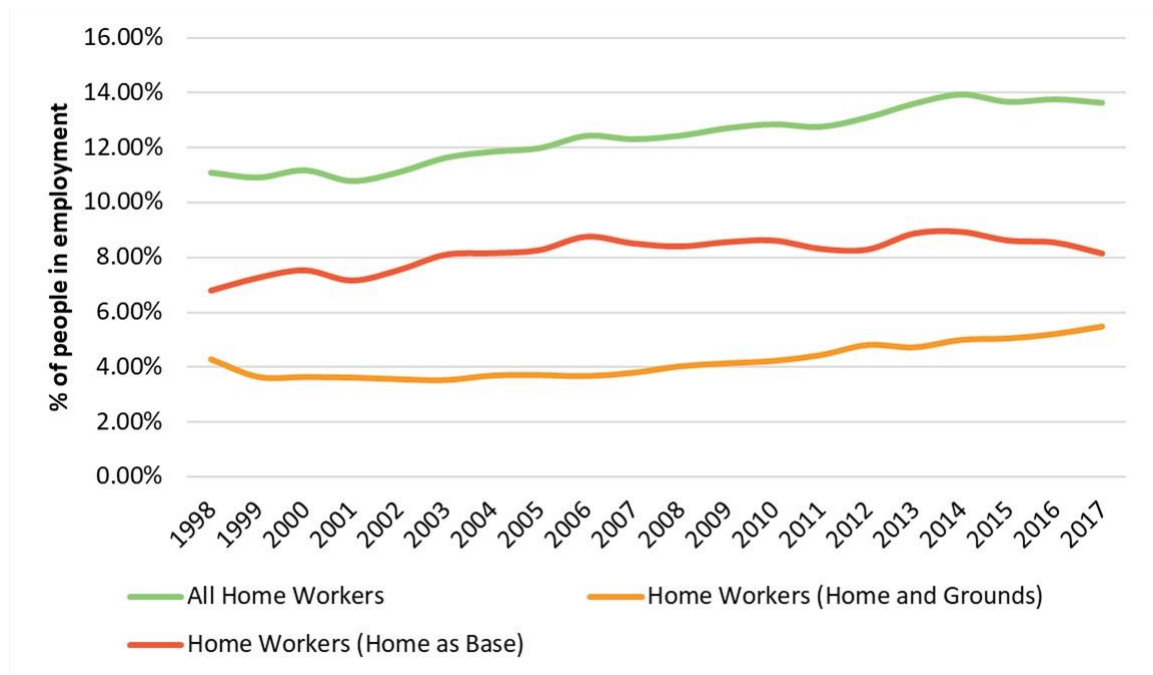

Source: ONS (2020): *Labour Force Survey*

5-75 The ONS Labour Force Survey (2020) shows that there has been a steady rise in the proportion of people in employment of those working from home, either working directly from the home or using home as a base⁷⁹. In 2017, this stood at 13.6% of people in employment. Home working typically increases with age (increasing from 5.1% of those age 16-24 to 38.3% of people age 65+ using their home for work) and so the ageing in the population is likely to lead to further increases in home working.

5-76 The impact of the Covid-19 pandemic has had a profound impact on the profile of home working. Whilst the highest rates of home-working experienced during the peak of lockdown may not be sustained over the long term, there is a widespread expectation that the working practices that were forced upon many people will lead to a structural shift, with fewer people working from offices full time and more choosing to work from home on a part time, if not full time, basis.

5-77 Whilst the logistics industry still largely requires many workers to be physically located on site, the rising number of IT-based and managerial jobs as well as the effects of automation within the industry may increase the possibilities for home working in some roles, opening up the possibility of such roles being performed remotely and widening the available labour pool. Certainly, the industry will feel the effects of sustained levels of working from home within other industries as this is again likely to increase the demand for online retail.

⁷⁹ Note: homeworking, for the purposes of the Labour Market Survey [LMS], refers to someone undertaking some work from home in the reference week of the survey.

Industrial and Distribution Space

- 5.78 The level of demand for industrial and distribution floorspace and the need for an increased supply of available sites was stressed as a point of significance by all commercial agents consulted. Agents reported that this market has been performing above all expectations over the past twelve months with vacancy rates at all-time-lows and the only limiting factor being the supply available. Stakeholders suggested that the “Golden Triangle” for logistics is quickly expanding northwards along the M1, with occupiers taking advantage of lower rents, comparable transport links and the availability of labour relative to further south.
- 5.79 Numerous stakeholders noted that the logistics and distribution industry is rapidly evolving with the common view of B8 employment being outdated. Occupiers are looking to squeeze as much as they can out of units and different floorspace requirements are beginning to emerge. Not only has the demand for large units increased, but occupiers now often want taller units capable of accommodating larger cranes and equipment; and often seek mezzanine floorspace. Furthermore, occupiers increasingly need flexible units as they require multiple uses (office/B2/B8) within the same unit and the capability to flex the precise mix of these uses in response to market conditions. Further flexibility is required in car parking, electric charging points etc. as modern occupiers also want the ability to rapidly increase or decrease the size of the workforce operating from a particular site in response to seasonal market conditions.
- 5.80 It was suggested that much of the sub-region’s historic demand for warehousing was indigenous, whereas now enquiries are increasingly from businesses looking to relocate from elsewhere. Enquiries were said to have increased for units of all sizes albeit with a clear split: national distribution centres ranging from 500,000 sq. ft (46,452 sqm) up to a million sq. ft (92,903 sqm) and smaller regional and last-mile distribution units in the range of 200,000 sq. ft (18,581 sqm) or less.
- 5.81 Rising demand for last-mile distribution units was highlighted as a key trend, with companies such as DPD, Hermes etc. who feed off the larger national distribution centres looking for smaller units usually located on traditional industrial estates. Due to the need to be operational 24/7 354 days a year, this demand is not typically suited to units close to residential areas.
- 5.82 Agents were clear that in order to meet the needs of the logistics sector, sites capable of accommodating significant levels of new logistics floorspace will be required in Greater Nottingham at locations well related to the trunk road networks (M1 corridor).

Core HMA

- 5.83 In terms of where demand is focussed, several agents pointed towards the western arc of Nottingham City running southwards as being the area of highest demand and particularly around J26 of the M1, although it was stressed that available space near J24 through to J28 would all be in high demand. Stakeholders indicated that areas to the south of the City along the M1 have the

most potential for employment growth over the next 10 to 15 years due to the focus on the M1 corridor by distribution occupiers seeking large purpose-built units. In terms of rents, agents reported that there have been increases of 5-10% over the past year, with rents on smaller units (c.5,000 sq. ft / 465 sqm) increasing more than for larger units. A smaller unit with access to the M1 will bring around £7 per sq. ft whilst larger units see around £6.50.

5.84 The Castlewood Business Park at J28 was highlighted as the type of scheme that would be in high demand at any of the M1 junctions within the region (again, the further south the better). Blenheim Industrial Estate is an example of an Industrial Estate closer to the urban centre that still benefits from M1 access. These schemes are also ideal for expansion, as existing large occupiers seek to accommodate more and more floorspace without the need to relocate away from their workforce.

5.85 Agents noted that whilst the western arc of Nottingham is in the highest demand, it is also increasingly constrained in terms of land availability. Occupiers are being squeezed out of the City, presenting real opportunities to surrounding districts. Occupiers are increasingly prioritising locations in the vicinity of an available workforce as labour requirements increase and see untapped potential in smaller settlements. Rushcliffe and Gedling in particular were raised as areas that may be able to capture some growth due to the available workforce, although demand in these areas is typically for smaller units of 15,000 sq. ft (1,394 sqm) and below.

Outer HMA

5.86 Industrial and distribution demand in the Outer HMA remains healthy, although distribution demand was said to be weaker along the A1 corridor towards Newark and Sherwood than it was closer to the M1. Demand that exists along the A1 Corridor tends to be for smaller units. Agents saw the A1 Corridor as being more of a risk as it would likely be the first to see rising vacancies throughout an economic downturn. Units without easy access to the M1 are said to achieve rents of £1 to £1.50 per sq. ft below what could be achieved near the M1.

5.87 Ashfield is proving to be a very successful location due to the ease of access to the M1, having delivered numerous successful business parks in recent years. The Sherwood Business Park at J27 was raised as the type of scheme that developers and agents would like to see expanded, if not recreated at other key junctions.

5.88 Mansfield is less well served by the strategic road network and demand remains largely indigenous, catering to the local market.

5.89 Newark and Sherwood may also struggle to attract larger occupiers due to the weaker transport links and thus smaller available labour pool. However, there is still a market for smaller units of around 5 – 10,000 sq. ft (465-929 sqm) along the A1 and there remains a real lack of supply, which is pushing rents up gradually on smaller units.

- 5.90 Away from the main urban areas and transport corridors, demand for industrial and warehousing premises continues to be indigenous, and speculative development is often unviable without public funding assistance.

Future Outlook

- 5.91 Property agents were of the opinion that employment growth across Greater Nottingham has been limited by a lack of available high-quality sites over the past decade, and that studies forecasting need based purely on past trends will significantly underestimate the scale of demand. Agents were confident that there could even be capacity in the market for one or two very large distribution schemes along these key M1 junctions and that at current levels of demand two such schemes would be at capacity within a decade.
- 5.92 Agents pointed towards a number of difficulties facing councils when allocating sufficient land to meet demand. With demand for units of anywhere from 500,000 sq ft up to 2 million sq ft increasing, there are increasing barriers to allocating adequate land to serve authorities due to the sheer size of allocations needed to provide for just one or two occupiers. Add to this the Green Belt constraints around Nottingham and finding available land in the most in-demand locations becomes difficult. Agents also highlighted the scale of opportunity available when attracting large occupiers in that developers are willing to find significant infrastructure upgrades up-front due to the sheer amount of floorspace that can be occupied within just one or two deals, as opposed to a residential scheme when hundreds of individual deals are required.
- 5.93 Looking forward, stakeholders agreed that the market is far from saturation point and the current levels of demand are likely to persist. All agreed that opportunities have been, and continue to be, lost in Greater Nottingham due to a lack of available floorspace in the right locations. There is a preference from developers to expand existing sites with capacity rather than risk disruption to road networks by grouping smaller sites close to one another. Ideal sites for distribution are seen to be in the range of 50 – 60 hectares, with units of around a million sq ft that can be split into 5/6 smaller units or 1/2 large ones. For smaller industrial units, opportunities lie in existing business parks close to urban centres. All stakeholders stressed that a pro-development mindset is required to capture the potential within Greater Nottingham and that bringing sites forward quickly should be the first priority.
- 5.94 Evidence was provided from Avison Young [AY]⁸⁰ to Lichfields regarding the Logistics Market along the M1 corridor from Junction 24 of the M1 to Junction 28 (see Appendix 7). AY considers that this is a prime location for logistics activities given its ability to provide access to a large number of major cities in England and to serve local and regional markets.
- 5.95 AY report that CoStar data shows that the average annual net take-up of space over the past 10 years (2010-2019) has been of c. 820,000 sq ft. in the M1 J24/28 area. With currently 2 million sq ft. of vacant floorspace, the M1 J24/28

⁸⁰Avison Young (January 2021): Logistics Market Review – focused on the M1 Corridor between Junction 24 and Junction 28.
Avison Young (February 2021): Market Report: Land off Junction 27 M1

area has sufficient space to respond to the demand for the next 2.5 years only. The East Midland market and the M1 J24/28 area have performed particularly well, with an increased number of leases signed in 2020 (April to December) compared to the historical average.

- 5.96 Agents considered that the success of East Midlands Gateway and take up elsewhere demonstrates that trajectory based methods of assessing employment land use requirements have not been able to anticipate the changing needs of the logistics sector, and in turn the demand for new floorspace and the land required to meet the demand.
- 5.97 The sector continues to evolve and demand shows no sign of abating and there was a view expressed by agents that we will continue to see significant demand for new and modern warehousing and, in turn, the requirement for large sites in suitable locations.
- 5.98 Agents stated that on a more localised basis, in almost all parts of Greater Nottingham the supply of prime sites is almost non-existent. They reported that there is a clear need for sites to be brought forward in the very short term to meet demand and help the economy adjust to and recover from the Covid recession. In the medium/longer term, agents made it very clear that it was their view that very significant areas of land will need to be identified to meet the ongoing needs of the logistics sector.
- 5.99 In the medium to longer term, AY reported that they expect to see a continued increase in demand for B8 space, particularly focused in prime locations (such as the M1 J24/28 area) due to the impact of Covid-19 on consumers' behaviour and the rise of e-commerce; the renewed importance of building up stock contingency; the progression of technology (space requirement to accommodate that technology within logistic activities as well as increase demand from data centres); or the reshoring of some of the production (increasing the demand for industrial space but also for B8 space for additional warehousing and distribution).
- 5.100 AY conclude that for the area to be able to enjoy the benefits of investment by major businesses it is essential that suitable land is made available for development. *“This must be in locations which enjoy excellent motorway access as offered by the subject land. Two examples are Amazon’s acquisition of the 551,031 sq ft Panattoni Park Eastwood and their acquisition of 1,752,165 sq ft at Summit Park, Mansfield in 2019. It was notable that last year saw Alloga who have a concentration of operations at Junction 28 having to acquire a 370,991 sq ft speculative building in Derby to meet their immediate occupational needs due to a lack of space local to their existing operations.”* [paragraph 5.4, Avison Young (February 2021): *Market Report: Land off Junction 27 M1*]

Office Space

- 5.101 In contrast to the Industrial sectors, there was less focus on office space in the stakeholder conversations. When raised, agents tended to focus on the lack of Grade A office available in Nottingham City, whilst noting that there may be

emerging opportunities for the surrounding urban centres despite current demand remaining subdued for obvious reasons.

Core HMA

- 5.102 Stakeholders identified that there remains limited choice for high quality office space in Nottingham City. The lack of large units available within the City was said to be causing many larger occupiers to move out into business parks, often closer to where staff would usually commute from, even before the effects of the pandemic took hold. This was said to be leaving larger units in the City to be carved up into smaller and more flexible office space that better suit the needs of firms looking to relocate. In Nottingham City, primary rents stand at around £20 per sq ft whilst secondary rents are around £15 per sq ft, seeing small growth over the past year although secondary rents are catching up to primary. For comparison, primary and secondary rents in Derby stand at around £16.50 and £9 per sq ft respectively.
- 5.103 A key source of enquires for office space in the City was that of businesses in innovative sectors such as technology, biosciences and software development. Often these businesses are looking to relocate from London and the Greater South East due to a desire to expand (typically having around 25 – 50 employees) but having a limited available pool of labour for which there is fierce competition. Whilst this is an existing trend, these business may now seek to capitalise on the opportunities presented by increased levels of homeworking to move to cheaper office space in more northerly towns and cities where they can also more easily access a skilled workforce.
- 5.104 The types of units these businesses require are of the kind at existing developments such as Bio-city, Medi-city, the Nottingham Science Park and the Boots Enterprise Zone. Stakeholders stressed that an increased supply of these smaller, modern and flexible office units would be in high demand both in the City and within smaller town centres that have good transport connections.
- 5.105 Agents did not, however, report a sudden rush for office space in business parks despite the increasing constraints on space in the City and the emerging changes in office demand as a result of the pandemic. Office vacancy levels within business parks remain much higher than within the City Centre, with some locations having a vacancy rate of up to 10% and units taking considerably longer to let than those within urban centres. Agents stated that there has been no apparent growth in rents for office space within the past year and in fact that rents on out-of-centre office units have remained relatively static since the last financial crisis.

Outer HMA

- 5.106 Demand for office premises in the Outer HMA remains relatively weak and highly localised in nature. Rents were said to have risen slightly in areas where supply is particularly constrained such as Newark and Sherwood but remain at around the £5 – 10 per sq ft mark in most cases. Low rents in the outer HMA restrict the viability of speculative builds in most locations.

- 5.107 Urban centres in the outer HMA have, however, seen success in providing high-quality office space with good transport links, a trend that many stakeholders can foresee continuing as office space within the Core HMA becomes increasingly constrained and businesses explore options for relocating to cheaper premises that still have a rounded offer.
- 5.108 There is still a difficulty in bringing older units back to the market as business needs rapidly change, with such units remaining largely unviable due to high costs and low rents.
- 5.109 As with the trends emerging in Nottingham City Centre, flexible and managed workspaces for small businesses are seen as an opportunity, particularly those within mixed-use developments or near to urban centres that do not result in workers becoming isolated from transport links and leisure activities.
- 5.110 Outside of urban centres, office provision in business parks has had mixed success in attracting new business, with most units occupied by firms catering to the local market.

Future Outlook

- 5.111 In terms of the future needs of commercial businesses, whilst it is difficult to obtain a longer-term view given the uncertain economic climate and rapidly changing business practices, this is clearly an important area of analysis given the dynamically changing economy.
- 5.112 The view was expressed by many stakeholders that Councils should be actively pursuing higher-quality Grade A town centre office space to attract new digital-age businesses, national / international businesses, as well as potentially providing Head Quarter office space for local high growth businesses. It was also mentioned that district centres have a role to play in providing high-quality modern office space to businesses who are increasingly willing to relocate from City Centre locations out towards cheaper units closer to the homes of their workforce.
- 5.113 Council Economic Development Officers and representatives from the Federation of Small Businesses [FSB] expressed the view that there was a clear need to embrace new start-up businesses and examine the needs of technology businesses and professional services who may wish to share cohabiting space with other non-employment uses such as leisure and coffee shops. Given the quality of much of the built environment within Nottingham City Centre, there may also be opportunities to convert Listed or 'quirky' buildings into more modern office accommodation, although given the additional costs likely to be involved this may require some form of gap funding or other intervention by the public sector to make such schemes commercially viable.

Freeports

- 5.114 The Government is progressing proposals for eight new freeports in England. Freeports are designated areas with little to no tax in order to encourage economic activity. There is a proposed freeport based around the East Midlands Airport and Gateway Industrial Cluster [EMAGIC] in North West Leicestershire, **Uniper's Ratcliffe-on-Soar Power Station site in Rushcliffe Borough**

in Nottinghamshire and the East Midlands Intermodal Park (EMIP) in South Derbyshire. The Government hopes that this will boost investment, increase manufacturing and deliver new jobs.

6.0 Business Survey

Introduction

6.1 This section outlines the findings from the online Business Survey which was undertaken by Lichfields in November / December 2020 and into January 2021 to gain a better understanding of local companies' current and future employment space needs. The survey was sent to contacts recorded by the 8 Councils in their business databases. The Survey obtained responses from 76 businesses across a range of sectors and locations in the study area. It is accepted that due to the comparatively small response size it is difficult to draw definitive conclusions regarding Nottingham Core-Outer HMA's business needs from this source alone.

Business Survey Results

Profile of Businesses

6.2 Of the 76 respondents, 16 are retail businesses, 6 are in creative/digital media, 1 is in construction, 4 are in legal and accounting services, 3 are in financial services, 14 are in hospitality and tourism, and 10 are in other professional services. Other respondents included hairdressers and beauty salons, a tattoo studio and a vehicle finance broker.

6.3 22 respondents are sole traders whilst a further 39 have fewer than 9 employees. 8 respondents are small sized (with between 10 and 49 employees). The highest number of employees amongst respondents is 375. As shown in Table 6.1, the profile of businesses surveyed is very similar to that of the overall study area, with slightly more medium and large businesses surveyed.

Table 6.1 Business Survey Size Profile

	Business Survey Respondents		Nottingham Core HMA		Nottingham Outer HMA	
Micro (0 to 9)	61	81.3%	22,330	88.47%	9,430	88.01%
Small (10 to 49)	8	10.6%	2,330	9.23%	1,045	9.75%
Medium (50 to 249)	4	5.3%	430	1.70%	195	1.82%
Large (250+)	2	2.6%	145	0.57%	45	0.42%
Total	75*	100.0%	25,240	100.0%	10,715	100.0%

Source: Lichfields Analysis / ONS (2020) Business Counts

*Note: 1 respondent did not provide their employment figures.

6.4 As shown in Figure 6.1, a majority of respondents stated that their staff predominantly commute to work either from within the Borough/District that they are located, or elsewhere within Nottinghamshire or Derbyshire County. In terms of supply, 22 respondents stated they sourced from suppliers at a national level, compared to just 12 who stated their suppliers were based within the Borough/District. 25 businesses stated that a majority of their customers are within the Borough/District that they are located, with 29 also outlining that the majority of their competitors are situated locally too.

6.5 This shows the need for planning policies (and corporate functions) to value and support the key role that smaller businesses are playing locally and the need to

invest in and value these local connections, particularly given the current economic uncertainty.

6.6 Given the current economic uncertainty surrounding the terms of the Brexit deal, it is perhaps a positive that only 10 of the companies surveyed relies on the majority of its supply chain coming from abroad.

Figure 6.1 Q5: Where are the majority of your suppliers / customers/staff/competitors from?

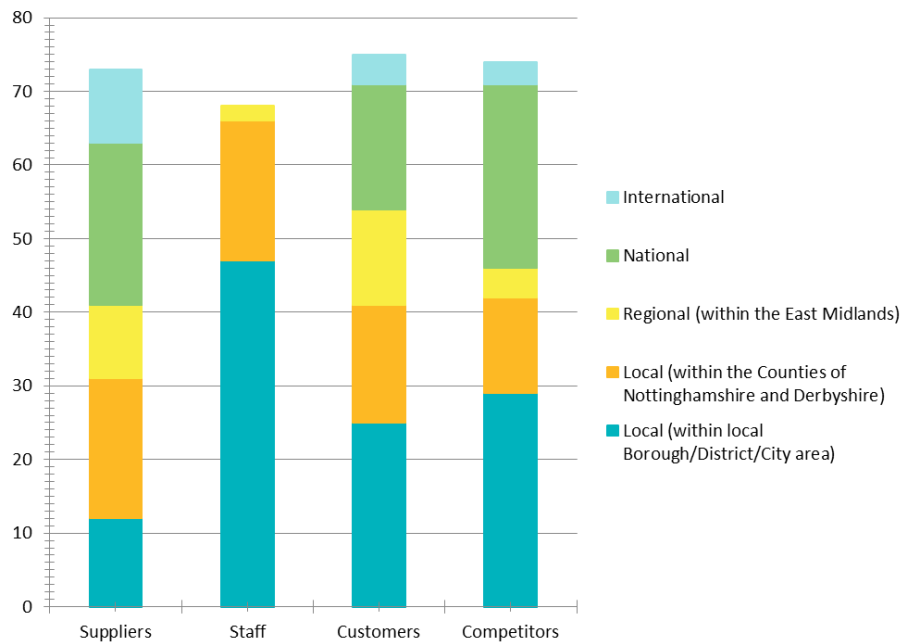

Source: Nottingham Core/Outer HMA Business Survey 2020 / Lichfields Analysis

Business Premises and Location

6.7 Of the 76 respondents, 30 operate from individual urban sites (such as high street shops); 17 operate from town centre offices; 14 operate from home; and, 5 operate from an office/business park. The remaining 10 operate from either industrial estates, managed workspaces, live/work units or rural business units.

Figure 6.2 Q7: How long have you been based at your current premises?

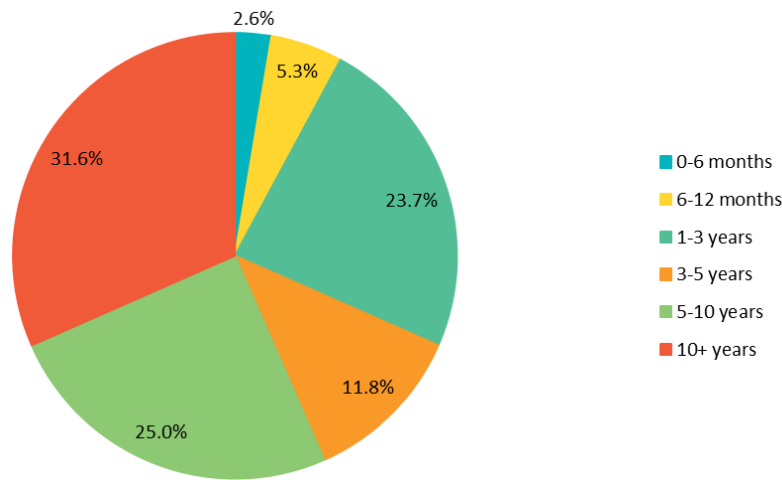

Source: Nottingham Core/Outer HMA Business Survey 2020 / Lichfields Analysis

- 6.8 The majority of respondents have long-standing ties to the District, with 24 businesses (31.6% of the total) having been at their current premises for over ten years. 19 businesses had been at their premises for 5-10 years, 9 for 3-5 years and 18 for 1-3 years. 2 respondents had been at their current premises for less than 6 months. 31 businesses had moved premises at some point since they had started operation, with 16 of those having moved from elsewhere in Nottinghamshire/Derbyshire, and 17 moving from outside the East Midlands.
- 6.9 When asked which factors were most important when selecting their current premises and location, 47 respondents (63.5%) indicated that the cost of premises is the most important factor influencing decision making (rating it a 4 or 5 for importance), followed by the quality of the premises (62.2%), running costs (50.0%) and the proximity to client base (48.7%). Security was also deemed important (47.3%), with flexibility (32.4%) and ICT (24.3%) deemed less important.

Figure 6.3 Q10: Did any of the following factors influence the selection of your current premises? (1 = least important, 5 = most important)

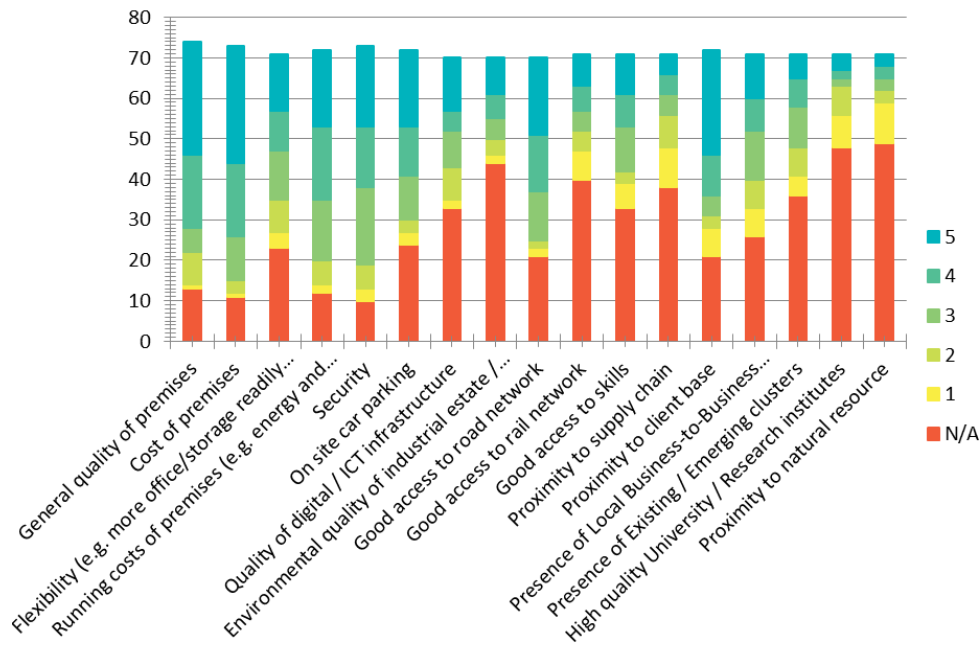

Source: Nottingham Core/Outer HMA Business Survey 2020 / Lichfields Analysis

6.10 75.0% of respondents reported that their current premises were adequate in terms of size, whilst 21.1% reported a lack of available space and 3.9% reported that their premises were underutilised. Similarly, 57.9% also indicated that their premises and site were of good to excellent quality (a rating of 4 or 5), whilst 3.9% reported them to be poor (a rating of 1 or 2).

6.11 When asked to provide further details, those respondents less satisfied with their premises and site mentioned a general need for refurbishment, with many of the buildings described as old and in need of updating.

Figure 6.4 Q12: How would you rate the quality of your buildings and site? (1=poor, 5=excellent)



Source: Nottingham Core/Outer HMA Business Survey 2020 / Lichfields Analysis

Business Impact of Covid-19

6.12 In terms of the overall impacts of Covid-19 and the lockdown on their business, 88.1% of respondents indicated that it had had a negative effect, with 35.5% indicating that it was having a major negative effect on their business and the 6.6% of respondents stating it was having a positive effect and 3.9% a minor positive effect.

6.13 When asked for more detail regarding these effects; 75.0% of businesses indicated a negative effect on demand; 50.0% reported cashflow issues; 23.7% reported negative supply-side effects; 50.0% reported cancellations of events and 5.3% reported issues with increased sick pay. 48.7% of respondents stated that business operations were still temporarily shut down at the time of the survey. When asked about staffing, 31.6% of respondents reported that they had furloughed over 50% of their workforce, whilst 50.0% had not furloughed any staff.

Future Requirements

6.14 Businesses were also asked what changes they might make to their businesses once Covid-19 restrictions are lifted. 26.3% indicated that they would increase the amount of home and remote working; 28.9% stated that they would seek to diversify the business; 25.0% said that they would allow greater flexibility in staff working patterns; and 19.7% stated that they would look to retrain/upskill their workforce.

6.15 36 businesses (47.4%) stated that they would seek to move or make changes to their premises over the next five years. Of these businesses, 14 require more space, whilst 22 require less space due to downsizing or changing requirements. One of the businesses requiring less space due to changing requirements gave

the reason that increased working from home will mean offices will be used more as meeting/social hubs in the future. In light of the Covid-19 pandemic, we might have expected that some businesses would be looking to downsize their current premises whilst maintaining the same number of staff due to increased levels of home working. However, this was not an apparent trend within the survey responses.

6.16 Following on from this question, when asked about the most likely outcome, 17 respondents said that they would look to relocate to another site in the same town/location, with 13 respondents stating they would most likely adapt their current site.

Figure 6.5 Q21: How satisfied are you with your local area as a business location? (1=very dissatisfied, 5=very satisfied)

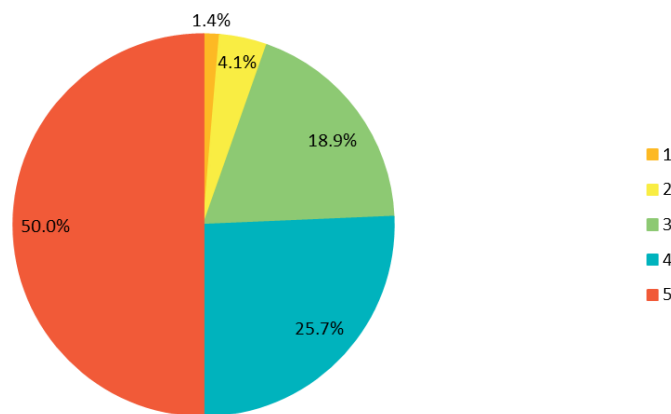

Source: Nottingham Core/Outer HMA Business Survey 2020 / Lichfields Analysis

6.17 Overall, 75.7% of respondents rated their satisfaction with their local area as a business location 4 or 5 out of 5. Positive reasons given include the sub-region’s central national geography and excellent transport links. Only 5.5% of respondents rated their local area a 1 or 2 out of 5.

6.18 When asked about the advantages of their current location, 24 businesses outlined the benefits of their location for client base and staff, as well as the transport access. Many respondents noted the strong connection between their business and the client base, with 2 respondents highlighting the ‘supportive local community’ that benefit their businesses.

6.19 In terms of disadvantages of the study area as a business location, 4 respondents raised issues with lack of footfall. 2 businesses raised the issue of inadequate parking in their location and one business suggested that rental levels were too high even on properties away from the recognised high street.

6.20 When asked about future priorities for the Council a number of issues were raised. Many respondents outlined the need to develop underutilised space such as brownfield land whilst also stressing the need to take into account changing working practices and the lack of demand now for large scale office blocks. A number of respondents mentioned the need for better parking, whilst others called for improvements to urban green space and increased pedestrianisation.

7.0 **Stage 2) Review of Strategic Employment Sites Portfolio**

Introduction

- 7.1 This section presents the findings from the employment land site assessments and considers the spatial characteristics and quality of the existing and allocated sites across the 8 authorities and their suitability to meet future office, industrial and distribution development needs and their likely deliverability.
- 7.2 In consultation with the constituent Councils it was agreed that the assessment should focus on sites that are either currently in existing employment or other uses, or allocated for employment use within the adopted development frameworks. To reflect the NPPF, the assessment has re-appraised previously allocated land, looking carefully at sites which have failed to attract development.
- 7.3 We have not been asked to appraise all of the existing employment sites across the 8 districts; this will form a second stage assessment to be undertaken by Council Officers and will generally focus on smaller industrial sites and business parks. The focus of this study has been on the appraisal of the largest strategic employment sites in the sub-region, identified for appraisal by Council Officers and generally coming from the following key sources:
- 1 Local Plan Allocations; designated employment sites under policies in the respective Council's adopted local development frameworks;
 - 2 Extant planning permissions: other sites with extant planning permission (i.e. permissions that have not yet expired and could be implemented) for employment development (as at November 2020); and
 - 3 D2N2 Vision 2030 Strategic Economic Plan.
- 7.4 In total, 133 existing allocated or, in a few instances, potential employment sites, were assessed, amounting to a very substantial 2,925.37 ha of land (gross) across the whole study area. The breakdown of the 133 sites across the districts was as follows:
- Ashfield: 14
 - Broxtowe: 18
 - Erewash: 16
 - Gedling: 7
 - Mansfield: 16
 - Newark & Sherwood: 26
 - Nottingham City: 27
 - Rushcliffe: 9
- 7.5 The location of the assessed sites is presented in a series of district maps in Appendix 2.

Approach

- 7.6 The 133 strategic employment sites were inspected for their suitability for employment use in accordance with the PPG's Housing and Economic Land Availability Assessment guidance⁸¹. This focused on the following criteria:
- 1 Site Context;
 - 2 Local Plan designations / SHLAA status;
 - 3 Planning History;
 - 4 Current Use and Land Type;
 - 5 Current occupier profile (if partly developed) and Net Developable Area;
 - 6 Physical limitations or problems such as strategic road/local access, infrastructure, ground conditions, flood risks, pollution or contamination (where known);
 - 7 Proximity to labour, public transport and services;
 - 8 Potential impacts including the effect upon nature and heritage conservation;
 - 9 Environmental/amenity impacts experienced by would be occupiers and neighbouring areas;
 - 10 Barriers to Delivery, including ownership constraints (if provided by the Commissioning Group, or detailed within adopted planning documents);
 - 11 Appropriateness and likely market attractiveness (including vacancy and market activity on site) for the type of development proposed; and
 - 12 Strategic Fit with the Growth Area Objectives (particularly the site's fit with the industrial market growth sectors targeted by D2N2).
- 7.7 Although flood risk was considered as part of the assessments, it is recognised that being in a flood zone does not necessarily preclude some types of commercial uses from coming forward for development.
- 7.8 Alongside site visits undertaken by Lichfields, the analysis was supplemented by discussions with key stakeholders such as commercial agents and Council Officers. The assessments also reviewed data provided by Council Officers such as contamination, natural and historic environment factors, and relevant planning history.
- 7.9 Lichfields has not undertaken detailed site viability analysis or been provided with details regarding land ownership for most sites. The site assessments were based on site observations and desk-based analysis from publicly available data.
- 7.10 The assessment of gross site areas to net developable areas was based upon the following sources:
- 1 Details provided within the relevant planning history/allocation;
 - 2 Adjustments based on site specific factors (for example if steep topography further limited the net developable areas); and/or

⁸¹ PPG: 3-015-20190722

3 A standardised plot adjustment, using the ‘rule of thumb’ parameters as set out in Appendix 3.

- 7.11 Sites that were fully developed were given a net developable area of 0 (nil) ha. Fully developed sites recommended as being suitable for employment use do not contribute to the future employment land supply.
- 7.12 Information from the site visits and desk-based analysis was collated into a standardised pro-forma, together with comments written against each criterion (as listed above). The individual proformas for the assessed sites are included in Appendix 4, which also provides photographs, red-line boundaries on aerial maps, the final rating and recommendation for each site.
- 7.13 To allow for comparison between the sites the respective assessment criterion were ranked along a scale rating (between ‘Very Poor’, ‘Poor’, ‘Average’, ‘Good’ and ‘Very Good’) with a final and overall site rating awarded. The full ‘Strategic Site Assessment Criteria’ to which the respective criteria have been assessed is provided in Appendix 5.
- 7.14 The outcome of the assessment has enabled Lichfields to recommend which sites should be prioritised, safeguarded, retained for employment uses and which could be considered for release. Where appropriate, recommendations were also included for upgrading / expansion / renovation to a site.
- 7.15 It should be noted that the assessment process in itself does not necessarily provide a complete picture of the local significance of certain sites. For example, a site could be assessed to have the potential to satisfy particular business and sector needs (i.e. which can be important reasons for retaining the site) even if it does not perform well against conventional site assessment criteria. A wider commentary is therefore provided to supplement the formal rating exercise.
- 7.16 Accordingly, the assessment is also informed by factors such as market intelligences, market attractiveness and compliance with planning policy. Greater weight has been given to sites which best respond to the market’s needs and where any identified constraints can be overcome with appropriate mitigation through the planning process. A site, for example, could be considered as having the potential of satisfying particular business or sector needs (which can be important reasons for retaining it, even if it does not perform well against conventional site assessment criteria).
- 7.17 Similarly, sites with significant known impediments / constraints (such as contamination, or subject to significant flood risk) have been downgraded. If any site constraints were to be removed in the future (i.e. policy constraints, access improvements, site contamination / remediation), the scoring of the site would likely improve.
- 7.18 It is also important to note that the assessments are based on the conditions and data observed during the timescales of the study. The site visits were conducted during November and December 2020, such information is clearly time-sensitive and may change in the future. The intrinsic qualities of sites and the associated ratings have been derived on the basis of assessment. It is possible that the relative rankings of sites could change in the future if measures were

put into place to enhance their functioning as employment sites (for example through new infrastructure and servicing).

- 7.19 The assessment provided in the following sections is presented on a ‘without prejudice’ basis as evidence to inform the Nottingham Core HMA’s review of the Aligned Core Strategies and preparation of new Part 1 Local Plans, but also the Nottingham Outer HMAs Local Plan Reviews in due course.

Site Assessment Results

- 7.20 The final recommendation for each site is informed by the site assessment and commentary (in Appendix 4) but is essentially based on a rounded qualitative judgement which reflects a detailed consideration of the following key issues:
- 1 **Sustainability** – whether a site demonstrates characteristics that make it sustainable, such as being: previously developed land; accessible by public transport; compatible with neighbouring uses; and in an area at a lower risk of flooding;
 - 2 **Market Attractiveness** – whether a site is: likely to be commercially attractive from a developer’s perspective (taking into account the possible need for site remediation, levelling and off-site and on-site infrastructure work); in an area of strong demand; and likely to be viewed as attractive by agents/occupiers;
 - 3 **Policy Adherence** – whether there are any known policy constraints affecting the site or immediate surrounding area. These may relate to the natural built and/or historic environment, such as whether the site lies within the Green Belt.

Nottingham Core HMA

- 7.21 Overall the assessments of existing sites indicate that across the 77 Core HMA sites assessed, there is a strong supply of employment sites that vary in their scale and provision of facilities to satisfy their occupiers’ needs: from City Centre sites, to traditional industrial estates, modern office accommodation and rural sites for niche (generally indigenous) uses. The majority of the sites assessed accommodated a mix of office, light industry, B2 and B8 uses.
- 7.22 In respect of Broxtowe, Erewash and Gedling, the majority of employment sites within these districts have been fully developed whilst a notable number of the Nottingham City sites also reflect this trend. However, there are several employment sites across these districts with net developable space remaining which have development potential. Notable examples include:
- **Erewash:** Stanton Regeneration site (21.98 ha);
 - **Gedling:** Top Wighay Farm (6.5ha), Gedling Colliery/Chase Farm (2.45 ha), Colwick Industrial Estate (5.5 ha) and Teal Close (6.45 ha);
 - **Nottingham City:** Canal Quarter – Island Site (7.02 ha), Riverside/Lenton Lane (Boots/Abbeyfield Road – Boots Site (13.97 ha), Riverside/Lenton Lane (Abbeyfield Road – East of Beeston Canal) (6.77 ha), Riverside/Lenton Lane (former Wilford Power Station)/Lenton Lane- Lenton Lane (5.57 ha);

- **Rushcliffe:** Land North of Bingham (14.16 ha), RAF Newton (10.67 ha), Ratcliffe-on-Soar Power Station (206.81 ha) and East of Gamston (12 ha).

Table 7.1 Core HMA Site Scoring Summary

Site Score	Number of Sites	Size (ha) net
Very Good	12	25.54
Good/Very Good	1	0.15
Good	37	296.47
Average/Good	2	0
Average	14	48.12
Poor/Average	8	22.78
Poor	3	0
Total	77	393.6

Source: Lichfields Analysis

7.23

In Table 7.2, the green shading in the final column relates to those sites where Lichfields recommends that the site should retain its current designation/protection for employment use. Amber shading denotes a recommendation for a site to be designated as mixed use with an element of employment uses, or an amendment to the site boundary to reduce the size of the site to reflect the encroachment of non-employment uses. A red shading reflects a recommendation for that site either to be released from employment to alternative uses, or for it not to be allocated for employment use in the first place.

Table 7.2 Summary of Core HMA Site Assessments for 2021 ELS

Site Reference	Local Authority	Site Name	Size (net developable land remaining, ha)	Site Rating	Recommendation
BBC 1	Broxtowe	Chilwell Meadows Business Park	0	Good	Protect for employment uses Retain current Local Plan Part 2 designation as an employment site
BBC 2	Broxtowe	Eldon Road Business Park	0	Good	Protect for employment uses Retain current Local Plan Part 2 designation as an employment site
BBC 3	Broxtowe	Gin Close Way	0	Average	Protect for employment uses Retain current Local Plan Part 2 designation as an employment site
BBC 4	Broxtowe	Beeston Business Park (1)	0	Very Good	Protect for employment uses Retain current Local Plan Part 2 designation as an employment site
BBC 5	Broxtowe	Beeston Business Park (2)	0	Very Good	Protect for employment uses Retain current Local Plan Part 2 designation as an employment site
BBC 6	Broxtowe	Padge Road, Boulevard	0	Good	Protect for employment uses

Site Reference	Local Authority	Site Name	Size (net developable land remaining, ha)	Site Rating	Recommendation
		Industrial Park			Retain current Local Plan Part 2 designation as an employment site
BBC 7	Broxtowe	Lilac Grove	0	Good	Protect for employment uses Retain current Local Plan Part 2 designation as an employment site
BBC 8	Broxtowe	Boots Campus	0	Very Good	Protect for employment uses Retain current Local Plan Part 2 designation as an employment site
BBC 9	Broxtowe	Cossall Industrial Estate	0	Average	Protect for employment uses Retain current Local Plan Part 2 designation as an employment site
BBC 10	Broxtowe	Meadowbank Court	0	Good	Protect for employment uses Retain current Local Plan Part 2 designation as an employment site
BBC 11	Broxtowe	Moorgreen Colliery Site, Engine Lane	0	Average	Protect for employment uses Retain current Local Plan Part 2 designation as an employment site
BBC 12	Broxtowe	Phoenix Park	0	Very Good	Protect for employment uses Retain current Local Plan Part 2 designation as an employment site
BBC 13	Broxtowe	Palmer Drive and Bessell Lane	0	Average	Protect for employment uses Retain current Local Plan Part 2 designation as an employment site
BBC 14	Broxtowe	Main Road, Fernwood Drive, Common lane and British Bakeries Ltd.	0	Good	Protect for employment uses Retain current Local Plan Part 2 designation as an employment site
BBC 15	Broxtowe	Beeston Business Park	0	Good	Protect for employment uses Retain current Local Plan Part 2 designation as an employment site
BBC 16	Broxtowe	Boots Campus	2.52	Good	Allocate for employment uses Retain current Local Plan Part 2 designation as an existing employment commitment
BBC 17	Broxtowe	Nottingham 26	1.51	Good	Allocate for employment uses Retain current Local Plan Part 2 designation as an employment commitment
BBC 18	Broxtowe	Aero Fabrications	0.44	Good	Allocate for Employment Uses Retain its current protection as an

Site Reference	Local Authority	Site Name	Size (net developable land remaining, ha)	Site Rating	Recommendation
					employment site
EBC 1	Erewash	Chemring Defence Campus	0	Poor	Protect for employment uses (For specialised employment use)
EBC 2	Erewash	Forbes Close Industrial Estate	0	Good	Protect for employment uses
EBC 3	Erewash	Acton Road Industrial Estate	0	Good	Protect for employment uses
EBC 4	Erewash	Fields Farm Industrial Estate	0	Good	Protect for employment uses
EBC 5	Erewash	West Hallam Storage Depot	0	Poor	Consider releasing for alternative uses
EBC 6	Erewash	Stanton Regeneration	21.98	Average / Poor	Designate for mixed-use with element of employment uses (i.e. retain current Policy 20: Stanton Ironworks Regeneration)
EBC 7	Erewash	Progress Rail	0	Good	Protect for employment uses
EBC 8	Erewash	Quarry Hill Industrial Estate	0.15	Good / Very Good	Allocate for employment uses
EBC 9	Erewash	Crompton Road Industrial Estate	0	Good	Protect for employment uses
EBC 10	Erewash	Little Eaton Southern Triangle	0	Poor	Do not allocate
EBC 11	Erewash	Hallam Fields Industrial Estate	0	Good	Protect for employment uses
EBC 12	Erewash	Furnace Road Industrial Estate	0	Average	Protect for employment uses
EBC 13	Erewash	Digby Street Industrial Estate	0.49	Average / Poor	Allocate for employment uses
EBC 14	Erewash	Manners Industrial Estate	0	Very Good	Protect for employment uses
EBC 15	Erewash	Great Bear Industrial Estate	0	Average	Protect for employment uses
EBC 16	Erewash	Stanton Bonna Concrete Plant and Works	0	Average	Protect for employment uses
GBC 1	Gedling	Top Wighay Farm	6.5	Good	Designate for mixed-use with element of employment use (i.e. retain current strategic allocation with a substantial element of E/B8 employment land)

Site Reference	Local Authority	Site Name	Size (net developable land remaining, ha)	Site Rating	Recommendation
GBC 2	Gedling	Gedling Colliery/Chase Farm	2.45	Very Good	Designate for mixed-use with element of employment use (i.e. retain current Local Plan Part 2 designation as an employment-led mixed-use designation)
GBC 3	Gedling	Colwick Industrial Estate	5.5	Average	Allocate for employment (i.e. retain current Local Plan Part 2 designation (Policy LPD 44) for employment uses)
GBC 4	Gedling	Victoria Business Park	1.1	Good	Allocate for employment (i.e. retain current Local Plan Part 2 designation (Policy LPD 44) for employment uses)
GBC 5	Gedling	Salop Street	0	Average/Good	Protect for employment (i.e. retain current Local Plan Part 2 designation (Policy LPD 44) for employment uses)
GBC 6	Gedling	Brookfield Road	0	Average	Protect for employment (i.e. retain current Local Plan Part 2 designation (Policy LPD 44) for employment uses)
GBC 7	Gedling	Teal Close	6.45	Very Good	Designate for mixed-use with element of employment use (i.e. retain current strategic allocation for employment uses)
NCC1	Nottingham City	Glaisdale	2.93	Good	Allocate for employment uses Retain current Local Plan designation as a major business park/industrial estate
NCC2	Nottingham City	Blenheim	7.05	Good	Allocate for employment uses Retain current Local Plan designation as a major business park/industrial estate
NCC 3	Nottingham City	Phoenix Park	0	Very Good	Protect for employment uses Retain current Local Plan designation as a major business park/industrial estate
NCC 4	Nottingham City	Greasley Street	0	Average/Poor	Protect for employment uses Retain current Local Plan designation as a major business park/industrial estate
NCC 5	Nottingham City	Nottingham Science and Technology Park	0	Very Good	Protect for employment uses Retain current Local Plan designation as a major business park/industrial estate
NCC 6	Nottingham	Stanton Tip – Hempshill	31.95	Average	Designate for mixed-use with element of employment use (i.e. retain current Local

Site Reference	Local Authority	Site Name	Size (net developable land remaining, ha)	Site Rating	Recommendation
	City	Vale			Plan designation as a development site)
NCC 7	Nottingham City	Canal Quarter – Island Site	7.02	Good	Designate for mixed-use with element of employment use (i.e. retain current Local Plan designation as a development site)
NCC 8	Nottingham City	Waterside – Freeth Street	0	Poor/Average	Protect for mixed-use with element of employment use (i.e. retain current Local Plan designation as a development site)
NCC 9	Nottingham City	Haydn Road/Hucknall Road	0	Good	Do not allocate the site for employment uses
NCC 10	Nottingham City	Arnold Road/Rani Drive	0	Average	Protect for employment uses Do not Allocate the site as a major business/industrial estate
NCC 11	Nottingham City	Bar Lane Industrial Estate, Basford Road	0.11	Average/Poor	Allocate for employment uses
NCC 12	Nottingham City	Bar Lane/ East of Percy Street	0.20	Average/Poor	Allocate for employment uses Amend the site boundary to exclude non-employment uses
NCC 13	Nottingham City	Carlton Road / Stonebridge Road	0	Average	Protect the site for employment uses / mixed-use
NCC 14	Nottingham City	Nottingham Business Park	2.0	Good	Allocate for employment uses Amend the site boundary to exclude the residential/retail areas and allocate the remainder of the site as a major business/industrial estate
NCC 15	Nottingham City	Queens Drive	0	Good	Protect the site for employment uses/ mixed-use
NCC 16	Nottingham City	Riverside/ Lenton Lane (Boots/Abbeyfield Road – Boots Site)	13.97	Very Good	Allocate for employment uses Retain current Local Plan designation as a major business/industrial estate
NCC 17	Nottingham City	Riverside/ Lenton Lane (Abbeyfield Road – East of Beeston Canal)	6.77	Good	Allocate for employment uses Retain current Local Plan designation as a major business/industrial estate
NCC 18	Nottingham City	Riverside/ Lenton Lane (Abbeyfield Road – Harrimans Lane Area)	0	Good	Protect for employment uses Retain current Local Plan designation as a major business/industrial estate
NCC 19	Nottingham City	Riverside /Lenton Lane (former Wilford Power Station) - Lenton Lane	5.57	Good	Allocate for employment uses Retain current Local Plan designation as a major business/industrial estate
NCC 20	Nottingham City	Riverside/ Lenton Lane (former Wilford Power Station/Lenton Lane –	0	Good	Protect for employment uses Retain current Local Plan designation as a

Site Reference	Local Authority	Site Name	Size (net developable land remaining, ha)	Site Rating	Recommendation
		Queens Drive Industrial Estate			major business/industrial estate
NCC 21	Nottingham City	New Basford Industrial Estate (Mount Street/Duke Street)	0	Average/Poor	Protect for employment uses Amend the site boundary to exclude the residential area and protect the remainder of the site as a major business/industrial estate
NCC 22	Nottingham City	New Basford Industrial Estate (Radford Rd/North Gate)	0	Average/Poor	Protect for employment uses Retain current Local Plan designation as a major business/industrial estate
NCC 23	Nottingham City	NG2 Business Park	2.72	Very Good	Allocate for employment uses Retain current Local Plan designation as a major business/industrial estate
NCC 24	Nottingham City	Castle Quarter	0	Good	Protect the site for employment uses/ mixed-use (i.e. retain current Local Plan designation as the Castle Quarter)
NCC 25	Nottingham City	Creative Quarter	0.094	Good	Protect the site for employment uses/ mixed-use (i.e. retain current Local Plan designation as the Creative Quarter)
NCC 26	Nottingham City	Canal Quarter	0	Good	Protect the site for employment uses/ mixed-use (i.e. retain current Local Plan designation as the Canal Quarter)
NCC 27	Nottingham City	Royal Quarter	0	Good	Protect the site for employment uses/ mixed-use (i.e. retain current Local Plan designation at the Royal Quarter)
RBC 1	Rushcliffe	Land north of Bingham	14.16	Good	Allocate for employment uses (i.e. retain current Local Plan Part 1 strategic allocation 'Land North of Bingham' designation.)
RBC 2	Rushcliffe	RAF Newton	10.67	Average	Allocate for employment uses (i.e. retain current Local Plan Part 1 strategic allocation for employment uses as part of a wider mixed-use development)
RBC 3	Rushcliffe	Ruddington Fields Business Park	0	Very Good	Protect for employment uses
RBC 4	Rushcliffe	Ratcliffe-on-Soar Power Station	206.81	Good	Allocate for employment uses – the site is suitable for research & development uses located adjacent to the East Midlands Parkway Railway Station, science park and advanced manufacturing uses on the site south of the A453 and more energy-intensive low-carbon technology industries on the site

Site Reference	Local Authority	Site Name	Size (net developable land remaining, ha)	Site Rating	Recommendation
					north of the A453. It is part of the East Midlands Airport Freeport, one of 8 designated by the Government in its March 2021 Budget with the aim of reducing administrative burdens and tariff controls, provide relief from duties and import taxes, and ease tax and planning regulations.
RBC 5	Rushcliffe	East of Gamston	12	Good	Allocate for employment uses Retain current Local Plan Part 1 strategic allocation to protect proposed employment space.
RBC 6	Rushcliffe	Land South of Clifton	20	Good	Allocate for employment uses Retain current Local Plan Part 1 strategic allocation to protect proposed employment space.
RBC 7	Rushcliffe	Moorbridge Industrial Estate	0	Average / Good	Protect for employment uses Retain current Local Plan Part 1 strategic allocation 'Land North of Bingham' designation in the eastern portion of the site and protect the remainder of the site for employment uses.
RBC 8	Rushcliffe	British Gypsum	0	Average	Protect for employment uses
RBC 9	Rushcliffe	British Geological Survey	0	Good	Protect for employment uses

7.24 Of the total number of sites assessed, 74 were considered suitable for employment use and therefore recommended to be protected for such uses. This totals a **net area of 393.06 ha**, although not all of this will come forward for office/industrial/distribution floorspace in isolation as some may come forward for a mix of uses of which employment may only be a component part.

7.25 **This included all 7 strategic sites that were assessed within Gedling (21.95 ha, net); all 18 in Broxtowe (4.47 ha, net); 14 for Erewash (22.62 ha, net); 26 for Nottingham City (80.384 ha net) and all 9 of the strategic sites that were assessed in Rushcliffe (263.64 ha net).**

7.26 The vast majority of the sites were rated either 'very good', 'good' or 'average'. Despite a few of the sites appraised having some constraints either due to policy, ownership or physical issues, they generally fulfil wider employment functions and justified being retained as a result of their proximity to existing major road networks, high occupancy levels and/or providing employment accommodation for growth, niche or local businesses.

- 7.27 The tables above include recommendations for sites which are considered to be suitable for mixed use sites with an element of employment space. These sites comprise the following;
- GBC2 Gedling Colliery/Chase Farm (Gedling);
 - NCC13 Carlton Road/Stonebridge Road (Nottingham City).
- 7.28 It should be noted that Carlton Road/Stonebridge Road was also considered to be of a much smaller scale compared to the other Nottingham City sites and served a more localised need. The site therefore merited an alternative designation as arguably it does not constitute a ‘Major Business Park/Industrial Estate’. Our recommendation is that whilst it should retain a degree of employment protection, this should be at a slightly lower level reflecting the much smaller scale of the site (with the reference being simply to ‘Protect for Employment Uses’).
- 7.29 Similarly, there are several sites within Nottingham City which are recommended to have their site boundaries amended, for the following reasons:
- 1 **NCC12 Bar Lane/Radford Road** (Nottingham City): the site contains several residential properties pepper-potted throughout. A new application for residential development (with an element of retail/commercial at ground floor) was approved in January 2020 (ref. 18/01382/PFUL3) indicating a progression towards additional residential development in the site. It was recommended that the site boundary should be reviewed to exclude non-employment uses and specifically the residential properties where practical.
 - 2 **NCC14 Nottingham Business Park** (Nottingham City): the site has been developed as a purpose-built mixed-use development. The Business Park is clearly separated from the large residential neighbourhood to the south and ancillary retail. It was recommended that the boundary of the Park should be reviewed to exclude the non-employment uses.
 - 3 **NCC21 New Basford Industrial Estate (Mount Street/Duke Street)** (Nottingham City): the former Guy Birkin Lace premises occupying a derelict factory has permission for residential development (ref. 14/00712/PFUL3) (unimplemented). The factory is slightly removed from the main industrial estate and immediately borders other residential areas and therefore it was recommended that it should be excluded from the designated employment boundaries.
- 7.30 There are 41 sites which have now been fully built out and therefore do not have any net available land. However, it is considered that these sites should still be retained for employment uses and protected going forward given that the sites are occupied by employment uses and generally fulfil important local employment functions. This includes: 13 sites within Broxtowe; 11 in Erewash; 2 in Gedling; 11 in Nottingham City; and 4 in Rushcliffe.
- 7.31 There are three sites which Lichfields considers are not suitable to specifically protect for employment use. These include two within Erewash and one within Nottingham City, for the following reasons:
- 1 **NCC9 Haydn Road/Hucknall Road** (Nottingham City): Although the site contains a number of local businesses, many of the site’s occupants are

not typical commercial/industrial uses such as yoga and art studios, a school and religious premises. The occupation of a Gymnastics Club within the site, adjacent to a Drilling Training Centre also indicates a further shift away from the traditional industrial uses of the site.

- 2 **EBC5 West Hallam Storage Depot** (Erewash): The depot is an established site hosting a mix of occupiers such as XPO Logistics, Highways England and Murphy Young Caravan Space. However, the site scored poorly in many of the assessment criteria (such as strategic road access, proximity to urban areas and services, development and environmental constraints, barriers to delivery and mitigation and strategic fit with growth area). In addition, there is concern the Romney units across the site becoming less economically viable with age and restrictions on operation at the site no longer accord with the 24-hour requirements of e-commerce and last mile logistics. It was therefore recommended that the Council considers releasing this site for alternative uses, although the potential economic impact of a change of use of this large site should not be under-estimated. The Council would need to consider/help to facilitate occupiers relocating to more suitable and accessible locations elsewhere in the Borough. This will require careful consultation with existing occupiers of the site.
- 3 **EBC10 Little Eaton Southern Triangle** (Erewash): the site is in use by two occupants only; Blue Diamond Garden Centre and a water treatment facility. The water treatment works is a bespoke infrastructure facility that could not easily be converted, whilst the Garden Centre provides local employment. Given that neither fulfil traditional industrial / commercial employment uses the site should not be allocated for industrial / distribution / office use.

Nottingham Outer HMA

- 7.32 The assessments of 56 strategic employment sites across the 3 Outer HMA districts indicates that Ashfield, Mansfield and Newark & Sherwood collectively have a reasonable supply of employment sites of varying quality and type. Most of the sites assessed accommodated a mix of E, B2 and B8 uses.
- 7.33 The majority of employment sites within Ashfield and Mansfield districts have been developed with the (notable) exceptions of: Harrier Park in Ashfield; a mixed-use development at Rolls-Royce in Hucknall; an extension/new site in the vicinity of Sherwood Business Park; part of the Potential New Settlement Site between Pinxton Lane & Kirkby Road; Rushley Farm off the A60, Sutton in Ashfield and Penniment Farm (Mansfield) which is part of a wider development with the site allocated for a minimum of 9 ha of employment uses. The grading of employment sites in Newark and Sherwood is more mixed; however, there are some sites here with substantial development potential including: Newark Industrial Estate (including the 16 ha G Park logistics/warehouse development opportunity), Land North and South of Cross Lane; Land north of the A17; Land west of the A1 on Stephenson Way; Land south of Newark (NAP 2A); Land around Fernwood (NAP 2C) and the Former Clipstone Colliery.
- 7.34 A summary of site rankings is provided in Table 7.3, with a summary of the site assessments in Table 7.4.

Table 7.3 Outer HMA Site Scoring Summary

Site Score	Number of Sites	Size (ha) net
Very Good	7	49.22
Good	22	101.6
Average	19	52.49
Average / Poor	4	15.41
Poor	4	30.57
Total	56	249.29

Source: Lichfields Analysis

Table 7.4 Summary of Outer HMA Site Assessments

Site Reference	Local Authority	Site Name	Size (net developable ha)	Site Rating	Recommendation
ADC 1	Ashfield	Summit Park, Sherwood Way South	1.9	Very Good	Allocate for employment uses Retain current employment designation
ADC 2	Ashfield	Harrier Park	20	Very Good	Allocate for employment uses, with the exception of land proposed for residential development under pending planning application ref. V/2020/0553 to the south east of the Rolls-Royce plant.
ADC 3	Ashfield	Lowmoor Business Park	0	Good	Protect for employment uses – the boundary should include the entire employment area.
ADC 4	Ashfield	Oddicroft Lane	2.35	Good	Allocate for employment uses – the boundary should include the entire employment area.
ADC 5	Ashfield	Sherwood Business Park	0	Very Good	Protect for employment uses – the boundary should include the whole Sherwood Business Park including the existing employment allocations.
ADC 6	Ashfield	Park Lane Business Park	1.2	Average	Allocate for employment uses and protect the remainder for employment uses, the boundary should include the whole Park Lane Business Park site.
ADC 7	Ashfield	The County Estate Nunn Brook Road/ Brookside Way	0	Good	Protect for employment uses – the boundary should include the whole County Estate Nunn Brook Road/Brookside Way Industrial Estate
ADC 8	Ashfield	Calladine Business Park	0	Good	Protect for employment uses
ADC 9	Ashfield	Hamilton Road	0	Average	Protect for employment uses (i.e. retain current employment designation)
ADC 10	Ashfield	Common Road, Industrial Estate, Export Drive	5.7	Good	Allocate for employment uses, with the remainder of the site protected for employment uses including the whole Common Road/Export Drive Industrial Estate.

Site Reference	Local Authority	Site Name	Size (net developable ha)	Site Rating	Recommendation
ADC 11	Ashfield	Fulwood Industrial Estate, Fulwood Road	1.52	Good	Allocate for employment uses and protect remainder of site for employment uses – the boundary should include the whole Fulwood Road Industrial Estate. The Fulwood Road North/Fulwood Industrial Estate EM1sf site which is allocated in the Ashfield Local Plan Review should be retained for employment.
ADC12/13	Ashfield	Extension/new site in the vicinity of Sherwood Business Park, Junction 27 M1 Motorway	18.42	Average	<p>Allocate the northern site for employment uses, do not allocate the southern site.</p> <p>It is considered that the northern site is suitable for the provision of employment uses as an extension of the adjacent Sherwood Business Park, subject to demonstration of exceptional circumstances for removal from the Green Belt and overcoming the access issues and other constraints.</p> <p>As the majority of the southern site is substantially impacted by HS2 Safeguarding Land, both in terms of the route and also for a major compound and temporary material stockpile, this would result in a limited developable area. Therefore, it is not suitable for allocation for alternative uses at the current time. However, should the situation with HS2 change and the land is no longer safeguarded then this site could be developed for employment uses subject to addressing the identified constraints.</p>
ADC14	Ashfield	Part of the Potential New Settlement Site between Pinxton Lane & Kirkby Road (B6019), Kirkby-in-Ashfield (by Junction 28 of the M1)	13.58	Average	<p>Allocate for employment uses, also potential for renewable energy infrastructure provision on this site.</p> <p>It is considered that this site is suitable for expansion of the adjacent business park or the provision of renewable infrastructure. This site could come forward as part of the proposed wider new settlement.</p>
ADC15	Ashfield	Rushley Farm off the A60, Sutton in Ashfield	23.26	Poor	<p>Allocate for employment uses, also potential for uses associated with nearby education institutions.</p> <p>It is considered that should the site not be developed for residential uses, it would be most suitable for a high quality business park or uses associated with the nearby colleges, although significant challenges need to be overcome regarding highways access and associated infrastructure.</p>

Site Reference	Local Authority	Site Name	Size (net developable ha)	Site Rating	Recommendation
MDC 1	Mansfield	Old Mill Lane Industrial Estate	0	Average	Protect for employment uses Retain allocation as a key / general employment area
MDC 2	Mansfield	Sherwood Oaks Business Park	3.09	Good	Allocate for employment uses Retain allocation as a key / general employment area
MDC 3	Mansfield	Millennium Business Park	0.51	Good	Allocate for employment uses Retain allocation as a key / general employment area
MDC 4	Mansfield	Oakham Business Park	0	Good	Protect for employment uses Retain allocation as a key / general employment area
MDC 5	Mansfield	Oak Tree Business Park	0	Average	Protect for employment uses Retain allocation as a key / general employment area
MDC 6	Mansfield	Broadway Industrial Estate	0	Average	Protect for employment uses Retain allocation as a key / general employment area
MDC 7	Mansfield	Crown Farm Industrial Estate	4.05	Good	Allocate for employment uses Retain allocation as a key / general employment area
MDC 8	Mansfield	Gateway Off Grove Way	0	Average	Protect for employment uses Retain allocation as a key / general employment area
MDC 9	Mansfield	Ransom Wood Business Park	1.61	Good	Allocate for employment uses Retain allocation as a key / general employment area, some scope for mixed-use.
MDC 10	Mansfield	Bellamy Road Industrial Estate	0	Good	Protect for employment uses Retain allocation as a key / general employment area
MDC 11	Mansfield	Hermitage Lane Industrial Estate	0	Good	Protect for employment uses Retain allocation as a key / general employment area
MDC 12	Mansfield	Maunside, Hermitage Lane	0	Good	Protect for employment uses Retain allocation for employment uses
MDC 13	Mansfield	Ratcher Hill Employment Area and Quarry	3.45	Average	Allocate for employment uses Retain allocation as a key / general employment area to the south, and Ratcher Hill Quarry Employment Area

Site Reference	Local Authority	Site Name	Size (net developable ha)	Site Rating	Recommendation
					(Policy E2a) to the north east
MDC 14	Mansfield	Bleaks Hill	0	Average	Protect for employment uses Retain allocation as a key / general employment area
MDC 15	Mansfield	Quarry Lane	0	Average	Protect for employment uses Retain allocation as a key / general employment area
MDC 16	Mansfield	Penniment Farm	9	Good	Allocate for employment uses Retain allocation for employment uses
NSDC 1	Newark & Sherwood	Newark Industrial Estate includes NSDC3 and NSDC22	23.56	Good	Allocate for employment uses Retain Newark Industrial Estate Policy Area and protect for employment uses.
NSDC 2	Newark & Sherwood	Dixons Mastercare Site	4.45	Very Good	Allocate for employment uses Allocate vacant land for employment uses, with the built-up area of the Mastercare site protected for employment uses
NSDC 3	Newark & Sherwood	Land off Beacon Hill Road (G Park)	16	Good	Allocate for employment uses
NSDC 4	Newark & Sherwood	British Sugar Corporation, Great North Road	5	Average	Allocate for employment uses Protect land occupied by British Sugar for ongoing employment uses and allocate undeveloped land for employment uses
NSDC 5	Newark & Sherwood	Bowbridge Road Policy Area	2.48	Average	Consider releasing for alternative uses
NSDC 6	Newark & Sherwood	Flowserve Pump Division, Hawton Lane	0	Poor	Consider releasing for alternative uses
NSDC 7	Newark & Sherwood	Land North and South of Cross Lane	7.38	Very Good	Allocate for employment uses Retain strategic site allocation (Land around Fernwood – NAP 2C) for use class E office development ⁸²
NSDC 8	Newark & Sherwood	Staythorpe Power Station	5.51	Poor	Do not allocate for employment uses
NSDC 9	Newark & Sherwood	Staunton Works, Alverton Road	1.8	Poor	Do not allocate for employment uses
NSDC 10	Newark & Sherwood	Caledonian, Carlton Works	0	Good	Protect for employment uses
NSDC 11	Newark &	Land off Old Great	0	Average	Protect for employment uses

⁸² However, in reality, it is unlikely that the whole site will come forward for Use Class E office development and there is likely to be an element of mixed-use development, suggested uses are set out in the site assessment. It is not the purpose of this study to determine the split of these uses.

Site Reference	Local Authority	Site Name	Size (net developable ha)	Site Rating	Recommendation
	Sherwood	North Road			
NSDC 12	Newark & Sherwood	Crew Lane Industrial Area, Southwell	2.71 ⁸³	Average / Poor	Protect the developed area of So/E/1 for employment uses; Allocate So/E/2 for employment uses (2.71ha); and consider safeguarding So/E/3 for employment uses, with potential future scope for an element of mixed-use development.
NSDC 13	Newark & Sherwood	Boughton Industrial Estate North	1.2	Average	Allocate for employment uses
NSDC 14	Newark & Sherwood	Boughton Industrial Estate South	3.59	Average	Allocate for employment uses
NSDC 15	Newark & Sherwood	Sherwood Energy Village	2	Very Good	Allocate for employment uses, see below. Allocate sites identified in the Allocations & Development Management DPD (2013) as having planning permission for employment (E PP) within the western site for employment uses; retain the eastern site identified as having planning permission for residential (Ho PP) for residential uses; and protect the recreational space on the central teardrop shaped sites. The small site to west of the central sites should not be allocated, given it has been developed for residential apartments.
NSDC 16	Newark & Sherwood	Murphy Pipelines Ltd	0	Average	Protect for employment uses
NSDC 17	Newark & Sherwood	Kirton Brick Works, Main Street	0	Average / Poor	Retain designation as a permitted site for the extraction of minerals (brick clay). Do not allocate for office/industrial or distribution uses. It is the responsibility of the County Council to make any changes any to this allocation (Publication Version of the draft Nottinghamshire Minerals Local Plan allocation number: MP6a).
NSDC 18	Newark & Sherwood	Belle Eau Park	1.9	Average / Poor	Allocate for employment uses
NSDC 19	Newark & Sherwood	Blidworth Industrial Park	0.33	Average	Allocate for employment uses Protect remaining site for employment uses and retain existing allocations within that overall designation
NSDC 20	Newark & Sherwood	Land North of the A17	6.32	Good	Designate for mixed-use with an element of employment use.

⁸³ The net developable area has been reduced as per the recommendations in the pro forma.

Site Reference	Local Authority	Site Name	Size (net developable ha)	Site Rating	Recommendation
NSDC 21	Newark & Sherwood	Land at NSK, Northern Road	0	Good	Protect for mixed use with an element of employment use.
NSDC 22	Newark & Sherwood	Land west of the A1 on Stephenson Way	7.56	Good	Allocate for employment uses
NSDC 23	Newark & Sherwood	Land south of Newark (NAP 2A)	43.89	Good	Allocate for employment uses Retain strategic site designation with employment uses on this site
NSDC 24	Newark & Sherwood	Land around Fernwood (NAP 2C)	13.49	Very Good	Allocate for employment uses Retain strategic site allocation (Land around Fernwood – NAP 2C) for use class E office development ⁸⁴
NSDC 25	Newark & Sherwood	Land at Thoresby Colliery	3.24	Average	Designate for mixed-use with employment uses on this site. Retain allocation as a mixed-use strategic site including employment uses on this site
NSDC 26	Newark & Sherwood	Former Clipstone Colliery	10.8	Average / Poor	Designate for mixed-use with employment uses on this site. Retain allocation as a mixed-use site including 12 ha (gross) for employment with scope for a modest element of use class E office development.

7.35 Of the 56 sites assessed across the three Nottingham Outer HMA districts, 51 were considered suitable for employment and therefore recommended to be retained as such sites, comprising a total net developable area of **239.5 ha** for office, industrial and distribution use. This included all of the sites in Ashfield (14 sites totalling 87.93 ha net; all of the Mansfield sites (16 sites totalling 21.71 ha net) and 21 sites within Newark and Sherwood (129.86 ha net).

7.36 The vast majority of the sites were rated either ‘very good’, ‘good’ or ‘average’. Despite a few of sites appraised having some constraints either by policy, ownership or physically, they generally fulfil wider employment functions and justified being retained as a result of their locality to existing major road networks, transport connections and/or providing employment accommodation for niche or local businesses.

7.37 The tables above include recommendations for four sites which are considered to be suitable for mixed use sites with an element of employment space. These comprise:

- **NSDC20 Land North of the A17** (Newark and Sherwood);

⁸⁴ However, in reality, it is unlikely that the whole site will come forward for Use Class E office development and there is likely to be an element of mixed use development, suggested uses are set out in the site assessment. It is not the purpose of this study to determine the split of these uses.

- **NSDC21 Land at NSk, Northern Road** (Newark and Sherwood);
- **NSDC25 Land at Thoresby Colliery** (Newark and Sherwood);
- **NSDC26 Former Clipstone Colliery** (Newark and Sherwood).

7.38

In addition, there were two sites, **MDC9 Ransom Wood Business Park** (Mansfield) and **NSDC12 Crew Lane Industrial Area, Southwell** (Newark and Sherwood), where it was considered that the employment allocations should be retained but that there may also be some scope for mixed use. In relation to NSDC12 Crew Lane Industrial Area, it was considered that one of the existing employment allocations (So/E/3) is more likely to come forward later as part of any Local Plan Review and therefore the Council may wish to consider safeguarding this part of the site for employment uses, with potential future scope for an element of mixed-use development.

7.39

Similarly, there are several sites where we recommend that the employment boundaries should be revised, for the following reasons:

- The employment boundaries of the following sites within Ashfield should be amended to include the entire employment area: **ADC3 Lowmoor Business Park; ADC4 Oddicroft Lane; ADC5 Sherwood Business Park; ADC6 Park Lane Business Park; ADC7 The County Estate Nunn Brook Road/ Brookside Way; ADC10 Common Road, Industrial Estate, Export Drive; and ADC11 Fulwood Industrial Estate, Fulwood Road.**
- **NSDC2 Dixons Mastercare Site** (Newark and Sherwood) – The vacant land on this site should be allocated for employment uses, with the remainder of the developed land of the Mastercare site protected for employment uses.
- **NSDC12 Crew Lane Industrial Area, Southwell** (Newark and Sherwood) - The boundary could be amended to exclude the Southwell Court Care Home and Petrol Filling Station.

7.40

There are 18 sites which have now been fully built out and therefore do not have any net available land. However, it is considered that these sites should still be retained for employment uses and protected going forward given that the sites are occupied by employment uses. This comprises 5 sites within Ashfield; 10 in Mansfield; and 3 in Newark and Sherwood.

7.41

There are five sites which we consider are not suitable for employment use for the following reasons:

- **NSDC5 Bowbridge Road Policy Area** (Newark and Sherwood): There are a number of housing allocations within the site which would be incompatible with ongoing construction and extractive uses.
- **NSDC6 Flowserve Pump Division, Hawton Lane** (Newark and Sherwood): This site has a historical permission for residential development and is currently subject to an appeal for a decision to refuse permission for residential development.
- **NSDC8 Staythorpe Power Station** (Newark and Sherwood): This is a relatively remote site in a rural location. Any redevelopment would be

constrained by the undulating topography, flood risk, a railway line and overhead lines intersecting the site and potential contamination. The site is not allocated within the Local Plan and it is not recommended that it should be protected for employment uses.

- **NSDC9 Staunton Works, Alverton Road** (Newark and Sherwood): This is an isolated site in open countryside with poor strategic and local road access and which is constrained by flood risk. The site is not allocated within the Local Development Framework and it is not recommended that it be allocated.
- **NSDC17 Kirton Brick Works, Main Street** (Newark and Sherwood): The site is occupied by Kirton Brickworks and a clay pit. There are a number of constraints to the redevelopment of the site, including the remediation of any land contamination as part of wider quarry restoration scheme, the topography, the railway line, the environmental designations within and adjacent the site, nearby scheduled monuments, the ground water protection status of areas of the site and the hazardous installation designation. It is recommended that the designation as a permitted site for the extraction of minerals (brick clay) be retained. It is the responsibility of the County Council to make any changes any to this allocation.

7.42 In addition, the **NSDC15 Sherwood Energy Village** site in Newark & Sherwood District comprises of multiple smaller areas with different recommendations as follows: sites identified in the Allocations & Development Management DPD (2013) as having planning permission for employment (E PP) within the western site are allocated for employment uses; the eastern site identified as having planning permission for residential (Ho PP) should be retained for residential uses; and the recreational space on the central teardrop shaped sites should be protected. The small site to west of the central sites should not be allocated, given it has been developed for residential apartments.

Conclusion

7.43 In conclusion, the 8 Nottingham Core/Outer HMAs contain a diverse range of employment land across the authorities studied. The types of sites vary widely in size and occupants from the large and traditional industrial estates; to regeneration sites within the City Centre; and more rural locations which provide niche employment environments and accommodation.

7.44 133 sites were assessed across 8 local authorities. Of this total, 125 were recommended to be retained as employment sites, comprising a total net area (including a substantial element of mixed use) of 632.56 ha for office, industrial and distribution uses.

7.45 This included all the sites in Ashfield (14 sites totalling 87.93 ha net); all the Mansfield sites (16 sites totalling 21.71 ha net); 21 sites within Newark and Sherwood (129.86 ha net); all 7 sites within Gedling (21.95 ha, net); all 18 in Broxtowe (4.47 ha, net); 14 for Erewash (22.62 ha, net); 26 for Nottingham City (80.38 ha, net) (figure inclusive of the respective City Quarters and Development Sites); and all 9 of the strategic sites that were assessed in Rushcliffe (263.64 ha net).

- 7.46 The study has also identified 59 sites across the Nottinghamshire area that are fully developed.
- 7.47 As part of the assessment Lichfields also recommended that 12 of the sites review their employment boundaries on the ground of either excluding residential development within the site, to remove non-employment uses or include the complete employment area. This comprises 7 sites in Ashfield; 2 in Newark and Sherwood; and 3 in Nottingham City.
- 7.48 Lichfields has further recommended that 8 sites are not allocated /protected for employment use as they are not suitable or sustainable for that use. This comprises 5 in Newark and Sherwood; 1 in Nottingham City; and 2 in Erewash. These sites have been identified as either not fit for purpose; or the land use has shifted away from traditional industrial uses; or physical constraints affect potential for comprehensive redevelopment.

8.0 Stage 3) Future Employment Land Requirements

Introduction

- 8.1 This section considers the quantitative future economic growth needs in the Nottingham Core and Outer HMAs for the 20-year period 2018-2038. A number of different growth scenarios have been considered to test the likely need for employment land generated over the plan period in line with the Planning Practice Guidance recommendations. These scenarios consider the need for office and industrial (i.e. manufacturing and warehousing) floorspace. As requested by the client team, the final requirements are specified in floorspace (sqm) for office (incorporating R&D), and land (in hectares) for E-Class light industrial, B2 and B8 uses in order to align with the local authorities' employment land policies in their respective adopted/emerging Local Plans.
- 8.2 As well as considering the baseline forecast growth using Experian's most recent, Covid-19 adjusted September 2020 econometric projections, we have also compared this more pessimistic model run with the March 2020 iteration as well as a regeneration, or 'policy on' scenario, as well as taking into account past delivery of employment space and the potential labour supply generated by housing growth scenarios (using the Government's current Standard Methodology approach to calculating local housing need or LHN).
- 8.3 The forecast demand scenarios are based on a quantitative requirement and do not take into account qualitative factors that may influence the actual requirement. The aspirational 'policy on' growth scenario has, however, involved consultation with key economic development stakeholders and a review of developments and intervention projects that are likely to generate additional demand for employment space.

Methodology

- 8.4 The Government's Planning Practice Guidance advises on how to calculate future employment land requirement. The Guidance⁸⁵ sets out that strategic policy making authorities will need to "*develop an idea of future needs based on a range of data which is current and robust, such as:*
- *sectoral and employment forecasts and projections which take account of likely changes in skills needed (labour demand)*
 - *demographically derived assessments of current and future local labour supply (labour supply techniques)*
 - *analysis based on the past take-up of employment land and property and/or future property market requirements*
 - *consultation with relevant organisations, studies of business trends, an understanding of innovative and changing business models, particularly those which make use of online platforms to respond to consumer demand and monitoring of business, economic and employment statistics.*

⁸⁵ Planning Practice Guidance – Reference ID: 2a-027-20190220

- *Authorities will need to take account of longer-term economic cycles in assessing this data and consider and plan for the implications of alternative economic scenarios.”*

- 8.5 An aspirational ‘regeneration-led’ scenario has been included which takes into account additional demand that could be generated by key growth sectors, private sector developments and interventions.
- 8.6 The forecast employment land scenarios covering the 20-year period from 2018 to 2038 are:
- 1 Baseline employment forecasts (**labour demand**), using Experian’s Local Market Quarterly Forecasts for September 2020 (compared to the pre-Covid 19 March 2020 projection);
 - 2 Trending-forward **past jobs growth** experienced in the districts over the long term, from 1997-2018;
 - 3 **Regeneration-led** econometric model, which factors in the priority sectors targeted in the D2N2’s “*Spark in the UK’s Growth Engine Strategic Economic Plan - 2019-2030*”. This refers to 11 priority sectors important to the D2N2 economy for different reasons and which require different interventions in order to effectively contribute to productivity growth.
 - 4 Estimated growth in the **local labour supply** and the jobs and employment space that this could be expected to support. This is based upon the Government’s standard methodology for calculating housing need; and,
 - 5 Consideration of **past trends in completions of employment space** based on monitoring data collected by the Councils, and how these trends might change in the future.
- 8.7 All these approaches reflect different factors and careful consideration needs to be given as to how appropriate each is to circumstances in the 8 districts. In addition, to be robust, the economic growth potential and likely demand for employment space needs to be assessed under different future scenarios, to reflect lower or higher economic growth conditions arising in future.
- 8.8 The ultimate judgement regarding the level of employment need that the 8 districts should plan for is not, therefore, simply shaped by a consideration of quantitative analysis. A range of qualitative factors should be taken into account, that would typically consider the quality and demand for existing premises, the spatial distribution of supply and demand for premises, and insights from commercial property agents and local businesses.
- 8.9 It should be noted that the data provided by Council Officers relating to past take up is more detailed than was the case for the 2015 ELFS where it was offered a relatively low priority due to the inconsistency of much of the data, and hence it is considered that in this instance further weight can be attached to this approach than was previously the case.

Implications of Covid-19 on Future Growth and new Ways of Working

- 8.10 The ongoing COVID-19 pandemic will have significant impacts on the economy and businesses, with impacts varying dependent on the employment sector and the nature of the post-COVID-19 recovery. Coupled with the considerable economic uncertainty over Brexit, Lichfields considers that future growth projections could be subject to significant change. D2N2's recent work on economic recovery will be a helpful reference point for this work.
- 8.11 However, the most recent macro-economic forecasts were released by Experian at the end of September 2020. These include a base case 'delayed V-shaped' recovery scenario which provide a revised view on the areas of future economic growth across the country. The forecasts assume that the recovery will follow a delayed-V shape, with a substantial drop in output in Q2 2020 as economic activity was highly restricted due to lockdown measures to contain the virus.
- 8.12 Though viewed as a temporary shock, the forecasts imply a significant impact on almost all sectors of the economy. Although there are continued uncertainties regarding the economic recovery profile of the country, it is important that reliable and robust datasets are utilised to underpin the ELNS. The Experian forecasts remain a valuable input in respect of understanding future land needs by indicating the broad scale and direction of economic growth in different sectors.
- 8.13 A further implication of the ongoing COVID-19 pandemic is a shift in working patterns following the Government's advice to work from home if possible. The prevalence of this type of working had historically been rising, with the 2015 HCA Employment Guidance noting that 2014 ONS data indicated that almost 14% of the workforce worked from home at least some of the time, up from 11% in 1998. However, the COVID-19 pandemic has (at least temporarily), increased this to around 30% across the UK at the time of writing.
- 8.14 At the time of writing, clearly the third national lockdown has prevented a great many white collar staff from returning to the office, although it is unclear as to whether the current shift in working patterns will transform into a longer term change in people's willingness to commute to offices in far off towns and cities on a daily basis. At present the extant 2015 HCA Employment Density Guidance note provides employment densities associated with different types of property use, and it has been found to be robust as a rule of thumb guide to employment land densities underpinning numerous ELRs across the country. As a part of this, an element of home working and 'hot-desking' is already factored into the employment densities, although nowhere near current levels.

Growth Scenarios

A. Econometric Job Forecasting

Scenario 1) Post Covid-19 Experian Economic Forecasts (September 2020)

- 8.15 Experian econometric job forecasts were obtained by Lichfields to underpin this analysis. It should be emphasised that such forecasts tend to be most reliable at

regional and national scales and consequently less so at the local economy level. Nevertheless, they provide a valuable input in respect of understanding future land needs by indicating the broad scale and direction of economic growth in different sectors.

- 8.16 Experian’s model takes account of the existing economic structure of each Local Authority (broken down by economic sector) and the historical relationship between the regional performance of an industry and the performance observed at the Local Authority level. The forecasts of job growth by sector used here reflect recent trends and economic growth projections at national and regional level, and how economic sectors in the Nottingham Outer/Core HMAs have fared relative to the East Midlands’ growth in the past. They are not constrained by either labour supply or land availability.
- 8.17 Before presenting the job growth outcomes from the scenarios it is worth highlighting in broad terms, limitations in how these were generated:
- 1 They are predominantly trend-based estimates projecting historic growth patterns into the future.
 - 2 For the projections, the population data that underpinned the modelling comprises the ONS 2016 mid-year estimates [MYE] for 1997-2016. 2016-based sub-national population projections [SNPP] for England were also used by Experian.
 - 3 The forecasts do not take into account policy influences and unforeseen impacts of individual business decisions.
 - 4 There is not always a clear-cut relationship between employment change and employment land needs. Additional employment space may be required even if employment itself is falling; for example, if a manufacturing firm requires more space to enable greater automation and achieve job reductions through productivity gains.
- 8.18 Local area forecasts released by Experian in September 2020 provide an up-to-date view on the impact of Covid-19 for the 8 districts. Though viewed as a very significant, albeit hopefully temporary shock, the forecasts imply a significant impact on all sectors of the economy and all parts of the HMAs. As discussed in detail in Section 3.0, the forecasts are based on the assumption that the recovery will follow a delayed-V shape, with a substantial drop in output in Q2 2020 as economic activity was highly restricted due to lockdown measures to contain the virus.
- 8.19 Figure 8.1 and Figure 8.2 compare Experian’s pre- and post-Covid projections for both the Core and Outer Nottingham HMAs. They indicate that for both areas, the later projections not only factor in a very significant fall in the total number of workforce jobs in 2020, but that it won’t be until 2024 that we see a recovery to 2019 job levels (compared to 2023 across the UK as a whole). Just as worryingly, the projections indicate that there will be a permanent ‘scarring’ of the economy, with job growth following a similar trajectory under both sets of projections post 2024, but with a clear gap that is never fully closed.

Figure 8.1 Change in Total Workforce Jobs in Nottingham Core HMA (historic and projected) 2008 to 2038

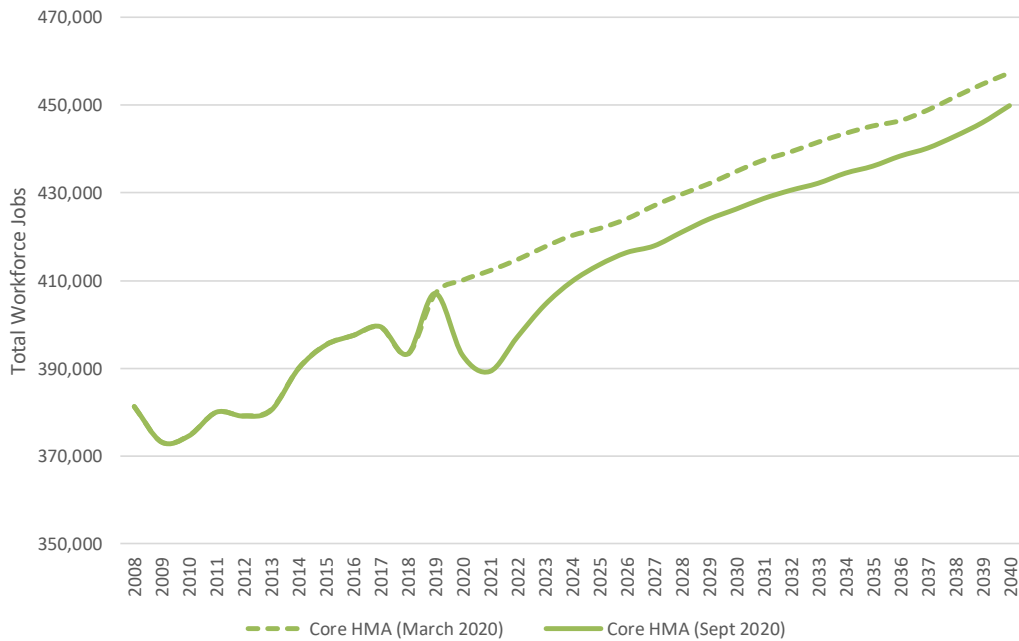

Source: Experian UK Macro Economic Forecasts September 2020 / March 2020

Figure 8.2 Change in Total Workforce Jobs in Nottingham Outer HMA (historic and projected) 2008 to 2038

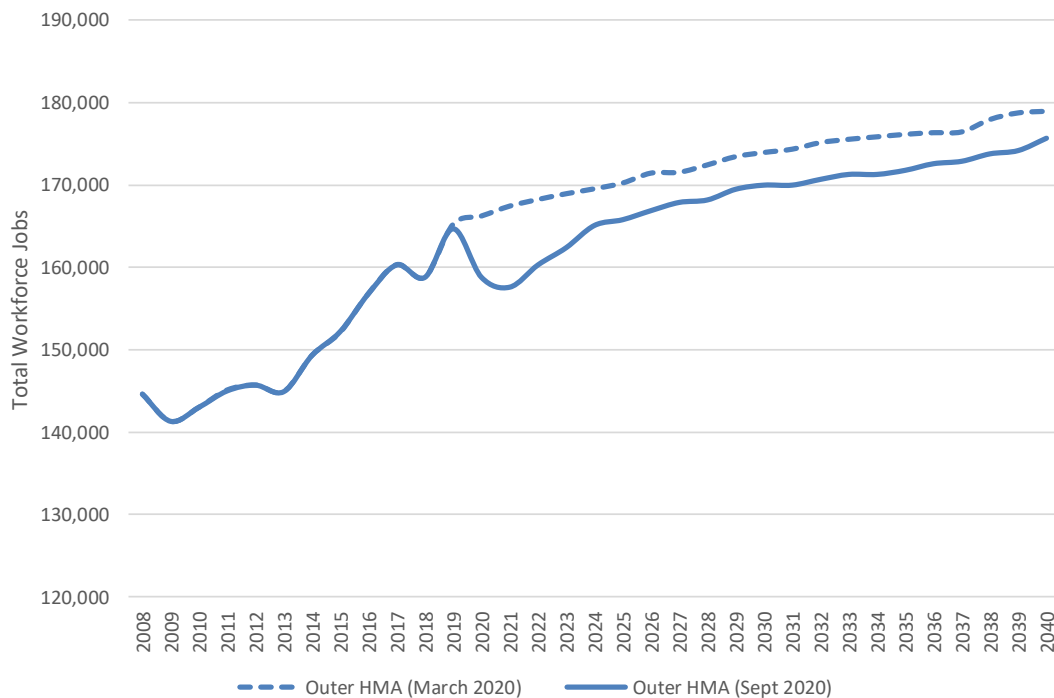

Source: Experian UK Macro Economic Forecasts September 2020 / March 2020

8.20

A detailed breakdown of the various projections is provided in Table 8.1 for the five Nottingham Core HMA districts and three Nottingham Outer HMA districts (and comparator areas). Over the longer term, the Table indicates that the September 2020 Experian baseline workforce employment projections reported a period of sustained employment growth since the depths of the last recession. Between 1997 and 2018, the Core HMA’s economy grew by 37,700 jobs, equal to

a Compound Annual Growth Rate [CAGR] of 0.481%. This is significantly lower than both the East Midlands and UK rates (0.77% and 0.95% respectively) and particularly the three Outer HMA districts which averaged an impressive 1.236% CAGR. Workforce jobs growth has been particularly strong in Nottingham City, Ashfield and Newark & Sherwood Districts, and was actually negative for Erewash and Gedling Boroughs.

8.21 In stark contrast however, over the Plan period of 2018-38 the September 2020 projections reverse the growth trends with the Core HMA districts forecast to experience growth rates of 0.596% overall (in excess of the East Midlands and UK rates), with the Outer HMA rate dropping by nearly two thirds to 0.452%. The growth is predominantly driven again by Nottingham City, which is projected to see a net increase of 33,000 jobs at a CAGR of 0.697%, followed by Rushcliffe (5,800 jobs at 0.588%), Newark & Sherwood (6,100 jobs at 0.516%) and Ashfield (5,500 jobs at 0.447%). It is apparent that for every district, the March 2020 Experian econometric projections forecast a much higher level of growth, equal to 9,100 additional jobs across the Core HMA and 4,100 jobs across the Outer HMA. The differential is more pronounced than for the UK as a whole, although the East Midlands regional fall is similarly concerning with a differential of almost 55,000 jobs.

Table 8.1 Workforce Jobs Growth for the Nottingham Core/Outer HMAs and comparator areas

	1997-2018		Experian September 2020 Projections 2018-2038		Experian March 2020 Projections 2018-2038	
	Net Jobs Growth	CAGR	Net Jobs Growth	CAGR	Net Jobs Growth	CAGR
Broxtowe Borough	7,700	0.985%	3,700	0.429%	4,700	0.539%
Erewash Borough	-2,900	-0.278%	4,800	0.476%	6,200	0.608%
Gedling Borough	-500	-0.066%	2,300	0.312%	2,700	0.364%
Nottingham City	26,800	0.617%	33,000	0.697%	38,000	0.796%
Rushcliffe Borough	6,600	0.730%	5,800	0.588%	7,100	0.710%
Nottingham Core HMA TOTAL	37,700	0.481%	49,600	0.596%	58,700	0.698%
Ashfield District	14,400	1.341%	5,500	0.447%	7,300	0.585%
Mansfield District	6,700	0.800%	3,400	0.377%	4,500	0.492%
Newark & Sherwood District	15,000	1.486%	6,100	0.516%	7,300	0.612%
Nottingham Outer HMA TOTAL	36,100	1.236%	15,000	0.452%	19,100	0.569%
<i>East Midlands</i>	<i>350,570</i>	<i>0.769%</i>	<i>242,620</i>	<i>0.490%</i>	<i>297,410</i>	<i>0.595%</i>
<i>UK</i>	<i>6,299,300</i>	<i>0.947%</i>	<i>4,022,070</i>	<i>0.544%</i>	<i>4,161,530</i>	<i>0.562%</i>

Source: Experian UK Macro Economic Forecasts September 2020 / March 2020

8.22 Table 8.2 summarises those sectors expected to experience the largest absolute increases or decreases in employment for the 8 Nottingham Core/Outer HMAs over the Plan period. Across the two HMAs, Experian project a growth equal to 64,600 net jobs between 2018 and 2038, driven in particular by Health (+13,800); Residential Care and Social Work (+13,400); Education (+8,300); and Professional Services (+7,400), with only the latter sector likely to see a significant amount of employment based on traditional 'employment' land. Job losses are almost entirely concentrated into one sector – manufacturing – which is projected to fall by 10,100 jobs over the next 20 years particularly in Nottingham City (-3,200) and Ashfield District (-3,600).

Table 8.2 Job Change across the Nottingham Core/Outer HMAs (2018 to 2038)

Sector	Broxtowe	Erewash	Gedling	Nottingham	Rushcliffe	Ashfield	Mansfield	Newark & Sherwood
Accom. & Food Services	100	500	200	2,200	100	100	400	1,500
Admin & Supportive Services	400	600	0	1,600	200	400	-200	200
Agriculture, Forestry & Fishing	0	0	0	0	0	0	0	-100
Air & Water Transport	0	0	0	0	0	0	0	0
Computing & Information Services	400	400	200	3,800	1,000	900	100	400
Construction	600	500	700	1,100	400	1,300	1,000	500
Education	500	800	300	4,500	600	500	700	400
Extraction & Mining	0	0	0	0	0	0	0	0
Finance	100	0	100	300	100	0	0	0
Fuel Refining	0	0	0	0	0	0	0	0
Health	400	1,000	500	7,900	300	2,900	400	400
Insurance & Pensions	0	0	0	100	0	0	0	0
Land Transport, Storage & Post	0	-300	400	1,800	100	0	-100	600
Manufacturing	100	-1,900	-600	-3,200	0	-3,600	-600	-300
Media Activities	0	0	0	0	0	0	0	100
Other Private Services	-300	-200	-200	1,200	-100	0	-200	900
Professional Services	200	100	200	4,900	1,400	0	300	300
Public Administration & Defence	0	0	-300	0	0	0	200	100
Real Estate	100	0	100	1,600	300	0	200	100
Recreation	0	100	0	500	400	-100	100	200
Residential Care & Social Work	900	2,200	1,000	4,100	800	2,000	1,100	1,300
Retail	-100	800	-400	1,100	400	600	0	-400
Telecoms	0	0	0	100	0	0	0	200
Utilities	100	100	0	-300	-100	-100	-100	-100
Wholesale	200	100	100	-300	-100	600	100	-200
TOTAL	3,700	4,800	2,300	33,000	5,800	5,500	3,400	6,100

Source: Experian (September 2020) / Lichfields' analysis
 Key: PURPLE = Office/Industrial sector GREEN = Part Office/Industrial sector

- 8.23 In translating these jobs into employment land requirements, the analysis includes an allowance for jobs in other non-employment sectors that typically utilise industrial or office space, such as some construction uses, vehicle repair, courier services, road transport and cargo handling and some public administration activities. This is because a certain proportion of these jobs will occupy premises falling within the office/industrial sectors.
- 8.24 Using Experian’s baseline forecasts (which are based to an extent on past trends and current representation across the industrial classifications relative to the national and regional averages), Table 8.2 indicates significant growth in

E(g)/B-class jobs for the Core HMA as a whole, equal to 11,991 between 2018 and 2038, although this level of growth is outstripped by more than 3-times this level of growth in the non-B uses (notably Health, Education and Residential Care and Social Work). As would be expected, there is strong growth in office-based activities of 13,873, although more than two thirds of this is located in Nottingham City with a further 20% in Rushcliffe Borough. There are some moderate gains in light industrial jobs growth (driven primarily by growth in the construction industry); declining manufacturing employment as previously; and surprisingly minor gains in distribution jobs (with Rushcliffe and Erewash even projected to see a net loss of job growth in sectors generally based in storage and warehousing).

8.25 Similar patterns are observed for the Outer HMA, albeit the scale of office employment growth is of a much lower magnitude than in Nottingham City. Again, net job growth relating to B8 distribution appears very low, at just 877 across the whole HMA over the next 20 years, whilst B2 general industrial employment is projected to fall particularly sharply in Ashfield District.

Table 8.3 Forecast Employment Change in the Nottingham Core/Outer HMA districts 2018-2038 – Experian September 2020 Baseline Total Workforce Jobs

	Office*	Light Industrial**	B2 General Industrial***	B8 Warehousing****	Total Office / Industrial / Distribution Jobs	Other Jobs	Jobs in All Sectors
Broxtowe	820	494	130	155	1,599	2,101	3,700
Erewash	586	81	-1,487	-165	-985	5,785	4,800
Gedling	432	502	-493	357	798	1,502	2,300
Nottingham	9,307	154	-2,522	639	7,579	25,421	33,000
Rushcliffe	2,728	294	-11	-10	3,000	2,800	5,800
CORE HMA	13,873	1,525	-4,383	976	11,991	37,609	49,600
Ashfield	808	198	-2,977	423	-1,547	7,047	5,500
<i>...of which located in Hucknall</i>	<i>132</i>	<i>32</i>	<i>-487</i>	<i>69</i>	<i>-253</i>	<i>1,153</i>	<i>900</i>
Mansfield	660	696	-656	6	706	2,694	3,400
Newark & Sherwood	1,023	309	-308	448	1,472	4,628	6,100
OUTER HMA	2,491	1,203	-3,941	877	631	14,369	15,000

Source: Experian September 2020 / Lichfields Analysis. Note figures are rounded

* includes a proportion of public sector employment and administration & support services

** includes some manufacturing, vehicle repair and some construction activities

*** includes manufacturing and some construction/utilities

****includes elements of transport & communications sectors

Note: Hucknall figure has been derived on a proportionate basis as c.16% of total BRES 2019 employment in Ashfield District is based in the four wards of Hucknall.

8.26 In order to translate the resultant job forecasts into estimates of potential employment space it is necessary to allocate the level of employment change forecast for office, industrial, and wholesale / distribution uses as follows (see Appendix 6 for a full definition of which Employment sector each SIC industry used in the Experian forecasts is classed within, by District):

- 1 The office floorspace requirement is related to job growth / decline in the financial and business service sectors⁸⁶;
- 2 The light industrial floorspace requirement is related to job growth / decline in some manufacturing sectors, specialised construction activities and some wholesale trades⁸⁷;
- 3 The general industrial floorspace requirement is related to job growth / decline in the majority of manufacturing sectors⁸⁸; and,
- 4 The wholesale / distribution floorspace requirement is related to job growth / decline in the industrial sectors of wholesale and land transport, storage and postal services.⁸⁹

8.27 Lichfields has then translated the resulting figures into employment land projections using standard employment densities that have been applied to the forecast job change figures (based upon the latest HCA⁹⁰ Guidance on employment densities). These translate FTEs into workforce jobs, and plot ratios by use class.

8.28 For the purposes of this ELNS it has been assumed that:

- 1 One general office workforce job requires 12.5 sqm of employment floorspace (Gross External Area [GEA]);
- 2 One light industrial job requires 54 sqm of employment floorspace [GEA];
- 3 One general industrial workforce job requires 36 sqm of employment floorspace [GEA];
- 4 One job per 64.5 sqm for general, small scale warehouses (assumed to account for 50% of all requirements) and 1 job per 79 sqm for large scale, lower density warehouses⁹¹ (assumed to account for the remaining 50% of all requirements).

8.29 This guidance takes account of recent trends in terms of the changing use of employment space, the main change being the more efficient utilisation of office space due to increased flexible working and hot-desking. This has resulted in a decrease in the amount of floorspace per office worker compared to previous guidance.

8.30 It is accepted that the current Covid-19 pandemic has dramatically altered working patterns, with the number of people working from home rising exponentially since the lockdown began in March 2020. UK-wide, 24% of people in employment are currently working exclusively from home instead of their usual place of work⁹². Many commentators are suggesting that there will

⁸⁶ i.e. Majority of BRES Sectors 58-74, Office administration and support, some activities of membership organisations and a proportion of Public Administration and Defence

⁸⁷ Some printing and recording media; manufacture of computer and electronic products; some manufacture of furniture and repair & installation of machinery & equipment; majority of Specialised Construction Activities, plus car repair.

⁸⁸ Remaining Manufacturing sectors, plus some construction and waste and remediation activities.

⁸⁹ Wholesaling less car repairs retail car sales, plus post/couriers and land transport

⁹⁰ HCA (November 2015): *Employment Densities Guide, 3rd Edition*

⁹¹ Strategic, or large-scale warehousing is generally defined as a distribution unit over and above 100,000 sq ft (9,290 sqm+).

⁹² Source:

<https://www.ons.gov.uk/peoplepopulationandcommunity/healthandsocialcare/conditionsanddiseases/bulletins/coronavirusthekeconomyandsocietyfasterindicators/1october2020>

be a permanent shift towards home working and the greater flexibility this affords people, with the need for office space in particular falling significantly.

- 8.31 Whilst in our view it is quite likely that there will be some long-term shift in working patterns as a result of the pandemic, at the time of writing (February 2021) it is still far too soon to say what the scale of that change on home working is likely to be. Until robust data is available later this year, we therefore propose to retain the aforementioned job densities, particularly as the HCA work already factors in an element of home working / hot desking into the calculations.
- 8.32 An adjustment has also been made to reflect the fact that a proportion of employment floorspace will always be vacant. Commercial and Industrial Property Research published by the VOA in 2005 indicates that for 2004/05, estimated vacancy rates for employment land totalled 8% for the East Midlands; 9% for England; 3% for Erewash; 7% for Broxtowe, Mansfield, Newark & Sherwood; 8% for Gedling and Rushcliffe; 9% for Ashfield and 10% for Nottingham City (7.4% across the two HMAs). Although these vacancy rates are 15 years old now, they still represent the most recent industrial vacancy rates produced by VOA which are consistent for all districts across the country.
- 8.33 Other sources are also now suggesting that a figure of around 7.5%⁹³ / 8% should be used to calculate the normal, or equilibrium vacancy rate.
- 8.34 Based on this data, it is reasonable to suggest that a return towards the lower end of the 8-10% 'ideal' vacancy rate typically used for ELRs across the 8 Nottinghamshire districts represents a robust benchmark for an appropriate level of available floorspace going forward, which reflects the longer-term equilibrium before the recession (both locally and nationally) and the historically low rate of vacancy experienced in parts of the Core HMA (Erewash in particular).
- 8.35 As per the previous 2015 ELNS, where a reduction in jobs is forecast (e.g. manufacturing), the associated negative floorspace was halved (in line with common methodological practice amongst ELRs undertaken elsewhere across the country), to reflect the fact that job decline at a particular company does not automatically translate into a comparable loss of floorspace, at least not in the short-medium term, due in part to companies being locked into leasing agreements etc.
- 8.36 The resultant floorspace estimates are provided in Table 8.4. They indicate an overall net gain of office/industrial floorspace in the Core HMA of 282,966 sqm between 2018 and 2038, and 100,833 sqm across the Outer HMA districts. This is driven by an increased demand for office, light industrial and B8 warehousing, with a continued fall in demand for industrial floorspace.

⁹³ Welsh Government (August 2015): Practice Guidance – Building an Economic Development Evidence Base to Support a Local Development Plan

Table 8.4 Forecast Net Floorspace Change (sqm) in the Core and Outer HMAs 2018-2038

v	Office	Light Industrial	B2 General Industrial	B8 Distribution	Total Office / Industrial / Distribution
Broxtowe	11,065	28,838	5,060	11,979	56,942
Erewash	7,913	4,735	-26,773	-5,906	-20,032
Gedling	5,835	29,292	-8,872	27,641	53,896
Nottingham	125,646	8,971	-45,390	49,547	138,774
Rushcliffe	36,822	17,126	-195	-367	53,386
CORE HMA	187,281	88,962	-76,170	82,894	282,966
Ashfield	10,914	11,561	-53,580	32,794	1,689
<i>...of which located in Hucknall</i>	1,785	1,891	-8,766	5,365	276
Mansfield	8,915	40,583	-11,804	429	38,124
Newark & Sherwood	13,806	18,010	-5,548	34,752	61,020
OUTER HMA	33,635	70,154	-70,932	67,975	100,833

Source: Experian September 2020 / Lichfields Analysis

Scenario 2) Pre-Covid Experian March 2020

- 8.37 As a sensitivity, this scenario mirrors the approach set out above, but instead of using Experian's September 2020 model run, it uses the equivalent from 6 months earlier. Crucially, this is pre-Pandemic and therefore factors in a more optimistic economic outlook, not just over the short term to 2024, but over the whole of the Plan period to 2038.
- 8.38 As can be seen from Table 8.5, the level of job growth across the Core HMAs is 58,700 over the 20 year plan period, 18% higher than the re-calibrated September 2020 model, whilst the net job growth across the three Outer HMA districts is 19,100 (27% higher than the Pandemic-adjusted forecast).

Table 8.5 Forecast Employment Change in the Nottingham Core/Outer HMA districts 2018-2038 – Experian March 2020
Baseline Total Workforce Jobs

	Office*	Light Industrial**	B2 General Industrial***	B8 Distribution****	Total Office / Industrial / Distribution Jobs	Other Jobs	Jobs in All Sectors
Broxtowe	835	593	239	232	1,898	2,802	4,700
Erewash	700	343	-1,222	-8	-187	6,387	6,200
Gedling	432	598	-479	434	985	1,715	2,700
Nottingham	9,250	421	-2,315	1,133	8,489	29,511	38,000
Rushcliffe	2,549	421	169	78	3,216	3,884	7,100
CORE HMA	13,766	2,376	-3,608	1,869	14,401	44,299	58,700
Ashfield	796	438	-2,583	635	-714	8,014	7,300
<i>...of which located in Hucknall</i>	<i>130</i>	<i>72</i>	<i>-423</i>	<i>104</i>	<i>-117</i>	<i>1,311</i>	<i>1,194</i>
Mansfield	618	795	-479	79	1,013	3,487	4,500
Newark & Sherwood	931	402	-290	606	1,650	5,650	7,300
OUTER HMA	2,345	1,635	-3,352	1,320	1,949	17,151	19,100

Source: Experian March 2020 / Lichfields Analysis. Note figures are rounded

* includes a proportion of public sector employment and administration & support services

** includes some manufacturing, vehicle repair and some construction activities

*** includes manufacturing and some construction/utilities

**** includes elements of transport & communications sectors

8.39

As before, the resultant floorspace estimates are provided in Table 8.6. They indicate a very significant overall net gain in employment floorspace across the Core HMA of around 413,100 sqm between 2018 and 2038 and over 169,000 sqm for the Outer HMA. The growth is driven by a strong past growth in B8 logistics jobs which is significantly higher than the September 2020 projection. This may be seen as something of an anomaly, given that the Pandemic has seen a very strong growth in internet shopping and the need for last mile logistics in particular.

Table 8.6 Forecast Net Floorspace Change (sqm) in the Core and Outer HMAs 2018-2038

	Office	Light Industrial	B2 General Industrial	B8 Distribution	Total Office / Industrial / Distribution
Broxtowe	11,268	34,605	9,274	17,969	73,116
Erewash	9,450	19,985	-22,004	-274	7,157
Gedling	5,835	34,887	-8,631	33,630	65,721
Nottingham	124,873	24,555	-41,663	87,797	195,562
Rushcliffe	34,410	24,577	6,554	6,009	71,551
CORE HMA	185,836	138,609	-56,470	145,131	413,107
Ashfield	10,741	25,535	-46,486	49,192	38,981
<i>...of which located in Hucknall</i>	1,757	4,178	-7,605	8,048	6,377
Mansfield	8,343	46,381	-8,624	6,128	52,228
Newark & Sherwood	12,573	23,463	-5,228	46,994	77,802
OUTER HMA	31,657	95,379	-60,338	102,314	169,011

Source: Experian March 2020 / Lichfields Analysis

Sensitivity Test: Past Trends Job Growth

- 8.40 This sensitivity test looks at past trends in jobs growth experienced in the 8 districts over the long term (1997-2018) and trends the resultant Compound Annual Growth Rate [CAGR] over the Plan period from 2018-2038.
- 8.41 As set out above, over the long term, the Outer HMA's economy has experienced particularly strong growth levels over the past 20 years or so, with the expected blip in the immediate aftermath of the recession in 2009/10-2010/11. Over that period (1997-2018), the number of jobs in the Outer HMA districts increased by 1.236% per annum (CAGR), almost three times the annual growth rate of the 5 districts that comprise the Core HMA (0.481%), with Erewash and Gedling Boroughs experiencing negative growth over this time period.
- 8.42 Applying these CAGR rates annually from 2018 to the total jobs growth for each district, equates to a net job growth of 42,130 to 2038 for the 5 districts in the Core HMA, and 44,852 jobs across the three Outer HMA districts. Assuming the same sectoral representation for each industry in 2038 as the September 2020 Experian baseline, constrained to the aforementioned overall net job growth figures, would result in a strong office/industrial job growth of 9,672 to 2038 in the Core HMA and 11,563 in the Outer HMA as summarised in Table 8.7.

Table 8.7 Forecast workforce jobs change in the Nottingham Core/Outer HMA districts 2018-2038 – Past Trends

	CAGR 1997-2018	Office*	Light Industrial**	B2 General Industrial***	B8 Distribution****	Total Office / Industrial / Distribution Jobs	Other Jobs	Jobs in All Sectors
Broxtowe	+0.985%	1,701	854	762	667	3,984	4,979	8,963
Erewash	-0.278%	-229	-636	-2,391	-741	-3,997	1,388	-2,609
Gedling	-0.066%	109	228	-761	125	-299	-171	-470
Nottingham	+0.617%	8,446	31	-2,611	467	6,332	2,2617	28,950
Rushcliffe	+0.730%	3,164	363	43	82	3,652	3,644	7,296
CORE HMA	+0.481%	13,191	840	-4,958	600	9,672	32,457	42,130
Ashfield	+1.341%	2,137	1,070	-1,690	1,679	3,196	14,820	18,016
<i>...of which located in Hucknall</i>	<i>+1.341%</i>	<i>350</i>	<i>175</i>	<i>-276</i>	<i>275</i>	<i>523</i>	<i>2,425</i>	<i>2,947</i>
Mansfield	+0.800%	1,156	982	-304	247	2,081	5,431	7,512
Newark & Sherwood	+1.486%	2,724	959	1,015	1,589	6,286	13,038	19,324
OUTER HMA	+1.236%	6,017	3,011	-979	3,515	11,563	33,289	44,852

Source: Experian September 2020 / Lichfields Analysis

- 8.43 The resultant floorspace estimates are provided in Table 8.8. They indicate a very significant overall net gain in employment floorspace of around 539,000 sqm between 2018 and 2038 in the Outer HMA and c.252,000 sqm in the Core HMA. Overall, the employment floorspace need is driven by a strong past growth in Office jobs and to a lesser extent, light industrial and B8 warehousing in the districts in recent years (with the restructuring of the general industrial manufacturing sector continuing apace, particularly in Erewash and Nottingham City).
- 8.44 **It is considered that only very limited weight can be attached to this modelling exercise as the past rates of job growth, particularly for the Outer HMA, are of a very different magnitude to the much weaker Experian projections for 2020, which factor in the likely impacts of Brexit and Covid-19.**

Table 8.8 Past Trends workforce job growth net employment floorspace requirements 2018-2038

	Office	Light Industrial	B2 General Industrial	B8 Distribution	Total Office / Industrial / Distribution
Broxtowe	22,958	49,816	29,645	51,669	154,088
Erewash	-1,434	-17,172	-43,034	-26,582	-88,222
Gedling	1,475	13,288	-13,695	9,674	10,742
Nottingham	114,023	1,789	-47,004	36,176	104,984
Rushcliffe	42,710	21,172	1,680	6,336	71,898
CORE HMA	179,732	68,893	-72,408	77,273	253,490
Ashfield	28,850	62,429	-30,420	130,105	190,964
<i>...of which located in Hucknall</i>	4,720	10,213	-4,977	21,285	31,242
Mansfield	15,603	57,260	-5,465	19,114	86,511
Newark & Sherwood	36,770	55,904	39,448	123,151	255,273
OUTER HMA	81,223	175,593	3,563	272,370	532,748

Source: Experian September 2020 / Lichfields Analysis

Scenario 3) Regeneration

- 8.45 An alternative job-based estimate of future needs was previously compiled which was termed the D2N2 LEP 'Policy-On', scenario. This was based upon a review of the D2N2's previous Strategic Economic Plan [SEP] which set out one single Growth Strategy target – to support the creation of an additional 55,000 private sector employee jobs in D2N2 by 2023. The SEP set out a number of priority actions, with job outputs aligned to various projects. This suggested that over 32,000 of the 55,000 private sector jobs target could be based in the Nottingham Core and Outer HMA districts. The previous 2015 ELFS mapped this job target across to 'best fit' with the standard industrial sectors which form the basis of the Experian forecasts. In addition, an allowance was made for the likely job growth associated with the proposed HS2 station at Toton.
- 8.46 The latest version of the D2N2 SEP, '*D2N2 – the Spark in the UK's Growth Engine Strategic Economic Plan - 2019-2030*' takes a different tack and moves away from job creation as a specific target, and moves towards tackling the productivity gap in order to remain a competitive business location and to deliver long term prosperity.
- 8.47 To do this, the D2N2 LEP's SEP identifies 11 priority sectors that are important to the D2N2 economy for different reasons and will need different interventions in order to effectively contribute to productivity growth. "*Our priority sectors are split into 2 categories, our Science and Innovation Core Sectors and our Opportunity Sectors. These sectors have been identified according to their degree of specialisation, tradeable 'clustering', concentration of employment or prospects for growth as described below.*" [page 35]

Figure 8.3 Focus of Support: D2N2 Core and Opportunity Business Sectors by Business Types and Enabling Competencies

	Sector Analysis	Specialism ¹	Cluster ²	Jobs ³	Growth ⁴
Core	Transport Equip. Man.	√	√		√
	Food & Drink Man.	√	√		√
	Life Sciences	√	√		√
Opportunity	Creative & Digital		√		√
	Visitor Economy		√		√
	Logistics & ECommerce	√	√		√
	Construction		√	√	√
	Extractive Industries	√	√	√	√
	Retail			√	√
	Health/Social Care			√	√
	Prof./Business Services		√		√

	Priority Science and Innovation Sectors			Priority Opportunity Sectors						High Employment Sectors	
Priority Sectors	Transport Equipment Manufacturing	Food & Drink Manufacturing	Life Sciences	Creative & Digital	Visitor Economy	Logistics & Ecommerce	Construction	Mineral Products	Professional & Business Services	Retail	Health & Social Care
Characteristics	Large, highly specialised, growing & productive. Knowledge assets. Major OEMs	Specialised and forecast to intensify. Employment growth. Average productivity. Knowledge assets	Small but specialised & productive. Growth prospects. Knowledge assets	Rapid growth sector. Not specialised in D2N2. Digital highly productive.	Large employer. Low productivity but potential for growth. Not specialised in D2N2. Cultural assets	Large, specialised, growing. Average productivity but more productive in D2N2 than UK	Large, growing. Future growth. Average productivity & specialisation. Knowledge assets.	Locally specialised. Local supply chains. Low employment. Strategic resource for growth.	Small, but productive and growing. Data analytics assets.	High employment, low productivity. More productive in D2N2 than UK	High employment, low productivity. Large growth predicted
Key Actions	Supply chain support	Provision of high standard premises	Provision of high standard premises	Provision of high standard premises	Raise value of visitor spend	Availability of sites	Technical skills	Transport infrastructure	Provision of high standard premises	Digital skills & connectivity	Digital skills & connectivity
Cross Sector Priorities	Skills for digital manufacturing	Export support	Growth investment	Growth investment	Digital skills & connectivity	Technical skills	Digitalisation & MMC	Technical skills	Inward investment	Innovation adoption	Innovation adoption
	Link clusters to world class research	Link clusters to world class research	Link clusters to world class research	Leadership & management	International marketing & connectivity, HS2	Accommodation	HS2 construction	HS2 construction	HS2 connectivity	Town and City Centres	
Science and Innovation: Enabling Competencies	Advanced Manufacturing & Engineering Digital Technologies & Data Energy & Low-Carbon Technologies Systems Integration			To exploit our competitive advantages, we will work with business, universities and partners to			<ol style="list-style-type: none"> 1. increase productivity through exploitation & adoption of new technologies & processes 2. Support the development and commercialisation of innovative products, goods & services 3. increase industry & research base links to accelerate commercialisation & innovation. 				
Business Support Focus	Re-purpose D2N2 Growth Hub and support programmes to focus on productivity improvement across sectors through access to investment, digitalisation, innovation, leadership and management, high growth, exporting, innovation and skills support.						'Middle Band' Businesses with productivity around average High-Growth & Potential Scale-ups, potential scale-ups, and businesses with ambition to grow Major Manufacturers and other 'Anchor' Businesses Rolls-Royce, Toyota, Bombardier, Boots, Experian etc...				

Source: D2N2 (2019): Strategic Economic Plan: The Spark in the UK's Growth Engine, Vision 2030

8.48

Following discussions with Officers, the relevant Experian sectors were matched in line with the 3 core sectors and 8 Opportunity Sectors as follows:

Table 8.9 D2N2 Target Growth Sectors and SIC2 sectors

	D2N2 SEP Target Growth Sectors	Approximate Comparable Standard Industrial Classifications (Comparable Growth Rates 2018-2038 in Brackets)
CORE SECTORS	Transport Equipment Manufacturing	<ul style="list-style-type: none"> • Transport Equipment Manufacturing (East Midlands -4.9% / UK -3.6%) • Machinery & Equipment Manufacturing (East Midlands -16.4% / UK -20.4%)
	Food and Drink Manufacturing	<ul style="list-style-type: none"> • Food, Drink & Tobacco Manufacturing (East Midlands -3.4% / UK -8.6%)
	Life Sciences	<ul style="list-style-type: none"> • Manufacture of Pharmaceutical Products (East Midlands +9.2% / UK +27.8%)
OPPORTUNITY SECTORS	Creative & Digital	<ul style="list-style-type: none"> • Computing and Electronic Products Manufacture (East Midlands -16.2% / UK -17.8%) • Computing and Information Services (East Midlands +38.9 / UK +17.2%) • Media Activities (East Midlands +1.7% / UK +13.0%) • Printing and Recording Media Manufacture (East Midlands -45.0% / UK -43.1%)

		<ul style="list-style-type: none"> Telecoms (East Midlands -2.2% / UK -2.1%)
	Visitor Economy	<ul style="list-style-type: none"> Accommodation and Food Services (East Midlands +13.6% / UK +16.6%) Recreation (East Midlands +11.2% / UK +12.5%)
	Logistics & eCommerce	<ul style="list-style-type: none"> Land Transport, Storage & Post (East Midlands +13.4% / UK +16.0%) Wholesale (East Midlands +2.0% / UK +0.9%)
	Construction	<ul style="list-style-type: none"> Civil Engineering (East Midlands +6.1% / UK 4.2%) Construction of Buildings (East Midlands +7.2% / UK +4.9%) Specialised Construction Activities (East Midlands +16.3% / UK +8.6%)
	Mineral Products (Extractive Industries)	<ul style="list-style-type: none"> Extraction and Mining (East Midlands -12.5% / UK -15.5%)
	Professional and Business Services	<ul style="list-style-type: none"> Administrative and Support Services (East Midlands +10.1% / UK +14.5%) Finance (East Midlands +4.7% / UK +11.8%) Insurance & Pensions (East Midlands +4.7% / UK +6.1%) Professional Services (East Midlands +21.9% / UK +22.7%) Real Estate (East Midlands +24.3% / UK +28.2%)
	Retail	<ul style="list-style-type: none"> Retail (East Midlands +4.2% / UK -0.3%)
	Health and Social Care	<ul style="list-style-type: none"> Health (East Midlands +27.7% / UK +28.2%) Residential Care and Social Work (East Midlands +39.6% / UK +36.8%)

Source: Lichfields Analysis / CCDC EDO /WMCA SEP

8.49 The Table shows the percentage growth between 2018-38 for the East Midlands and the UK as a whole. We have applied the highest growth rate to the 3 Core Growth Sectors, and whichever is the higher of the district growth rate and the lowest of either the EM or UK figure for the Opportunity Sectors.

8.50 The adjustments to the Experian forecasts outlined above result in an overall increase of 58,608 jobs to 2038 (9,008 higher than the baseline) for the 5 Core HMA districts, and an increase of 20,581 jobs (5,581 higher than the September 2020 baseline) for the three Outer HMA districts. There is also an increase in E/B-Class jobs in the Core HMA districts of 16,539 (5452 higher than previously) and 3,200 E/B Class jobs in the Outer HMA (2,569 higher than in the baseline). Table 8.10 summarises the forecast job growth in the Regeneration Scenario.

Table 8.10 Regeneration workforce job change in the Nottingham Core and Outer HMAs 2018-38

	Office*	Light Industrial**	B2 General Industrial***	B8 Distribution****	Total Office / Industrial / Distribution Jobs	Other Jobs	Jobs in All Sectors
Broxtowe	1,313	494	281	443	2,531	2,663	5,194
Erewash	1,138	86	-1,205	285	303	5,928	6,231
Gedling	639	532	-376	357	1,152	2,464	3,616
Nottingham	9,559	324	-1,602	940	9,220	27,231	36,451
Rushcliffe	2,734	294	-2	127	3,153	3,963	7,116
CORE HMA	15,383	1,730	-2,904	2,152	16,359	42,249	58,608
Ashfield	1,553	206	-2,512	686	-66	7,540	7,473
<i>...of which located in Hucknall</i>	254	34	-411	112	-11	1,233	1,233
Mansfield	841	696	-656	156	1,036	4,039	5,075
Newark & Sherwood	1,497	309	-165	589	2,230	5,803	8,033
OUTER HMA	3,891	1,211	-3,333	1,431	3,200	17,382	20,581

Source: Experian / Lichfields' Analysis

* includes a proportion of public sector employment and administration & support services

** includes some manufacturing, vehicle repair and some construction activities

*** includes manufacturing and some construction/utilities

****includes elements of transport & communications sectors

8.51

These employment forecasts were then converted to floorspace requirements in the same manner as the Experian baseline forecast. The resulting forecasts are more optimistic in terms of office and light industrial job growth and particularly warehousing growth (and less pessimistic for general industrial declines). These are set out in Table 8.11.

Table 8.11 Regeneration jobs based (net) employment space requirements in the Core and Outer HMAs 2018-2038

	Office	Light Industrial	B2 General Industrial	B8 Distribution	Total Office / Industrial / Distribution
Broxtowe	17,720	28,838	10,926	34,326	91,809
Erewash	15,358	4,998	-21,699	22,110	20,766
Gedling	8,630	31,001	-6,763	27,641	60,510
Nottingham	129,040	18,879	-28,836	72,837	191,920
Rushcliffe	36,910	17,126	-32	9,849	63,853
CORE HMA	207,658	100,842	-46,404	166,763	428,858
Ashfield	20,972	12,034	-45,218	53,163	40,952
<i>...of which located in Hucknall</i>	3,431	1,969	-7,398	8,698	6,700
Mansfield	11,348	40,583	-11,804	12,068	52,195
Newark & Sherwood	20,209	18,010	-2,966	45,647	80,900
OUTER HMA	52,529	70,627	-59,988	110,878	174,047

Source: Lichfields' Analysis

B. Future Labour Supply

- 8.52 It is also important to take into account how many jobs (and hence how much employment space), would be necessary to broadly equate to the future objectively assessed need for housing across the eight local planning authorities. In contrast to the other approaches, this approach focuses on the future supply of labour rather than the demand for labour. This scenario indicates the amount of new jobs needed to match the future working-age population, and how much employment space would be needed to accommodate these jobs.
- 8.53 The number of economically active people (and therefore jobs) the 2014-based household projections is expected to generate can be calculated by applying projected economic activity rates (by sex and age) to the equivalent sub-national population projections. These population projections underpin the household projections which dictate the baseline number of homes which need to be built in an authority area. This gives a 'baseline' number of jobs which will be supported by the 'baseline' number of homes under the standard method.
- 8.54 Additional homes are provided as part of the affordability uplift in the standard method. The impact on these additional homes on the number of jobs depends on whether these additional homes will:
- 1 Result in more people moving into the area (than the SNPP projects), in which case the additional homes will be expected to support additional jobs; or,
 - 2 Induce additional household formation amongst people already living the authority area, in which case the additional homes will not support additional jobs (on top of the baseline projection) because the overall number of economically active people in the authority area is the same as the baseline, they just live in more households.
- 8.55 In reality, it cannot be accurately determined to what degree the additional homes (from the affordability uplift) will generate additional people (and therefore jobs) above the baseline SNPP. If every authority in the country met its standard method figure then – theoretically – we would expect there to be no 'additional' movement between authorities (over and above that already accounted for in the SNPP) because enough homes would be provided in every authority area to meet existing residents' needs. This means the impact of the uplift in one area will also be affected by the activities of neighbouring areas; if those areas provide sufficient homes to meet their needs (in line with the standard method) there is less likelihood that additional homes in the authority in question will generate in-migration (and more likely that additional homes will be filled by existing residents). If neighbouring areas fail to meet their housing needs, it becomes more likely that additional homes in the authority in question will be taken up by in-migrants searching for housing beyond the area they currently live in (thus generating population and job growth).
- 8.56 On this basis we have calculated an upper and lower range:
- **A 'baseline' number of jobs which is expected to be support by the SNPP.** This is the minimum number of jobs expected to be supported by the standard method; and

- **An ‘uplift’ number of jobs which calculates the number of jobs we expect to be supported under the standard method with the affordability uplift.** This assumes the additional homes will ‘inflate’ the population of the authority area on a proportional basis, reflecting the age/sex profile of the SNPP at the end of the plan period. This may over-estimate the number of jobs supported because (for the reasons set out above) these additional homes may be filled by existing residents; however, it could also under-estimate the number of jobs that the uplift could support because the profile of people who migrate is generally younger (and therefore more economically active) compared with the population as a whole. This sensitivity test should therefore be taken as a theoretical upper end of any range taken forward by the eight Councils.

Scenario 5) Baseline Labour Supply (2014-based SNPP) and Scenario 6) Standard Methodology for Calculating LHN

8.57

Lichfields has undertaken high-level modelling to identify an indicative labour supply scenario for the 8 Nottingham HMA districts in this study, incorporating the following assumptions:

- 1 **Population change** over the Local Plan period 2018-2038, drawing on the ONS’s 2014-based Sub-National Population Projections [SNPP] to align with the Government’s standard methodology.
- 2 **Economic activity rates for 2019** and anticipated future changes in economic activity rates for males and females over the age of 16 years old. These were estimated by using the ONS’s Annual Population Survey data for each district and the 2018/2019 Mid-Year Population estimates [MYE], then projected forward using the growth rates published by the OBR in July 2018⁹⁴.
- 3 An **unemployment rate** for 2018 and 2019 taken from the ONS Annual Population Survey [APS] Model-based Unemployment rate for those years. As the unemployment rates are historically low for each of the 8 districts, we have increased the current rates to the medium-term average (based on the past 6-year trend 2014-2019). Whilst it is highly likely that the unemployment rate will increase substantially over the next few years due to the economic crisis precipitated by the pandemic and ongoing Brexit uncertainty, clearly, we are planning for the long term, which takes into account a number of economic cycles.
- 4 A **Labour Force Ratio** based on the APS (the number of economically active residents), unemployment rates and the September 2020 Experian employment projections (used for Scenario 1). If the Labour Force (LF) Ratio is over 1.0, this means that there were more residents in employment living in the district than there were jobs (see for example, Gedling and Mansfield), whereas if the LF is below 1.0, then there were more jobs than workers living in an area, resulting in net inward commuting patterns (Nottingham City being the most obvious example). The LF ratio was then held constant over the plan period 2018-2038.

⁹⁴ OBR [Fiscal Sustainability Report – Supplementary data series](#)

- 8.58 The ONS's 2014-based population projections (which underpin the Government's standard methodology for calculating local housing need) indicates an additional 90,159 persons living in the Core HMA between 2018 and 2038, of which 78,527 additional persons will be over the age of 16 years old (children between 0 to 15 years old are expected to increase by 11,632 across the Plan period). However, the bulk of this growth will be in the over 65 age cohorts, ensuring that this does not translate into a commensurate increase in jobs growth. Applying the adjusted OBR economic activity rates for the 5 Core HMA districts reduces this figure down to 39,877 over the next 20 years. Factoring in unemployment allowances and labour force ratios (which increases the jobs figure for Nottingham City, but reduces it elsewhere due to net out commuting levels), Table 8.12 indicates that this equates to a net job growth of 40,491 over the 20-year plan period.
- 8.59 As for three Outer HMA districts, the 2014-SNPP suggests that there will be an increase of 34,405 persons living in the area between 2018 and 2038, of which 14,805 will be living in Ashfield. Again, the bulk of this growth will be in the over 65 age group, hence following the application of the OBR economic activity growth rates results in a net increase of just 13,698 economically active residents in the three districts (the majority of which are projected to live in Ashfield). As can be seen in Table 8.12, applying the unemployment rates and LF ratios equates to a net job growth of 11,505 over the 20-year plan period, of which 7,501 (or 65%) are projected to be located in Ashfield District.

Table 8.12 Projected population and labour force change associated with 2014-based SNPP, 2018-38

	Total Population Growth	Over 16 Population Growth	Economically Active Population Growth	Net Jobs Growth 2018-38
Broxtowe	12,449	10,033	3,596	+2,468
Erewash	12,196	10,895	2,160	+1,607
Gedling	14,224	12,126	7,695	+4,293
Nottingham	35,457	31,433	21,550	+28,648
Rushcliffe	15,833	14,040	4,876	+3,475
Core HMA TOTAL	90,159	78,527	39,877	+40,491
Ashfield	14,805	13,198	8,007	+7,501
<i>...of which Hucknall*</i>	-	-	-	+2,091
Mansfield	6,626	6,661	2,751	+1,770
Newark & Sherwood	12,974	11,517	2,940	+2,234
Outer HMA TOTAL	34,405	31,376	13,698	+11,505

Source: Lichfields analysis, based on 2014 SNPP, APS data and OBR economic activity projections

*Note: Hucknall figure has been derived on a proportionate basis as c.28% of total 2019 Mid-Year Population Estimate (Source: ONS 2019 Population estimates - small area based by single year of age - England and Wales) in Ashfield District is based in the four wards of Hucknall.

- 8.60 As set out above, Scenario 6 has uplifted the number of jobs that we would expect to be supported under the standard method with the affordability uplift. This assumes the additional homes will 'inflate' the population of the authority area on a proportional basis, reflecting the age/sex profile of the SNPP at the end of the plan period. This rate of increase is then applied to the population growth differential between the two projections for 2038). We have applied this level of increase equally to each age/gender cohort and have assumed that the increase will apply evenly across the Plan period, with all other inputs held constant. The results are set out in Table 8.13.

- 8.61 It indicates that across the Core HMA, with an overall LHN of 3,373 dwellings per annum [dpa] and affordability uplifts ranging from 14% (Erewash and Gedling) to as much as 43% (Nottingham City), the estimated net job growth rises to 59,095 in total 2018-38, of which the majority relates to growth in Nottingham City (42,169, or 71%). As for the Outer HMA, with a much lower LHN of 1,250 dpa and an affordability ratio uplift ranging from 11% (Ashfield) to 26% (Newark and Sherwood), the estimated net jobs growth is 15,272 with Ashfield again taking the lion's share (8,670).

Table 8.13 Projected population and labour force change associated with the Government's Standard Method for Calculating Housing Need, 2018-38

	Housing Need based on SM	Affordability Ratio Uplift	Estimated Net Jobs Growth 2018-38
Broxtowe	368 dpa	17%	+3,284
Erewash	392 dpa	14%	+2,294
Gedling	458 dpa	14%	+5,103
Nottingham	1,551 dpa	43%	+42,169
Rushcliffe	604 dpa	34%	+6,245
Core HMA TOTAL	3,373 dpa	-	+59,095
Ashfield	481 dpa	11%	+8,670
<i>...of which Hucknall*</i>	-	-	+2,417
Mansfield	275 dpa	14%	+2,355
Newark & Sherwood	494 dpa	26%	+4,247
Outer HMA TOTAL	1,250 dpa	-	+15,272

Source: Lichfields analysis, based on 2014 SNPP, APS data, MHLCG data and OBR economic activity projections

*Note: Hucknall figure has been derived on a proportionate basis as c.28% of total 2019 Mid-Year Population Estimate (Source: ONS 2019 Population estimates - small area based by single year of age - England and Wales) in Ashfield District is based in the four wards of Hucknall.

- 8.62 To calculate the employment floorspace implications of these projections, the same assumptions concerning vacancy rates and employment densities as per the Experian September baseline econometric demand-side forecasting work were applied to these job projections. The same distribution of employment by Use Class as the Experian baseline scenario was also applied.
- 8.63 The resultant projections and their job growth forecasts are presented in Table 8.14. This indicates that the net office floorspace growth for the Core HMA equals 161,247 sqm over the plan period 2018-38, rising to 215,094 sqm with the AR uplift. For the industrial/distribution floorspace, the 2014-based SNPP labour supply scenario equates to just 40,461 sqm net, rising very substantially to 160,099 sqm based on the AR uplift (predominantly due to the very large Nottingham City uplift). For the Outer HMA, the net office floorspace need under the 2014 SNPP equates to 27,138 sqm, rising to 33,260 sqm with the SM uplift. For the Industrial / distribution floorspace, this ranges from 37,923 sqm to 81,280 sqm depending on the scale of uplift applied.

Table 8.14 Net Office / Industrial floorspace required from labour supply growth scenarios 2018-2038 (sqm)

	Scenario	Office	Light Industrial	General Industrial	Distribution	TOTAL
Broxtowe	5) 2014 SNPP	8,281	23,927	-321	2,689	34,576
	6) SM LHN	10,125	27,180	3,117	8,842	49,264
Erewash	5) 2014 SNPP	3,168	-6,154	-33,781	-14,817	-51,583
	6) SM LHN	4,189	-4,358	-32,273	-12,900	-45,342
Gedling	5) 2014 SNPP	8,973	40,808	-5,402	40,570	84,948
	6) SM LHN	10,248	45,488	-3,992	45,824	97,568
Nottingham	5) 2014 SNPP	113,157	1,254	-47,124	35,180	102,467
	6) SM LHN	151,958	25,228	-41,735	79,816	215,266
Rushcliffe	5) 2014 SNPP	27,668	10,837	-1,707	-5,498	31,299
	6) SM LHN	38,574	18,330	204	1,328	58,436
CORE HMA TOTAL	5) 2014 SNPP	161,247	70,672	-88,335	58,124	201,707
	6) SM LHN	215,094	111,868	-74,679	122,910	375,192
Ashfield	5) 2014 SNPP	13,781	19,693	-49,878	48,352	31,948
	6) SM LHN	15,456	24,444	-47,715	57,440	49,626
...of which Hucknall	5) 2014 SNPP	3,493	6,734	-6,561	14,629	18,294
	6) SM LHN	3,960	8,058	-5,958	17,162	23,223
Mansfield	5) 2014 SNPP	6,264	33,972	-14,317	-3,230	22,690
	6) SM LHN	7,216	36,345	-13,415	-2,000	28,146
Newark & Sherwood	5) 2014 SNPP	7,093	6,931	-12,509	8,909	10,424
	6) SM LHN	10,588	12,700	-8,884	22,365	36,769
Outer HMA TOTAL	5) 2014 SNPP	27,138	60,596	-76,704	54,031	65,062
	6) SM LHN	33,260	73,489	-70,014	77,805	114,541

Source: Lichfields analysis

- 8.64 These labour supply-based estimates provide a useful benchmark for comparison with labour demand approaches. This projection produces a floorspace requirement that generally sits below both the Experian Baseline and the Regeneration job growth scenarios.

Estimating the Land Requirement

- 8.65 The next step involves translating floorspace into land requirements for industrial and distribution uses. Land requirements have been calculated by applying appropriate plot ratio assumptions to the floorspace estimates. As with the previous 2015 ELFS, it has been assumed that a gross area of 1 ha is required to develop 4,000 sqm of industrial or warehousing / distribution space (equal to a plot ratio of 40%).
- 8.66 The resulting net land requirements for the labour demand and labour supply scenarios are set out in Table 8.15⁹⁵.

⁹⁵ To take an example, the 34,326 sqm B8 net requirement for Rushcliffe identified under the Regeneration job growth projection was increased to reflect the 40% plot ratio and divided by 10,000 to translate square metres (floorspace) into 8.58 ha (land).

Table 8.15 Nottingham Core/Outer HMAs Net Industrial/Warehousing Land Requirements by Scenario (ha)

Scenario Use	1) September Experian			2) March Experian			3) Regeneration			4) 2014-based SNPP			5) SM LHN		
	Light Ind.	B2	B8	Light Ind.	B2	B8	Light Ind.	B2	B8	Light Ind.	B2	B8	Light Ind.	B2	B8
Broxtowe	7.21	1.27	2.99	8.65	2.32	4.49	7.21	2.73	8.58	5.98	-0.08	0.67	6.79	0.78	2.21
Erewash	1.18	-6.69	-1.48	5.00	-5.50	-0.07	1.25	-5.42	5.53	-1.54	-8.45	-3.70	-1.09	-8.07	-3.22
Gedling	7.32	-2.22	6.91	8.72	-2.16	8.41	7.75	-1.69	6.91	10.20	-1.35	10.14	11.37	-1.00	11.46
Nottingham	2.24	-11.35	12.39	6.14	-10.42	21.95	4.72	-7.21	18.21	0.31	-11.78	8.79	6.31	-10.43	19.95
Rushcliffe	4.28	-0.05	-0.09	6.14	1.64	1.50	4.28	-0.01	2.46	2.71	-0.43	-1.37	4.58	0.05	0.33
CORE HMA TOTAL	22.23	-19.04	20.72	34.65	-14.12	36.28	25.21	-11.6	41.69	17.66	-22.09	14.53	27.96	-18.67	30.73
Ashfield	2.89	-13.40	8.20	6.38	-11.62	12.30	3.01	-11.30	13.29	4.92	-12.47	12.09	6.11	-11.93	14.36
<i>(of which located in Hucknall)</i>	0.47	-2.19	1.34	1.04	-1.90	2.01	0.49	-1.85	2.17	1.68	-1.64	3.66	2.01	-1.49	4.29
Mansfield	10.15	-2.95	0.11	11.60	-2.16	1.53	10.15	-2.95	3.02	8.49	-3.58	-0.81	9.09	-3.35	-0.50
Newark & Sherwood	4.50	-1.39	8.69	5.87	-1.31	11.75	4.50	-0.74	11.41	1.73	-3.13	2.23	3.17	-2.22	5.59
OUTER HMA TOTAL	17.54	-17.74	17	23.85	-15.09	25.58	17.66	-14.99	27.72	15.14	-19.18	13.51	18.37	-17.5	19.45

Source: Lichfields analysis

C. Past Take Up Rates

- 8.67 Because they reflect actual development patterns on the ground, in some cases long term completion rates of employment floorspace can provide a reasonable basis for informing future land needs. Completions over such a period as ten years or more should even out demand fluctuations over a business cycle and normally provide a reasonable basis for estimating future need provided land supply has not been unduly constrained or influenced by other policy factors. Whereas job projections show growth in net terms, past trend-based assessments take into account development that offsets the redevelopment of employment sites, and from the recycling of sites.
- 8.68 Monitoring data on past completions by office, industrial (light and general) and distribution uses between 2011/12 and 2019/20 were provided by all 8 Councils. Losses data was also provided over this timeframe to enable a net figure to be calculated. Data before this time period for many of the districts was of a more variable quality and has not been used. However, comparable completions/losses data was provided by Ashfield District and Newark & Sherwood District Councils over a longer time period (going back to 2000/01 and 2009/10 respectively).
- 8.69 The resultant net annual figures are illustrated in Figure 8.4 below. As can be seen in the Figure, a total of 14,665 sqm of gross office floorspace completions has come forward per annum in recent years, with the highest levels in Newark & Sherwood (4,814 sqm p.a.) and Nottingham City (2,752 sqm). In contrast, 18,918 sqm of office floorspace has been lost per annum over that same time period, resulting in a negative net floorspace figure of -4,252 sqm per annum. This is primarily due to very high levels of office floorspace losses in Nottingham City, averaging 11,366 sqm pe annum, which is likely to be due to the high levels of Permitted Development Rights allowing conversions from former B1a/b to

residential without the need for a standard planning application to be submitted.

Figure 8.4 Annual Take-Up of Office Floorspace in the 8 Nottingham HMA districts 2011/12- 2019/20*

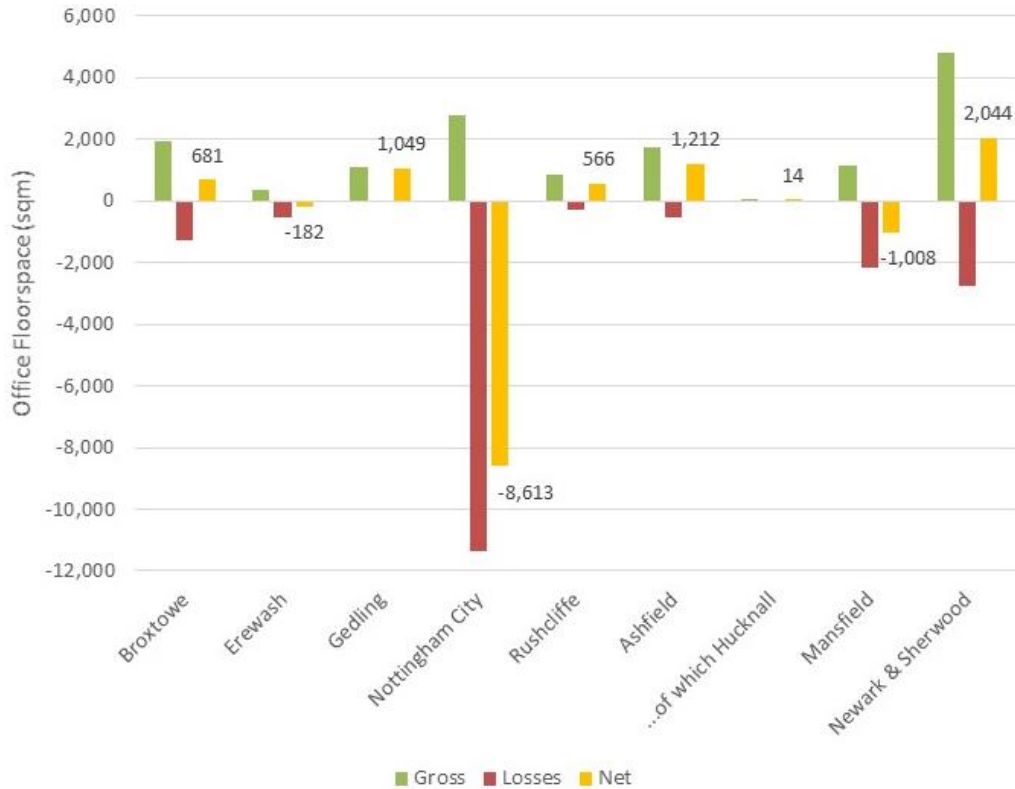

Source: 8 District Councils / Lichfields' Analysis

*Note – timeframe is longer for Ashfield District (2000/01-2019/20) and Newark and Sherwood (2009/10 – 2019/20) due to the availability of robust data

8.70 Figure 8.5 presents the comparable data relating to light industrial, general industrial and distribution floorspace take up (in certain instances the full breakdown by Use Class is not available from the Councils). The data indicates that a total of 55,176 sqm per annum was taken up across the two HMAs per annum in recent years (14,489 sqm in the Core HMA, 40,687 sqm in the Outer HMA), with Ashfield (22,382 sqm p.a.) and Newark & Sherwood (15,216 sqm p.a.) dominating. In terms of losses, these have still been relatively high in recent years, totalling 27,752 sqm, with Nottingham City (-8,686 sqm p.a.) and Ashfield District (-8,406 sqm p.a.) seeing the highest levels.

8.71 In total, these adjustments ensure that the net floorspace delivery rate in the Core HMA totals -3,717 sqm p.a., which is entirely due to Nottingham City's figure of -7,572 sqm (the other 4 districts have modest positive net delivery rates of industrial floorspace). For the Outer HMA, net past take-up averages 31,140 sqm per annum, just under half of which has come forward in Newark & Sherwood.

Figure 8.5 Annual Take-Up of Light Industrial, General Industrial and Distribution Floorspace in the 8 Nottingham HMA districts 2011/12- 2019/20*

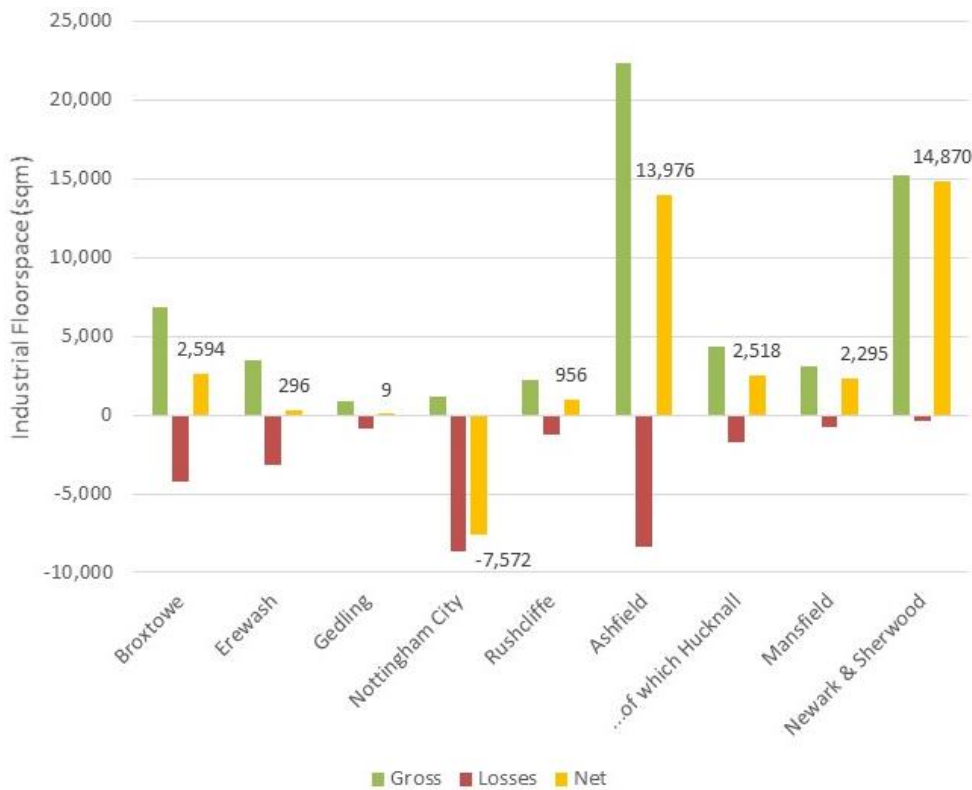

Source: 8 District Councils / Lichfields' Analysis

*Note – timeframe is slightly longer for Ashfield District (2000/01-2019/20) and Newark and Sherwood (2009/10 – 2019/20)

8.72 Table 8.16 presents the net annual take-up for each district by office/industrial use classes and projects this rate forward over the 20-year plan period. Floorspace has been converted to land for industrial/distribution uses through the application of a standard 40% plot ratio.

8.73 The data suggests that if past trends were to be replicated in future, this could justify the provision of around -85,050 sqm (net) less office space across the two HMAs. This equates to -130,002 sqm in the Core HMA, due to the very substantial net loss of -172,269 sqm for Nottingham City, and +44,952 sqm for the Outer HMA districts. In contrast, there is a substantial net increase of 137.12 ha of industrial / distribution land across the 8 districts, of which -18.58 ha relates to the Core HMA (with another very substantial net loss of -37.86 ha for Nottingham City) and + 155.70 ha for the three Outer HMA districts.

Table 8.16 Net Employment Space Requirements Based on Past Completions Trends, 2018-2038

		Annual Net Change	Total Net Land Requirements (2018-2038)
Broxtowe	Office	681 sqm	13,611 sqm
	Industrial / Distribution	0.65 ha	12.97 ha
Erewash	Office	-182 sqm	-3,636 sqm
	Industrial / Distribution	0.07 ha	1.48 ha
Gedling	Office	1,049 sqm	20,972 sqm
	Industrial / Distribution	0.00 ha	0.05 ha
Nottingham	Office	-8,613 sqm	-172,269 sqm
	Industrial / Distribution	-1.89 ha	-37.86 ha
Rushcliffe	Office	566 sqm	11,320 sqm
	Industrial / Distribution	0.24 ha	4.78 ha
Ashfield	Office	1,212 sqm	24,240 sqm
	Industrial / Distribution	3.49 ha	69.88 ha
...of which Hucknall	Office	14 sqm	280 sqm
	Industrial / Distribution	0.63 ha	12.59 ha
Mansfield	Office	-1,008 sqm	-20,155 sqm
	Industrial / Distribution	0.57 ha	11.47 ha
Newark & Sherwood	Office	2,044 sqm	40,872 sqm
	Industrial / Distribution	3.72 ha	74.35 ha

Source: 8 District Councils / Lichfields Analysis

8.74 This approach assumes that past trends of development would continue unchanged, which may not fully reflect changes in the economy as it returns to growth. On the other hand, future development rates for industrial space may be lower than has been achieved historically as the sector rationalises and/or makes more efficient use of space.

8.75 In addition, all of the following must be considered when weighing up whether past take up rates are likely to change significantly in the future:

- 1 The long-term impacts of the economic downturn and uncertainty surrounding Brexit and the Covid-19 Pandemic. Clearly the recession and prolonged economic downturn and uncertainty arising from Brexit and the Covid-19 Pandemic may have a significant impact on development needs over the coming years, although as set out in Section 5.0, most of the commercial agents we spoke to were very surprised at how buoyant the industrial and to a lesser extent, commercial, market has been over the past year despite the three lockdowns, with demand for B8 distribution in particular at record levels and vacancy rates very low as a result.
- 2 The move towards a more Business Services-orientated economy with significantly higher employment densities, although as discussed elsewhere, this may be countered to an extent by the accompanying shift towards higher levels of homeworking and greater flexibility for staff and their working hours;
- 3 The continued restructuring of the traditional manufacturing economy with the potential for 'recycling' of older sites;
- 4 The new 'E' Use Class, which now incorporates the former B1 use class alongside A1 Shops, A2 Financial and Professional Services; A3 Food and Drink; D1 Non-Residential Institutions and D2 Assembly and Leisure. This

will make it considerably easier to switch uses from B1 office, say, to retail without the need for planning permission (although the reverse is also true);

- 5 The significant reduction (or conversely, increase) in public sector spending available to deliver difficult brownfield sites; and,
- 6 The need to consider alternative uses for existing employment sites (i.e. for waste and recycling).

8.76 At the time of writing, it is probably too soon to say how this will play out and it will be vital for all 8 district councils to maintain robust monitoring records and to ensure that their employment land portfolio is as flexible as possible to ensure that it can adapt to the new economic reality.

8.77 **On balance, for the 8 districts it is suggested that the medium-term net change annual past take-up rate represents a robust figure going forward over the remainder of the plan period, particularly given that less accurate and detailed B-Class records are available for many of the Councils before 2011/12 (with the notable exceptions of Ashfield and to a lesser extent, Newark & Sherwood Districts).** This should be regularly monitored by Council Officers and amended as necessary.

8.78 We note that for Ashfield District Council in particular, if the medium-term figure is taken (2011/12-2019/20), this would have a significant reduction in the amount of office floorspace that would be required, with the 20-year net figure decreasing from 24,240 sqm to just 968 sqm. The industrial floorspace net figure would also fall over the medium term, from 69.88 ha to 54.91 ha. If the Council wishes to provide for a lower level of need based on the medium term take up rates, that may be acceptable, but it is something they will need to justify.

Flexibility Factor

8.79 To estimate the overall requirement of employment space that should be planned for in allocating sites, and to allow some flexibility of provision, it is normal to add an allowance as a safety margin for factors such as delays in some sites coming forward for development. This margin, or flexibility factor, is contingency cover, providing a modest additional land buffer so that supply is not too tightly matched to estimated demand, and so that shortages of land do not arise if future demand turns out to be greater than the forecasts. Such flexibility is sensible given the uncertainties in the forecasting process and the scope for delays in developing employment space.⁹⁶

8.80 The former South East England Planning Partnership Board [SEEPB] guidance on employment land assessments recommended an allowance that is equivalent to the average time for a site to gain planning permission and be developed, typically about two years. This equates to two-years of average net take-up⁹⁷ and is considered to be an appropriate level relative to the estimated scale of the original requirement.

⁹⁶ This flexibility factor is separate from the consideration of vacancy rate.

⁹⁷ Note – although net take up has been used where possible, where the figure is negative or zero (as in the case for Gedling), the gross take up has been used.

8.81

For the Core HMA districts, this equates to 10,803 sqm of office floorspace and 3.75 ha of industrial / distribution land⁹⁸. For the Outer HMA districts, this equals 8,801 sqm of office floorspace and 15.57 ha of industrial / distribution land.

Table 8.17 Greater Nottingham HMAs Flexibility Factor Allowances (Net used unless specified)*

		Net Average Annual Take-up	2-year Flexibility Factor Added 2018-2038
Broxtowe	Office	681 sqm	1,361 sqm
	Light Industrial	0.14 ha	0.28 ha
	General Industrial	0.28 ha	0.57 ha
	Distribution	0.23 ha	0.45 ha
Erewash	Office	-182 sqm (354 sqm gross used)	708 sqm
	Light Industrial	-0.13 (0.05 ha gross used)	0.11 ha
	General Industrial	0.06 ha	0.13 ha
	Distribution	0.14 ha	0.28 ha
Gedling	Office	1,049 sqm	2,097 sqm
	Light Industrial	0.00 ha (0.07 ha gross used)	0.14 ha
	General Industrial	0.00 ha (0.09 ha gross used)	0.18 ha
	Distribution	0.00 ha (0.06 ha gross used)	0.12 ha
Nottingham	Office	-8,613 sqm (2,752 sqm gross used)	5,505 sqm
	Light Industrial	-0.61 (0.08 ha gross used)	0.16 ha
	General Industrial	-0.53 (0.09 ha gross used)	0.18 ha
	Distribution	-0.74 (0.11 ha gross used)	0.22 ha
Rushcliffe	Office	566 sqm	1,132 sqm
	Light Industrial	-0.10 ha (0.13 ha gross used)	0.26 ha
	General Industrial	0.09 ha	0.18 ha
	Distribution	0.24 ha	0.49 ha
Ashfield	Office	1,212 sqm	2,424 sqm
	Light Industrial	0.29 ha	0.58 ha
	General Industrial	0.65 ha	1.31 ha
	Distribution	2.55 ha	5.10 ha
...of which Hucknall	Office	14 sqm	28 sqm
	Light Industrial	0.11 ha	0.21 ha
	General Industrial	0.24 ha	0.47 ha
	Distribution	0.29 ha	0.58 ha
Mansfield	Office	-1,008 sqm (1,145 sqm gross used)	2,290 sqm
	Light Industrial	0.25 ha	0.49 ha
	General Industrial	0.06 ha	0.13 ha
	Distribution	0.26 ha	0.53 ha
Newark & Sherwood	Office	2,044 sqm	4,087 sqm
	Light Industrial	0.34 ha	0.68 ha
	General Industrial	1.76 ha	3.52 ha
	Distribution	1.61 ha	3.23 ha

Source: Lichfields Analysis

*Note: For those districts where only an overall mixed industrial/distribution take up /losses figure has been provided by the Council, an indicative split of the overall figure has been derived through the application of the September 2020 Experian Use Class breakdown for 2018.

⁹⁸ For those districts where only an overall mixed industrial/distribution take up /losses figure has been provided by the Council, an indicative split of the overall figure has been derived through the application of the September 2020 Experian Use Class breakdown for 2018.

Net Floorspace / Land Requirements

8.82

Drawing together the results from each of the future economic scenarios together with the sensitivity testing scenarios considered above, the following tables summarise the net floorspace requirements across the Plan period.

Core HMA

Table 8.18 Net Floorspace Requirements for **Broxtowe Borough** (including flexibility factor) for 2018 to 2038

Scenario		Offices / R&D (sqm)	Light Industrial (ha)	General Industrial (ha)	Warehousing (ha)	Total Industrial (ha)
1) Experian September 2020 Baseline	Net	11,065	7.21	1.27	2.99	11.47
	+ Flexibility Factor	12,426	7.49	1.83	3.45	12.77
2) Experian March 2020 Baseline	Net	11,268	8.65	2.32	4.49	15.46
	+ Flexibility Factor	12,629	8.93	2.88	4.95	16.76
3) Regeneration Scenario	Net	17,720	7.21	2.73	8.58	18.52
	+ Flexibility Factor	19,081	7.49	3.30	9.03	19.82
4) 2014-based SNPP	Net	8,281	5.98	-0.08	0.67	6.57
	+ Flexibility Factor	9,642	6.26	0.49	1.13	7.87
5) Current SM (368dpa)	Net	10,125	6.79	0.78	2.21	9.78
	+ Flexibility Factor	11,486	7.07	1.35	2.66	11.08
6) Past Take Up Rates	Net	13,612	2.77	5.66	4.53	12.97
	+ Flexibility Factor	14,973	3.05	6.23	4.99	14.27

Source: Lichfields' analysis
Rounding errors may mean sums do not add.

Table 8.19 Net Floorspace Requirements for **Erewash Borough** (including flexibility factor) for 2018 to 2038

Scenario		Offices / R&D (sqm)	Light Industrial (ha)	General Industrial (ha)	Warehousing (ha)	Total Industrial (ha)
1) Experian September 2020 Baseline	Net	7,913	1.18	-6.69	-1.48	-6.99
	+ Flexibility Factor	8,621	1.29	-6.56	-1.20	-6.47
2) Experian March 2020 Baseline	Net	9,450	5.00	-5.50	-0.07	-0.57
	+ Flexibility Factor	10,157	5.10	-5.37	0.21	-0.06
3) Regeneration Scenario	Net	15,358	1.25	-5.42	5.53	1.35
	+ Flexibility Factor	16,065	1.36	-5.29	5.81	1.87
4) 2014-based SNPP	Net	3,168	-1.54	-8.45	-3.70	-13.69
	+ Flexibility Factor	3,876	-1.43	-8.32	-3.43	-13.17
5) Current SM (392dpa)	Net	4,189	-1.09	-8.07	-3.22	-12.38
	+ Flexibility Factor	4,897	-0.98	-7.94	-2.95	-11.87
6) Past Take Up Rates	Net	-3,636	-2.61	1.30	2.79	1.48
	+ Flexibility Factor	-2,928	-2.50	1.43	3.07	2.00

Source: Lichfields' analysis
Rounding errors may mean sums do not add.

Table 8.20 Net Floorspace Requirements for **Gedling Borough** (including flexibility factor) for 2018 to 2038

Scenario		Offices / R&D (sqm)	Light Industrial (ha)	General Industrial (ha)	Warehousing (ha)	Total Industrial (ha)
1) Experian September 2020 Baseline	Net	5,835	7.32	-2.22	6.91	12.02
	+ Flexibility Factor	7,933	7.46	-2.04	7.03	12.45
1) Experian March 2020 Baseline	Net	5,835	8.72	-2.16	8.41	14.97
	+ Flexibility Factor	7,933	8.86	-1.98	8.53	15.41
3) Regeneration Scenario	Net	8,630	7.75	-1.69	6.91	12.97
	+ Flexibility Factor	10,727	7.89	-1.51	7.03	13.40
4) 2014-based SNPP	Net	8,973	10.20	-1.35	10.14	18.99
	+ Flexibility Factor	11,070	10.34	-1.17	10.26	19.43
5) Current SM (458dpa)	Net	10,248	11.37	-1.00	11.46	21.83
	+ Flexibility Factor	12,345	11.51	-0.82	11.58	22.26
6) Past Take Up Rates	Net	20,972	0.01	0.02	0.01	0.04
	+ Flexibility Factor	23,069	0.15	0.19	0.13	0.48

Source: Lichfields' analysis
Rounding errors may mean sums do not add.

Table 8.21 Net Floorspace Requirements for **Nottingham City** (including flexibility factor) for 2018 to 2038

Scenario		Offices / R&D (sqm)	Light Industrial (ha)	General Industrial (ha)	Warehousing (ha)	Total Industrial (ha)
1) Experian September 2020 Baseline	Net	125,646	2.24	-11.35	12.39	3.28
	+ Flexibility Factor	131,151	2.41	-11.17	12.61	3.84
2) Experian March 2020 Baseline	Net	124,873	6.14	-10.42	21.95	17.67
	+ Flexibility Factor	130,377	6.30	-10.24	22.17	18.23
3) Regeneration Scenario	Net	129,040	4.72	-7.21	18.21	15.72
	+ Flexibility Factor	134,545	4.88	-7.03	18.43	16.28
4) 2014-based SNPP	Net	113,157	0.31	-11.78	8.79	-2.67
	+ Flexibility Factor	118,662	0.48	-11.61	9.01	-2.12
5) Current SM (1,551 dpa)	Net	151,958	6.31	-10.43	19.95	15.83
	+ Flexibility Factor	157,462	6.47	-10.26	20.17	16.38
6) Past Take Up Rates	Net	-172,260	-11.07	-11.91	-14.89	-37.86
	+ Flexibility Factor	-166,755	-10.90	-11.73	-14.67	-37.30

Source: Lichfields' analysis
Rounding errors may mean sums do not add.

Table 8.22 Net Floorspace Requirements for **Rushcliffe Borough** (including flexibility factor) for 2018 to 2038

Scenario		Offices / R&D (sqm)	Light Industrial (ha)	General Industrial (ha)	Warehousing (ha)	Total Industrial (ha)
1) Experian September 2020 Baseline	Net	36,822	4.28	-0.05	-0.09	4.14
	+ Flexibility Factor	37,954	4.53	0.14	0.39	5.06
2) Experian March 2020 Baseline	Net	34,410	6.14	1.64	1.50	9.29
	+ Flexibility Factor	35,542	6.40	1.82	1.99	10.21
3) Regeneration Scenario	Net	36,910	4.28	-0.01	2.46	6.74
	+ Flexibility Factor	38,042	4.53	0.18	2.95	7.66
4) 2014-based SNPP	Net	27,668	2.71	-0.43	-1.37	0.91
	+ Flexibility Factor	28,800	2.96	-0.24	-0.89	1.83
5) Current SM (604dpa)	Net	38,574	4.58	0.05	0.33	4.97
	+ Flexibility Factor	39,706	4.83	0.24	0.82	5.89
6) Past Take Up Rates	Net	11,320	-1.93	1.84	4.87	4.78
	+ Flexibility Factor	12,452	-1.68	2.03	5.35	5.70

Source: Lichfields' analysis
Rounding errors may mean sums do not add.
errors may mean sums do not add.

Table 8.23 Net Floorspace Requirements for **Core HMA Borough** (including flexibility factor) for 2018 to 2038

Scenario		Offices / R&D (sqm)	Light Industrial (ha)	General Industrial (ha)	Warehousing (ha)	Total Industrial (ha)
1) Experian September 2020 Baseline	Net	187,281	22.23	-19.04	20.72	23.92
	+ Flexibility Factor	198,085	23.18	-17.80	22.28	27.65
2) Experian March 2020 Baseline	Net	185,836	34.65	-14.12	36.28	56.82
	+ Flexibility Factor	196,638	35.59	-12.89	37.85	60.55
3) Regeneration Scenario	Net	207,658	25.21	-11.60	41.69	55.30
	+ Flexibility Factor	218,460	26.15	-10.35	43.25	59.03
4) 2014-based SNPP	Net	161,247	17.66	-22.09	14.53	10.11
	+ Flexibility Factor	172,050	18.61	-20.85	16.08	13.84
5) Current SM (604dpa)	Net	215,094	27.96	-18.67	30.73	40.03
	+ Flexibility Factor	225,896	28.90	-17.43	32.28	43.74
6) Past Take Up Rates	Net	-129,992	-12.83	-3.09	-2.69	-18.59
	+ Flexibility Factor	-119,189	-11.88	-1.85	-1.13	-14.85

Source: Lichfields' analysis
Rounding errors may mean sums do not add.

Outer HMA

Table 8.24 Net Floorspace Requirements for **Ashfield District** (including flexibility factor) for 2018 to 2038

Scenario		Offices / R&D (sqm)	Light Industrial (ha)	General Industrial (ha)	Warehousing (ha)	Total Industrial (ha)
1) Experian September 2020 Baseline	Net	10,914	2.89	-13.40	8.20	-2.31
	+ Flexibility Factor	13,338	3.48	-12.09	13.29	4.68
2) Experian March 2020 Baseline	Net	10,741	6.38	-11.62	12.30	7.06
	+ Flexibility Factor	13,165	6.97	-10.31	17.39	14.05
3) Regeneration Scenario	Net	20,972	3.01	-11.30	13.29	5.00
	+ Flexibility Factor	23,396	3.59	-10.00	18.39	11.98
4) 2014-based SNPP	Net	13,781	4.92	-12.47	12.09	4.54
	+ Flexibility Factor	16,205	5.51	-11.16	17.18	11.53
5) Current SM (481 dpa)	Net	15,456	6.11	-11.93	14.36	8.54
	+ Flexibility Factor	17,880	6.70	-10.62	19.46	15.53
6) Past Take Up Rates	Net	24,240	5.85	13.08	50.96	69.88
	+ Flexibility Factor	26,664	6.43	14.38	56.05	76.87

Source: Lichfields' analysis
Rounding errors may mean sums do not add.

Table 8.25 Net Floorspace Requirements for **Hucknall** (including flexibility factor) for 2018 to 2038

Scenario		Offices / R&D (sqm)	Light Industrial (ha)	General Industrial (ha)	Warehousing (ha)	Total Industrial (ha)
1) Experian September 2020 Baseline	Net	1,785	0.47	-2.19	1.34	-0.38
	+ Flexibility Factor	1,813	0.68	-1.72	1.92	0.88
2) Experian June 2020 Baseline	Net	1,757	1.04	-1.90	2.01	1.16
	+ Flexibility Factor	1,785	1.25	-1.43	2.59	2.41
3) Regeneration Scenario	Net	3,431	0.49	-1.85	2.17	0.82
	+ Flexibility Factor	3,459	0.70	-1.38	2.75	2.08
4) 2014-based SNPP	Net	3,493	1.68	-1.64	3.66	3.70
	+ Flexibility Factor	3,521	1.89	-1.17	4.24	4.96
5) Current SM	Net	3,960	2.01	-1.49	4.29	4.82
	+ Flexibility Factor	3,988	2.23	-1.02	4.87	6.07
6) Past Take Up Rates	Net	280	2.10	4.71	5.78	12.59
	+ Flexibility Factor	308	2.31	5.18	6.36	13.85

Source: Lichfields' analysis
Rounding errors may mean sums do not add.

Table 8.26 Net Floorspace Requirements for **Mansfield District** (including flexibility factor) for 2018 to 2038

Scenario		Offices / R&D (sqm)	Light Industrial (ha)	General Industrial (ha)	Warehousing (ha)	Total Industrial (ha)
1) Experian September 2020 Baseline	Net	8,915	10.15	-2.95	0.11	7.30
	+ Flexibility Factor	11,206	10.64	-2.82	0.64	8.45
2) Experian June 2020 Baseline	Net	8,343	11.60	-2.16	1.53	10.97
	+ Flexibility Factor	10,634	12.09	-2.03	2.06	12.12
3) Regeneration Scenario	Net	11,348	10.15	-2.95	3.02	10.21
	+ Flexibility Factor	13,638	10.64	-2.82	3.55	11.36
4) 2014-based SNPP	Net	6,264	8.49	-3.58	-0.81	4.11
	+ Flexibility Factor	8,555	8.98	-3.45	-0.28	5.25
5) Current SM (275dpa)	Net	7,216	9.09	-3.35	-0.50	5.23
	+ Flexibility Factor	9,506	9.58	-3.23	0.03	6.38
6) Past Take Up Rates	Net	-20,155	4.91	1.28	5.29	11.47
	+ Flexibility Factor	-17,865	5.40	1.41	5.82	12.62

Source: Lichfields' analysis
Rounding errors may mean sums do not add.

Table 8.27 Net Floorspace Requirements for **Newark & Sherwood District** (including flexibility factor) for 2018 to 2038

Scenario		Offices / R&D (sqm)	Light Industrial (ha)	General Industrial (ha)	Warehousing (ha)	Total Industrial (ha)
1) Experian September 2020 Baseline	Net	13,806	4.50	-1.39	8.69	11.80
	+ Flexibility Factor	17,893	5.18	2.14	11.92	19.24
2) Experian June 2020 Baseline	Net	12,573	5.87	-1.31	11.75	16.31
	+ Flexibility Factor	16,660	6.55	2.22	14.98	23.74
3) Regeneration Scenario	Net	20,209	4.50	-0.74	11.41	15.17
	+ Flexibility Factor	24,296	5.18	2.78	14.64	22.61
4) 2014-based SNPP	Net	7,093	1.73	-3.13	2.23	0.83
	+ Flexibility Factor	11,180	2.41	0.40	5.46	8.27
5) Current SM (494dpa)	Net	10,588	3.17	-2.22	5.59	6.55
	+ Flexibility Factor	14,675	3.86	1.30	8.82	13.98
6) Past Take Up Rates	Net	40,872	6.82	35.23	32.30	74.35
	+ Flexibility Factor	44,959	7.50	38.76	35.53	81.78

Source: Lichfields' analysis
Rounding errors may mean sums do not add.
errors may mean sums do not add.

Table 8.28 Net Floorspace Requirements for **Outer HMA** (including flexibility factor) for 2018 to 2038

Scenario		Offices / R&D (sqm)	Light Industrial (ha)	General Industrial (ha)	Warehousing (ha)	Total Industrial (ha)
1) Experian September 2020 Baseline	Net	33,635	17.54	-17.74	17.00	16.79
	+ Flexibility Factor	42,437	19.30	-12.77	25.85	32.37
2) Experian March 2020 Baseline	Net	31,657	23.85	-15.09	25.58	34.34
	+ Flexibility Factor	40,459	25.61	-10.12	34.43	49.91
3) Regeneration Scenario	Net	52,529	17.66	-14.99	27.72	30.38
	+ Flexibility Factor	61,330	19.41	-10.04	36.58	45.95
4) 2014-based SNPP	Net	27,138	15.14	-19.18	13.51	9.48
	+ Flexibility Factor	35,940	16.90	-14.21	22.36	25.05
5) Current SM (604dpa)	Net	33,260	18.37	-17.50	19.45	20.32
	+ Flexibility Factor	42,061	20.14	-12.55	28.31	35.89
6) Past Take Up Rates	Net	44,957	17.58	49.59	88.55	155.70
	+ Flexibility Factor	53,758	19.33	54.55	97.40	171.27

Source: Lichfields' analysis
Rounding errors may mean sums do not add.

Planning Requirements

- 8.83 While the net employment space requirements presented above represent the minimum recommended quantum of employment space to plan for in the Core and Outer Nottingham HMAs over the plan period, the councils will need to take a view on the extent to which additional space should be planned for over and above the net requirements, in order to allow for replacement of ongoing losses of employment space during the Local Plan period.
- 8.84 Determining an appropriate scale of re-provision is a judgement for the councils to make to align with their particular economic growth and strategic policy considerations. Nevertheless, there are a number of data sources that can be scrutinised to provide some guidance as to what an appropriate level of re-provision might be. These include identifying how much employment land is in the pipeline to be lost to alternative uses (from reviewing extant planning applications and SHLAAs); reviewing past trends and assessing whether this is likely to continue for the foreseeable future; and a 'rule of thumb' approaching looking at the size of the local property market and the extent to which there needs to be an element of replacement of a certain proportion of the current commercial/industrial stock to ensure that portfolio does not become increasingly obsolete.
- 8.85 A detailed overview of these data sources and the scale of loss replacement this could point to is provided in Appendix 1.

Conclusions on the Scale of Loss Replacement

Core HMA:

- 1 **Broxtowe:** Council Officers were unable to identify any SHLAA sites or commitments that would result in the substantial loss of employment land/floorspace over the coming years, although the Policies Maps for BBC's Part 2 Local Plan) show several 'Housing Commitments' at employment sites. Many of these are small, but they do include some larger ones, including the Boots site. BBC Officers confirmed that these have already been taken into account in the calculations. As a result, and given the size of the local economy, past trends losses appear on the high side (1,276 sqm p.a. for office; 4,263 sqm p.a. for industrial / warehousing) and particularly so for office replacement. It is considered that on this basis, a lower level of replacement could potentially be justified.

To bring this back into balance, it is recommended that the mid-point of the past trend losses (1,276 sqm p.a. of offices and 4,263 sqm p.a. industrial) and the adjusted 1% replacement of stock (560 sqm office, 3,232 sqm industrial), is projected forward over the plan period. **This equates to the replacement of 918 sqm of offices and 3,747 sqm of industrial / warehousing floorspace per annum;**

- 2 **Erewash:** Past trends industrial losses appear low based on the size of the local economy, at 3,177 sqm per annum, compared to 7,632 sqm if 1% of existing floorspace was replaced, which could suggest that a higher loss replacement could be appropriate. As set out above, the Council has

identified a very substantial amount of land that is likely to be lost going forward. In total 67.18 ha is earmarked to be lost over the next few years across 25 sites.

Of this total, the bulk relates to just one site – the 44.7 ha West Hallam Industrial Park and Storage Depot, which is projected to be lost in 6-10 years' time. This is identified by the Council as having the potential to accommodate up to 1,000 dwellings. It forms one of the Council's proposed housing growth allocation sites it has consulted on as part of its Regulation 18 Growth Options consultation (January 2020) which would replace the 2014 adopted Erewash Core Strategy. This level of loss would equate to 3.93 ha per annum over the next 15 years, or approximately 15,720 sqm per annum, the vast majority of which is likely to relate to B2 and B8 logistics. Clearly not all of this needs to be replaced, but equally there will be a need to provide some replacement logistics facilities in particular if the existing, and occupied, West Hallam Storage Depot is to be closed and the occupiers decanted elsewhere.

On balance, it is recommended that the current loss replacement rate of **536 sqm per annum** be taken forward for office floorspace (or 10,711 sqm over 20 years), as this is in line with the level that might be expected given the volume of office floorspace currently located in the Borough (which would suggest a replacement figure of 480 sqm based on 1% churn in the existing commercial stock). As for industrial floorspace, the current replacement rate is considered insufficient given the large-scale losses likely to come forward. A figure of **7,632 sqm per annum of industrial floorspace replacement** is recommended (152,640 sqm over the plan period), which is equal to the 1% (adjusted) loss replacement of stock, and equal to around half of the potential losses identified over the next 15 years in the SHLAA.

- 3 **Gedling:** Past trends losses appear very low based on the size of the local economy, with just 21 sqm of office floorspace lost per annum over the past 9 years, when a churn replacement of 376 sqm might be more appropriate given the (still small) commercial office market in the Borough. Similarly, just 858 sqm of industrial/warehousing floorspace has been lost per annum in recent years, well below the 3,720 sqm that might be expected based on VOA churn data. This could suggest that a higher loss replacement could be appropriate, which would be supported by the scale of losses likely to be lost due to extant permissions and the SHLAA data, which indicates that 10.45 ha (41,880 sqm) could be lost in the foreseeable future, or around 2,100 sqm per annum over the next 20 years. Whilst not all of the sites have an existing employment use currently operating at present and therefore would not require companies to be decanted onto alternative sites in the Borough, the plan period runs to 2038 and it is very unlikely that there will be no windfall losses over the next 17 years or so.

For this reason, and given the need to ensure a degree of flexibility (in light of agent comments that the limited availability of sites in the past has depressed delivery), it is recommended that the current SHLAA estimation of losses is replaced over the plan period (c. **2,100 sqm/annum or 42,000 sqm in total over 20 years**). This is also reasonably close to the

mid-point between the recorded losses (879 sqm p.a.) and the 1% churn figure (4,096 sqm p.a.). Taking the current split of existing stock, this equates to the replacement of around 193 sqm p.a. of office floorspace and 1,907 sqm p.a. of industrial/warehousing floorspace.

- 4 **Nottingham City:** Past trend losses (11,366 sqm p.a. for office; 8,686 sqm p.a. for industrial / warehousing) do not appear unreasonable and are a close match (overall) with the 1% churn replacement factor, which suggests it is in line with the level of replacement that would be expected given the size of the local economy. However, we note the sites identified by Officers as likely to be lost both to residential (in the SHLAA) and non-residential uses. At 10,700 sqm p.a. (split 3,000 sqm for office, 7,700 sqm for warehousing / industrial), this is around half the level that might be expected based on past losses and the size of the local economy. It is also significantly below the 18,034 sqm loss replacement assumed in the 2015 ELR (which itself was based on halving past losses).

On balance, it is considered that a continuation of past losses could result in an over-provision of land, whilst the SHLAA/officer recommendation alone may be insufficient given the size of the local economy and the age of the existing stock. As such it is recommended that the mid-point of the past losses and Officer estimated losses be taken forward in this instance (15,376 sqm pa, which is similar to the previous replacement level in the 2015 ELR): **office: 7,183 sqm p.a.**, or 143,658 sqm over 20 years; **industrial / warehousing: 8,193 sqm p.a.** (2.05 ha), or 163,860 sqm over 20 years (40.97 ha).

- 5 **Rushcliffe:** Past trends losses appear low (267 sqm p.a. for office; 1,222 sqm p.a. for industrial/warehousing) based on the size of the local economy, which could suggest that a higher loss replacement could be appropriate (perhaps even three times as high). The new broader E-class and PD rights may also accelerate losses above past trends in the Borough. However, as a counter this argument is the fact that the Council has not identified any employment sites that could potentially be lost to residential uses in the SHLAA, and a low level of replacement would be consistent with that recommended in the 2015 ELR.

On balance it is recommended that in the absence of data on specific future losses from the Council, the mid-point of the past losses and adjusted 1% churn be taken forward in this instance: **office: 614 sqm p.a.**, or 12,272 sqm over 20 years; **industrial / warehousing: 2,451 sqm p.a. (0.61 ha)**, or 49,022 sqm over 20 years (12.26 ha).

Outer HMA:

- 6 **Ashfield:** Past trends office and industrial losses (528 sqm / 8,406 sqm respectively) appear reasonable when compared with the size of the local economy (856 sqm / 9,872 sqm based on adjusted 1% replacement annually and netting off a further 20% for recycled employment use). Furthermore, 8.104 ha (c.32,416 sqm @ 40% plot ratio) of existing industrial land already has extant permission to be developed for alternative uses. A further 5.02

ha (c.20,080 sqm @ 40% plot ratio) is currently subject to planning applications for alternative uses.

Officers have commented that a significant part of the losses will reflect employment land which was formally occupied by traditional textile firms and former coal mines. Officers consider that these are sites that are unlikely to be replicated to the same extent in the future as they were purpose-built traditional buildings rather than ‘sheds’ which are far more flexible in terms of future use. Consequently, the ELFS 2015 set out the following commentary:

“For Ashfield there appears to be a mismatch between the high levels of losses experienced since 2001/02 (of 2.18 ha industrial land and 1,396 sqm office floorspace annually) and future commitments / potential SHLAA sites, at 0.77ha. On this basis, it appears reasonable to reduce both the past losses of office floorspace and industrial land in Ashfield by a half.”

[para 5.84]

The data on losses received since the previous ELFS (August 2015) was undertaken, covering a 6-year period of new data from 2014/15 onwards (the 2015 ELFS only had access to data up to 2013/14), indicates that 13.19 ha of (primarily industrial) land was lost to alternative uses at an average of 2.20 ha per annum (8,793 sqm p.a.). This is broadly in line with the long-term average stretching back to 2000/01 (2.23 ha / 8,934 sqm p.a.).

Whilst accepting that ‘only’ 8.1 ha (32,416 sqm) of existing employment sites are presently earmarked to be lost, with the potential for a further 5.02 ha given current applications in the pipeline (13.12 ha in total), there are clearly uncertainties regarding the extent to which the new E Class will result in the loss of more former B1a office and, more relevantly perhaps for Ashfield District, former B1c to non-employment uses.

It is considered that it may be appropriate for the past trend losses of 8,934 sqm to be projected forward over the plan period, split **528 sqm for office and 8,406 sqm (2.1 ha) for industrial / warehousing per annum.**

This would equate to 26 sqm per annum of office and 1,772 sqm (0.443 ha) per annum of industrial / warehousing loss replacement for Hucknall.

However, if the Council wishes to provide for a lower level of loss replacement, that may be acceptable, but it is something they will need to justify. It is appreciated that this has to be balanced with other plan objectives.

- 7 **Mansfield:** Past trends industrial losses appear low based on the size of the local economy (4,680 sqm pa based on 1% replacement, compared to 794 sqm based on past losses) and the fact that 3.89 ha of existing industrial land already has extant permission to be developed for alternative uses as of 31st March 2019. Conversely, the past trend of office losses looks to be on the high side which could suggest that a lower loss replacement could be appropriate. As of 2018/19, the amount of committed employment floorspace approved for change of use was 1,302 sqm of office and 3.89 ha of industrial land.

It is recommended that to bring this back into balance, the mid-point of the past trends losses of 2,947 sqm and the 1% replacement of stock (5,432 sqm) is projected forward over the plan period. This equates to 4,189.5 sqm per annum (split **1,452.4 sqm for office and 2,737.1 sqm for industrial / distribution**) and compares to the 16,862 sqm that is already in the pipeline to be lost from the employment land portfolio.

- 8 **Newark & Sherwood:** The SHELAA data suggests that around 23 ha (around 92,000 sqm) could be lost to residential uses across five existing employment sites in the years ahead. Past trends industrial loss completions appear very low based on the size of the local economy (6,936 sqm pa based on 1% replacement, compared to just 346.5 sqm based on past losses). This is supported by the analysis of the VOA data which suggests that industrial losses may have been significantly under-reported in recent years. Conversely, the past trend of office completions looks to be on the high side (752 sqm pa based on 1% replacement, compared to 2,770 sqm based on past losses) which could suggest that a lower loss replacement could be appropriate.

It is recommended that to bring this back into balance, the mid-point of the past trends losses of 3,117 sqm and the 1% replacement of stock (7,688 sqm) is projected forward over the plan period. **This equates to 5,402 sqm, split 1,761 sqm for office and 3,641 sqm for industrial/warehousing (0.91 ha) per annum.** This would equate to around 27 ha over the 20-year Plan period, which is only moderately above the 23 ha that the SHELAA has already identified as being suitable for release to residential uses alone.

Planning Requirement Results

- 8.86 In interpreting the outputs of this section, regard should be had to guidance from the PPG, which states that local authorities should develop an idea of the future economic needs of their area based on a range of data and forecasts of quantitative and qualitative requirements. In this respect, planning for growth should avoid relying upon using single sources of data or forecasts which tend to rely on a number of different variables that are inevitably subject to change.
- 8.87 It is also important to recognise that there are inevitable uncertainties and limitations related to modelling assumptions under any of the future scenarios of growth considered in this study. For example, there are some inherent limitations to the use of local level economic projections, particularly within the context of significant economic uncertainty at both macro and local level. Employment forecasts are regularly updated, and the resulting employment outputs will change over the plan period for the 8 Nottingham HMA districts.
- 8.88 This assessment considers six different scenarios of future employment space requirements in the Nottingham Core/Outer HMA based on a number of approaches that reflect economic growth, past development patterns, and potential housing supply factors:

- 1 The baseline Experian September 2020 scenario reflects a forecast view of the ‘ambient’ level of future growth in the economy based on the sector mix within the local economy and the area’s relationship to broader macroeconomic assumptions. As noted earlier, this factors in Experian’s latest assumptions regarding the negative economic impacts of the Pandemic and Brexit; it did not anticipate a third lockdown. This represents the starting point for assessing future business needs, but it is likely to be a pessimistic model.
- 2 The baseline Experian March 2020 scenario mirrors Scenario 1, albeit it was undertaken before the full economic shock of the Covid-19 pandemic was fully realised. As a result, and for every district, the economic growth projections are significantly more optimistic, with a knock-on effect for the land requirements.
- 3 The Regeneration, or ‘policy on’ scenario, reflects an assumption of higher future economic growth in line with LEP objectives and linked to delivery of a range of sector-specific growth interventions. This results in a significant uplift over and above the baseline position. This scenario provides a theoretical assessment of potential future economic growth and does not take account of potential market demand or delivery factors. It is also possible that a share of this growth potential is already captured within the baseline forecast. Therefore, this scenario should be regarded as a yardstick of future economic potential in line with the LEP’s policy aspirations (and the investments and interventions that flow from these) rather than a prescriptive requirement for planning purposes.
- 4 The 2014-based SNPP labour supply-based estimate provides a useful benchmark for comparison with the labour demand approaches and produces a floorspace requirement that sits between the past completions and ‘policy on’ job growth scenario. These are often significantly lower than the econometric modelling and is a stress test as to whether the local labour supply is likely to be sufficient to meet each district’s economic growth aspirations.
- 5 The current Standard Method scenario factors in the 2014-based SNPP but assumes that the additional homes associated with the Affordability Ratio uplift will ‘inflate’ the population of the authority area on a proportional basis, although there are issues concerning the extent to which this will really result in new households moving into the area, or whether it will just free up housing for concealed households; conversely, migration rates might also be expected to attract higher levels of economically active residents into the area. Given this uncertainty this sensitivity test should therefore be taken as a theoretical upper end of any range taken forward by the eight Councils.
- 6 The final past take-up scenario trends forward development levels experienced in the recent past, and is based on more robust and comprehensive data than was available at the time of the 2015 ELFS (hence greater weight can be attached as a consequence).

- 8.89 The following tables set out the modelling results, for both net and (indicative) gross figures, although for the latter it will be for the respective Councils to make a balanced judgement as to the scale of loss replacement, based on policy aspirations and the latest available monitoring data.

Core HMA

- 8.90 Broxtowe Borough's net employment land needs range from 8,424 sqm of office floorspace and 6.21 ha of industrial / warehousing land under the 2014-based SNPP scenario, up to 19,081 sqm office / 19.82 ha of industrial land for the Regeneration Scenario (although the past take up rates suggest a much higher office need, of 14,973 sqm, and a much lower industrial land requirement of 14.27 ha).
- 8.91 The gross requirements increase the range to between 26,788 sqm and 37,445 sqm for office floorspace, and to between 24.95 ha and 38.56 ha for industrial land over the 20-year plan period.

Table 8.29 Gross Floorspace Requirements for **Broxtowe Borough** (including flexibility factor and losses) for 2018 to 2038

Scenario		Offices / R&D (sqm)	Light Industrial (ha)	General Industrial (ha)	Warehousing (ha)	Total Industrial (ha)
1) Experian September 2020 Baseline	Net	11,065	7.21	1.27	2.99	11.47
	+ Flexibility Factor	12,426	7.49	1.83	3.45	12.77
	+ Loss Replacement	30,790	11.49	10.01	10.00	31.50
2) Experian September 2020 Baseline	Net	11,268	8.65	2.32	4.49	15.46
	+ Flexibility Factor	12,629	8.93	2.88	4.95	16.76
	+ Loss Replacement	30,993	12.93	11.07	11.50	35.50
3) Regeneration Scenario	Net	17,720	7.21	2.73	8.58	18.52
	+ Flexibility Factor	19,081	7.49	3.30	9.03	19.82
	+ Loss Replacement	37,445	11.49	11.48	15.59	38.56
4) 2014-based SNPP	Net	8,281	5.98	-0.08	0.67	6.57
	+ Flexibility Factor	9,642	6.26	0.49	1.13	7.87
	+ Loss Replacement	28,006	10.26	8.67	7.68	26.61
5) Current SM (368 dpa)	Net	10,125	6.79	0.78	2.21	9.78
	+ Flexibility Factor	11,486	7.07	1.35	2.66	11.08
	+ Loss Replacement	29,850	11.08	9.53	9.22	29.82
6) Past Take Up Rates	Net	13,612	2.77	5.66	4.53	12.97
	+ Flexibility Factor	14,973	3.05	6.23	4.99	14.27
	+ Loss Replacement	33,337	7.05	14.41	11.54	33.00

Source: Lichfields' analysis
Rounding errors may mean sums do not add.

- 8.92 Erewash Borough's net employment land needs range from 3,876 sqm of office floorspace and -13.17 ha of industrial / warehousing land under the 2014-based SNPP scenario, up to 16,065 sqm office / 1.87 ha of industrial land for the Regeneration Scenario (although the past take up rates suggest a much lower office need, of -2,928 sqm, and a higher industrial land requirement of 2.00 ha).
- 8.93 The gross requirements increase the range to between 14,587 sqm and 26,776 sqm for office floorspace, and to between 24.99 ha and 40.16 ha for industrial land over 20 years.

Table 8.30 Gross Floorspace Requirements for **Erewash Borough** (including flexibility factor and losses) for 2018 to 2038

Scenario		Offices / R&D (sqm)	Light Industrial (ha)	General Industrial (ha)	Warehousing (ha)	Total Industrial (ha)
1) Experian September 2020 Baseline	Net	7,913	1.18	-6.69	-1.48	-6.99
	+ Flexibility Factor	8,621	1.29	-6.56	-1.20	-6.47
	+ Loss Replacement	19,332	10.16	9.80	11.73	31.69
2) Experian March 2020 Baseline	Net	9,450	5.00	-5.50	-0.07	-0.57
	+ Flexibility Factor	10,157	5.10	-5.37	0.21	-0.06
	+ Loss Replacement	20,869	13.98	10.99	13.14	38.10
3) Regeneration Scenario	Net	15,358	1.25	-5.42	5.53	1.35
	+ Flexibility Factor	16,065	1.36	-5.29	5.81	1.87
	+ Loss Replacement	26,776	10.23	11.07	18.73	40.03
4) 2014-based SNPP	Net	3,168	-1.54	-8.45	-3.70	-13.69
	+ Flexibility Factor	3,876	-1.43	-8.32	-3.43	-13.17
	+ Loss Replacement	14,587	7.44	8.05	9.50	24.99
5) Current SM (392 dpa)	Net	4,189	-1.09	-8.07	-3.22	-12.38
	+ Flexibility Factor	4,897	-0.98	-7.94	-2.95	-11.87
	+ Loss Replacement	15,608	7.89	8.43	9.98	26.29
6) Past Take Up Rates	Net	-3,636	-2.61	1.30	2.79	1.48
	+ Flexibility Factor	-2,928	-2.50	1.43	3.07	2.00
	+ Loss Replacement	7,783	6.37	17.79	16.00	40.16

Source: Lichfields' analysis
Rounding errors may mean sums do not add.

- 8.94 Gedling Borough's net employment land needs (incorporating a 2-year flexibility factor) range from 7,933 sqm of office floorspace and 12.45 ha of industrial / warehousing land under the Experian September 2020 Baseline scenario (although the office need is mirrored with the earlier, pre-Covid March 2020 Experian model run). The upper end of the net requirement increases to 12,345 sqm office and 22.26 ha of industrial land for the Current Standard Method (458 dpa) labour supply scenario. As with Broxtowe, the past take-up rates for Gedling suggest a much higher office need, of 23,069 sqm, and a lower industrial land requirement of just 0.48 ha.
- 8.95 The gross requirements increase the range to between 11,789 sqm and 26,925 sqm for office floorspace, to between 10.01 ha and 31.8 ha for industrial land to 2038.

Table 8.31 Gross Floorspace Requirements for **Gedling Borough** (including flexibility factor and losses) for 2018 to 2038

Scenario		Offices / R&D (sqm)	Light Industrial (ha)	General Industrial (ha)	Warehousing (ha)	Total Industrial (ha)
1) Experian September 2020 Baseline	Net	5,835	7.32	-2.22	6.91	12.02
	+ Flexibility Factor	7,933	7.46	-2.04	7.03	12.45
	+ Loss Replacement	11,789	10.50	1.83	9.66	21.98
2) Experian March 2020 Baseline	Net	5,835	8.72	-2.16	8.41	14.97
	+ Flexibility Factor	7,933	8.86	-1.98	8.53	15.41
	+ Loss Replacement	11,789	11.89	1.89	11.15	24.94
3) Regeneration Scenario	Net	8,630	7.75	-1.69	6.91	12.97
	+ Flexibility Factor	10,727	7.89	-1.51	7.03	13.40
	+ Loss Replacement	14,583	10.92	2.36	9.66	22.94
4) 2014-based SNPP	Net	8,973	10.20	-1.35	10.14	18.99
	+ Flexibility Factor	11,070	10.34	-1.17	10.26	19.43
	+ Loss Replacement	14,926	13.37	2.70	12.89	28.96
5) Current SM (458 dpa)	Net	10,248	11.37	-1.00	11.46	21.83
	+ Flexibility Factor	12,345	11.51	-0.82	11.58	22.26
	+ Loss Replacement	16,201	14.54	3.05	14.20	31.80
6) Past Take Up Rates	Net	20,972	0.01	0.02	0.01	0.04
	+ Flexibility Factor	23,069	0.15	0.19	0.13	0.48
	+ Loss Replacement	26,925	3.19	4.07	2.76	10.01

Source: Lichfields' analysis
Rounding errors may mean sums do not add.

- 8.96 Nottingham City's net employment land needs (incorporating a 2-year flexibility factor) range from -166,755 sqm of office floorspace and -37.30 ha of industrial / warehousing land under the Past Take-Up Rates scenario, whilst the upper end of the net requirement increases to 157,462 sqm of office and 16.38 ha of industrial land for the SM scenario.
- 8.97 The gross requirements increase the range to between -23,097 sqm and 301,120 sqm for office floorspace, and to between 3.66 ha and 59.19 ha for industrial land to 2038. In this instance, the past take-up rates for Nottingham City appear to be very much an outlier compared to the other scenarios, due to the very high levels of losses in recent years and the comparatively low levels of industrial completions. If this scenario is excluded, the range would settle at between 262,320 sqm and 301,120 sqm for office floorspace (gross), and between 38.85 ha and 59.19 ha of industrial land (gross).

Table 8.32 Gross Floorspace Requirements for Nottingham City (including flexibility factor and losses) for 2018 to 2038

Scenario		Offices / R&D (sqm)	Light Industrial (ha)	General Industrial (ha)	Warehousing (ha)	Total Industrial (ha)
1) Experian September 2020 Baseline	Net	125,646	2.24	-11.35	12.39	3.28
	+ Flexibility Factor	131,151	2.41	-11.17	12.61	3.84
	+ Loss Replacement	274,809	14.38	1.71	28.71	44.80
2) Experian March 2020 Baseline	Net	124,873	6.14	-10.42	21.95	17.67
	+ Flexibility Factor	130,377	6.30	-10.24	22.17	18.23
	+ Loss Replacement	274,035	18.28	2.64	38.28	59.19
3) Regeneration Scenario	Net	129,040	4.72	-7.21	18.21	15.72
	+ Flexibility Factor	134,545	4.88	-7.03	18.43	16.28
	+ Loss Replacement	278,203	16.86	5.85	34.54	57.24
4) 2014-based SNPP	Net	113,157	0.31	-11.78	8.79	-2.67
	+ Flexibility Factor	118,662	0.48	-11.61	9.01	-2.12
	+ Loss Replacement	262,320	12.45	1.28	25.12	38.85
5) Current SM (1,551 dpa)	Net	151,958	6.31	-10.43	19.95	15.83
	+ Flexibility Factor	157,462	6.47	-10.26	20.17	16.38
	+ Loss Replacement	301,120	18.44	2.62	36.28	57.35
6) Past Take Up Rates	Net	-172,260	-11.07	-11.91	-14.89	-37.86
	+ Flexibility Factor	-166,755	-10.90	-11.73	-14.67	-37.30
	+ Loss Replacement	-23,097	1.07	1.15	1.44	3.66

Source: Lichfields' analysis
Rounding errors may mean sums do not add.

- 8.98 Rushcliffe Borough's net employment land needs (incorporating a 2-year flexibility factor) range from 28,800 sqm of office floorspace and 1.83 ha of industrial / warehousing land under the 2014-based SNPP labour supply scenario up to 38,042 sqm office and 7.66 ha of industrial land for the Regeneration Scenario. The past take-up rates suggest a much lower level of office need, of just 12,452 sqm, and a higher industrial land requirement of 5.70 ha.
- 8.99 The gross requirements increase the range to between 24,724 sqm and 51,978 sqm for office floorspace, and between 14.09 ha and 22.46 ha for industrial land to 2038.

Table 8.33 Gross Floorspace Requirements for **Rushcliffe Borough** (including flexibility factor and losses) for 2018 to 2038

Scenario		Offices / R&D (sqm)	Light Industrial (ha)	General Industrial (ha)	Warehousing (ha)	Total Industrial (ha)
1) Experian September 2020 Baseline	Net	36,822	4.28	-0.05	-0.09	4.14
	+ Flexibility Factor	37,954	4.53	0.14	0.39	5.06
	+ Loss Replacement	50,226	13.45	0.36	3.51	17.32
2) Experian March 2020 Baseline	Net	34,410	6.14	1.64	1.50	9.29
	+ Flexibility Factor	35,542	6.40	1.82	1.99	10.21
	+ Loss Replacement	47,814	15.31	2.05	5.11	22.46
3) Regeneration Scenario	Net	36,910	4.28	-0.01	2.46	6.74
	+ Flexibility Factor	38,042	4.53	0.18	2.95	7.66
	+ Loss Replacement	50,314	13.45	0.40	6.07	19.91
4) 2014-based SNPP	Net	<u>27,668</u>	<u>2.71</u>	<u>-0.43</u>	<u>-1.37</u>	<u>0.91</u>
	+ Flexibility Factor	<u>28,800</u>	<u>2.96</u>	<u>-0.24</u>	<u>-0.89</u>	<u>1.83</u>
	+ Loss Replacement	<u>41,072</u>	<u>11.87</u>	<u>-0.02</u>	<u>2.23</u>	<u>14.09</u>
5) Current SM (604 dpa)	Net	<u>38,574</u>	<u>4.58</u>	<u>0.05</u>	<u>0.33</u>	<u>4.97</u>
	+ Flexibility Factor	<u>39,706</u>	<u>4.83</u>	<u>0.24</u>	<u>0.82</u>	<u>5.89</u>
	+ Loss Replacement	<u>51,978</u>	<u>13.75</u>	<u>0.46</u>	<u>3.94</u>	<u>18.14</u>
6) Past Take Up Rates	Net	11,320	-1.93	1.84	4.87	4.78
	+ Flexibility Factor	12,452	-1.68	2.03	5.35	5.70
	+ Loss Replacement	24,724	7.23	2.25	8.47	17.96

Source: Lichfields' analysis
Rounding errors may mean sums do not add.

8.100

Bringing this together, Table 8.34 summarises the employment land requirements for the 5 Core HMA districts. It indicates that over the next 20 years, between 69,672 sqm and 407,321 sqm of office floorspace could be needed across the HMA, although this is distorted by the very high level of net losses in Nottingham City affecting the past take up scenario. If this is excluded, the lower end of the range is raised to 360,911 sqm. Regarding the need for industrial land, this ranges from between 104.79 ha to 180.19 ha.

Table 8.34 Gross Floorspace Requirements for **Core HMA** (including flexibility factor and losses) for 2018 to 2038

Scenario		Offices / R&D (sqm)	Light Industrial (ha)	General Industrial (ha)	Warehousing (ha)	Total Industrial (ha)
1) Experian September 2020 Baseline	Net	<u>187,281</u>	<u>22.23</u>	<u>-19.04</u>	<u>20.72</u>	<u>23.92</u>
	+ Flexibility Factor	<u>198,085</u>	<u>23.18</u>	<u>-17.80</u>	<u>22.28</u>	<u>27.65</u>
	+ Loss Replacement	<u>386,946</u>	<u>59.98</u>	<u>23.71</u>	<u>63.61</u>	<u>147.29</u>
2) Experian March 2020 Baseline	Net	<u>185,836</u>	<u>34.65</u>	<u>-14.12</u>	<u>36.28</u>	<u>56.82</u>
	+ Flexibility Factor	<u>196,638</u>	<u>35.59</u>	<u>-12.89</u>	<u>37.85</u>	<u>60.55</u>
	+ Loss Replacement	<u>385,500</u>	<u>72.39</u>	<u>28.64</u>	<u>79.18</u>	<u>180.19</u>
3) Regeneration Scenario	Net	<u>207,658</u>	<u>25.21</u>	<u>-11.60</u>	<u>41.69</u>	<u>55.30</u>
	+ Flexibility Factor	<u>218,460</u>	<u>26.15</u>	<u>-10.35</u>	<u>43.25</u>	<u>59.03</u>
	+ Loss Replacement	<u>407,321</u>	<u>62.95</u>	<u>31.16</u>	<u>84.59</u>	<u>178.68</u>
4) 2014-based SNPP	Net	161,247	17.66	-22.09	14.53	10.11
	+ Flexibility Factor	172,050	18.61	-20.85	16.08	13.84
	+ Loss Replacement	360,911	55.39	20.68	57.42	133.50
5) Current SM (604 dpa)	Net	215,094	27.96	-18.67	30.73	40.03
	+ Flexibility Factor	225,896	28.90	-17.43	32.28	43.74
	+ Loss Replacement	414,757	65.70	24.09	73.62	163.40
6) Past Take Up Rates	Net	<u>-129,992</u>	<u>-12.83</u>	<u>-3.09</u>	<u>-2.69</u>	<u>-18.59</u>
	+ Flexibility Factor	<u>-119,189</u>	<u>-11.88</u>	<u>-1.85</u>	<u>-1.13</u>	<u>-14.85</u>
	+ Loss Replacement	<u>69,672</u>	<u>24.91</u>	<u>39.67</u>	<u>40.21</u>	<u>104.79</u>

Source: Lichfields' analysis
Rounding errors may mean sums do not add.

Outer HMA

- 8.101 Ashfield District's net employment land needs (incorporating a 2-year flexibility factor) range from 13,165 sqm of office floorspace and 4.68 ha of industrial / warehousing land under the Experian September 2020 Baseline scenario, up to 26,664 sqm of office and 76.87 ha of industrial land for the Past Take-Up scenario.
- 8.102 The gross requirements increase the range to between 23,898 sqm and 37,224 sqm for office floorspace, and to between 46.71 ha and a very substantial 118.90 ha for industrial land to 2038.

Table 8.35 Gross Floorspace Requirements for **Ashfield District** (including flexibility factor and losses) for 2018 to 2038

Scenario		Offices / R&D (sqm)	Light Industrial (ha)	General Industrial (ha)	Warehousing (ha)	Total Industrial (ha)
1) Experian September 2020 Baseline	Net	10,914	2.89	-13.40	8.20	-2.31
	+ Flexibility Factor	13,338	3.48	-12.09	13.29	4.68
	+ Loss Replacement	23,898	15.95	15.80	14.96	46.71
2) Experian March 2020 Baseline	Net	10,741	6.38	-11.62	12.30	7.06
	+ Flexibility Factor	13,165	6.97	-10.31	17.39	14.05
	+ Loss Replacement	23,725	19.44	17.57	19.06	56.08
3) Regeneration Scenario	Net	20,972	3.01	-11.30	13.29	5.00
	+ Flexibility Factor	23,396	3.59	-10.00	18.39	11.98
	+ Loss Replacement	33,956	16.07	17.89	20.06	54.01
4) 2014-based SNPP	Net	13,781	4.92	-12.47	12.09	4.54
	+ Flexibility Factor	16,205	5.51	-11.16	17.18	11.53
	+ Loss Replacement	26,765	17.98	16.73	18.85	53.56
5) Current SM (481 dpa)	Net	15,456	6.11	-11.93	14.36	8.54
	+ Flexibility Factor	17,880	6.70	-10.62	19.46	15.53
	+ Loss Replacement	28,440	19.17	17.27	21.13	57.56
6) Past Take Up Rates	Net	24,240	5.85	13.08	50.96	69.88
	+ Flexibility Factor	26,664	6.43	14.38	56.05	76.87
	+ Loss Replacement	37,224	18.90	42.27	57.72	118.90

Source: Lichfields' analysis
Rounding errors may mean sums do not add.

- 8.103 The need for office and industrial floorspace in the settlement (and immediate surroundings) of Hucknall has also been undertaken, using a combination of applying a proportional split to the econometric forecasts using the Hucknall's current share of Ashfield's resident population / workforce jobs, and combined this with Hucknall-specific data from Officers regarding take up and losses over the past 20 years to 2000/01.
- 8.104 The resultant findings, summarised in Table 8.36, indicates a net requirement ranging from 1,813 sqm – 3,988 sqm for office floorspace net, and between 0.88 ha and 6.07 ha of industrial / warehousing land. The past take-up rates for Hucknall in isolation are low for office floorspace, at just 308 sqm trended forward over 20 years, but much higher for industrial / distribution land, at 13.85 ha.
- 8.105 The gross requirements increase the range to between 828 sqm and 4,508 sqm for office floorspace, and to between 9.74 ha and 22.71 ha for industrial land to 2038.

Table 8.36 Gross Floorspace Requirements for **Hucknall** (including flexibility factor and losses) for 2018 to 2038

Scenario		Offices / R&D (sqm)	Light Industrial (ha)	General Industrial (ha)	Warehousing (ha)	Total Industrial (ha)
1) Experian September 2020 Baseline	Net	1,785	0.47	-2.19	1.34	-0.38
	+ Flexibility Factor	1,813	0.68	-1.72	1.92	0.88
	+ Loss Replacement	2,333	2.91	3.25	3.59	9.74
2) Experian March 2020 Baseline	Net	1,757	1.04	-1.90	2.01	1.16
	+ Flexibility Factor	1,785	1.25	-1.43	2.59	2.41
	+ Loss Replacement	2,305	3.48	3.54	4.26	11.27
3) Regeneration Scenario	Net	3,431	0.49	-1.85	2.17	0.82
	+ Flexibility Factor	3,459	0.70	-1.38	2.75	2.08
	+ Loss Replacement	3,979	2.92	3.59	4.42	10.94
4) 2014-based SNPP	Net	3,493	1.68	-1.64	3.66	3.70
	+ Flexibility Factor	3,521	1.89	-1.17	4.24	4.96
	+ Loss Replacement	4,041	4.12	3.80	5.91	13.82
5) Current SM	Net	3,960	2.01	-1.49	4.29	4.82
	+ Flexibility Factor	3,988	2.23	-1.02	4.87	6.07
	+ Loss Replacement	4,508	4.45	3.95	6.54	14.93
6) Past Take Up Rates	Net	280	2.10	4.71	5.78	12.59
	+ Flexibility Factor	308	2.31	5.18	6.36	13.85
	+ Loss Replacement	828	4.54	10.14	8.03	22.71

Source: Lichfields' analysis
Rounding errors may mean sums do not add.

- 8.106 As set out in Section 5.0, Ashfield District's data on take-up and losses, uniquely amongst the 8 districts, provides a robust level of detail stretching back to 2000/01. Whilst this is helpful as it factors in several economic cycles, Officers raised a concern that this could be distorted due to the presence of the Sherwood Park Enterprise Zone which was very successful in attracting office and to a lesser extent, industrial development to the area in the first few years of the Millennium, to November 2005.
- 8.107 As can be seen in Table 8.37, if the shorter time period of 2011/12-2019/20 is taken as the basis for past take up/losses, then both the gross and net completions rate declines, which has an impact on the overall amount of employment land required. This reduces the gross range of office floorspace from between 23,898 sqm and 37,224 sqm, to between 3,385 sqm and 23,389 sqm. The change in demand for industrial land is less pronounced but would still fall from 46.71 ha-118.90 ha, to 35.03 ha-92.25 ha.

Table 8.37 Gross Floorspace Requirements for **Ashfield** – SENSITIVITY TEST

Scenario		Offices / R&D (sqm)	Light Industrial (ha)	General Industrial (ha)	Warehousing (ha)	Total Industrial (ha)
1) Experian September 2020 Baseline	Net	10,914	2.89	-13.40	8.20	-2.31
	+ Flexibility Factor	11,010	2.41	-14.48	15.25	3.18
	+ Loss Replacement	13,330	11.44	5.73	17.85	35.03
2) Experian March 2020 Baseline	Net	10,741	6.38	-11.62	12.30	7.06
	+ Flexibility Factor	10,838	5.90	-12.70	19.35	12.55
	+ Loss Replacement	13,158	14.94	7.51	21.95	44.40
3) Regeneration Scenario	Net	20,972	3.01	-11.30	13.29	5.00
	+ Flexibility Factor	21,069	2.53	-12.38	20.35	10.49
	+ Loss Replacement	23,389	11.56	7.82	22.95	42.33
4) 2014-based SNPP	Net	13,781	4.92	-12.47	12.09	4.54
	+ Flexibility Factor	13,878	4.44	-13.55	19.14	10.03
	+ Loss Replacement	16,198	13.48	6.66	21.74	41.88
5) Current SM	Net	15,456	6.11	-11.93	14.36	8.54
	+ Flexibility Factor	15,553	5.63	-13.01	21.41	14.03
	+ Loss Replacement	17,873	14.67	7.20	24.01	45.88
6) Past Take Up Rates	Net	968	-4.83	-10.80	70.54	54.91
	+ Flexibility Factor	1,065	-5.31	-11.88	77.60	60.40
	+ Loss Replacement	3,385	3.72	8.32	80.20	92.25

Source: Lichfields' analysis
Rounding errors may mean sums do not add.

- 8.108 Mansfield District's net employment land needs (incorporating a 2-year flexibility factor) range from 8,555 sqm of office floorspace and 5.25 ha of industrial / warehousing land under the 2014-based SNPP labour supply scenario, up to 13,638 sqm office and 11.36 ha of industrial land for the Regeneration scenario. The past take up rates for Mansfield suggest a much lower office need, of -17,865 sqm net, and a higher industrial land requirement of 12.62 ha).
- 8.109 The gross requirements increase the range to between 11,183 sqm and 42,686 sqm for office floorspace, and to between 18.94 ha and 26.31 ha for industrial land to 2038.

Table 8.38 Gross Floorspace Requirements for **Mansfield District** (including flexibility factor and losses) for 2018 to 2038

Scenario		Offices / R&D (sqm)	Light Industrial (ha)	General Industrial (ha)	Warehousing (ha)	Total Industrial (ha)
1) Experian September 2020 Baseline	Net	8,915	10.15	-2.95	0.11	7.30
	+ Flexibility Factor	11,206	10.64	-2.82	0.64	8.45
	+ Loss Replacement	40,254	15.53	-0.56	7.17	22.14
2) Experian March 2020 Baseline	Net	8,343	11.60	-2.16	1.53	10.97
	+ Flexibility Factor	10,634	12.09	-2.03	2.06	12.12
	+ Loss Replacement	39,682	16.98	0.23	8.60	25.80
3) Regeneration Scenario	Net	11,348	10.15	-2.95	3.02	10.21
	+ Flexibility Factor	13,638	10.64	-2.82	3.55	11.36
	+ Loss Replacement	42,686	15.53	-0.56	10.08	25.04
4) 2014-based SNPP	Net	6,264	8.49	-3.58	-0.81	4.11
	+ Flexibility Factor	8,555	8.98	-3.45	-0.28	5.25
	+ Loss Replacement	37,603	13.87	-1.19	6.26	18.94
5) Current SM (275 dpa)	Net	7,216	9.09	-3.35	-0.50	5.23
	+ Flexibility Factor	9,506	9.58	-3.23	0.03	6.38
	+ Loss Replacement	38,554	14.47	-0.97	6.56	20.07
6) Past Take Up Rates	Net	-20,155	4.91	1.28	5.29	11.47
	+ Flexibility Factor	-17,865	5.40	1.41	5.82	12.62
	+ Loss Replacement	11,183	10.29	3.67	12.35	26.31

Source: Lichfields' analysis
Rounding errors may mean sums do not add.

- 8.110 Newark & Sherwood District's net employment land needs (incorporating a 2-year flexibility factor) range from 11,180 sqm of office floorspace and 8.27 ha of industrial / warehousing land under the 2014-based SNPP labour supply scenario, up to 44,959 sqm of office and very substantial 81.78 ha of industrial land based on the Past Take Up scenario.
- 8.111 The gross requirements increase the range to between 46,404 sqm and 80,183 sqm for office floorspace, and to between 26.47 ha and 99.99 ha for industrial land to 2038.

Table 8.39 Gross Floorspace Requirements for **Newark & Sherwood District** (including flexibility factor and losses) for 2018 to 2038

Scenario		Offices / R&D (sqm)	Light Industrial (ha)	General Industrial (ha)	Warehousing (ha)	Total Industrial (ha)
1) Experian September 2020 Baseline	Net	13,806	4.50	-1.39	8.69	11.80
	+ Flexibility Factor	17,893	5.18	2.14	11.92	19.24
	+ Loss Replacement	53,117	7.09	11.33	19.02	37.44
2) Experian March 2020 Baseline	Net	12,573	5.87	-1.31	11.75	16.31
	+ Flexibility Factor	16,660	6.55	2.22	14.98	23.74
	+ Loss Replacement	51,884	8.46	11.41	22.08	41.95
3) Regeneration Scenario	Net	20,209	4.50	-0.74	11.41	15.17
	+ Flexibility Factor	24,296	5.18	2.78	14.64	22.61
	+ Loss Replacement	59,520	7.09	11.98	21.74	40.81
4) 2014-based SNPP	Net	7,093	1.73	-3.13	2.23	0.83
	+ Flexibility Factor	11,180	2.41	0.40	5.46	8.27
	+ Loss Replacement	46,404	4.33	9.59	12.56	26.47
5) Current SM (494 dpa)	Net	10,588	3.17	-2.22	5.59	6.55
	+ Flexibility Factor	14,675	3.86	1.30	8.82	13.98
	+ Loss Replacement	49,899	5.77	10.50	15.92	32.19
6) Past Take Up Rates	Net	40,872	6.82	35.23	32.30	74.35
	+ Flexibility Factor	44,959	7.50	38.76	35.53	81.78
	+ Loss Replacement	80,183	9.41	47.95	42.62	99.99

Source: Lichfields' analysis
Rounding errors may mean sums do not add.

8.112

Bringing this together, Table 8.40 summarises the employment land requirements for the 3 Outer HMA districts. It indicates that over the next 20 years, between 110,919 sqm and 136,309 sqm of office floorspace could be needed across the HMA (gross). Regarding the need for industrial land, this ranges from between 98.93 ha to 244.81 ha (gross).

Table 8.40 Gross Floorspace Requirements for **Outer HMA** (including flexibility factor and losses) for 2018 to 2038

Scenario		Offices / R&D (sqm)	Light Industrial (ha)	General Industrial (ha)	Warehousing (ha)	Total Industrial (ha)
1) Experian September 2020 Baseline	Net	33,635	17.54	-17.74	17.00	16.79
	+ Flexibility Factor	42,437	19.30	-12.77	25.85	32.37
	+ Loss Replacement	117,269	38.57	26.57	41.15	106.29
2) Experian March 2020 Baseline	Net	31,657	23.85	-15.09	25.58	34.34
	+ Flexibility Factor	40,459	25.61	-10.12	34.43	49.91
	+ Loss Replacement	115,291	44.88	29.21	49.74	123.83
3) Regeneration Scenario	Net	52,529	17.66	-14.99	27.72	30.38
	+ Flexibility Factor	61,330	19.41	-10.04	36.58	45.95
	+ Loss Replacement	136,162	38.69	29.31	51.88	119.86
4) 2014-based SNPP	Net	27,138	15.14	-19.18	13.51	9.48
	+ Flexibility Factor	35,940	16.90	-14.21	22.36	25.05
	+ Loss Replacement	110,772	36.18	25.13	37.67	98.97
5) Current SM (481 dpa)	Net	33,260	18.37	-17.50	19.45	20.32
	+ Flexibility Factor	42,061	20.14	-12.55	28.31	35.89
	+ Loss Replacement	116,893	39.41	26.80	43.61	109.82
6) Past Take Up Rates	Net	44,957	17.58	49.59	88.55	155.70
	+ Flexibility Factor	53,758	19.33	54.55	97.40	171.27
	+ Loss Replacement	128,590	38.60	93.89	112.69	245.20

Source: Lichfields' analysis
Rounding errors may mean sums do not add.

9.0 **Demand Supply Balance**

9.1 This section draws together forecasts of future employment land needs in Section 8.0 and estimates of land available within the 8 districts' existing pipeline and allocated employment sites to identify any need for additional provision of employment space, or surpluses of it, in both quantitative and qualitative terms.

9.2 Within the context of identified future requirements, this Section considers which locations and sites appraised in Section 7.0 are capable and suitable for accommodating this growth, based upon a high-level SWOT analysis of the study areas commercial property market and FEMAs. Factoring in feedback from the property market consultation and Business Survey, the Section concludes with recommendations for how the anticipated growth of the economy over the 2018-2038 period could be distributed spatially within the two FEMAs, by sector, providing an indication of gaps in current land supply for each market segment.

Needs of Different Employment Uses

9.3 Six scenarios have been analysed in Section 8.0 to indicate the broad scale and type of employment growth arising from different approaches to modelling employment land needs for the Core and Outer HMAs. The scenarios reflect both indigenous needs arising within individual authorities; additional economic potential associated with the D2N2 LEP's growth sectors; and the growth of future labour supply. Whilst growth needs have been identified on an HMA and individual local authority basis, there will be some degree of footloose needs that potentially operate and can be accommodated across individual local authority boundaries.

9.4 Where B8 distribution is referred to in Section 8.0, it should be noted that this primarily relates to localised, or indigenous, needs. Strategic logistics needs of national and regional distribution centres are generally not reflected in either the past take-up or econometric modelling data (with the partial exception of Ashfield District's past take up data). Strategic B8 needs are discussed later in this section.

9.5 To ensure a flexible and responsive policy framework, it will be necessary not just to focus on meeting forecast quantitative requirements (which will fluctuate over time), but to consider the opportunities and risks that flow from particular policies or types of land allocations. This might concern how delivery can be prioritised in some locations or for some types of employment uses, or how scope can be created for meeting (as yet) undefined inward investment opportunities, e-commerce and specifically strategic B8 needs.

Core HMA

9.6 In summary, the range of indicative total floorspace/land requirements over the period 2018-3038, factoring in a 2-year flexibility factor, is as follows for the five Core HMA districts:

Table 9.1 Floorspace/Land Requirements for Core HMA

		Adopted Local Plan Requirement – Offices 2011-2028	Need for Offices 2018-38 (sqm)		Adopted Local Plan Requirement – Industrial / B8 2011-28	Need for Industrial / Distribution 2018-38 (ha)	
			Experian/Labour Supply Range	Past Take Up Scenario		Experian / Labour Supply Range	Past Take Up Scenario
Broxtowe	Net	34,000 sqm	9,642-19,081	14,973	15 ha	7.87-19.82	14.27
	Gross	(40,000 sqm*)	28,006-37,445	33,337	(17.65 ha*)	26.61-38.56	33.00
Erewash	Net	42,900 sqm	3,876 - 16,065	-2,928	10 ha	-13.17 – 1.87	2.00
	Gross	(50,470 sqm*)	14,587 – 26,776	7,783	(11.76 ha*)	24.99 - 40.03	40.16
Gedling	Net	23,000 sqm	7,933 - 12,345	23,069	10 ha	12.45 – 22.26	0.48
	Gross	(27,060 sqm*)	11,789 - 16,201	26,925	(11.76 ha*)	21.98 – 31.80	10.01
Nottingham	Net	253,000 sqm	118,662 – 157,462	-166,755	25 ha	-2.12 - 18.23	-37.30
	Gross	(297,650 sqm*)	262,320 – 301,120	-23,097	(29.41 ha*)	38.85 - 59.19	3.66
Rushcliffe	Net	67,900 sqm	28,800 - 39,706	12,452	20 ha	1.83 - 10.21	5.70
	Gross	(79,880 sqm*)	41,072 - 51,978	24,724	(23.53 ha*)	14.09 - 22.46	17.96
Core HMA Total	Net	420,800 sqm	168,913 – 244,659	-119,189	80 ha	6.86 – 72.39	-14.85
	Gross	(495,060 sqm*)	357,774 – 433,520	69,672	(94.11 ha*)	126.52 – 192.04	104.79

Source: Lichfields' analysis

* Note: extrapolated to 20 years for comparative purposes and rounded

9.7 There is reasonable alignment between the Experian / labour supply scenarios and the adopted Local Plan requirements, once an adjustment has been made to reflect the different time periods. In terms of office floorspace requirements (and comparing the like-for-like gross requirements with the planning requirements), in general the Broxtowe range is in line with the current Plan requirements, as is the Nottingham City figure, whilst the Plan requirements for Erewash, Gedling and Rushcliffe are higher than the latest modelling suggests would be needed. For Nottingham City the figures coalesce at between 260-300,000 sqm which reflects the City's important role as a focus for service sector growth in the sub-region. The past take-up scenario for offices appears to be an outlier for many of the districts, but particularly for Nottingham City and Broxtowe.

9.8 As for industrial / distribution needs, the modelling generally indicates a need for more land than is currently in the adopted local plans once a suitable allowance has been made for loss replacement. This is particularly the case for Erewash and Nottingham City. In contrast with office floorspace, the past take-up levels for industrial uses appear a closer fit with the adopted local plan requirements, with a gross need for 105 ha compared to 80 ha in the plans (once the figure has been extrapolated up to 20 years).

9.9 As with the previous ELFS, given the general constraints on land supply within Nottingham City, it seems probable that the additional industrial land requirements identified would need to be accommodated in the surrounding authorities of Erewash, Broxtowe, Gedling and Rushcliffe in locations with good access to strategic routes and according with the other principles noted below:

- good accessibility to the transport network and labour market;
- sites that are attractive to the market;

- the availability of sites for employment use; and
- Green Belt designations, in particular those to maintain openness and prevent coalescence between Nottingham, Derby and other surrounding settlements.

Outer HMA

- 9.10 In summary, the range of indicative total floorspace/land requirements over the period 2018-3038, factoring in a 2-year flexibility factor, is as follows for the three Outer HMA districts:

Table 9.2 Floorspace/Land Requirements for Outer HMA

		Adopted Local Plan Requirement (ha)	Need for Offices 2018-38 (sqm)		Need for Industrial / Distribution 2018-38 (ha)	
			Experian/Labour Supply Range	Past Take Up Scenario	Experian / Labour Supply Range	Past Take Up Scenario
Ashfield	Net	194.3 ha (1991-to 2011)	13,165 - 23,396	26,664	4.68 – 15.53	76.87
	Gross		23,898 - 33,956	37,224	46.71 – 57.56	118.90
Mansfield	Net	41 ha (2013-33)	8,555 – 13,638	-17,865	5.25 – 12.12	12.62
	Gross		37,603 -42,686	11,183	18.94 – 25.80	26.31
Newark & Sherwood	Net	83.1 ha (2013-33)	11,180 – 24,296	44,959	8.27 - 23.74	81.78
	Gross		46,404 – 59,520	80,183	26.47 – 41.95	99.99
Outer HMA	Net	318.4 ha	32,900 – 61,330	53,758	18.2 – 51.39	171.27
	Gross		107,905 – 136,162	128,590	92.12 – 125.31	245.2

Source: Lichfields' analysis

- 9.11 The comparison with the most recent adopted Local Plan is less straightforward for Ashfield, given that the Plan is out of date, with an employment land figure that relates to 1991-2011. Furthermore, the three districts do not provide a separate office floorspace breakdown and instead provide an overall employment land figure that incorporates office, industrial and warehousing land.
- 9.12 Taking all these points into account, for Ashfield, the outdated Local Plan requirement looks significantly in excess of the scale of employment land that would now be suggested, based on the latest modelling. This is despite the clear divergence between the econometric/labour supply modelling and the past take up rates of industrial land in particular.
- 9.13 For Mansfield, the more up to date Local Plan requirement of 41 ha is slightly above the upper end of the Experian / labour supply range (assuming a plot ratio of 40%, this would equate to 10.67 ha of office land in addition to 25.04 ha of industrial land, or 35.7 ha in total).
- 9.14 For Newark & Sherwood, the divergence from the adopted Local Plan is more pronounced, with the econometric/labour supply modelling suggesting a need for less land than is currently being provided for in the Local Plan, whilst the continuation of past trends suggests a figure well in excess of the 83.1 ha currently being planned for (even if losses are entirely excluded from the calculation).

- 9.15 The selection of the final employment land requirement will depend upon the preferred level of employment growth for each district and the extent to which Officers consider that this aligns with that Council’s growth aspirations, including the need to align with housing targets and taking account of the D2N2 LEP SEP’s growth sectors. The level of employment growth will be based upon the identification of policy aspirations relating to the promotion of key sectors in accordance with the economic and spatial vision for the area.

The need for Strategic B8 Distribution

- 9.16 As set out in Section 5.0, Logistics is a fast-moving sector and one that has seen an unprecedented level of change and growth over the past 12 months or so. In recent years, it has changed beyond all recognition and been a key driver of commercial property markets – maintaining significant levels of demand and activity. However, the Covid-19 pandemic has greatly accelerated these trends, and according to one logistics operator, the past 9 months have accelerated trends that would otherwise have taken five years or more to occur.
- 9.17 The issue facing this study however, is that as a relatively recent phenomenon, the needs of strategic (large scale) B8 Distribution uses are not easily revealed via the methodology recommended for forecasting employment land needs by the Government in the PPG. The approach does not distinguish between small scale and large scale B8 other than through the use of different employment land densities, but any approach that essentially relies on past trends for forecasting future needs is, by its very definition, going to struggle to accurately project new or emerging trends in the market.
- 9.18 This is an issue for the 8 Nottingham Core/Outer HMA authorities, as with one or two notable exceptions, there has been a lack of strategic ‘big box’ B8 allocations that have come forward in recent years in the sub-region. **As referenced in Section 5, commercial agents and logistics developers/operators have criticised the lack of large ‘big box’ B8 allocations that have come forward in recent years across the Greater Nottingham sub-region.** According to agents, the availability of Grade A supply in the study area is at a record low, with vacancy rates very low throughout the sub-region and typically short void periods. Taking as a broad rule of thumb a minimum floor area of 200,000-500,000 sq ft (18,580 – 46,450 sqm) for most Regional Distribution Centres (although Amazon often develop larger units for this purpose – see examples below) and between 500,000 sq ft – 1 million sq ft and above (46,450 sqm – 92,900 sqm+) on up to 100 acres for National Distribution Centres⁹⁹, there have only been a limited handful of sites coming forward across all 8 districts in recent years.

- 9.19 These include:

Broxtowe Borough:

- **Amazon Development at Nottingham 26, Eastwood.** This site was brought forward by First Panattoni in 2018 (18/00090/REM – Reserved matters application - Reserved matters approval for the erection of one

⁹⁹ BPF (2019): *What Warehousing Where?*

industrial / warehouse unit (Use Class B1c, B2 and B8) with ancillary offices, plant, gatehouse, associated infrastructure including service yards, access, parking, landscaping and associated development – Granted 12.04.18) and involved the development of the site to accommodate a single industrial/distribution unit (use class B1c, B2 and B8) with associated service yards, parking, landscape and associated office facilities. The key elements of the application were as follows¹⁰⁰:

- (i) A 550,300ft² / 51,126 sqm warehouse unit with a haunch height of 15m;
- (ii) An office element of the unit including 9,000ft² / 836 sqm of hub offices and 20,000ft² / 1,858 sqm of office suites;
- (iii) A 25 sqm / 270ft² gatehouse;
- (iv) Space for 425 car parking space and 22 disabled parking spaces

The site was built out in 2019/20 and the warehousing element is now occupied by Amazon.

Ashfield District:

- **Summit Park**, Sutton in Ashfield (Ashfield District): South West Oakham employment allocation distribution warehouse was developed for a **162,791 sqm** B8 Amazon warehouse in 2019/20;
- **Also at Summit Park** in Ashfield District, planning permission has been granted for Office (1,300 sqm), Light Industrial (6,700 sqm) and General B2 Industrial (1,550 sqm), which totals 9,550 sqm – although this would not be considered a ‘big box’ logistics site;
- **Castlewood Business Park 2015/16** (planning application ref v/2015/0031) – warehouse with ancillary office facilities: B8 7,781 sqm; Office 1,545 sqm (totalling 9,226 sqm) over 2.11 ha.
- **Also at Castlewood Business Park 2018/19** (planning application ref v/2018/0217) – warehouse/industrial with ancillary office facilities: B2 11,080 sqm; B8 11,080 sqm; Office 1,020 sqm (totalling 23,180 sqm) over 5.31 ha.
- **Also at Castlewood Business Park 2018/19, but not yet developed at the time of writing** (planning application ref v/2018/0652) – warehouse 19,235 sqm over 5.0 ha.
- **Harrier Park, (Rolls Royce)** in Hucknall has been constructed over the last few months of 2020 comprising GIA Office 2,903 sqm, B2/B8 15,291 sqm, totalling **18,194 sqm**.

Newark & Sherwood District:

- **Dixons Mastercare site** – developed in 2006/07, this 19.05 ha development comprised warehousing and ancillary offices at South Airfield Farm.

¹⁰⁰ Stephen George + Partners LLP (January 2018): *Nottingham 26 Eastwood – Design Statement*

- 9.20 Therefore, for the other districts (Erewash, Gedling, Nottingham City, Rushcliffe, Mansfield and to an extent Newark & Sherwood, given that the Dixons site was built out 14 years ago and is not reflected in the medium term take up rates), large scale logistics is not reflected in the take up data, and given the recency of the shift towards e-commerce, it is arguably not reflected in the Experian modelling either.
- 9.21 This may explain the large discrepancy in B8 land requirements for Ashfield District in Table 8.35, which identifies a net requirement for 56 ha of B8 land based on past take up rates trended forward, compared to between 13 and 18 ha based on the econometric/labour supply scenarios. This could suggest that an element of strategic B8 is reflected in Ashfield's past take up scenario, and not the other five which are more likely to focus on the specific indigenous small scale B8 needs of Ashfield District. For example, the September 2020 Experian model run suggests that there will be a net growth of only around 423 B8 jobs between 2018 and 2038, compared to 1,679 jobs over the same time period if the past job growth rates [CAGR] are trended forward.
- 9.22 Elsewhere, B8 requirements are as follows:
- Broxtowe Borough: between 7.68 ha and 15.59 ha;
 - Erewash Borough: between 9.50 ha and 18.73 ha;
 - Gedling Borough: between 2.76 ha and 14.20 ha;
 - Nottingham City: between 1.44 ha and 38.28 ha;
 - Rushcliffe Borough: between 2.23 ha and 8.47 ha;
 - Ashfield District: between 14.96 ha and 57.72 ha;
 - Mansfield District: between 6.26 ha and 12.35 ha; and,
 - Newark and Sherwood District: between 12.56 ha and 42.62 ha.
- 9.23 Therefore, for the whole of the Core HMA, the total B8 requirement ranges from 23.61 ha and 95.27 ha, whilst for the three Outer HMA districts the B8 requirement ranges from 33.78 ha to 112.69 ha.
- 9.24 Certainly, for the Core HMA at least, the B8 net requirements appear insufficient to meet likely needs and are likely to relate to localised distribution requirements only.

Case Study: The East Midlands Gateway

Repeated reference was made to the success of the East Midlands Gateway, a Strategic Rail Freight Interchange [SRFI] encompassing an area of approximately 336 ha immediately to the west of the M1 between Junctions 24 and 24A in North West Leicestershire¹⁰¹, immediately to the south/south-west of the study area. The masterplan for the SRFI site includes provision for up to 547,414 sqm of warehousing and service buildings served by an intermodal freight terminal accommodating up to 16 trains per day¹⁰².

¹⁰¹ The East Midlands Gateway Rail Freight Interchange Examining Authority's Report of Findings and Conclusions and Recommendation to the Secretary of State for Transport (12th October 2015)

¹⁰² https://www.nwleics.gov.uk/pages/east_midlands_gateway

The site is also located immediately to the north of the East Midlands Airport, the UK's busiest cargo airport, so it benefits from a degree of multi-modal connectivity that is not available anywhere in the Nottingham Core/Outer HMA, hence direct comparisons must be treated with considerable care. Nevertheless, since the DCO was approved in 2015 and construction commenced, 7 very large B8 distribution units have been constructed ranging from 16,500 sqm (177,500 sq ft) to 64,500 sqm (694,000 sq ft). Totalling 275,500 sqm (2,965,500 sq ft), all seven constructed units have either been let or sold as of October 2020, with plots available to accommodate a further 278,700 sqm (3,000,000 sq ft) with fast track delivery¹⁰³.

The promotional material boasts that units can be delivered within 32 weeks following signing of commercial terms, with space for units from 100,000 sq ft to 3,000,000 sq ft and flexible eaves heights up to 30m.

Clearly the site's proximity to Nottingham means that some of the strategic B8 demand is likely to be directed to the East Midlands Gateway, although its location almost equidistant from Nottingham, Derby and Loughborough (and even Leicester further south) means that it will pick up a substantial amount of B8 demand from these locations too.

Nevertheless, the East Midlands Gateway remains an excellent example of the strength of demand for large scale logistics in this part of the region and demonstrates the extent to which the so called 'Golden Triangle' is being extended northwards.

- 9.25 As set out in Section 5.0, stakeholders were of the opinion that employment growth across Greater Nottingham has been limited by lack of available sites over the past decade and that studies forecasting need based purely on past trends, will significantly underestimate the scale of demand. **Agents were confident that there is capacity in the market for one, or even two, large regional distribution centres at these key M1 junctions and that at current levels of demand, two such schemes would be at capacity within a decade.**
- 9.26 The EMG site is 336 ha in size including a SRFI and we are not suggesting that anything like this scale of site should, or even could, be accommodated in the Nottingham Core/Outer HMA given the unique multi-modal benefits the EMG possesses. Nevertheless, with demand for units of anywhere from 500,000 sq. ft (46,450 sqm) up to 2 million sq. ft (185,800 sqm) increasing, stakeholders agreed that the market is far from saturation and the current levels of demand are likely to persist.
- 9.27 **In terms of the size of site that could be planned for, logistics developers we consulted, suggested that ideal sites for distribution are seen to be in the range of 50 – 60 hectares, with planning for around a million sq. ft (c.93,000 sqm) that can be distributed towards 5/6 smaller units or (with a higher degree of risk) into 1 or 2 large ones.** Two of the larger distribution sites that have come forward in recent years, namely the Dixons Mastercare and the Amazon Distribution

¹⁰³ Segro Logistics Park (October 2020): *East Midlands Gateway Brochure*

Centre at Summit Park, were around 19-20 ha in size, that each accommodate one very large distribution unit. A site in the order of around 50-60 ha could therefore accommodate 2-3 very large distribution units along the lines of those seen at Summit Park or Dixons Mastercare.

9.28

In terms of where this unmet strategic distribution should be needed in the Nottingham Core/Outer HMA, the following broad locational criterion for Regional /National Distribution Centres should be taken into account:

- Immediate **proximity to a junction on the Strategic Road Network**, preferably a Motorway along the central spine of the country;
- For larger National Distribution Centres, proximity to a **Strategic Rail Freight Interchange / Ports and/or Airports** can be an important consideration;
- **Avoiding areas of saturation of supply**, in terms of existing competing facilities, but also of labour force, to avoid situations where unemployment rates are very low and labour likely to be too expensive/difficult to employ;
- Access to **last mile fulfilment hubs** nearby;
- **Areas earmarked for future housing growth**. This will provide both a growing market for e-commerce and also the increased labour force to service it;
- Superfast **broadband** connectivity;
- **Limited congestion** on the local road network and capacity to expand operations without onerous conditions on vehicle movements;
- Readily **accessible, and suitably skilled, labour supply** – generally there is a c. 30 minutes maximum drive time that workers are willing to make to these types of facilities;
- **Close proximity to a major urban area**, to ensure that occupiers can access graduates from Higher Education facilities and ensure there is a large labour supply with a broad mix of skills. Proximity to these urban areas is also vital to link in with last mile depots and enable next day delivery for e-commerce;
- Preference from developers to **expand existing sites with capacity** rather than risk disruption to road networks by grouping smaller sites close to one another;
- **Scope for unfettered 24 hr / 365-day operations**;
- Flexibility on **car parking** arrangements;
- **Large flat plots** with potential for open storage and yards;
- Wider sustainability opportunities and support through **infrastructure provision** (EV charging points, e-cargo bikes etc.). This means that there must be sufficient energy generation capacity in the vicinity of the site, which is increasingly important for depots with numerous charging points for electric delivery vehicles.

9.29

Setting to one side the points regarding access to ports, airports and SFRI, it is not surprising that all the agents interviewed were very clear that they

considered the junctions on the M1 Corridor through the study area as being the ideal locations for accommodating this unmet need for strategic large-scale distribution. On the eastern side of Nottingham, demand is significantly weaker, and although it is reasonable at present due to the widespread shortage of sites, concerns were expressed by agents that these eastern areas would be the first ones to struggle in the next economic downturn. This was partly due to the comparatively poor east-west road linkages, and also the increasingly sparse population centres the further one moves eastwards away from the conurbation. This dampens demand for strategic B8 along the A1 (despite the high quality and historically strategic importance of this road).

9.30 The M1 junctions that are in/close proximity to the study area are: Junction 25 at Sandiacre (Erewash Borough); Junction 26 at Nuthall (Broxtowe); Junction 27 beside Sherwood Business Park (Ashfield District) and Junction 28 at Castlewood (Bolsover District, but close beside Ashfield District's Common Road Industrial Estate).

9.31 The scope of work did not involve a comparative assessment of the merits of these junctions, and several are located in the Green Belt with significant policy restrictions.

9.32 **Given the scale and urgency of this issue, the District Councils (potentially working with adjoining districts along the M1 Corridor) may wish to consider commissioning a further strategic study to quantify the scale of strategic B8 logistics need across the Core/Outer HMA and beyond that builds on the indicative suggestions set out above. This future study should seek to quantify the scale of strategic B8 requirements and potentially identify sites where this need should be allocated. Our view would be that the main focus of this future study should be along the M1 Corridor and A-roads near to the Motorway junctions.**

Quantitative Balance

9.33 This section compares actual levels of available land with anticipated requirements to understand the extent to which new allocations may be required.

9.34 In terms of how the employment land requirements relate to the current employment land portfolio, various factors make any such quantitative analysis an inexact science. On the supply side of the equation the total amount of land available at any given point in time is indeterminate. The exact amount depends upon:

- 1 The size of private reserves (i.e. industrial land held with existing buildings for expansion). These are normally excluded from the analysis as they are not generally available for development.
- 2 The number of windfall sites arising which are not presently allocated for employment uses, but which may become available for such uses.
- 3 The number of further sites becoming available through the recycling of land currently in industrial use.

- 9.35 Bearing these points in mind, and as set out in Section 7.0, the detailed site assessments provide a snapshot of the current available employment land on strategic sites across the two HMAs. This comprises:
- 1 Sites allocated for employment development in the current adopted local plan that remain partially or fully undeveloped (designated new employment sites);
 - 2 Existing employment sites designated as Protected Employment Areas that may have vacant land within their boundaries; and,
 - 3 Other sites with extant planning permission for employment uses.

Core HMA

Broxtowe Borough

- 9.36 Broxtowe Borough Council's Local Plan Part 1 (Aligned Core Strategy) was adopted in 2014 and provided a range of suitable sites for new employment, with a minimum of 34,000 sqm allocated for office development and 15 ha for industrial and warehouse uses.
- 9.37 Employment data provided by Broxtowe Borough Council Officers, and dated 31st March 2020, indicates that Broxtowe's supply information is as follows:
- 7,945 sqm of unimplemented permissions, on sites totalling 4.04 ha, of which 3,851 sqm are B1, 3,790 sqm B2 and 304 sqm B8.
 - 18,000 sqm of unimplemented allocations in the form of mixed B Classes as part of a mixed use allocation in Policy 3.2 of the Part 2 Local Plan (Land in the vicinity of the HS2 station at Toton – Strategic location for growth).
- 9.38 The Council has not split the Mixed B-Class data down into office, industrial or distribution. Applying a standard plot ratio of 40% to the 18,000 sqm would suggest that the Council has a total of **8.54 ha of committed employment land remaining** as of 31st March 2020.
- 9.39 Paragraph 2.8 of the Local Plan Part 2 states that: *“The Core Strategy requirements for industrial, warehouse and office/research development will be met by a combination of sources: existing employment commitments, as shown on the Policies Map, at Mushroom Farm, Eastwood, Aero Fabrications, Eastwood and Beeston Business Park; employment development as part of mixed-use development at Chetwynd Barracks (policy 3.1), the Toton Strategic Location for Growth (policy 3.2) and Boots, Beeston (Core Strategy policy 4); and conversions of under-used town and district centre uses (as encouraged by policy 10). Site allocations specifically for employment uses are therefore not required.”*

Table 9.3 Demand/Supply Balance of Employment Space 2018-2038 for Broxtowe Borough

		Office / Industrial / Warehousing Land Supply as of 31 st March 2020	Need for Offices 2018-38 (sqm)		Need for Industrial / Distribution 2018-38 (ha)	
			Experian/Labour Supply Range	Past Take Up Scenario	Experian / Labour Supply Range	Past Take Up Scenario
Broxtowe	Net	8.54 ha	9,642-19,081	14,973	7.87-19.82	14.27
	Gross		28,006-37,445	33,337	26.61-38.56	33.00

Source: Lichfields' analysis / BBC

- 9.40 A broad comparison of estimated demand for employment space against all currently identified supply, as shown in Table 9.3, implies that depending on the scale of loss replacement targeted by the Council, there would not be sufficient office / industrial floorspace in quantitative terms to accommodate even the lowest baseline labour supply scenarios. The higher Experian/Regeneration scenarios would require significantly more office and industrial floorspace. There is a much more substantial difference between the current level of supply and the past take up scenario, with the latter being almost 5-times higher (translating office floorspace to land via 40% plot ratio), although this is somewhat distorted by the high level of floorspace delivery experienced in 2019/20.
- 9.41 The 8.54 ha supply appears insufficient to meet the identified needs, particularly given the Borough's excellent connectivity on the strategic road network, suggesting further sites may need to be allocated (dependant on the scale of loss replacement that the Council decide to allow for).
- 9.42 Of the 18 strategic employment sites Lichfields appraised as part of this study, only three had any available land that could come forward for employment use. (*note: the land in the vicinity of the HS2 station at Toton (Strategic Location for Growth) was not one that Lichfields was asked to review as part of this study*).
- 9.43 The three appraisal sites with available land related to 2.52 ha at Boots Campus (BBC16), 1.51 ha at Nottingham 26 (BBC17) and 0.44 ha at Aero Fabrications (BBC18). All three sites were rated as being 'good' from an employment land perspective.
- 9.44 The two sites are included as 'employment commitments' within the Part 2 Local Plan, although none are assigned a specific hectareage as set out in the excerpt from paragraph 2.8 of the Plan (above). Nottingham 26 has been constructed at the site of 'Mushroom Farm, Eastwood', and after the very large distribution depot now constructed (and occupied by Amazon), around 1.51 ha remains. As for Aero Fabrications, although this has been partly built out recently, the second phase has not yet begun construction (estimated at around 0.44 ha). Added to the 2.52 ha at the Boots Campus, it is considered that around **4.47 ha remains to be added to the overall supply**.
- 9.45 Of the other sites referenced in paragraph 2.8 of the LPP2 as existing commitments, the Beeston Business Park site has recently been fully built out for employment uses. The Toton Strategic location is already included in Table 9.3 as a commitment, whilst no figure has been provided for the Chetwynd

Barracks mixed use site (and Lichfields was not asked to appraise this site). Officers confirmed that it would not be appropriate at this stage to include anything substantial in the supply for Chetwynd Barracks – the Part 2 Local Plan (Policy 3.1.6c) refers only to ‘small scale’ employment development at this location, and it is understood that details are under discussion with the Neighbourhood Forum, the County Council and the emerging Development Corporation. Proposals for this site will not be finalised until later in 2021, potentially via an SPD.

- 9.46 Once the additional 4.47 ha is added to the overall supply, bringing it up to **13.01 ha**, there is still a shortfall in supply against all of the scenarios, indicating that further sites may need to be identified by the Council.

Erewash Borough

- 9.47 Erewash Borough Council adopted its Core Strategy in March 2014. Policy 4 (Employment Provision and Economic Development) outlines that the economy of Erewash will be strengthened and diversified with new floorspace being provided across all employment sectors. The current policy allocates a minimum of 42,900 sqm of office floorspace and 10 ha of land for industrial and warehousing uses relating to the Stanton Regeneration site. A significant proportion of the Stanton Local Plan allocation was sold to new owners in December 2020 and amounts to c. 85 hectares of formerly redundant employment space being brought back into a mix of uses. The remainder of the site continues to be earmarked for residential and complementary land-uses.
- 9.48 According to Council Officers, the current employment land supply in Erewash therefore consists of those sites with extant planning permission for industrial/commercial employment uses, and the aforementioned single allocated site at Stanton. This very substantial regeneration site is anticipated to accommodate approximately 10 ha of B1b, B1c, B2 and B8 provision, with a further 42,900 sqm of B1a office floorspace based on the current allocation. However, given the recent acquisition of a significant proportion (c.85 hectares) of the Stanton Local Plan allocation site which is anticipated to be brought forward for employment uses, there is the potential for a significant future uplift in available employment space in the Borough.
- 9.49 Regarding the extant planning permissions, Table 9.4 indicates that there are currently 2,291 sqm (net) of office floorspace that currently has extant planning permission in the Borough, plus 1,334 sqm of B2 general industrial and 16,595 sqm of B8 warehousing. There are also extant planning permissions on existing employment land that would result in the net loss of 1,644 sqm of light industrial floorspace. This totals 18,577 sqm and is all in addition to the aforementioned Stanton Regeneration site.

Table 9.4 Extant employment land supply in Erewash Borough

			Office	R&D	Light Industrial	B2	B8	Mixed B Class
Extant planning permissions as of 31 st March 2018	Not started		3,834	790	1,817.5	-1,246	661	68
	Started		4,047	0	196	2,296	11,447	0
	unsure		0	0	0	331	0	0
	TOTAL		7,881	790	2,013.5	1,381	12,108	68
Extant planning permissions as of 31 st March 2020	2019/20	not started	90	0	-629	-10,535	11,420	0
		started	0	0	0	0	0	0
		unsure	0	0	0	-70	3,360	0
	2018/19	not started	1,262.3	0	-1,015	11,939.3	1,815	0
	2016/17	started	939	0	0	0	0	0
	TOTAL		2,291.3	0	-1,644	1,334.3	16,595	0
Undeveloped Allocations (Stanton Regeneration Site)			42,900	-	-	10 hectares		

Source: EBC 2021 / Lichfields analysis

9.50 In terms of benchmarking this supply to compare with the employment land need identified in Section 8.0, in 2018 there was a total of 24,242 sqm of employment floorspace with extant planning permissions (compared to 18,577 sqm by 31st March 2020). All of the Stanton Regeneration site was available as the anticipated regeneration of the entire site had yet to commence by that point.

Table 9.5 Demand/Supply Balance of Employment Space 2018-2038 for Erewash Borough

		Office Supply as of 31 st March 2018	Need for Offices 2018-38 (sqm)		Industrial / B8 Supply as of 31 st March 2018	Need for Industrial / Distribution 2018-38 (ha)	
			Experian/Labour Supply Range	Past Take Up Scenario		Experian / Labour Supply Range	Past Take Up Scenario
Erewash	Net	51,571 sqm	3,876 - 16,065	-2,928	13.89 ha	-13.17 - 1.87	2.00
	Gross		14,587 - 26,776	7,783		24.99 - 40.03	40.16

Source: Lichfields' analysis / EBC

9.51 A comparison of estimated demand for employment space against all currently identified supply, as shown in Table 9.5, implies that depending on the scale of loss replacement targeted by the Council, there would be more than sufficient office floorspace in quantitative terms to accommodate all of the scenarios, including past take up. This is in contrast with the provision of industrial land, which appears insufficient even to meet the lowest (labour supply 2014-based SNPP) scenario, of 24.99 ha. At the upper end of the range, both the Regeneration and Past Take-up Scenarios suggest that there could be a shortfall in the order of around 26 ha.

9.52 Of the 16 strategic employment sites Lichfields appraised as part of this study, only two had any available land that could come forward for employment use:

- EBC 8 Quarry Hill Industrial Estate was rated as being Good/Very Good for employment use. There is a small, overgrown patch of land to the west of the site that could potentially come forward for employment use, totalling 0.15 ha. It is not currently allocated for employment uses.

- EBC 13 Digby Street Industrial Estate has two small plots of land that would be available for redevelopment for employment use. These total around 0.49 ha, and Lichfields recommended that the wider site should be protected for employment use and the remaining plots allocated for such uses.

9.53 The inclusion of these two small plots of land would increase the supply only marginally, from 13.89 ha of industrial/warehousing land, to **14.53 ha**, still well below the level of land needed.

9.54 In contrast, the Stanton Regeneration site may have a significant role to play in addressing this shortfall. It is understood that a significant proportion of the Stanton local plan allocation site was sold to new owners in December 2020 and amounts to c. 85 hectares of formerly redundant employment space being brought back into a mix of uses. As shown in the Stanton Regeneration Site SPD, this new employment space would incorporate the existing Local Plan requirements of 10 ha/42,900 sqm. Whilst details of the exact intentions of the owners are not confirmed at present, it is likely that the site will be brought forward for employment uses in accordance with the SPD. This would amount to c. 85 hectares employment land, thereby resulting in a potential significant future uplift in available employment space in the Borough.

9.55 Lichfields reviewed part of the Stanton Regeneration Site as part of this study (EBC6) and rated this as being of Average / Poor quality given the potential constraints on the site. However, following the recent acquisition by Verdant Regeneration Ltd. of c. 85 hectares of the Stanton allocation (including the area of land reviewed by Lichfields), it is likely that the site will come forward for employment uses. Nevertheless, Officers consider that this development has the ability to radically alter the quantum and quality of available industrial (light and general) land in the Borough that would even be in excess of the calculated projections. This would be a scale of development that has not been seen in the Borough for many years, and certainly not in the monitoring period from which we have drawn our development trends.

9.56 Given its scale, location and accessibility, Stanton could potentially have a key role to play in meeting wider employment needs over and above Erewash's own requirements, which would be a policy choice for Erewash to take and one to be agreed with other districts in the Core HMA under the Duty to Co-operate.

Gedling Borough

9.57 The Gedling Local Plan Part 1 (Aligned Core Strategy) was adopted in 2014 and sets out the strategic policy direction for future development in Gedling Borough. Policy 4 (Employment Provision and Economic Development) sets out how the economy of the area will be strengthened and diversified with new floorspace being provided across all employment sectors; with a minimum of 23,000 sqm allocated for office development and 10 ha for industrial and warehouse uses for the plan period 2011-2028.

9.58 In this context, the employment land supply position at 31st March 2018 for Gedling Borough is set out in Table 9.6. This includes allocations and commitments. The site areas have been recalculated by the Council from the original figures contained within the adopted Local Plan to align with more

detailed site information sent based on more accurate planning permissions / applications. This indicates that in 2018, **19.35 ha** of committed employment land was available in the Borough across 5 sites.

Table 9.6 Extant employment land supply in Gedling Borough as of March 31st 2018

Site	Total Employment Land Available	Commentary
Teal Close	8.6	Allocated site for 7 ha under the Greater Nottingham Aligned Core Strategy ACS Policy 2. Outline planning permission (2013/0546) for Mixed B1-B8 employment uses (up to 18,000 square metres) granted in June 2014. Reserved matters application (2017/0800) was granted in October 2017 and included a phasing schedule for B1-B8 use. Reserved matters application (2019/0614) was granted permission in relation to part of the employment area in November 2019. 2019/0615 approval of reserved matters in relation to appearance, landscaping, layout and scale for the development of the employment area (6no. employment units) pursuant to outline planning permission 2017/0999. Pending consideration.
Top Wighay Farm	6.5	Allocated site under the ACS Policy 2. 2020/0050 - Outline planning application for mixed-use development comprising; 805 homes, land for employment purposes (up to 49,500m2 of B1/B8 uses), a Local Centre comprising A1-A5, B1(a) and D1 uses (up to 2,800m2), a 1.5 FE Primary School and associated infrastructure, open space. Decision pending. The revised Development Brief SPD for this site was adopted in February 2017. An EIA application (2019/0875EIA) was granted that made reference to anticipated 6.6 hectares of B1 and B8 uses on the site.
Gedling Colliery/Chase Farm	2.45	5 ha site allocated in the ACS for employment-led mixed-use development reflecting opportunities to incorporate visitor-related facilities associated with Gedling Country Park under LPD Policy E1. Outline planning permission granted (July 2020, reference 2017/1571) for the erection of employment units (Class B1c/B2/B8 Use), Pub/Restaurant (Class A3/A4 Use) and Drive Thru (Class A3 Use), together with associated parking, servicing and landscaping. The Design and Access Statement accompanying the application (2017/1571) indicates that the gross site area is 4.12 ha, with 2.45 ha equating to the net developable area for employment development.
Hillcrest Park	1.0	Planning permission granted (2020/0035) for the construction of 4 additional light industrial units for B1/2 uses.
Colwick Quays	0.8	Extant planning permission for 3,200 sqm Mixed B1-B8 on 0.8ha of land.
TOTAL	19.35	

Source: Gedling Borough Council 2021 / Lichfields analysis

9.59

The latest AMR March 2020 includes some new planning permissions which increases the supply to 23.8 ha (page 39 and 40 of the 2020 AMR) but does not take into account the now corrected site figures for Top Wighay Farm, Teal Close and Gedling Colliery Chase Farm set out above. If these corrections are taken into account (which will be reflected in the 2021 AMR) then this would result in a March 2020 employment land supply of 20.85 ha, an increase of 1.5 ha on the position two years previously.

9.60 This includes two sites which now have extant planning permission since March 2018. These are:

- Colwick Business Park (located within the Colwick Industrial Estate): Net gain of 3,449 sqm office floorspace on 0.5ha of land;
- Victoria Retail Park: 618 sqm of B1 and B8 on 1 hectare of land.

9.61 A comparison of estimated demand for employment space against all currently identified supply (as of 2018) in Gedling Borough, as shown in Table 9.7, implies that depending on the scale of loss replacement targeted by the Council, there would be insufficient office floorspace and industrial land in quantitative terms to accommodate all of the scenarios, excepting past take up. Given the comparatively high housing need target of 458 dpa, this could be associated with an increase in the labour supply capable of requiring around 32 ha of industrial land, and over 16,200 sqm of office floorspace. Even the lower Experian September 2020 baseline (Scenario 1) would suggest that Gedling Borough requires 11,789 sqm of office floorspace, and 22 ha of industrial / distribution land.

Table 9.7 Demand/Supply Balance of Employment Space 2018-2038 for Gedling Borough

		Office / Industrial Supply as of 31 st March 2018	Need for Offices 2018-38 (sqm)		Need for Industrial / Distribution 2018-38 (ha)	
			Experian/Labour Supply Range	Past Take Up Scenario	Experian / Labour Supply Range	Past Take Up Scenario
Gedling	Net	19.35 ha	7,933 - 12,345	23,069	12.45 – 22.26	0.48
	Gross		11,789 - 16,201	26,925	21.98 – 31.80	10.01

Source: Lichfields' analysis / GBC

9.62 Lichfields appraised the following employment site (with available land) in addition to the existing commitments referred to in Table 9.6 and Colwick Business Park / Victoria Retail Park above:

- GBC 1 Colwick Industrial Estate (**5.5 ha**): In addition to the Colwick Business Park area referred to above, this very large Industrial Estate (Protected for Employment Uses in Policy LPD 44 of the adopted Local Plan) potentially has available land within its boundaries, calculated on the basis of two vacant 'Total' petrol sites (4.39ha) and vacant former general industrial land (1.11ha) on the site. Albeit, an area of the 'Total' petrol site comprising of approximately 2 ha is now subject to a planning application for storage and distribution (ref. 2021/0058).

9.63 Bringing the land supply situation up to date as of 31st March 2020, the supply position increases to 20.85 ha, plus (potentially) the 5.5 ha on the Colwick Industrial Estate which would increase the figure to 26.35 ha. This would be sufficient at the lower end of the range; however, this would still be insufficient at the upper end of the employment land requirement range. If no new sites are forthcoming, this would indicate that to bring the supply back into balance (at the upper end of the range), the Council may wish to consider providing a lower level of loss replacement, identify new sites; or export some of the need to

adjoining districts in the HMA (such as Rushcliffe or Erewash) which have higher levels of supply.

Nottingham City

- 9.64 Part 2 of Nottingham City's Local Plan, *The Land and Planning Policies* document, was adopted in January 2020 and contains Development Management planning policies and site-specific land allocations. Policy EE1 (Providing a Range of Employment Sites) outlines that provision will be made for a minimum of 253,000 sqm for office floorspace and around 25 ha for other employment uses in the City.
- 9.65 In 2018 there was a supply of **236,150 sqm office floorspace and 23.15 ha land** for other employment uses. At 31st March 2020 there was 233,823 sqm of offices floorspace and 21.35 ha of land for industrial/warehousing.
- 9.66 A comparison of estimated demand for employment space against all currently identified supply (as of 2018) in Nottingham City, is provided in Table 9.8.
- 9.67 It is clear that, given the scale of loss replacement, the past take-up scenario is not an appropriate one for NCC to follow for either the office or industrial/warehouse land requirements. The remaining econometric/labour supply scenarios indicate that, depending on the scale of loss replacement targeted by the Council, there would be insufficient office floorspace and industrial land in quantitative terms to accommodate all of the remaining scenarios. There is clearly a need for additional office floorspace of at least 26,170 sqm (2014-based SNPP scenario) rising to 64,970 sqm (Current SM scenario). Furthermore, whilst there is minimal need for general industrial land, there is a strong need for light industrial and particularly distribution B8 land for every scenario, with the March 2020 Experian (pre-Pandemic) scenario suggesting that the gross need for B8 could be as high as 38 ha, 15 ha more than the entire industrial/B8 supply in 2018.

Table 9.8 Demand/Supply Balance of Employment Space 2018-2038 for Nottingham City

		Office Supply as of 31 st March 2018	Need for Offices 2018-38 (sqm)		Industrial / B8 Supply as of 31 st March 2018	Need for Industrial / Distribution 2018-38 (ha)	
			Experian/Labour Supply Range	Past Take Up Scenario		Experian / Labour Supply Range	Past Take Up Scenario
Nottingham	Net	236,150 sqm	118,662 – 157,462	-166,755	23.15 ha	-2.12 - 18.23	-37.30
	Gross		262,320 – 301,120	-23,097		38.85 - 59.19	3.66

Source: Lichfields' analysis / NCC

- 9.68 Of the 27 strategic employment sites Lichfields appraised as part of this study, 12 had available land that could come forward for employment use. These included 17 existing commitments already included in the supply figures in the Table above:
- NCC1 Glaisdale Industrial Estate (2.93 ha) - The site is allocated within the Nottingham City Local Plan as a Major Business Park/Industrial Estate (Local Plan Policy EE2) and rated as 'Good' following Lichfields' site appraisal;

- NCC2 Blenheim Industrial Estate (7.05 ha) - The site is allocated within the Nottingham City Local Plan as a Major Business Park/Industrial Estate (Local Plan Policy EE2) and rated as 'Good' following Lichfields' site appraisal;
- NCC6 Stanton Tip – Hempshill Vale (31.95 ha) - The site is allocated within the adopted Nottingham City Local Plan as a Strategic Regeneration site (Local Plan Policy RE7, site reference SR11) for a mixed-use development comprising of 350 dwellings, 5-10ha of industrial or warehousing units and small-scale retail) and rated as 'Average' following Lichfields' site appraisal. Therefore, whilst the net developable area of the entire site is around 32 ha, only a proportion of this (estimated by the Council at between 5-10 ha) is likely to come forward for employment uses.
- NCC7 Canal Quarter – Island Site (7.02 ha) - The site is located within the Nottingham City Local Plan as part of the Canal and Creative Quarter (Local Plan Policy RE2 and RE3). The site is also designated as a development site (Local Plan Policy SA1, site reference SR59) for the provision of 500 dwellings, 43,900 sqm. of office floorspace (min approx.) and 3,000 sqm. of retail floorspace (min. approx.). The estimated NDA of 7.02 ha in the appraisal form is based on the illustrative masterplan accompanying the outline planning application for the site (application 18/01354/POUT) The site was rated as 'Good' following Lichfields' site appraisal.
- NCC12 Bar Lane Industrial Estate, East of Percy Street (0.20 ha) - The site is safeguarded within the Nottingham City Local Plan as an Existing Business Park/Industrial Estate (Local Plan Policy EE2) and was rated as Average/Poor following Lichfields' site appraisal;
- NCC16 Riverside/Lenton Lane (Boots/Abbeyfield Road - Boots Site) (13.97 ha, based on the areas identified for employment uses in the masterplan). The site is allocated as a development site (Local Plan Policy SA1, site reference SR45) for 200-260 dwellings, 2,500-6,500 sqm of office space and between 5-15 ha of industrial/warehousing units. The site is also designated as an Enterprise Zone and a Major Business/Industrial Estate (Local Plan Policy EE2);
- NCC17 Riverside/Lenton Lane (Abbeyfield Road - East of Beeston Canal) (6.77 ha of vacant land within the site boundaries): The site is designated as a Major Business Park/Industrial Estate (Local Plan Policy EE2) within the Nottingham City Local Plan. The majority of the site is also allocated as a development site (Local Plan Policy SA1, site reference SR46) for B1, B2 and B8 use that compliments and strengthens the existing employment character of the area;
- NCC19 Riverside/Lenton Lane (former Wilford Power Station)/Lenton Lane) (5.57 ha): The site is allocated as a Major Business Park / Industrial Estate (Policy EE2) within the Nottingham City Local Plan. An area of land (2.3ha) along Tottle Road / Queens Drive is also allocated as a development site (Local Plan Policy SA1, site reference SR44, Electric Avenue) for 4,400 sqm of office floorspace or light industrial (B1) use. Any forthcoming development on this current vacant area of land must be conscious of Conservation Area (Wilford Village, Policy HE1) and Archaeological

Constraints designation on the opposite river bank. A former depot within the site appears to be vacant (approximately 3.27 ha) which has some potential to be redeveloped for last mile logistics development.

- NCC23 NG2 Business Park (2.72 ha): The site is allocated within the Nottingham City Local Plan as a Major Business Park / Industrial Estate (Local Plan Policy EE2). The east and western quarters of the site are also allocated as development sites (Local Plan Policy SA1, site references SR41 and SR42). The Local Plan Part 2 has identified these sites for the construction of approximately 13,000-15,000 sqm and 10,000-12,000 sqm of office space respectively.
- NCC25 Creative Quarter (0.094 ha): Three development sites are allocated within the western boundary of the site (Local Plan Policy SA1). These include Brook Street East (site ref SR54) for 43 dwellings; Sneinton Market (SR55) for a mixed-use scheme of 100-120 dwellings, small scale office and retail facilities with leisure and community uses; and Bus Depot (SR56) for a second mixed use development of 100-170 dwellings, 5,000 sqm of office floorspace (maximum estimate), small scale retail, leisure and conference/convention centre.

9.69 Other sites that Lichfields appraised which are not specifically allocated for employment use, but which could potentially have a more modest role in contributing to the overall shortfall in need included:

- NCC11 Bar Lane Industrial Estate, Basford Road (**0.11 ha**, relating to the former Vedonis factory and office in the north-east of the site). Site rated as being 'Average/Poor', with a recommendation that the site should be protected for employment use, although this should be monitored going forward and kept under review if vacancies increase.
- NCC14 Nottingham Business Park – (**2.0 ha**) – following Lichfields' site appraisal, which rated the site as being 'Good', it was recommended that the site should be allocated as a Major Business/Industrial Estate with the boundary amended to exclude the residential use to the south.

9.70 Even if sites NCC12 and NCC14 are included in the total supply, given the constrained nature of Nottingham City it is likely that some or all of this additional need may have to be exported to neighbouring Boroughs in the Core HMA (and potentially Hucknall), unless the Council significantly reduces the indicative loss replacement assumed in the Table above.

9.71 It should be noted that the supply identified above relates only to available land. Currently developed brownfield sites may become available for redevelopment and could be intensified in use to provide more employment floorspace on existing sites. It should be noted that this study assessed 27 strategic employment sites across Nottingham City and did not assess all allocated employment sites. It is understood that the Council will be undertaking this wider exercise separately to this study.

Rushcliffe Borough

- 9.72 Part 1 of the Rushcliffe Local Plan (Core Strategy) was adopted in December 2014 and establishes the strategic approach to new development in the Borough whilst identifying the main strategic allocations. Policy 5 (Employment provision and economic development) outlines how the economy of Rushcliffe will be strengthened and diversified with new floorspace being provided across all employment sectors. The policy allocates a minimum of **67,900 sqm** of office floorspace and **20 ha of land for industrial and warehouse use**.
- 9.73 In this regard, monitoring data provided by Rushcliffe Borough Council Officers indicates that there are currently 30 sites across the Borough that are either allocated for employment use (or mixed use with a significant component of office, industrial or warehousing land), or have an extant planning permission for that use.
- 9.74 This equates to a total of around 46,190 sqm of office floorspace commitments, and 65.44 ha of light industrial, general industrial, and warehousing land as at 31st April 2020. In comparison, office supply was 46,696 sqm as at April 2018 and industrial and warehousing land was at 47.8 ha. This includes some large developments, including:
- **East and West of Nottingham Road**, Barton in Farbis (Local Plan Allocation, plus Planning Application Reference 14/01417/OUT): 20 ha site, with the Transport Assessment that accompanied the application stating that the land uses would be split as follows: Office – 20,000 sqm; B2 (Industrial) – 40,000 sqm; B8 (Distribution) – 40,000 sqm. The Permission is tied to this mix.
 - **Land North of Bingham** (Local Plan Allocation, plus Planning Application Reference 10/01962/OUT): 14.16 ha site, for (former) B1c, B2 and B8.
 - **Former RAF Newton** (Local Plan Allocation, plus Planning Application Reference 10/02105/OUT): Transport assessment assumes 8,000 sqm B1a and 17,800 sqm other B uses.
 - **East of Gamston North of Tollerton (Local Plan Allocation): 9 ha non B1a and 3 Ha of Office (12,000 sqm)**. Out of the total 20 ha proposed employment land across the larger site, 8 ha is already developed towards the airport (4 ha for storage and 4 ha for alternative use). Therefore, out of the total 20 ha of employment land, there is 12 ha remaining.

9.75 A comparison of estimated demand for employment space against all currently identified supply (as of 2018) in Rushcliffe Borough, is provided in Table 9.9.

9.76 Whilst the office floorspace supply is a good fit with the Experian / labour supply range, sitting broadly towards the middle of the upper and lower figures and being very similar to the requirement identified under the Experian March 2020 Baseline (47,814 sqm) and Current SM (604 dpa) scenario (49,143 sqm), there is a much greater discrepancy with the industrial and B8 supply. Even at the upper end of the modelling range (Experian March 2020 baseline, at 22.5 ha), the current land supply is still 25 ha higher.

Table 9.9 Demand/Supply Balance of Employment Space 2018-2038 for Rushcliffe Borough

		Office Supply as of 31 st March 2018	Need for Offices 2018-38 (sqm)		Industrial / B8 Supply as of 31 st March 2018	Need for Industrial / Distribution 2018-38 (ha)	
			Experian/Labour Supply Range	Past Take Up Scenario		Experian / Labour Supply Range	Past Take Up Scenario
Rushcliffe	Net	46,696 sqm	28,800 - 39,706	12,452	47.8 ha	1.83 - 10.21	5.70
	Gross		41,072 - 51,978	24,724		14.09 - 22.46	17.96

Source: Lichfields' analysis / RBC

9.77 Lichfields appraised the following employment sites (with available land) in addition to the existing commitments referred to in Table 9.9:

- RBC 4 Ratcliffe-on-Soar Power Station (206.81 ha net):** This site is occupied by the Uniper Energy Ratcliffe-on-Soar Coal-Fired Power Station. The northern portion of the site accommodates the main power station and goods railway line access. The southern portion of the site is currently in use for ash reclamation. The site was commissioned in 1968 and has previously operated 24/7 with up to 1,000 people working on-site. However, the site is now operating in more of a reserve capacity and it is due to be decommissioned in 2025. A representative of Uniper Ratcliffe Redevelopment advised that Uniper are working with the East Midlands Development Corporation on proposals for transforming the site into ZERO, a global research centre that will develop real-world low-emission technologies, which open up new business markets and help the UK hit its climate change targets. The site is now part of the East Midlands Airport Freeport, one of 8 designated by the Government in its March 2021 Budget with the aim of reducing administrative burdens and tariff controls, provide relief from duties and import taxes, and ease tax and planning regulations. Lichfields' site appraisal concluded that this is an important employment site for the region and key employer with significant potential for redevelopment for zero-carbon technology, advanced manufacturing and Research and Development uses as the site is decommissioned. It is recommended that the site should be allocated for employment uses. The part of the site located adjacent to the East Midlands Parkway Railway Station is suitable for research & development uses; the part of the site south of the A453 is suitable for a science park and advanced manufacturing uses; whilst more energy-intensive low-carbon technology industries on that part of the site that lies to the north of the A453.

- 9.78 The commercial agent discussions in Section 5.0 indicates that the market considers supply to have been constrained in recent years in Rushcliffe Borough, and that past take up in particular does not relate well to the scale of latent demand for industrial / distribution sites given the excellent strategic connectivity and location towards the south of the HMA. This being the case, it may be appropriate for RBC to consider a higher level of loss replacement, or to take on board some of the unmet need from Nottingham City in particular.

Outer HMA

Ashfield District

- 9.79 Ashfield District Council is currently preparing a new Local Plan. At the time of writing, the saved policies of Ashfield's Local Plan (adopted in 2002)¹⁰⁴ remains the principal local planning framework for the District. Policy EM1 allocates a total of **194.3 ha (gross)** for employment development across 35 sites in the District.
- 9.80 The latest 2020 supply figure has been provided by ADC from Table 14 of the Ashfield Employment Land Monitoring Report 2020, which indicates that as of 31st March 2020 the District had a total of **49.07 ha of employment land available, of which 26.1 ha was in Hucknall**. It is noted that land at Pinxton Lane and Castlewood Business Park is likely to be reduced due to the proximity of the safeguarded HS2 rail route.
- 9.81 Officers have confirmed that the 49.07 ha figure reflects an approximate net developable area from the supply side. It also reflects the sites anticipated to be realistically available.
- 9.82 Table 9.10 also compares the 2020 data with the previous year's supply position, which is identical save for the substantial Amazon development at Summit Park, which was developed in 2019/20, and 6.95 ha which was developed at Castlewood Business Park in 2018/19. These two large developments reduced the total supply from 75.47 ha to 49.07 ha.

¹⁰⁴ Ashfield District Council (2002): *Ashfield Local Plan: Saved Policies*

Table 9.10 Extant employment land supply in Ashfield District Council

Site	ADC 2002 Local Plan Allocation	Approx. Net Developable Area as of 31 st March 2020		Approx. Net Developable Area as of 31 st March 2018	
		District-wide	...of which in Hucknall	District-wide	...of which in Hucknall
Rolls Royce	EM1 Ha (and also planning permission)	20.33	20.33	20.33	20.33
Butlers Hill	EM1 He	1.78	1.78	1.78	1.78
Blenheim Lane	EM1 Ra	3.16	3.16	3.16	3.16
Aerial Way	EM1 Hc	0.83	0.83	0.83	0.83
West of Fulwood	EM1 Sb	4.54		4.54	
Summit Park	EM1 Re	2.34		21.64	
South West Oakham	EM1 Re	1.52		1.52	
Kings Mill Road	EM1 Ke	1.99		1.99	
Park Lane	EM1 Rd	1.84		1.84	
Portland Ind Park	EM1 Kc	1.76		1.76	
Castlewood Bus Park*	EM1 Sa	7.75		14.70	
Fulwood Road North	EM1 Sf	1.23		1.38	
TOTAL		49.07	26.10	75.47	26.10

Source: Ashfield District Council 2020 Employment Land Monitoring Report Table 14 / ADC Officers

*Note: High Speed 2b rail route is anticipated to have an impact on the supply at Pinxton Lane and Castlewood.

9.83 The latest Monitoring Report reflects the allocations set out in the Local Plan the Ashfield Local Plan Review 2002. Appendix One reflects the existing Plan allocations where most of the sites were identified as the gross developable area, which over-estimates the land available to be developed. For example, Rolls Royce Harrier Park is put in at a gross figure to be consistent and is shown as 27 ha, although the developable area is anticipated to be significantly lower (20.33 ha).

9.84 In relation to other units on allocated sites:

- Castlewood Business Park, Plot 1 (developer's particulars) (Pinxton Lane has planning permission for 19,235 sqm (V/ 2018/0652).
- South West of Oakham Business Park has permission for development of 9,550 sqm of floorspace (V/ 2019/0416).
- Park Lane Business Park (Bentinck Colliery) has planning permission for an industrial unit comprising 2,612 sqm of floorspace. (V/2019/0677).
- Work has started on a unit on Harrier Park, Hucknall to construct a unit of 18,194 sqm floorspace (V/2019/0433).

9.85 The Council also considers that there are a number of other sites in Appendix One which are unlikely to be taken forward for employment (some already have permission for residential but not yet taken forward for this purpose but unless the market changes they will not come forward for employment)¹⁰⁵.

¹⁰⁵ As set out in paragraph 3.3 of ADC's 2020 Employment Land Monitoring Report, At Brierley Industrial Park (EM1 Sn) 0.73 ha is being utilised by a business for the storages of motorhomes, whilst Land comprising 0.8 ha off Watnall Road, allocation EM1Hb is being used for the open storage of materials.

- 9.86 Officers have also commented that other sites which are allocated in the Plan are unlikely to be developed due to viability issues (e.g. Maun Valley) or access issues (e.g. Wigwam Lane).

Table 9.11 Demand/Supply Balance of Employment Space 2018-2038 for Ashfield District and Hucknall

		Office / Industrial Supply as of 31 st March 2018	Need for Offices 2018-38 (sqm)		Need for Industrial / Distribution 2018-38 (ha)	
			Experian/Labour Supply Range	Past Take Up Scenario	Experian / Labour Supply Range	Past Take Up Scenario
Ashfield	Net	75.47 ha	13,165 - 23,396	26,664	4.68 – 15.53	76.87
	Gross		23,898 - 33,956	37,224	46.71 – 57.56	118.90
Hucknall	Net	26.10 ha	1,785 - 3,988	308	0.88 – 6.07	13.85
	Gross		2,305 - 4,508	828	9.74 – 14.93	22.71

Source: Lichfields' analysis / ADC

- 9.87 The data suggests that there is perhaps a modest imbalance in Hucknall town, with a supply of 26.1 ha as against a requirement of up to 23 ha based on past take up. This is less relevant given the overall under-supply District-wide, based on the past take up rate which suggests up to 119 ha could be required over the 20 years to 2038. As set out in detail above, this take up figure is likely to have been inflated somewhat by some very large B8 distribution sites coming forward most notably the Amazon Distribution depot at Summit Park for c. 19 ha in 2019/20. The econometric / labour supply modelling, which is unlikely to factor in the needs of large scale B8, suggests that a lower level of need equal to between 47- 56 ha could be required of light/general industrial and B8 distribution.
- 9.88 With the exception of sites ADC12/13, ADC14 and ADC15, all of the sites that Lichfields appraised as part of this study were existing allocations or otherwise committed employment sites included in Table 9.11 above.
- As we have set out above, if the Outer HMA authorities are to grasp the opportunity offered by B8 strategic distribution, Ashfield has a number of sites in close proximity to M1 junctions which could be considered ideal to accommodate this key growth sector. ***Mansfield District***
- 9.89 In September 2020, Mansfield District Council adopted the Mansfield District Local Plan 2013-2033¹⁰⁶. The Local Plan replaced all the remaining saved policies of the 1998 Mansfield District Local Plan and now forms part of the statutory development plan. The Plan has an employment land target of 41 ha over the period 2013-33, and states that the employment land supply will be met from a variety of sources including completions, extant planning permissions, vacant plots within protected key and general employment areas and new employment allocations.
- 9.90 Table 6.3 of the Plan sets out the contribution from various sources and suggests that as of 1st April 2019, the District had a forward supply of **50.73** ha

¹⁰⁶ Mansfield District Council (2020): *MDC Adopted Local Plan 2013-2033*

of employment land (excluding the 2.82 ha already developed over the plan period to date). This is an increase of 15.53 ha on the supply position on 31st March 2018 due to the inclusion of 5 large Local Plan allocations in the intervening period.

Table 9.12 Employment Land Provision

Plan Period Employment Land Target ha 2013-2020	2019 Local Plan Employment Land (ha) Position	2018 AMR Employment Land (ha) Position
Local Plan Target	41*	n/a
Total amount of floorspace /employment land developed between 1/4/13 and 1/4/19	2.82	2.38
Loss of employment land 2013/2019	-0.98	-0.94
Sites with planning permission	23.83	24.65
Local Plan allocations	17.95	n/a
<i>Pleasley Hill Farm - SUE 1</i>	1.76	-
<i>Land off Jubilee Way - SUE 2</i>	1.6	-
<i>Ratcher Hill Quarry Employment Area - E2a</i>	3.45	-
<i>Oakfield Lane, Market Warsop - E2b</i>	2.2	-
<i>Penniment Farm - E2c</i>	9	-
Sites Available on Key and General Employment Areas	8.95	10.55
TOTAL Available as of 31st March 2019	50.73 ha	35.2 ha

Source: Mansfield District Local Plan 2020 / MDC Employment Monitoring Reports

*38ha of B1c/B2 and B8 land and 3ha of employment land for B1a office space

9.91 A comparison of estimated demand for employment space against all currently identified supply in Mansfield District is shown in Table 9.13. Against a total supply of 35.2 ha (benchmarked to 2018 for consistency), the indicative gross requirements are generally lower, even if office floorspace is converted to land through the application of a 40% plot ratio. Under the most optimistic Regeneration scenario, this could equate to around 36 ha, which is a close fit with the 2018 supply position, although well below the higher 2020 position of 50.73 ha.

Table 9.13 Demand/Supply Balance of Employment Space 2018-2038 for Mansfield District

		Office / Industrial Supply as of 31 st March 2018	Need for Offices 2018-38 (sqm)		Need for Industrial / Distribution 2018-38 (ha)	
			Experian/Labour Supply Range	Past Take Up Scenario	Experian / Labour Supply Range	Past Take Up Scenario
Mansfield	Net	35.2 ha	8,555 – 13,638	-17,865	5.25 – 12.12	12.62
	Gross		37,603 -42,686	11,183	18.94 – 25.80	26.31

Source: Lichfields' analysis / MDC

9.92 All of the sites that Lichfields appraised as part of this study were existing allocations or otherwise committed employment sites included in Table 9.13.

9.93 If no new sites are forthcoming, this would indicate that to bring the supply back into balance (as of 2020), the Council may wish to consider providing a higher level of loss replacement, release some more employment sites from the portfolio, or import some of the need from adjoining districts which have lower levels of supply.

Newark & Sherwood District

- 9.94 Newark and Sherwood District Council adopted its Amended Core Strategy DPD in March 2019. The document sets out a vision and objectives and a number of policies to help deliver the development and change identified. Spatial Policy 2 (Spatial Distribution of Growth) outlines where growth will be focused across the district. The policy also outlines the employment land requirement for Newark and Sherwood between 2013 and 2033 (this being **83.1 ha**).
- 9.95 N&SDC Officers have provided up to date information on employment land allocations and permissions. This totals **82.05 ha across 34 sites**, including:
- Plot 9 Brunel Business Park Jessop Close Newark On Trent 18/00018/FULM – 23 industrial units totalling 1.1 ha;
 - Mercia Garden Products Ltd Old Great North Road Sutton On Trent 17/01976/FULM - Storage unit attached to current factory unit for 4.12 ha;
 - Clipper Logistics Group Ltd Boughton Industrial Estate 11/00768/FULM - Erection of an extension to B8 warehouse building over 3.25 ha;
 - A17 Winthorpe Nottinghamshire 16/01796/FULM - Vehicle/plant servicing and repair workshop, storage, office, sales etc over 9.9 ha;
 - Thoresby Colliery 16/02173/OUTM – Mix of office, light industrial and general industrial units c. 8 ha;
 - Land N and S of Cross Lane 07/01081/OUTM - B1 Business development of up to 47,500 square metres – 12.78 ha;
 - Staunton Works Alverton Road Staunton 09/00995/FULM – Change of Use for storage 5.96 ha;
 - Murphy Pipelines Ltd 18/02090/FUL - Replacement of temporary structures and erection of a two-storey building in existing yard. – 1.02 ha;
 - Belle Eau Park 04/01076/FUL - Proposed new quality assurance building – 1.9 ha;
 - Blidworth Industrial Park 15/00662/FULM - Proposed Industrial Units – 0.33 ha.
- 9.96 This figure is higher than the 63.35 ha of commitments as at 1st April 2018 identified in NSDC's 2018 Employment Land Availability Study [ELAS]. A comparison of estimated demand for employment space against all currently identified supply in Newark & Sherwood District is shown in Table 9.14. The 2018 supply position, taken from the 2018 ELAS, comprises 63.35 ha of commitments with extant planning permission; 33.56 ha of available employment land in a designated employment area; 15 ha remaining from the Core Strategy allocation (Land around Fernwood); and 48.28 ha from sites in the adopted allocations and development management DPD (without a valid planning permission).
- 9.97 Against a total supply of **160.19 ha**, the past take up scenario suggests a need for almost 100 ha of industrial / distribution land, plus a further 80,180 sqm of office floorspace. This reflects the consistently high levels of delivery Newark & Sherwood has experienced over the past 11 years or more, and does not even

take into account the 19.05 ha Dixons Mastercare site (which was delivered before the start of the current monitoring period in 2006/07).

9.98 The econometric and labour supply models suggest a lower level of need, of up to 55.69 ha based on the Regeneration Scenario (again converting the office floorspace to land).

9.99 The 160.19 ha supply is clearly in excess of all of the scenarios including the past take up scenario.

Table 9.14 Demand/Supply Balance of Employment Space 2018-2038 for Newark & Sherwood District

		Office / Industrial Supply as of 1 st April 2018	Need for Offices 2018-38 (sqm)		Need for Industrial / Distribution 2018-38 (ha)	
			Experian/Labour Supply Range	Past Take Up Scenario	Experian / Labour Supply Range	Past Take Up Scenario
Newark & Sherwood	Net	160.19 ha	11,180 – 24,296	44,959	8.27 - 23.74	81.78
	Gross		46,404 – 59,520	80,183	26.47 – 41.95	99.99

Source: Lichfields' analysis / NDCD

9.100 It should be noted that of this supply, Lichfields recommended that the Staunton Works site, on Alverton Road (NSDC9) should not be allocated for employment uses. As this is included in Table 9.14, if this were to be removed, it would reduce the supply by 5.96 ha (and down to 154.23 ha).

9.101 Lichfields appraised the following employment sites (with available land) and recommended that they would be suitable for employment use:

- **NSDC3 Land off Beacon Hill Road (G Park) (16 ha net):** This site is contained within the Newark Industrial Estate Policy Area (NUA/E/1, Allocations & Development Management DPD, 2013). This is currently on the market for build-to-suit logistics/warehouse up to 70,978 sqm and marketed as G-Park.
- **NSDC4 British Sugar (5 ha):** The site is undesignated within the LDF, although 540 sqm relating the Erection of 2no portal frame buildings for storage of topsoil (planning ref: 09/01413/FUL) is included in Table 9.14. The site appraisal recommended that the British Sugar site should be protected for ongoing employment uses, with the undeveloped land allocated for employment uses.
- **NSDC7 Land North and South of Cross Lane (7.38 ha):** The site is allocated as a Strategic Site (*NAP 2C Land around Fernwood and Core Strategy Spatial Policy 5*); it is identified for Use Class E office development. It is also included within the Newark Urban Area – Phasing Policy (NUA/Ph/1) (Allocations & Development Management DPD, 2013). The site appraisal recommended that the Strategic site allocation (Land around Fernwood – NAP 2C) should be retained for Use Class E office development. However, in reality, it is unlikely that the whole site will come forward for Use Class E office development and there is likely to be an element of mixed-use development, which would reduce the net developable area.
- **NSDC12 Crew Lane Industrial Area, Southwell (4.65 ha):** The site is allocated as an Industrial Estate/Existing Employment Area (So/E/1 –

Southwell – Crew Lane Industrial Estate Policy Area) (Allocations & Development Management DPD, 2013). Two areas of undeveloped land are designated within the east and south of the site as new employment areas within the collective Industrial Estate – So/E/2 (2.71ha) and So/E/3 (2.18ha), or 4.65 ha with a 95% gross to net adjustment. The net developable area for this site has been reduced to **2.71 ha** based on the recommendation in the proforma to allocate So/E/2 for employment uses and to consider safeguarding So/E/3 for employment uses, with potential future scope for an element of mixed-use development.

- **NSDC15 Sherwood Energy Village (2ha):** This is the site of the former Ollerton Colliery. The colliery closed in 1994 and the site is being redeveloped into The Sherwood Energy Village, an environmentally friendly business park. Lichfields' site appraisal recommended that the Council should allocate sites identified in the Allocations & Development Management DPD (2013) as having planning permission for employment (E PP) within the western site for employment uses; retain the eastern site identified as having planning permission for residential (Ho PP) for residential uses; and protect the recreational space on the central teardrop shaped sites. The small site to west of the central sites should not be allocated, given it has been developed for residential apartments.
- **NSDC22 Land west of the A1 on Stephenson Way (NUA/E/2) (7.56 ha):** This site is allocated for employment development (NUA/E/2 – Newark Urban Area – Employment Site 2, Allocations & Development Management DPD, 2013). It is also partially included in the Council's committed development list, with 4 extant applications for employment use totalling 2.73 ha. This suggests that **around 4.83 ha remains on the site to be developed, and which can be included in the supply.**
- **NSDC23 Land south of Newark (43.89 ha):** This is a large undeveloped greenfield site to the south of Newark-upon-Trent. The site forms part of the Strategic Site Designation Land South of Newark – NAP 2A. The sustainable urban extension comprises of up to 3,150 new homes, a strategic link road between the A1 and A46 and 49 ha of employment, as well as community facilities and open spaces. Outline permission has been granted for the wider development known as 'Middlebeck' with reserved matters permission for the first phases, development of these is underway. This site is identified for employment development within the approved outline planning permission. Lichfields estimates that with a 90% gross to net adjustment, the site could deliver c.44 ha of employment land.
- **NSDC24 Land around Fernwood (13.49 ha):** The site is allocated as a Strategic Site (Land around Fernwood – NAP 2C) and Spatial Policy 5 (Delivering the Strategy) in the Core Strategy, 2019), it is identified for Use Class E office development. Lichfields estimates that with a 95% gross to net adjustment, the site could deliver 13.5 ha of employment land. However, in reality, it is unlikely that the whole site will come forward for Use Class E office development and there is likely to be an element of mixed-use development.

- **NSDC26 Former Clipstone Colliery (10.8 ha):** This is a former colliery site, the majority of which is now grassland, with just the abandoned headstocks and powerhouse remaining. It is allocated as a mixed-use site with Planning Permission - CI/MU/1, Clipstone – Mixed Use Site 1. The site appraisal recommended that the current allocation as a mixed-use site be retained. This would equate to 12 ha (gross), or an estimated 10.8 ha net, for employment with scope for a modest element of Use Class E Office development.

10.0 **Conclusions and Policy Recommendations**

10.1 This section draws together the overall conclusions of the Nottingham Core and Outer HMA Employment Land Needs Study and considers the potential planning and economic strategy responses in terms of framing policies for employment land, highlighting key decisions that the Councils will need to make and potential areas of further work.

FEMA and Meeting Unmet Needs

10.2 This study has updated the Functional Economic Market Area [FEMA] assessment undertaken in the original 2015 ELFS to examine whether the five Core HMA and 3 Outer HMA districts formed distinct self-contained FEMAs. On balance, it is considered that the Core HMA forms a self-contained FEMA. Despite the FEMA tests indicating a slightly less conclusive result once applied to three Outer HMA districts, an argument can be made that the Outer HMA is also a self-contained FEMA. With regards to Hucknall, as with the previous 2015 ELFS, this updated study considers that whilst it is within the administrative boundaries of Ashfield/Outer HMA, Hucknall is highly connected to the Core HMA and could be viewed as being located within that FEMA due to its high connectivity with Nottingham City, both physically and from a commercial market perspective.

10.3 As required by the NPPF and PPG, Lichfields also engaged with Planning Officers representing the districts that adjoin the 8 Nottingham Core/Outer HMAs to understand whether there was an unmet need in any of these districts that could be met, in full or in part, in the study area (or, conversely, whether any of these adjoining districts would be in a position to take on board any of the study area's employment land requirements). The discussion also sought to inform the ELNS of existing or committed employment developments in their area, which might have the potential to impact, or otherwise distort, the commercial and industrial market in Greater Nottingham. An obvious example in this regard is the SEGRO East Midlands Gateway site in North West Leicestershire, which is a very large and successful SRFI that is part constructed with a further 3,000,000 sq ft available that is likely to be meeting at least some of south Nottinghamshire's B8 distribution needs, as well as the East Midlands Distribution Centre, the proposed Aldi Distribution Centre (Coalville) and developments at Junction 1 (A50) near Castle Donnington.

10.4 Lichfields contacted Planning Officers from all of the adjoining districts and received responses from North Kesteven and West Lindsay; South Kesteven; Melton; Charnwood; North West Leicestershire; South Derbyshire; Derby City; Amber Valley; and Bolsover.

10.5 Generally, the Councils confirmed that they are meeting their own needs in terms of employment land, with their emerging evidence bases indicating that this will continue to be the case for the foreseeable future. None require the Nottingham Core/Outer HMA districts to assist in meeting their unmet needs, although Melton Borough Council did express an interest in a future discussion around sharing employment land needs cross-boundary. Derby City Council

also stressed the potential future importance of the A52 as a potential growth corridor linking Derby to the new HS2 station at Toton and to Nottingham beyond.

Employment Land Demand / Supply

- 10.6 This report provides the 8 Nottingham Core/Outer HMA districts' employment land evidence base to inform their emerging Local Plans. In light of the pandemic and the uncertainties surrounding the consequences of Brexit, Lichfields constructed a series of scenarios that factored in our current understanding of the local impacts of the pandemic within Greater Nottingham, based on the latest available data. In line with the NPPF, it addresses the requirement set out in paragraph 20 which states that plans and decisions should be based on up-to-date and locally specific evidence.
- 10.7 This report has appraised a range of employment land projections for the 8 districts using a variety of methodologies in accordance with the PPG. It has used the latest modelling data from Experian (both post and pre-Pandemic); labour supply scenarios including the recently updated standard methodology for calculating housing need; and updated past take up rates and losses data.
- 10.8 To ensure a flexible and responsive policy framework, it will be necessary not just to focus on meeting forecast quantitative requirements (which will fluctuate over time), but to consider the opportunities and risks that flow from particular policies or types of land allocations. This might concern how delivery can be prioritised in some locations or for some types of employment uses, or how scope can be created for meeting as yet undefined inward investment opportunities.
- 10.9 Six different scenarios of future employment space requirements were considered based on a range of lower and higher growth conditions that could arise in the future, plus a sensitivity test based on past trends jobs growth. The Experian post Covid September 2020 baseline scenario (Scenario 1) forecasts a much lower level of job growth than has been experienced in recent years. Between 1997 and 2018, the Core HMA's economy grew by 37,700 jobs, equal to a CAGR of 0.481%. This is significantly lower than both the East Midlands and UK rates (0.77% and 0.95% respectively) and particularly the three Outer HMA districts which averaged an impressive 1.236% CAGR. Workforce jobs growth has been particularly strong in Nottingham City, Ashfield and Newark & Sherwood Districts, but was actually negative for Erewash and Gedling Boroughs. In contrast however, over the Plan period of 2018-38 the post Covid Experian September 2020 projections reverse the growth trends with the Core HMA districts forecast to experience growth rates of 0.596% overall (in excess of the East Midlands and UK rates), with the Outer HMA rate dropping by nearly two thirds to 0.452%.
- 10.10 Scenario 1 used the September 2020 Experian baseline forecasts and translated these into office, light/general industrial and warehousing floorspace/land requirements. The scenario forecast significant growth in E(g)/B-class jobs for the Core HMA as a whole, equal to 11,991 between 2018 and 2038, although this level of growth is outstripped by more than 3-times this level of growth in the

Non-employment-uses (notably Health, Education and Residential Care and Social Work). As would be expected, there is strong growth in office-based activities of 13,873, although more than two thirds of this is located in Nottingham City. There are some moderate gains in light industrial jobs growth; declining manufacturing employment as previously; and surprisingly minor gains in distribution jobs.

- 10.11 Similar patterns are observed for the Outer HMA, albeit the scale of office employment growth is of a much lower magnitude than in Nottingham City. Again, net job growth relating to B8 distribution appears very low, at just 877 across the whole HMA over the next 20 years, whilst B2 general industrial employment is projected to fall particularly sharply in Ashfield District.
- 10.12 Scenario 2 mirrored the approach in the first scenario, but used pre-Covid 19 data from Experian (dated March 2020) to derive a more optimistic vision of the Nottingham Core/Outer HMA districts' future. The level of job growth across the Core HMAs is 58,700 over the 20-year plan period, 18% higher than the re-calibrated September 2020 model, whilst the net job growth across the three Outer HMA districts is 19,100 (27% higher than the Pandemic-adjusted forecast).
- 10.13 Scenario 3 comprised a Regeneration (or 'Policy On') forecast that accelerated the Experian industrial sectors that aligned with the D2N2 LEP's SEP 11 priority areas. This resulted in an overall increase of 58,608 jobs to 2038 (9,008 higher than the baseline) for the 5 Core HMA districts, and an increase of 20,581 jobs (5,581 higher than the September 2020 baseline) for the three Outer HMA districts. There was also an increase in E/B-Class jobs in the Core HMA districts of 16,539 (5452 higher than previously) and 3,200 E/B Class jobs in the Outer HMA (2,569 higher than in the baseline).
- 10.14 Two labour supply scenarios were also modelled to take into account how many jobs (and hence how much employment space), would be necessary to broadly equate to the future objectively assessed need for housing across the eight Nottinghamshire districts. Scenario 4 comprised of a 'baseline' number of jobs which is expected to be support by the SNPP, whilst a further upper sensitivity test, Scenario 5, provided an 'uplifted' number of jobs which estimated the number of jobs expected to be supported under the standard method with the affordability uplift. These labour supply-based estimates provide a useful benchmark for comparison with labour demand approaches. These projections produced floorspace requirements that generally sat below the Experian and Regeneration job growth scenarios.
- 10.15 The final scenario (6) trended forward monitoring data on past completions by office, industrial (light and general) and distribution uses between 2011/12 and 2019/20 for 6 councils, with Ashfield District and Newark & Sherwood providing more robust data over a slightly longer time period. Losses data was also provided over the comparable timeframe to enable a net figure to be calculated. A total of 14,665 sqm of gross office floorspace completions has come forward per annum in recent years, with the highest levels in Newark & Sherwood (4,814 sqm p.a.) and Nottingham City (2,752 sqm). In contrast,

18,918 sqm of office floorspace has been lost per annum over that same time period, resulting in a negative net floorspace figure of -4,252 sqm per annum.

- 10.16 Regarding industrial / distribution data, the net floorspace delivery rate in the Core HMA totals -3,717 sqm p.a., which is entirely due to Nottingham City's figure of -7,572 sqm (the other 4 districts have modest positive net delivery rates of industrial floorspace). For the Outer HMA, net past take-up averages 31,140 sqm per annum, just under half of which has come forward in Newark & Sherwood.
- 10.17 The modelling factored in a two-year flexibility factor (generally two years' worth of net past take up when that data was positive) to derive a net office floorspace / industrial/distribution land requirement for each district. The study then made suggestions as to the potential scale of loss replacement that the respective Councils may wish to examine further in order to translate the net requirement into a planning requirement, based on an assessment of potential future losses from SHLAA data / commitments; observed past losses; and c.1% churn factor.
- 10.18 The results of this net/gross need assessment, set against the current supply position, are summarised in Table 10.1 and Table 10.2. Where B8 distribution is referred to here, this primarily relates to localised, or indigenous, needs. Strategic logistics needs of national and regional distribution centres are generally not reflected in either the past take-up or econometric modelling data and are discussed later in this section.
- 10.19 The considerable uncertainty regarding changing work practices presented by the Pandemic and further uncertainties concerning the implantations of Brexit means that these conclusions should be revisited by the Councils and monitored as and when new data on the fallout from the 'new economic normal' becomes more clearly apparent in the years to come.

Table 10.1 Demand/Supply Balance of Employment Space 2018-2038 for the Nottingham Core HMA districts

		Office Supply as of 31 st March 2018	Need for Offices 2018-38 (sqm)		Industrial / B8 Supply as of 31 st March 2018	Need for Industrial / Distribution 2018-38 (ha)	
			Experian/Labour Supply Range	Past Take Up Scenario		Experian / Labour Supply Range	Past Take Up Scenario
Broxtowe	Net	n/a	9,642-19,081	14,973	8.54 ha (includes office)	7.87-19.82	14.27
	Gross		28,006-37,445	33,337		26.61-38.56	33.00
Erewash	Net	51,571 sqm	3,876 - 16,065	-2,928	13.89 ha	-13.17 – 1.87	2.00
	Gross		14,587 – 26,776	7,783		24.99 - 40.03	40.16
Gedling	Net	n/a	7,933 - 12,345	23,069	19.35 ha (includes office)	12.45 – 22.26	0.48
	Gross		11,789 – 16,201	26,925		21.98 – 31.80	10.01
Nottingham	Net	236,150 sqm (as of 31 st March 2018)	118,662 – 157,462	-166,755	23.15 ha (as of 31 st March 2018)	-2.12 - 18.23	-37.30
	Gross		262,320 – 301,120	-23,097		38.85 - 59.19	3.66
Rushcliffe	Net	46,696 sqm (as of 31 st March 2018)	28,800 - 39,706	12,452	47.8 ha (as of 31 st March 2018)	1.83 - 10.21	5.70
	Gross		41,072 - 51,978	24,724		14.09 - 22.46	17.96
CORE HMA TOTAL	Net	333,911 sqm	168,913 – 244,659	-119,189	130.37 (includes some office)	6.86 – 72.39	-14.85
	Gross		357,774 – 433,520	69,672		126.52 – 192.04	104.79

Source: Lichfields' analysis / BBC / EBC / GBC / NCC / RBC

10.20

The key demand/supply messages for the five Core HMA districts are as follows:

- Broxtowe Borough:** Depending on the scale of loss replacement targeted by the Council, there would be insufficient office floorspace and industrial land in quantitative terms to accommodate the need arising from any of the modelled scenarios. The past take-up for offices appears to have been distorted by abnormally high levels of delivery in the 2019/20 monitoring year. Even including the remaining available employment land at Boots Campus, Aero Fabrications and Nottingham 26, bringing the supply up to 13.01 ha, this is still insufficient to meet needs ranging from 34 ha to 48 ha, particularly given the Borough's excellent connectivity on the strategic road network, suggesting further sites may need to be allocated (dependant on the scale of loss replacement that the Council decide to allow for).
- Erewash Borough:** there is more than enough office floorspace available (in quantitative terms) to accommodate any of the growth scenarios, including past take up. This is in contrast with the provision of industrial land, which appears insufficient even to meet the lowest (labour supply 2014-based SNPP) scenario, of 24.99 ha. At the upper end of the range, both the Regeneration and Past Take-up Scenarios suggest that there could be a shortfall in the order of around 26 ha. The 85 ha Stanton Regeneration site may have a significant role to play in radically addressing this shortfall, depending on the intentions of the new owners. As set out in Section 9.0, it is likely that following the recent acquisition by Verdant Regeneration Ltd. of

approximately half of the wider site, a proportion of the land is likely to be utilised as a waste recycling facility. It may also have a role to play in meeting wider needs over and above Erewash's own requirements, which would be a policy choice for Erewash to take and one to be agreed with other districts in the Core HMA.

- **Gedling Borough:** the 2018 supply position of 19.35 ha of office floorspace and industrial land is insufficient at present to accommodate any of the growth scenarios (with the exception of past take up). However, the latest AMR March 2020 includes some new planning permissions which increases the supply to 20.85 ha, with the potential for an additional 5.5 ha on the Colwick Industrial Estate. This would bring the supply/demand position closer into balance, albeit if the upper end of the requirement range were pursued then further employment land may need to be identified.
- In this regard, given the comparatively high housing need target of 458 dpa, this could be associated with an increase in the labour supply capable of requiring around 32 ha of industrial land, and over 16,200 sqm of office floorspace. If no new sites are forthcoming, this would indicate that to bring the supply back into balance, the Council may wish to consider providing a lower level of loss replacement, or export some of the need to adjoining districts in the HMA (such as Rushcliffe or Erewash) which have higher levels of supply
- **Nottingham City:** Losses of both office and industrial/warehousing floorspace have been very high in the City in recent years, and as a result the past take up scenario is not an appropriate one for NCC to follow. The remaining econometric/labour supply scenarios indicate that there would be insufficient office floorspace and industrial land in quantitative terms to accommodate all of the remaining scenarios. There is clearly a need for additional office floorspace of at least 26,170 sqm (2014-based SNPP scenario) rising to 64,970 sqm (Current SM scenario). This supports the continued role of Nottingham as a 'safe haven' for office accommodation in the region, which was also backed up by the qualitative commentary provided by the agents, property developers and other stakeholders contacted as part of this study.

Furthermore, whilst there is minimal need for general industrial land, there is a strong need for light industrial and, particularly, distribution B8 land for every scenario, with the March 2020 Experian (pre-Pandemic) scenario suggesting that the gross need for B8 could be as high as 38 ha, 15 ha more than the entire industrial/B8 supply in 2018. Given the constrained nature of Nottingham City, it is likely that some, or all, of this additional need may have to be exported to Rushcliffe or Erewash (and potentially Hucknall).

- **Rushcliffe Borough:** Whilst the office floorspace supply is a good fit with the Experian / labour supply range, there is a much greater discrepancy with the industrial / B8 supply. Even at the upper end of the modelling range (Experian March 2020 baseline, at 22.5 ha), the current land supply is still 25 ha higher, whilst the very large Ratcliffe on Soar Power Station Freeport

site has the potential to increase this imbalance still further if it is redeveloped for zero-carbon technology, advanced manufacturing and Research and Development uses, as the site is decommissioned.

Commercial agents consider supply to have been constrained in recent years in Rushcliffe Borough, and that past take-up in particular, does not relate well to the scale of latent demand for industrial / distribution sites given the excellent strategic connectivity and location towards the south of the HMA. This being the case, it may be appropriate for RBC to consider a higher level of loss replacement, or to take on board some of the unmet need from Nottingham City in particular.

Table 10.2 Demand/Supply Balance of Employment Space 2018-2038 for the Nottingham Outer HMA districts

		Office / Industrial Supply as of 31 st March 2018	Need for Offices 2018-38 (sqm)		Need for Industrial / Distribution 2018-38 (ha)	
			Experian/Labour Supply Range	Past Take Up Scenario	Experian / Labour Supply Range	Past Take Up Scenario
Ashfield	Net	75.47 ha	13,165 - 23,396	26,664	4.68 – 15.53	76.87
	Gross		23,898 - 33,956	37,224	46.71 – 57.56	118.90
Hucknall	Net	26.10 ha	1,785 - 3,988	308	0.88 – 6.07	13.85
	Gross		2,305 - 4,508	828	9.74 – 14.93	22.71
Mansfield	Net	35.2 ha	8,555 – 13,638	-17,865	5.25 – 12.12	12.62
	Gross		37,603 -42,686	11,183	18.94 – 25.80	26.31
Newark & Sherwood	Net	160.19 ha*	11,180 – 24,296	44,959	8.27 – 23.74	81.78
	Gross		46,404 – 59,520	80,183	26.47 – 41.95	99.99
Outer HMA TOTAL	Net	270.86 ha	32,900 – 61,330	53,758	18.2 – 51.39	171.27
	Gross		107,905 – 136,162	128,590	92.12 – 125.31	245.2

Source: Lichfields' analysis / ADC / MDC / N&SDC

*This may include some sites where an element of mixed use would be suitable, and also includes the Staunton Works site (5.96 ha) which Lichfields has recommended should be removed from the portfolio.

10.21

The key demand supply messages for the three Outer HMA districts are as follows:

- **Ashfield District:** There is a significant imbalance in the (2018) supply of employment land in Ashfield District, at 75 ha, when set against the past take up data (77 ha net, 119 ha gross). This take up figure is likely to have been inflated by some very large B8 distribution sites coming forward most notably the Amazon Distribution depot at Summit Park for c. 19 ha in 2019/20. The econometric / labour supply modelling, which does not factor in the needs of large scale B8, suggests that a lower level of need equal to between 47- 58 ha could be required for light/general industrial and B8 distribution. If the Outer HMA authorities are to grasp the opportunity offered by B8 strategic distribution, Ashfield has a number of sites in close

proximity to M1 junctions which could be considered ideal to accommodate this key growth sector.

- As discussed above, Lichfields modelled a sensitivity test for Ashfield District, given that the Council provided data on take-up and losses stretching back to 2000/01. If data over the medium term is used instead, this would point to a lower level of need, between 3,385 sqm and 23,389 sqm for office floorspace, and between 35.03 ha-92.25 ha. This appears to be a closer fit to the current supply (70 ha), although there would still be a shortfall at the upper end of the range. The extent to which the Council may wish to take this range into consideration as part of their Local Plan policy for employment land would be for them to justify.
- **Hucknall:** Given the earlier commentary about Hucknall and the Town's greater relationship with the Core HMA implied by commuting flows, employment land requirements have been set out separately from the figures for Ashfield District. It should be emphasised that data and requirements at a more local scale (i.e. based on groupings of output areas) need to be treated with caution. The figures presented for Hucknall assume that the town's current share of the total jobs/residents in Ashfield District remain the same over the period to 2038, but this is of course subject to change.

The data suggests that there is perhaps a modest imbalance in Hucknall town, with a supply of 26.1 ha as against a requirement of up to 23 ha based on past take up. This is less relevant given the overall under-supply District-wide, based on the past take up rate which suggests up to 119 ha could be required over the 20 years to 2038.

- **Mansfield District:** Against a total supply of c.35 ha in 2018 (rising to 51 ha in 2020), the indicative gross requirements are generally lower, even if office floorspace is converted to land through the application of a 40% plot ratio. However, under the most optimistic scenario (the Regeneration Scenario 3), this equates to around 36 ha, equal to the 2018 supply position (although it is well below the 2020 position). To bring this (current position) back into balance, the Council may wish to consider factoring in a higher level of loss replacement; or release some more employment sites from the portfolio; or import some of the need from adjoining districts which have lower levels of supply.
- **Newark & Sherwood District:** Against a total supply of 160.19 ha, the past take up scenario suggests a need for almost 100 ha of industrial / distribution land, plus a further 80,180 sqm of office floorspace (around 20 ha, if a 40% plot ratio is applied). This reflects the consistently high levels of delivery Newark & Sherwood has experienced over the past 11 years or more, which does not even take into account the 19.05 ha Dixons Mastercare site (which was delivered before the start of the current monitoring period in 2006/07). The econometric and labour supply models suggest a lower level of need, of up to 55.69 ha based on the Regeneration Scenario (again converting the office floorspace to land). It is for the Council to take a view as to the extent to which the maintenance of the current very high rates of completions (and a loss replacement of 18 ha) is a desirable policy outcome.

Even so, the District already appears to have a substantial supply of committed and allocated employment land that would appear to meet the need in full.

- 10.22 Ultimately, the selection of the final employment land requirement will depend upon the preferred level of employment growth for the 8 districts, the scale of loss replacement, and the extent to which Officers consider that this aligns with the councils' growth aspirations, including the need to reduce net out commuting and balancing economic considerations with housing needs. The level of employment growth will be based upon the identification of policy aspirations relating to the promotion of key sectors in accordance with the economic and spatial vision for the area.
- 10.23 This demand/supply analysis assumes that each authority's undeveloped employment allocations come forward in their entirety for employment development over the plan period, and that all extant employment land planning permissions will be developed. Any significant deviation from this broad assumption would have an impact upon the overall balance, for example by tightening the existing surplus of employment space or resulting in an increase in the shortfall under some of the more optimistic scenarios.
- 10.24 In addition, stakeholders commented that economic growth across Greater Nottingham has been limited by **lack of available large-scale strategic distribution sites** over the past decade and that studies forecasting need based purely on past trends will significantly underestimate the scale of demand. Agents were confident that there is capacity in the market for a further one, or even two, very large regional distribution centres near to these key M1 junctions and that at current levels of demand, two such schemes, if made available, would be at capacity within a decade.
- 10.25 It is recommended that the District Councils (potentially in collaboration with adjoining districts along the M1 Corridor) may wish to commission **a further strategic study to quantify the likely extent of national/regional B8 logistics need across the Core/Outer HMAs**. This future study should seek to quantify the scale of strategic B8 required and potentially identify sites where this need should be allocated. Our view would be that the focus of this future study should be on the M1 Corridor and A-roads near the motorway junctions where this study demonstrates demand is especially high at present.
- 10.26 In terms of planning positively for Strategic B8, the Nottingham Core/Outer HMA districts must ensure that there is sufficient flexibility in the allocations in terms of B2/B8 functionality, as there may be an element of assembly or manufacture alongside storage/distribution in the same unit. Similarly, operators will require a high degree of flexibility on car parking, charging points for delivery vehicles, the scale of 'ancillary' office floorspace available and access to 'last mile' distribution depots nearby. All of these factors are key drivers in shaping market attractiveness to national operators/investors.

Qualitative Considerations

- 10.27 A number of key themes emerged throughout the stakeholder discussions and the results of the business survey, including the rapidly rising demand for distribution floorspace, the need for an increased supply of Class A office space (particularly within Nottingham City) and the opportunities for smaller urban centres as working patterns evolve and capacity becomes squeezed within the more traditional town centre office markets.
- 10.28 The rapid shifts in the demand for distribution floorspace dominated conversations with commercial agents, as, in terms of trends, the industry was said to have progressed 5 years within the past 12 months. Whilst this has essentially been an expedited continuation of past trends, it has been accelerated by essential requirements of the pandemic and associated national lockdowns. In this regard, agents were keen to stress the sheer scale of demand that exists within the market from a range of potential occupiers, from national scale to final mile distribution facilities. The M1 corridor along the western arc of Nottingham was identified as the primary area of demand, with distribution floorspace located around any junction from J28 in Ashfield running south to J24, highlighted as a key market ask from potential occupiers. To illustrate the scale of latent demand, one agent predicted that a further two developments on the scale of the East Midlands Gateway located at any major M1 junction within Greater Nottinghamshire may not be enough to satiate demand over the next decade. To underline the urgency, it was emphasised that the requirement is now and if not fulfilled, may go elsewhere.
- 10.29 Locations such as business parks closer to urban areas with good access to the M1 were identified as secondary potential locations for development, as skills availability becomes an increasingly important factor for occupiers due to the rapidly changing labour requirements within the industry. Demand for distribution floorspace along the A1 corridor is more subdued, although demand still exists here for smaller final-mile distribution units of which there remains a lack of supply.
- 10.30 Property agents highlighted that whilst the nature of this demand has certainly been accelerated by recent market conditions, opportunities have been missed within Greater Nottingham due to a lack of available employment sites over at least the past decade. In this regard it was considered that projecting forward past trends would not adequately capture the need for sites that presently exists within the market.
- 10.31 Large scale distribution demand was said to be split between national distribution centres ranging from 500,000 sq ft up to a million sq ft and smaller regional and last-mile distribution units in the range of 200,000 sq ft or less. The preferred approach from both developers and occupiers is to expand such industrial parks at key transport intersections wherever possible to avoid overloading the road network in urban locations and to allow for business expansion without locating away from existing workforces. To cater for the larger-scale side of the market, developers would like to see larger units of 1 million sq ft+ that have flexibility to be divided into smaller units, although

there is awareness of the challenges this presents to councils in allocating such large sites in constrained areas.

10.32 In terms of office floorspace requirements, discussions focussed particularly around the lack of Grade A office space in Nottingham City, and how office requirements are changing generally. Whilst there is considerable uncertainty at present about the extent to which homeworking, enforced by the lockdowns, will become the norm in future years, agents still suggested that the market was likely to recover strongly and that expanding businesses are being forced to look for office space in out-of-centre locations due to the lack of space in the City, which remains the most-in demand location. At the same time, there is increasing demand for smaller, modern and more flexible office space that can accommodate 30-50 employees from businesses in innovative sectors such as biotech and software. Property agents reported increasing numbers of enquiries from hi-tech businesses looking to relocate from London and the Greater South East due to rising rents and narrowing labour supply, presenting a real opportunity if adequate supply can be made available. This trend is already manifesting itself somewhat in the conversion of older and larger office units into smaller modernised and flexible spaces for collaborative working. Alongside this, units for innovative businesses in enterprise parks and innovation hubs continue to be in high demand across the two HMAs.

10.33 Overall, stakeholders were generally of the view that the trends emerging from the pandemic may not be as pronounced as some expect regarding a drop off in demand for office space. That said, the business survey did indicate that around a quarter of respondents expect to increase levels of remote working and explore greater flexibility in working patterns for their staff over the long term, with just under half expecting to move premises in the next 5 years. This is likely to increase the demand for good quality, office space on flexible terms near to town centres in the outer districts as offices play an increased role as gathering points rather than being needed for the whole workforce 5 days a week. In this sense, demand for smaller and more flexible units close to transport links and town centre amenities may increase across Greater Nottingham.

Implications of the new E Class on Employment Land

10.34 From 1st September 2020, the Government's changes to the Use Class Order (UCO) came into effect, with Use Classes A, B1 and D being revoked, and a new Use Class 'E' (Commercial, Business and Service) being introduced as well as Use Class F1 (Learning and Non-Residential Institutions) and F2 (Local Community).

10.35 This essentially means that shops, financial and professional services (not medical), cafés or restaurants, offices (other than a use within Class A2), research and development of products or processes and for any industrial purposes (which can be carried out in any residential area without causing detriment to the amenity of the area) fall under the new 'E' Use Class. This will allow E Use Class premises to change use without needing planning permission.

- 10.36 The Government has stated that the main driver of these changes has been the need to enable the repurposing of buildings in town centres and on high streets in order to revitalise town and city centres.
- 10.37 It is expected that the new regulations will lead to an increase in premises changing use. While this could help to bring vacant units back into use, it also poses a risk that instead of creating diversity, less profitable or valuable uses may be priced out of town centres.
- 10.38 There is also a risk of impacting prime frontages in the Nottingham Core/Outer HMAs' town centres. Should a large retail unit be repurposed for office use, then there is likely to be a break in the prime frontage, potentially having a negative impact on the attractiveness and coherence of town centres. There is also a risk of retailers being drawn out of the town centres to occupy vacant premises on business parks or industrial areas, thus competing with the town centre.
- 10.39 From a landlord's perspective, the new E Use Class represents a greater opportunity to secure the most valuable use for their assets. Premises falling into the E Use Class will benefit from being marketed across a number of sectors, widening the pool of potential tenants, which may give rise to some uplift in land values.
- 10.40 Landlords will likely be assessing whether the current uses of their assets maximise the possible rents that can be achieved through the increased flexibility. This may in turn drive up rents, potentially outpricing smaller businesses.
- 10.41 In practical terms, these changes to the new Use Classes Order are likely to mean that it is harder for councils to prevent future losses of employment land, particularly office and light industry. Whilst this extra flexibility may well be beneficial to the development industry and help them to respond more rapidly and effectively to the current economic uncertainty, it also means that the 8 councils in the Nottingham Core/Outer HMAs cannot take for granted that their former B1a/b and B1c sites can be protected into the longer term with a simple policy designation. For this reason, it may be necessary for the councils to factor in an additional level of flexibility to their land supply on top of the current need identified to offset any additional unforeseen losses that may occur as a result of an increasingly de-regulated planning system. Equally, they will wish to consider how key employment sites may be protected. We turn to this matter in the following section.

Managing pressures from other non-employment uses

- 10.42 The strategic site assessment process conducted as part of this study has indicated that the 8 districts have a portfolio of employment sites that are generally performing well and appear to have high occupancy levels and meeting local business needs. With a handful of exceptions, this study has not identified any specific evidence to suggest that existing employment sites have no reasonable prospect of continuing to be used for employment uses over the local plan period(s), although it is suggested that this should be reviewed on a regular basis to take into account any changing factors over the plan period.

This may not be the case for the second-stage smaller employment site assessment which will be conducted by the individual districts and which may well focus on much smaller and more marginal employment sites.

- 10.43 In this context, this section considers the increasing demand from non-employment uses within the area's employment designations, based on a desktop analysis and drawing on latest market intelligence.
- 10.44 It is evident that over the last few years there have been an increasing number of planning applications received in relation to change of employment use classes to C3 uses due to office to residential Permitted Development Rights, especially in Nottingham City. This pressure may increase due to the introduction of Class E. There has also been an increasing encroachment of Sui Generis or other non-employment uses on many of the larger strategic employment sites in the study area. Whilst much of this is to be welcomed, as the modest introduction of pubs, gyms, shops and other similar uses can ensure that the Business Park / Industrial Estate in question increases its vibrancy and provides workers with opportunities to socialise with co-workers or spend their lunch hour out of the working environment, there is a risk that if the employment element is watered down too much it can make the site less attractive to some occupiers, and may even begin to affect the operational viability of certain 'bad neighbour' uses.
- 10.45 In the context of the NPPF requirement that "*planning policies should as part of plan updates, reallocate the land for a more deliverable use that can help to address identified needs (or, if appropriate, deallocate a site which is undeveloped*" [Paragraph 120, point (a)], the councils should consider re-visiting and potentially changing existing boundaries of some of the larger employment areas such as NCC12 Bar Lane/Radford Road, NCC14 Nottingham Business Park and NCC21 New Basford Industrial Estate, subject to further monitoring on the change of uses. However, monitoring such changes will be more difficult in the future as such changes will no longer require planning permission where they fall within the same Use Class.
- 10.46 An alternative approach could include defining a core business area within some employment areas where only E(g)/B2/B8 class uses will be permitted, taking account of the current pattern of development, key frontages and where scope for improvements (e.g. public realm, linkages) have been identified. A more flexible approach could remain for other parts of these sites where a wider range of uses (within E Class) are permitted subject to criteria, so the overall employment functioning of the area is not undermined. This should be revisited later in 2021 once Government policy on Permitted Development Rights for Class E-Uses is further clarified to ensure it is compatible with national policy.
- 10.47 In general, there would appear to be a reasonable basis for maintaining an employment land protection policy for key sites in the 8 districts' emerging local plans in line with the allocations already set out in planning policy. This would ensure that Greater Nottingham can retain its business base and sector strengths, particularly in view of the overall constraints to bringing forward additional employment land due to the tightly defined Green Belt boundaries surrounding Broxtowe, Erewash, Gedling and, to a lesser extent, Rushcliffe and Ashfield.

10.48 It is recommended that a subsequent piece of work should be undertaken by the councils to provide to provide appropriate guidance on protecting employment sites in the districts, particularly, in terms of criteria that should be met when assessing planning applications involving the loss of former employment floorspace. Subject to any future government national planning guidance on this topic, this should remain a core consideration of the decision-making process for employment sites in Greater Nottingham as the new style local plans emerge.

10.49 To protect key employment sites from undesirable redevelopment or from inappropriate conversion for non-employment purposes, the councils may wish to consider adopting a local plan 'exceptions' policy which sets out criteria against which such proposals can be evaluated. These criteria might include the following and would relate to land currently in use, or was last used, for employment purposes and not allocated in the local plan wholly for non-employment uses:

- It should be demonstrated that the employment site (or part thereof) is no longer suitable for employment use, bearing in mind the physical characteristics, access arrangements and/or relationship to neighbouring land-uses, and there is evidence of active and substantial marketing of the site for employment use over the previous two years which has not been successful; or
- It would not be financially viable to re-use or redevelop the land or buildings in whole, or in part, for employment purposes; or
- The non-employment development proposal would be used for purposes which would be ancillary to, and will support, the operations of a primary employment use on the land; or
- The non-employment development would generate significant employment gains which are of sufficient community benefit to justify the loss of the employment land.
- In addition, it should be demonstrated that the potential of the site to contribute to the employment land requirements of the district over the plan period is not significant.

10.50 Specifically, it is evident that there has been a significant loss of employment space, particularly in Nottingham City, mainly through the 'Prior Approvals' procedure from office to residential uses. In this regard, there could be scope for the City Council to consider applying an Article 4 Direction to increase its ability to protect key office sites in the City, in particular, strategically important office clusters in, and around, the Canal, Creative, Castle and Royal Quarters of the City Centre which, collectively, will provide the key focus for regeneration and economic renewal in the City over the coming years. Please note that this policy advice may change depending on the outcomes of the current Government consultation on changes to the NPPF relating to the use of Article 4 directions, given that the current intention appears to be to limit their usage for this purpose, unless considered essential to avoid wholly unacceptable land-use impacts.

Identification of policies to support a range of employment uses

- 10.51 To meet the future requirements for office and industrial/warehousing floorspace across the Nottingham Core/Outer HMAs, it will be necessary for each of the 8 Councils to make choices about which employment sites to protect or allocate for employment development or which to bring forward as mixed-use schemes either in part or whole. Whilst Lichfields has made recommendations concerning the retention (or otherwise) of 133 existing, allocated or potential employment sites across the study area, the Councils will ultimately need to make policy judgements on which sites to retain/protect for employment use. These policy judgements need to consider:
- the local benefits of key employment growth sectors and the need to sustain a diversified and resilient economy that is able to capitalise on economic growth opportunities as they arise;
 - the economic and market outcomes that would come to the fore if particular sectors become displaced from the economy, or are otherwise constrained from expanding in the area;
 - the need to promote growth in high value employment roles/jobs that require a skilled workforce in the Nottingham Core/Outer HMAs and that meet the aspirations of resident workers, reducing the need to commute to Derby, North West Leicestershire and beyond; and,
 - the requirement to set targets for delivery of new employment space particularly on strategic sites along the M1 Corridor west of Nottingham to provide clarity and certainty for developers, which will require a practical assessment of what the market can deliver at any point in time.
- 10.52 For mixed-use allocations, masterplans and delivery strategies should be developed to help ensure that the indicative quantum of employment floorspace/land suggested is delivered in practice over the plan period. Without this additional clarity, these sites could present a higher risk in terms of their ability to meet business needs in the Nottingham Core/Outer HMAs.
- 10.53 In order to ensure a flexible and responsive policy framework for the study area, it will be necessary to not just concentrate on meeting the forecast quantitative requirements for office and industrial space in the area, which will fluctuate over time, but to reflect on the opportunities and risks that flow from particular policy approaches. This could include how the delivery of office/industrial employment land can be prioritised in particular areas and for particular uses, or how scope can be created to deliver inward investment opportunities for the Nottingham Core/Outer HMAs, in particular by drawing and capitalising upon the growth opportunities provided by the M1 Corridor and the D2N2 LEP generated by positive strategic planning policies and promotional activities.
- 10.54 In this regard, Greater Nottingham has a number of business sectors and clusters that are performing well with extremely successful internationally recognised companies operating in and around the County. The Councils' strategy for these key sectors is to work with companies investing in these enterprises and to support their growth in the competitive national and

international economy. As per the discussion set out in the Regeneration modelling Scenario in Section 8.0, the latest version of the D2N2 SEP, '*D2N2 – the Spark in the UK's Growth Engine Strategic Economic Plan - 2019-2030*' moves away from job creation as a specific target, and instead shifts towards tackling the productivity gap in order that Nottinghamshire and Derbyshire remain competitive business locations and to deliver long term prosperity.

10.55 To do this, the D2N2 LEP's SEP identifies 11 priority sectors that are important to the D2N2 economy for different reasons and will need different interventions in order to effectively contribute to productivity growth. These are split into 2 categories, Science and Innovation Core Sectors and Opportunity Sectors. These sectors have been identified by D2N2 according to their degree of specialisation, tradeable 'clustering', concentration of employment or prospects for growth. It will be vital to ensure that companies operating in these key sectors find the locations and expansion opportunities that they can invest in. In this regard, providing sufficient employment land to accommodate the following sectors will be key:

- Transport Equipment Manufacturing
- Food & Drink Manufacturing;
- Life Sciences;
- Creative & Digital;
- Logistics & E-Commerce;
- Construction; and
- Professional and Business Services.

Measures to facilitate development across Greater Nottingham

10.56 The future growth scenarios considered in this study indicate the broad scale and type of growth associated with different approaches to modelling economic development needs and requirements for the Nottingham Core/Outer HMAs over the period 2018-2038. To varying degrees, these scenarios reflect both the indigenous growth needs in Nottingham Core/Outer HMAs as well as a degree of footloose demand that operates within a wider sub-regional market. As set out below, it has not identified the potentially substantial strategic level B8 distribution that meets needs at a regional and even national level, which is poorly reflected in past take-up rates across the 8 authorities (with the partial exception of Ashfield District) due, in part, to a lack of supply in recent years and the rapidly changing market for e-commerce, in particular.

10.57 In the context of the NPPF and PPG, the policy approach adopted by the 8 Councils should aim to positively plan to support the economic development needs of the Nottingham Core/Outer HMAs so that the local economy is not unduly constrained over the plan period, but also recognises the issues around land supply and competing pressures on available development sites.

10.58 In order to ensure a flexible and responsive policy framework for the County, it will be necessary to not just concentrate on meeting the forecast quantitative requirements for office, industrial and warehousing space in the Nottingham

Core/Outer HMAs, which will fluctuate over time, but to reflect on the opportunities and risks that flow from particular policy approaches. This could include how the delivery of business space can be prioritised in particular areas and for particular uses, or how scope can be created to deliver inward investment opportunities for Greater Nottingham. For example, by drawing and capitalising upon the growth opportunities provided by the M1 Corridor and the activities of the D2N2 LEP.

- 10.59 As part of this study Lichfields has assessed 133 of the Nottingham Core/Outer HMAs key strategic sites, and made recommendations on whether each should be allocated, protected for employment use or released from the portfolio. Due to the importance of most of these sites, the vast majority are recommended to be retained, albeit with some changes to many of the boundaries to reflect the changing market realities and also the land uses on some of these sites. These 133 sites only represent a proportion of the overall employment land portfolio of each district, and there are many more smaller sites that have not been assessed for their future suitability/deliverability for ongoing employment use. We understand that the Councils will undertake this second stage assessment separately, and guidance has been provided separately to Officers regarding the assessment criterion to ensure consistency with this ELNS.
- 10.60 The PPG requires LPAs to regularly review short-term changes in economic market conditions and given the considerable state of flux we are operating under at present due to the Pandemic and the early stages of Brexit, it will be important that the 8 councils closely monitor the pace, scale and location of commercial floorspace change, requirements and delivery over time, and consider this within the context of the demand-side evidence presented within this study. This process would benefit from closely working with local business sectors to understand their aspirations for new employment floorspace.
- 10.61 In this context, it is important that planning for office, industrial, retail and leisure employment growth in the Nottingham Core/Outer HMAs is balanced against pressures from other land uses. These uses compete with a wide range of other commercial uses (which fall outside the remit of this study), some of which may also generate benefits to Greater Nottingham's economy or have identified needs that the NPPF indicates should also be duly supported. As noted above, the new E Class order also presents some challenges in this respect as it may be harder to prevent the loss of office and light industrial floorspace, both of which are seen as being key to driving economic growth in the County over the coming years.
- 10.62 Alongside provision of new supply, upgrading and renewal of the councils' ageing existing stock of office accommodation will also be important. Nottingham City in particular still has a high proportion of older office floorspace despite the loss of many units to residential through Permitted Development rights. The Core HMA districts generally also have a higher proportion of older industrial and warehousing stock, certainly in comparison to the 3 Outer HMA districts which have generally seen higher levels of development in recent years than the 5 Core HMA districts. A comprehensive plan for upgrading and enhancing these older units and estates will not only ensure that this space remains attractive to the market but may also provide the

opportunity to create some additional supply. This may comprise redevelopment, but qualitative improvements can also be delivered through refurbishment of existing inter-war buildings (to an extent).

- 10.63 Barriers to the redevelopment of industrial premises in the Core/Outer HMA include weaker viability on sites that are not located in prime locations near to the wider Motorway network west of Nottingham, and away from the A1 Trunk Road in the eastern part of the study area. A greater proportion of lower quality premises in the more isolated parts of the study area may mean that standards provided by landlords are often lower than is achieved in stronger market areas to the west. Better utilisation of the stock on such sites could be achieved either through gradual redevelopment of individual plots (e.g. replacing a large older unit with development of modern small units, particularly move on workspace for which there is good demand), or the sub-division of larger units.
- 10.64 Based on experience elsewhere, qualitative improvements on the larger estates could also include the stripping and repainting of older industrial units, and making environmental, security and traffic management improvements. Similar processes of gradual upgrading could be encouraged in larger industrial areas to ensure they can make a positive contribution to meeting some of Greater Nottingham's future growth requirements.
- 10.65 There may also be some potential to explore different funding sources to enable SMEs to upgrade premises or develop new premises if the market does not deliver these improvements. This could be through either gap funding assistance or de-risking improvements through up-front finance. This could include a number of forms of direct Council or D2N2 LEP financial support, such as a Business Improvement Grant, and direct lending to small firms and/or mortgage support. Such measures may be harder to fund in the current economic climate (given the considerable uncertainty regarding the pandemic and Brexit) but could be worthwhile future actions.
- 10.66 It may be appropriate to explore opportunities to de-risk planning issues for certain types of development, in a way that is appropriate to the site context. This could include, for example, Local Development Orders [LDOs], design codes, or other forms of planning guidance to provide greater certainty on the types of development that will be supported by the 8 Councils.
- 10.67 LDOs allow Councils to identify specific areas or sites where, having consulted up on and adopted a LDO, express planning permission is not required for certain types of development defined in the Order. Examples applying to industrial estates could include alterations or certain types of extensions to premises, construction of new employment premises within specified floorspace limits, and/or certain types of change of use. In some situations, this approach could provide benefits to occupiers or developers through greater flexibility, faster planning procedures, certainty of outcomes and reduced costs.
- 10.68 The market alone is unlikely to deliver these improvements. Encouragement for owners and developers may be necessary, and could be aided by a range of planning and economic development interventions including:

- 1 An emerging Local Plan policy encouraging such forms of upgrading, although this will only work in combination with other actions;
- 2 Continued and stronger Local Plan policy protection for certain industrial sites as discussed at paragraph 10.52 above (reducing the potential for residential 'hope value' pricing out development);
- 3 Local initiatives to publicise to local companies, case studies of successful upgrading of business premises, including costs, recommended local contractors and rental or other benefits achieved;
- 4 Encouragement of mixed-use developments to help facilitate and cross-subsidise the creation of office/industrial premises; and
- 5 Nottingham Core/Outer HMA Council EDOs engaging with owners on the upgrading of their premises, providing advice on grants/loans that may be available, where appropriate.

Glossary

Base Year	Starting year for assessment (in this case, 2018).
BRES	The Business Register and Employment Survey [BRES] is the official source of employee and employment estimates by detailed geography and industry.
D2N2 Local Enterprise Partnership	There are 38 Local Enterprise Partnerships [LEPs] across England. They are local business led partnerships between local authorities and businesses and play a central role in determining local economic priorities and undertaking activities to drive economic growth and the creation of local jobs. The D2N2 LEP is one of the largest in England and supports economic growth across Derby, Derbyshire, Nottingham and Nottinghamshire.
Economic Activity Rate	The % of population (both employed and unemployed) that constitutes the manpower supply of the labour market.
Employed Population	Total number of employed population resident within a particular area.
Employee Jobs	Excludes self-employed jobs, HM Forces and Government Supported Trainees. The estimates also exclude employee jobs in farm agriculture.
Employment Densities	Employment density refers to the average floorspace per person in an occupied building, and is therefore a measure of how much space each person occupies within the workplace.
Functional Economic Market Area [FEMA]	Functional Economic Market Area, or the spatial level at which local economies and markets actually operate. FEMAs reflect the practical way in which labour, housing, property and consumer markets function across administrative boundaries and the recognition that economic markets and flows operate across a much wider geography.
Full Time Equivalents [FTEs]	A unit of measurement whereby an FTE of 1.0 means that the person employed is equivalent to a full-time worker, while an FTE of 0.5 signals that the worker is employed on a part-time basis.
Gross External Area	Broadly speaking the whole area of a building taking each floor into account and including the perimeter wall thickness and external projections.
Gross Internal Area	In general terms the whole enclosed area of a building within the external walls, taking each floor into account but excluding the thickness of the external walls.
GVA	Gross Value Added [GVA] is a measure in economics of the value of goods and services produced in an area, industry or sector of an economy.
IMD 2019	The English Indices of Deprivation 2019, focussing on the national and sub-national patterns of multiple deprivation.
Job Density	Jobs density is defined as the number of jobs in an area divided by the resident population aged 16-64 in that area.

Knowledge-based industries	Those industries which are relatively intensive in their inputs of technology and/or human capital.
Location Quotients	Location Quotients measure the proportion of employment in an industry at the local authority level relative to the regional average.
National Planning Policy Framework [The Framework]	First Published in March 2012, with the most recent comprehensive iteration dating to February 2019, the National Planning Policy Framework sets out the Government's planning policies for England and how these are expected to be applied.
Net Internal Area	The usable area within a building measured to the face of the internal finish of perimeter or party walls ignoring skirting boards and taking each floor into account. This excludes toilets, lobbies, cleaners' cupboards, lifts, stairwells, corridors, circulation areas and internal structures such as walls and pillars.
Office for Budget Responsibility [OBR]	The OBR is a non-departmental public body funded by the UK Treasury, that the UK government established to provide independent economic forecasts and independent analysis of the public finances.
Planning Practice Guidance [PPG]	On 6 th March 2014 CLG launched the Planning Practice Guidance [PPG] web-based resource. This website brings together many areas of English planning guidance into a new format, linked to the Framework.
Resident Labour Supply	The supply of working age population resident within a particular area.
Resident Workforce Population	All usual residents aged 16 and over in employment
Plot Ratios	Plot ratios measure the total area of each floor (gross) of the building(s) (including plant), and relate this to the area of the site, excluding roads, pavements, access roads to backland sites and any land included in the site. For example, a two storey building covering half the site would have a plot ratio of 1:1, as would a 5-storey building covering one fifth of the site.
Total Workforce Jobs	Total number of people in employment, regardless of whether it is a full/part time split (versus full time equivalent FTE jobs).
Working Age Population	The population of a particular area aged 15 to 64.
Workplace Labour Supply	The supply of working age population working within a particular area (i.e. workplace-based jobs).
Workplace Population	The population whose usual place of work is in that local authority, including both individuals who live and work in the local authority and individuals who work in the local authority but commute from a home elsewhere within England or Wales.

Appendix 1 Discussion on the Scale of Loss Replacement

Introduction

There is usually a need to ensure a reasonable allowance that provides for some flexibility but avoids over-provision of land. The 8 councils may wish to make an allowance for the replacement of future losses of employment space that may be developed for other (non-office/industrial) uses over the plan period. Where such an allowance is factored into future employment space needs, it seeks to ensure that sufficient space is re-provided to account for employment space that could be lost moving forwards. It is intended, therefore, to provide some protection against the erosion of employment space over the plan period. This is a widely accepted approach in planning for future employment land needs.

Not all losses need necessarily to be replaced as some will reflect restructuring in the local economy as less space may be needed in some sectors in future. However, some replacement is needed to refresh the quality of the stock, provide market choice and to avoid the employment land supply continually declining. This would be on the basis that the stock of employment land in Greater Nottingham contains some older sites less likely to meet future needs and is of a scale that reflects past industrial patterns, rather than the amounts of land needed in future.

However, against this argument is the likelihood that further sites may be lost by 2038, and these will represent losses to the overall land portfolio, reducing choice within the market.

Furthermore, as set out in detail in the commercial market analysis in Section 5.0, there is a perception amongst the development community that the land supply has been severely constrained in recent years across the sub-region, and given the changes to the Use Class Order and the seismic shift in the logistics market resulting from the surge in demand for e-commerce during the lockdowns, there is a need to ensure a reasonable allowance that provides for some flexibility, but avoids the over-provision of land.

Determining an appropriate scale of re-provision is a judgement for the councils to make to align with their particular economic growth and strategic policy considerations. Nevertheless, there are a number of data sources that can be scrutinised to provide some guidance as to what an appropriate level of re-provision might be. These include identifying how much employment land is in the pipeline to be lost to alternative uses (from reviewing extant planning applications and SHLAAs); reviewing past trends and assessing whether this is likely to continue for the foreseeable future; and a 'rule of thumb' approach looking at the size of the local property market and the extent to which there needs to be an element of replacement of a certain proportion of the current commercial/industrial stock to ensure that portfolio does not become increasingly obsolete.

Pipeline Losses

Taking the first of these approaches involves reviewing pipeline permissions/employment sites earmarked to be lost to alternative uses. Alongside sites with extant planning permission, there are numerous existing/former employment sites identified in the councils' most recent

SHLAAs that are identified as being developable for housing over the next 15 years or so. Commentary is provided for each of the districts below.

Core HMA

Broxtowe

According to Broxtowe Borough Council Officers, SHLAA information is less relevant for Broxtowe Borough as it primarily relates to undeveloped greenfield sites rather than existing office/industrial/warehousing sites. For this reason, no existing employment sites were identified by the Council as having the potential to be lost over the foreseeable future.

Erewash

Erewash Borough Council's 2019 SHLAA Site Assessment identifies 25 existing employment locations which are active, and where these are likely to be lost to residential development over the coming years. These sites are ones where EBC is aware of the landowners' desire to relocate or where businesses have ceased to operate, and which would potentially be suitable for residential uses. These are broken down as follows:

- 3 deliverable existing employment sites (0-5 years) totalling 2.93 ha;
- 7 developable sites (5-10 years) totalling 51.65 ha;
- 8 developable sites (11-15 years) totalling 4.39 ha; and
- 7 other existing employment sites that are suitable for redevelopment for residential use beyond 15 years, totalling 8.21 ha.

These 25 existing employment sites would potentially result in the **loss of 67.18 ha** of employment land from the Council's portfolio. Of this total, the bulk relates to just one site – the 44.7 ha West Hallam Industrial Park and Storage Depot, which is projected to be lost in 6-10 years' time. This is earmarked as having the potential to accommodate up to 1,000 dwellings. It forms one of the Council's proposed housing growth allocation sites it has consulted on as part of its Regulation 18 Growth Options consultation (January 2020) which would replace the 2014 adopted Erewash Core Strategy.

This level of loss would equate to **3.93 ha per annum over the next 15 years**.

Gedling

The 2019 SHLAA for Gedling Borough identified four significant existing employment sites which could be suitable for housing redevelopment. The Council has anticipated and accepted that these sites in planning policy terms are acceptable for redevelopment for housing in principle and none were considered as being of sufficient quality to retain as employment land. These are:

- 6/7 - Meadow Road (Carlton) recorded as industrial land **1.18 ha** (with outline planning permission for residential subject to S106);

- 6/20 - Bestwood Business Park **6.01 ha** and currently still occupied by businesses (allocated for housing in our Local Plan although outline planning permission for residential has elapsed it is understood the owners are still seeking to redevelop for residential);
- 6/477 – Daybrook Laundry (Arnold) **0.93 ha** (allocated for housing in our Local Plan); and,
- 6/479 – Metallifacire (Arnold) **1.33 ha** (full planning permission for 72 homes and allocated in the Local Plan for housing).

These four sites total around 9.45 ha, although only one is currently occupied, whilst the others have been vacant for a considerable period. In this context it would not be necessary to factor in a complete replacement in quantitative terms for these three other sites but nonetheless they would result in a loss of the existing industrial stock and would be recorded as such in future AMRs. Council Officers also identified the possibility of another employment site being redeveloped for housing at Catton Road industrial estate which is not in the SHLAA and is approximately **1 ha** in size.

Assuming they are redeveloped over the plan period 2018 to 2038 then this would result in losses of 10.45 ha, or around **0.52 ha per annum**.

Nottingham City

NCC Officers have reviewed the latest iteration of the City’s SHLAA to inform this ELNS. Based on the existing employment sites that are considered suitable, deliverable and developable for residential development to 2038, Officers calculated losses equal to **3,000 sqm per annum for offices, and 7,700 sqm per annum for industrial / warehousing floorspace (1.925 ha)** going forward.

Rushcliffe Borough

RBC Officers have reviewed the latest Rushcliffe SHLAA to inform this ELNS. They confirmed that it does not contain any additional sites within it over and above those that have planning permission for redevelopment to residential use. The Council has had an initial approach in relation to Wheatcroft Business Park, (Edwalton) but this has yet to be assessed in the SHLAA and would be likely to only amount to the loss of a small amount of office space in any case.

Outer HMA

Ashfield District

Council Officers confirmed that the most recent SHELAA identified almost no existing employment sites/existing employment permissions which could be lost to residential use in future. The exception relates to the Rolls Royce site at Hucknall. A number of buildings at Rolls Royce have been demolished and under the SHELAA and a current planning application, are proposed for residential development to be integrated with the mixed-use development for which planning permission has been granted (V/2013/0123).

Harrier Park (at Rolls Royce, Hucknall) has an existing planning permission granted (V/2013/0123) for a mixed-use development including employment land. The Business Park in the permission, comprises approximately 27 ha (gross) in size (including access and landscaping). A submission to the SHELAA and a current planning application has proposed that part of Harrier Park comprising 4.91 ha is utilised for residential purposes.

Two existing employment allocations in the Ashfield Local Plan Review are greenfield sites, which have not (to date) been developed. These are:

- Land south of A611/Annesley Road, Hucknall (1.48 ha) where planning permission has been granted for residential development in the past.
- Land off Watnall Road, Hucknall (0.6 ha) where a planning application has been submitted incorporating the allocation for retail purposes.

The following existing employment sites have permission or have an application pending for permission for an alternative use:

Table A1.3 Existing Employment Sites in Ashfield District with extant permission / permission pending for alternative uses

Application Reference No.	Site Name	Status	Proposed Use	Size of site	Commentary
V/2018/0221	Land off Mansfield Road, Sutton in Ashfield	Existing employment site	Retail	1.0371 ha	Proposed for use as a Lidl was subject to a legal change in relation to the planning permission and the application is subject to reconsideration – Pending.
V/2015/0264	Quantum Clothing Group Ltd North Street, Sutton in Ashfield	Existing employment site	Housing	2.5 ha	Permission was granted at appeal on 22/01/2016 so that the permission has now expired. However, former factory has been demolished.
V/2014/0530	Former Reticel Building (demolished), Southwell Lane, Kirkby-in-Ashfield	Existing employment site	Housing	2.0042 ha	A reserve matters application has been submitted v/2018/0333, - Pending.
V/2018/0550	Sidings Road, Kirkby-in-Ashfield.	Existing employment site	Housing	2.5 ha	Outline permission has been granted for residential development (V/2014/0661 decision date 29/5/2015). The outline permission has expired but a new application has been submitted v/2018/0550, - pending. Site area includes existing employment and open space. Employment site approx. 2.5 ha.
V/2014/0530	Land at Watnall Road/Daniels Way, Hucknall	Existing employment use and allocation	Housing	1.1 ha	Outline permission for residential development with reserved matters applications
V/2020/0553	Land at Rolls Royce (Harrier park), Hucknall	Existing employment use.	Housing	3.98 ha	Planning permission submitted for residential development - Pending

Source: ADC (2021): Employment Land Monitoring Report 2020 / ADC Officers

Application Reference No.	Site Name	Status	Proposed Use	Size of site	Commentary
V/2015/0629	Land south of A611/Annesley Road, Hucknall.	Existing employment allocation	Housing	1.48 ha	Planning permission has been granted for residential development.
V/2020/0306	Land off Watnall Road, Hucknall	Existing employment allocation	Retail	0.6 ha	Planning application submitted – pending for Lidl. Application includes an employment allocation 0.6 ha -

Pending

Table A1.4 Existing Employment Allocations in Ashfield District with extant permission / permission pending for alternative uses

Source: ADC (2021): Employment Land Monitoring Report 2020 / ADC Officers

A number of these sites are pending as no decision has been made at this time as to whether permission will be granted or not. In total, the Council considers that as a worst-case scenario **13.12 ha** of existing employment land could be lost to non-employment uses (noting that this does not prejudice the outcome of the decisions).

Mansfield District

A Housing and Economic Land Availability Assessment [HELAA] was published by the Council in 2017. The HELAA found that the estimated industrial land supply in Mansfield was around 34 ha, and of this, almost 20 ha are on sites that had planning permission. The estimated office space supply comprised over 87,000 sqm, and of this, almost 65,000 sqm of the office supply had planning permission. The HELAA process also identified about 31,000 sqm of retail floorspace, almost 27,000 sqm of this is on sites that had not been consented. The document **does not identify any existing employment sites that would be suitable for housing** or other non-B-Class uses.

The Mansfield Employment Land Monitoring Report 2019 indicates that in 2018/19, the amount of employment floorspace approved for change of use was 1,302 sqm of office and 3.89 ha of industrial land (3.5 ha B2, 0.39 ha B8):

Table A1.5 Land / Floorspace with permission for Alternative Uses (ha) – 01/04/2018-31/03/2019

Planning Reference	Expiry Date	Site Name	Employment Use (Current)	New Use Class	Planned Loss
2016/0364/NT	15/08/21	108 Chesterfield Road North, Mansfield	B1a	C3	96.3 sqm
2017/0754/FUL	09/01/23	The Old Town Hall, Market Place, Mansfield	B1a	A1	80 sqm
2017/0568/RES (2012/0350/ST)	04/07/20	Land between 63 and 91 Berry Hill Lane (Mansfield Sand Company Limited), Sandhurst Avenue	B2	C3	3.5 ha
2018/0732/COU	16/01/19	39 Stockwell Gate, Mansfield	B1a	A1 / A2 / A3 / A5	200 sqm
2018/0182/COU	11/05/23	Unit C4 St Crispins Court, Stockwell Gate, Mansfield	B1a	D2	260 sqm
2018/0083/PNS CUO	20/03/21	Hill House, Commercial Gate, Mansfield	B1a	C3	665.8 sqm
2019/0035/COU	19/03/22	42 Mansfield Road, Spion Kop, Mansfield	B8	C3	0.39 ha
TOTAL					1,302.1 sqm and 3.89 ha

Source: MDC (2019): Mansfield Employment Land Monitoring Report 2019

Newark & Sherwood

N&SDC Officers undertook a review of their SHELAA to identify potential residential sites that are currently classed as employment use. Officers identified 5 existing employment sites that could potentially be suitable for release. These totalled **around 23 ha** and included:

- 16_0018 = PDF 53 = loss of former Flowserve industrial premises **18,212.5 sqm of B2 industrial (c. 4.55 ha @40% plot ratio)** for 324 dwellings (if outline application 19/00854_OUTM is approved);
- 16_0045 = PDF 16 = **8.54 ha to be lost**, relating to an existing B2 industrial site
- 16_0130 = PDF 67 = **4.25 ha of B2 industrial land to be lost** for 150 homes
- 16_0149 = PDF 70 = loss of **0.25 ha of local industrial unit**.
- 16_0134 = PDF 60 = 10.11 ha of B2 industrial land currently. The SHELAA identifies this site has having the potential to be redeveloped for mixed use, with the allocation including provision for at least 150 dwellings and 4,000 sqm (net) retail with potentially an element of employment land. Working on the (indicative) estimate of 35 dph and a plot ratio of 40% for the retail, this could suggest that the total net loss of employment land could be in the order of **around 5.5 ha**.

Furthermore, site 16_0002 PDF 16_0002 is a very large site, of around 281.52 ha, for both housing (3,150 dwellings) and employment use, but as this is currently agricultural land it would not actually result in the loss of existing employment so has not been included in the figures above.

Past Trends

As summarised in detail in Section 5.0, the 8 Councils provided data stretching back to 2011/12 for the five Core HMA districts and Mansfield District, and over a longer period for both Ashfield and Newark & Sherwood. As can be seen in Table 5.13, this ranged from a low of 21 sqm p.a. of office floorspace lost per annum in Gedling over the past 9 years, to as much as 11,366 sqm of commercial floorspace lost in Nottingham City every year (at least part of this can be attributed to the office to residential Permitted Development rights which came into force during the monitoring period). Losses of industrial (and to a lesser extent distribution) floorspace tended to be significantly greater, although not for Mansfield and Newark & Sherwood Districts. Nottingham City has lost 8,686 sqm of industrial floorspace every year since 2011/12, whilst Ashfield has lost over 8,206 p.a. going back even further, to 2000/02.

Table A1.6 Gross/Net Annual Net Office / Industrial Completion Rates

	Average Annual Office Floorspace Losses (sqm)	Average Annual Industrial / Distribution Losses (sqm)
Broxtowe	-1,276 sqm	-4,263 sqm
Erewash	-536 sqm	-3,177 sqm
Gedling	-21 sqm	-858 sqm
Nottingham	-11,366 sqm	-8,686 sqm
Rushcliffe	-267 sqm	-1,222 sqm
CORE HMA	-13,466 sqm	18,206 sqm
Ashfield	-528 sqm	-8,406 sqm
<i>...of which located in Hucknall</i>	<i>-26 sqm</i>	<i>-1,772 sqm</i>
Mansfield	-2,153 sqm	-794 sqm
Newark & Sherwood	-2,770 sqm	-347 sqm
OUTER HMA	-5,451 sqm	-9,547 sqm

Source: HMA Councils / Lichfields' Analysis

Churn

Clearly the aforementioned past trends data needs to be placed into context given the size of the respective economy – it is hardly surprising that Nottingham City has experienced a much greater level of losses of office and industrial floorspace than, say, Gedling, given the size of their respective economies and the amount of existing floorspace. The point to note is whether the past losses generally reflect the size of each district's economy, and whether this should be adjusted to allow for a degree of refurbishment to prevent the portfolio becoming increasingly unattractive to the market.

An alternative approach is therefore to analyse the rate of 'churn', which would be equivalent to a proportion of each Councils' existing stock per annum. A number of other ELRs have used a replacement figure of around 1% per annum¹⁰⁷, which would be the equivalent of the two HMA's entire stock being replaced over a period of 100 years. This has been acknowledged as a valid alternative approach (to adjusting for anticipated future losses) when translating net employment land needs into a gross planning requirement. A 0.5% replacement level would be the equivalent of the entire stock being replaced over 200 years. To put this into context, a widely used rule of thumb in the development industry suggests that high bay logistics units often have a much shorter shelf life of just 30-35 years before they become obsolete to modern distribution occupiers and require substantial refurbishment if not demolition and rebuild.

Other ELR studies¹⁰⁸ have noted that approximately 20% of historic completions have been achieved through (former) B-Use Class redevelopment (i.e. the re-use of formerly B-Use Class employment sites), with the remainder

¹⁰⁷ See, for example, Lichfield District Council's Employment Land Review 2014 Update and work covering the areas of: The West of England Updated Employment Evidence (Bath & North East Somerset, Bristol, North Somerset and South Gloucestershire) November 2018; Greater Exeter Economic Development Needs Assessment (Devon County, East Devon, Exeter, Mid-Devon, Teignbridge and Dartmoor National Park) March 2017 and Dartmoor National Park Employment Land Review, January 2018.

¹⁰⁸ West of England Joint Spatial Plan Area Updated Employment Evidence (2018)

requiring new sites. This suggests that there will likely be a requirement for a high proportion of replacement activity on new sites to deliver new employment land supply to meet modern occupier needs.

Table A1.7 compares the rate of replacement needed for the Nottingham Core/Outer HMAs' office/industrial stock. It assumes that 0.5% / 1% of the existing commercial / industrial floorspace would be replaced per annum (based on the existing floorspace for each district using the latest Business Rates VOA data for 2020) and netting off a further 20% (assuming that 1 out of 5 sites will be recycled for employment use).

Table A1.7 Nottingham Core/Outer HMA Replacement Rate Analysis (2020)

		Annual Replacement at 0.5%	Annual Replacement at 1%	Annual Trend Based (observed) losses*	% of Hereditaments built prior to 1940 (as at 2003)
Broxtowe	Office	280	560	1,276	42.6%
	Industrial & Warehousing	1,616	3,232	4,263	34.8%
	Total	1,896	3,792	5,539	37.5%
Erewash	Office	240	480	536	68.4%
	Industrial & Warehousing	3,816	7,632	3,177	39.5%
	Total	4,056	8,112	3,713	45.4%
Gedling	Office	188	376	21	49.7%
	Industrial & Warehousing	1,860	3,720	858	32.1%
	Total	2,048	4,096	879	38.5%
Nottingham City	Office	2,900	5,800	11,366	62.7%
	Industrial & Warehousing	7,368	14,736	8,686	40.7%
	Total	10,268	20,536	20,052	49.3%
Rushcliffe	Office	480	960	267	59.9%
	Industrial & Warehousing	1,840	3,680	1,222	38.2%
	Total	2,320	4,640	1,489	47.1%
Ashfield	Office	428	856	528	42.9%
	Industrial & Warehousing	4,936	9,872	8,406	28.0%
	Total	5,364	10,728	8,934	31.1%
Mansfield	Office	376	752	2,153	50.4%
	Industrial & Warehousing	2,340	4,680	794	26.7%
	Total	2,716	5,432	2,945	35.2%
Newark & Sherwood	Office	376	752	2,770	67.4%
	Industrial & Warehousing	3,468	6,936	346	27.4%
	Total	3,844	7,688	3,116	40.6%

Source: Lichfields analysis/VOA Business Floorspace (2020) / DCLG (2004): Age of commercial and industrial stock: local authority level 2004 (Table 3.1)

*Using a standard 40% plot ratio to translate land to floorspace where appropriate

The Table indicates that whilst the likes of Broxtowe, Nottingham City and Ashfield are seeing losses broadly in line with the level that might be expected given the size of each district's respective economy, for many of the other districts, the recorded losses appear on the low side. This is particularly the case for Newark and Sherwood's industrial and warehousing stock, where only a small fraction of the existing floorspace is being recorded by Officers as being lost each year (in stark contrast to the office data where the reverse is true); Mansfield's industrial and warehousing stock replacement (where a similar

pattern emerges) and both office and industrial floorspace losses in Gedling District.

Furthermore, as set out in the Table, and based on rather dated 2003 VOA information, it should be noted that Nottingham City has a higher proportion of older stock than anywhere else in the sub-region, with 63% of all office units dating from before WWII. This compares to 56.2% across the East Midlands and 51.0% for England and Wales. This could suggest a higher rate of churn may be required to address the high proportion of older stock that is less likely to be fit to meet the needs of modern-day occupiers.

In contrast, all three Outer HMA districts tend to have more modern industrial/warehousing stock, with Mansfield District in particular having just 26.7% of its stock dating from before WWII, compared to 32.8% across the East Midlands and 32.4% for England and Wales, which could suggest that a lower rate of industrial replacement could be appropriate in these areas.

Appendix 2 Site Appraisal Maps

Figure A2.1 Broxtowe Borough Strategic Employment Site Appraisals Map

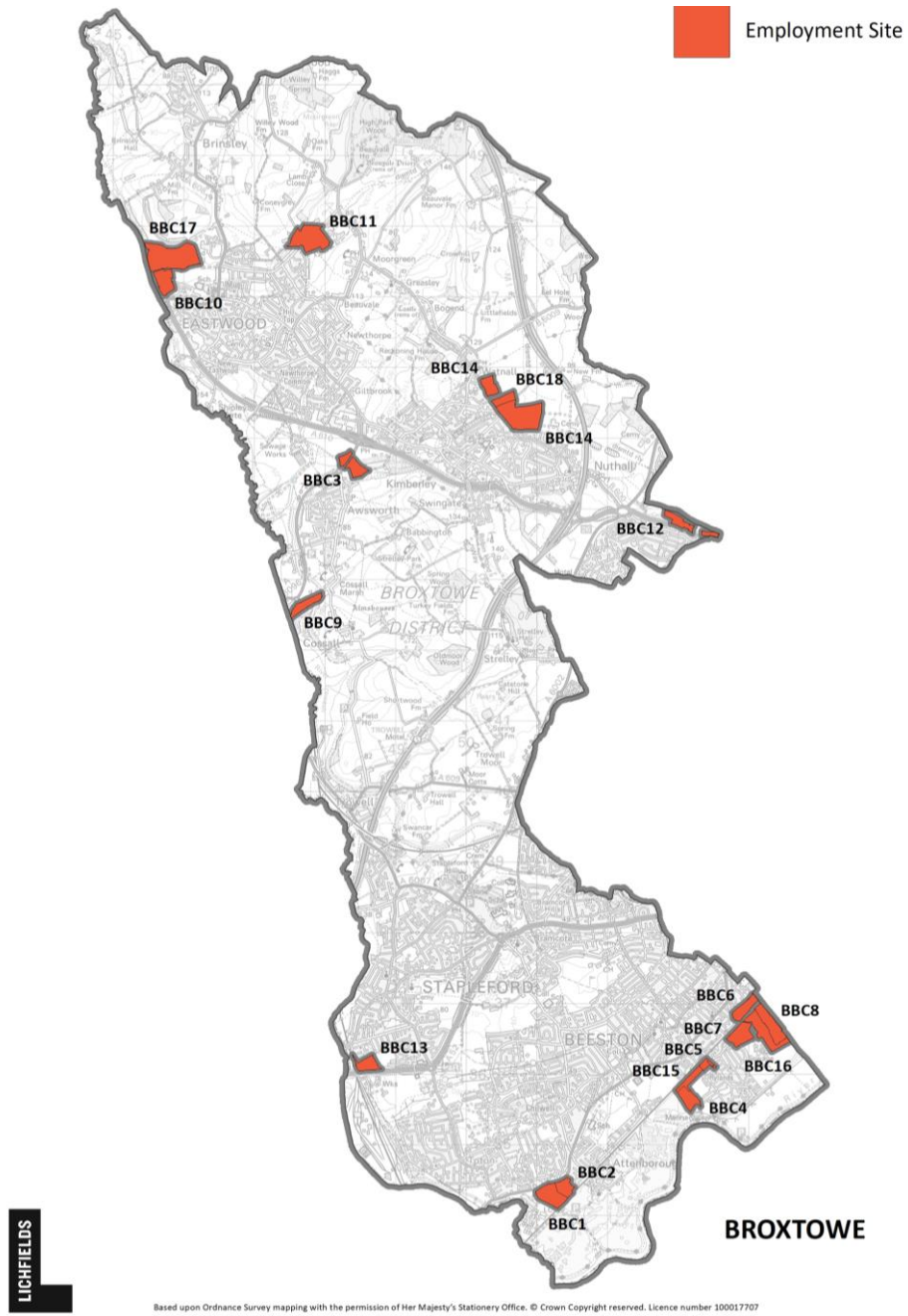

Source: 8 District Councils / Lichfields' Analysis

Figure A2.2 Erewash Borough Strategic Employment Site Appraisals Map

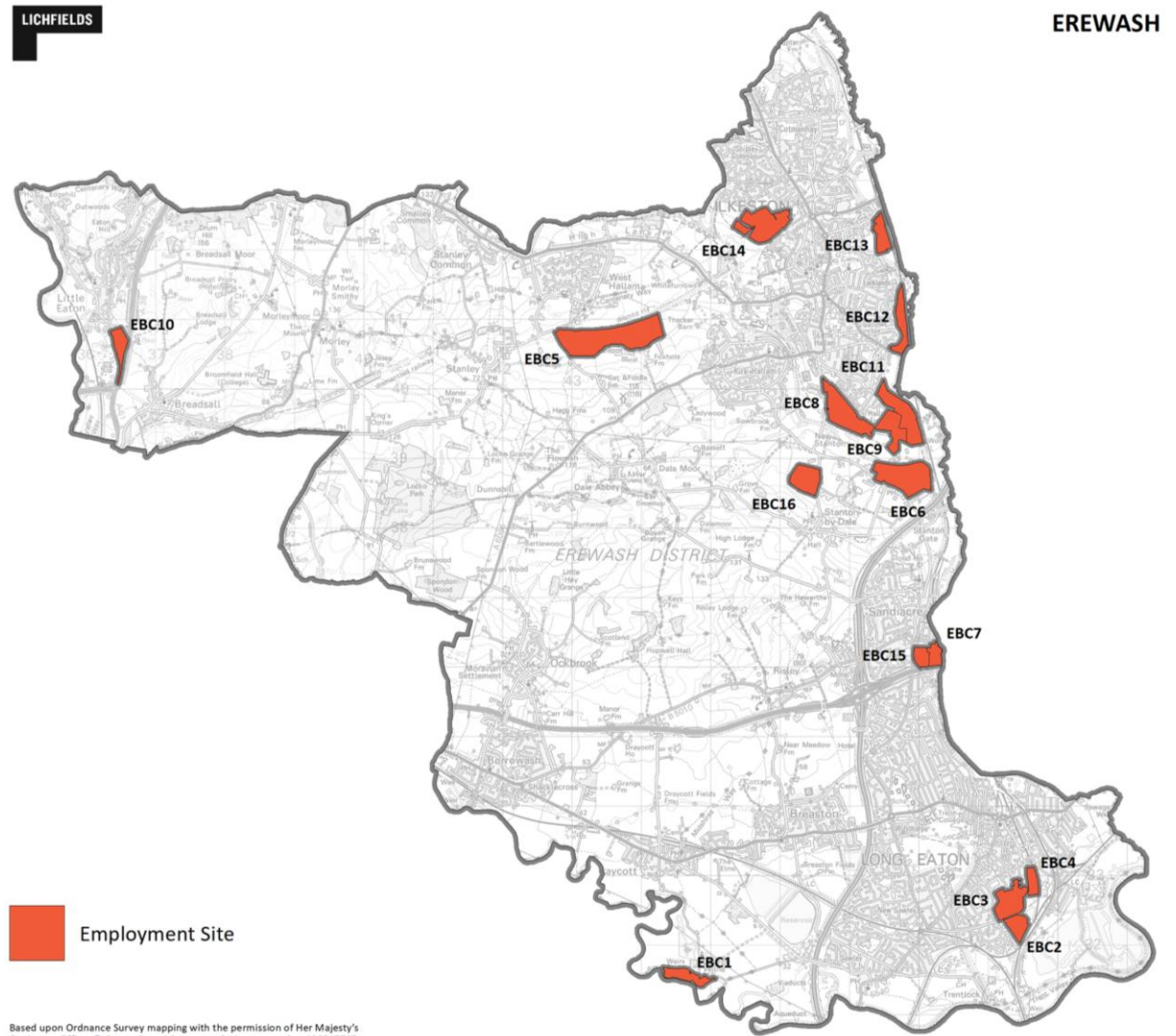

Source: 8 District Councils / Lichfields' Analysis

Figure A2.3 Gedling Borough Strategic Employment Site Appraisals Map

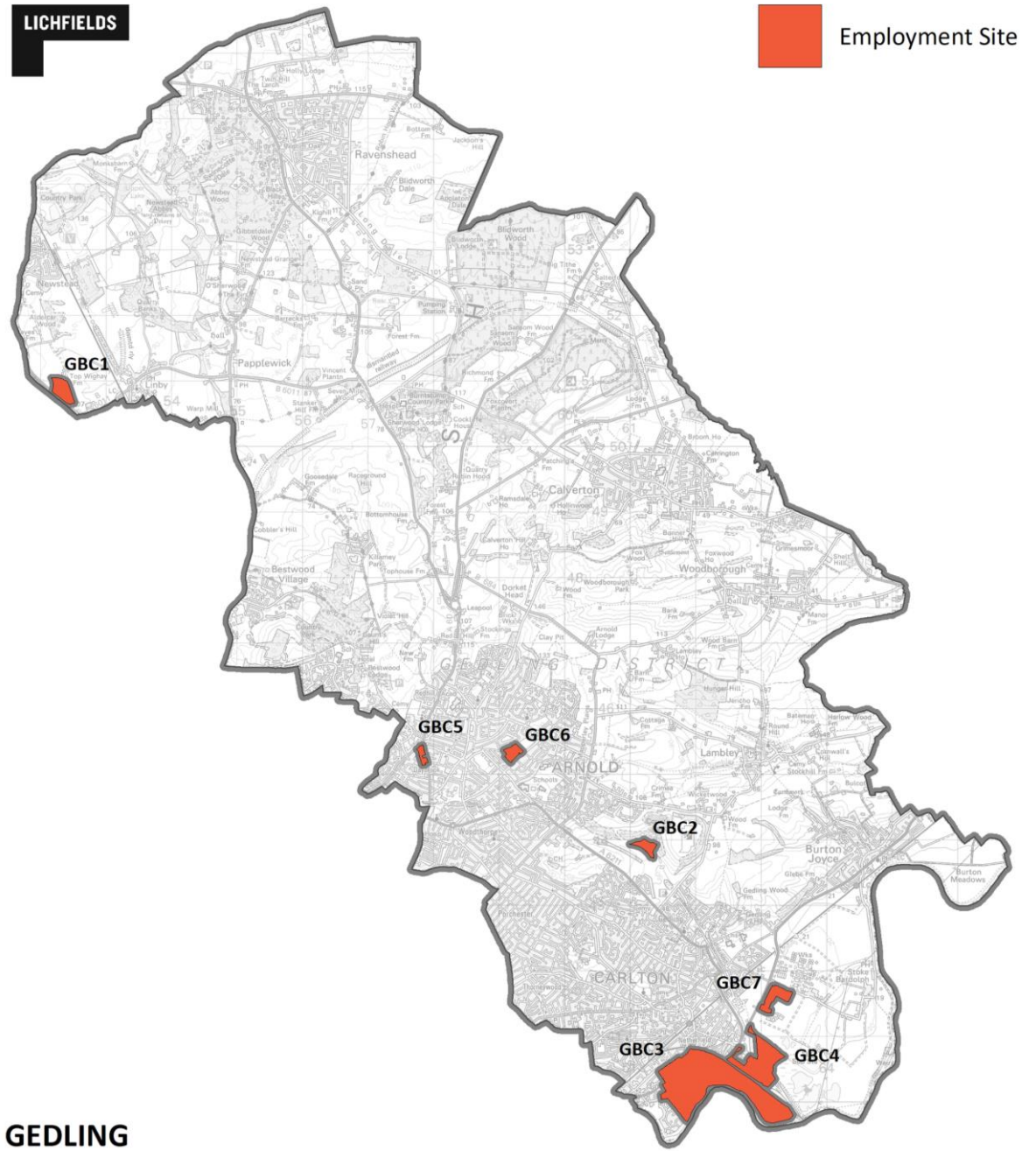

Based upon Ordnance Survey mapping with the permission of Her Majesty's Stationery Office. © Crown Copyright reserved. Licence number 100017707

Source: 8 District Councils / Lichfields' Analysis

Figure A2.4 Nottingham City Strategic Employment Site Appraisals Map

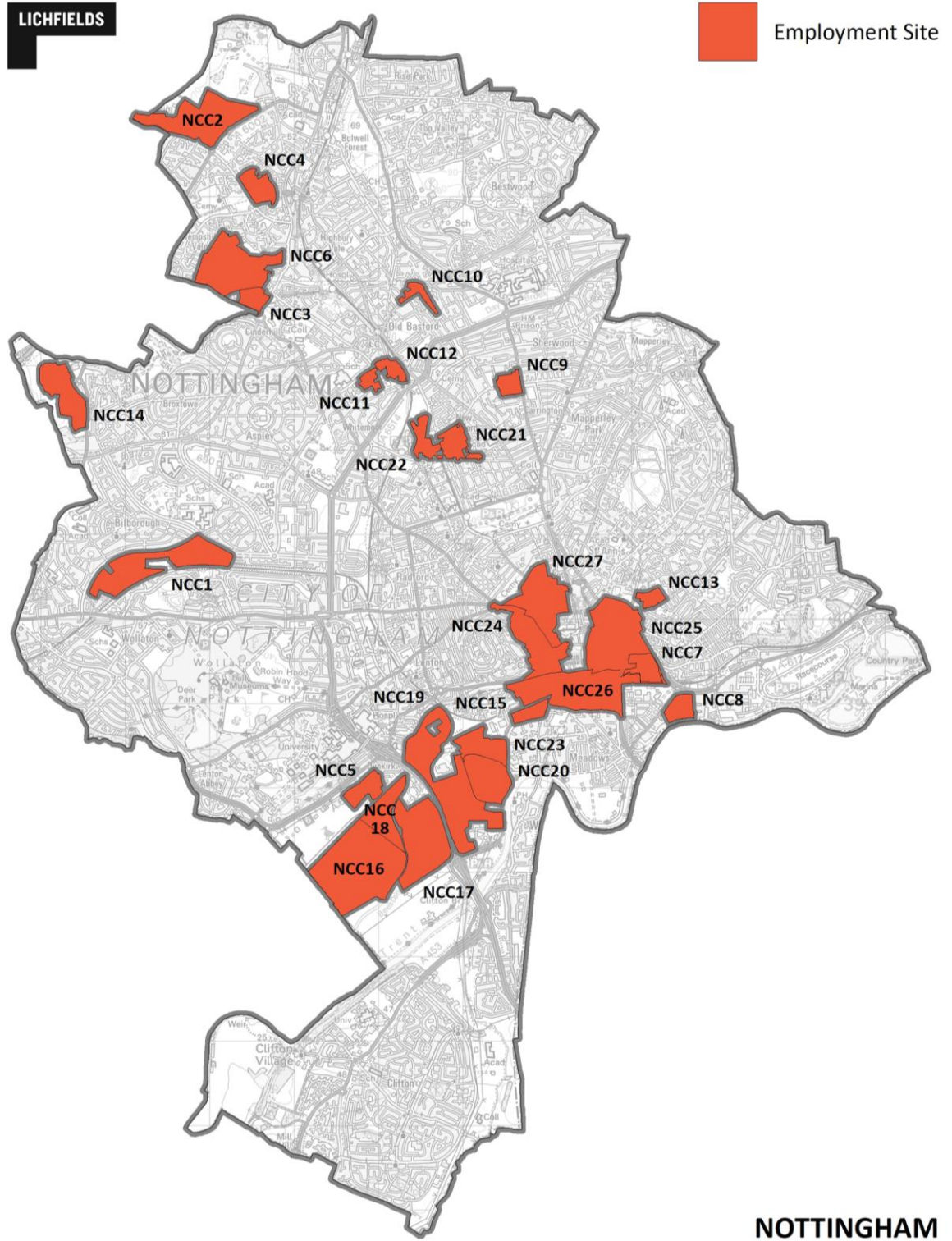

Based upon Ordnance Survey mapping with the permission of Her Majesty's Stationery Office. © Crown Copyright reserved. Licence number 100017707

Source: 8 District Councils / Lichfields' Analysis

Figure A2.5 Rushcliffe Borough Strategic Employment Site Appraisals Map

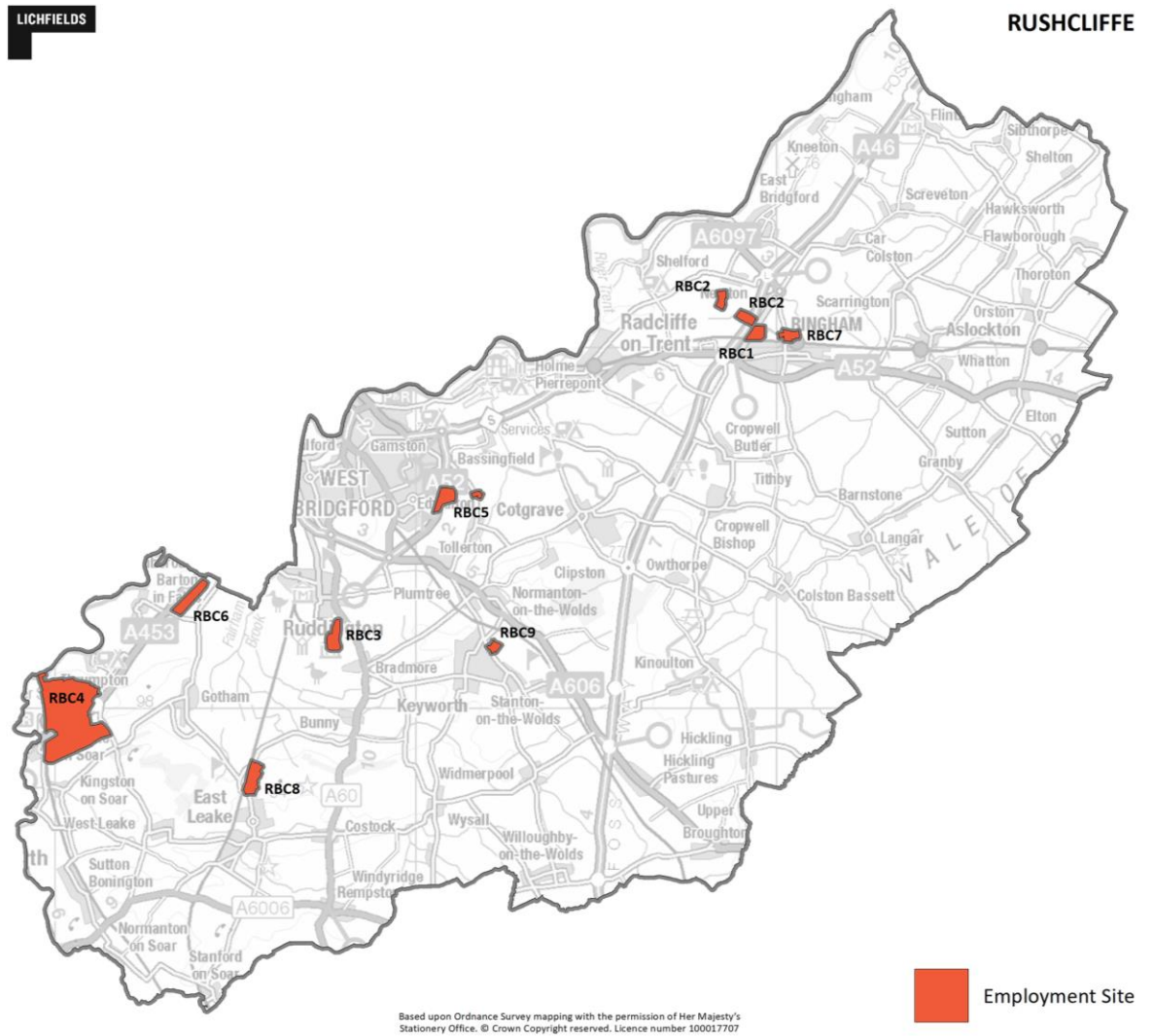

Source: 8 District Councils / Lichfields' Analysis

Figure A2.6 Ashfield District Strategic Employment Site Appraisals Map

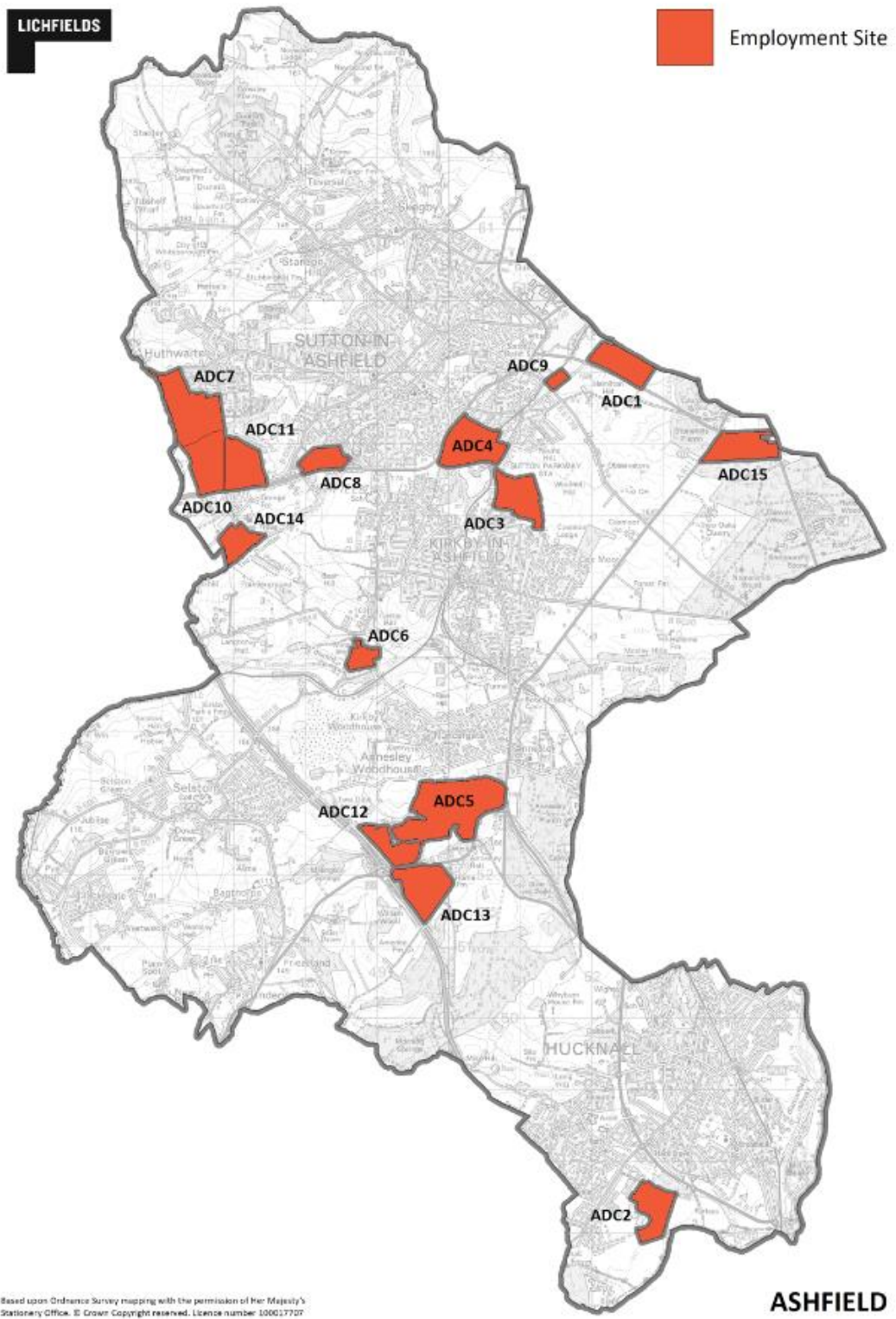

Source: 8 District Councils / Lichfields' Analysis

Figure A2.7 Mansfield District Strategic Employment Site Appraisals Map

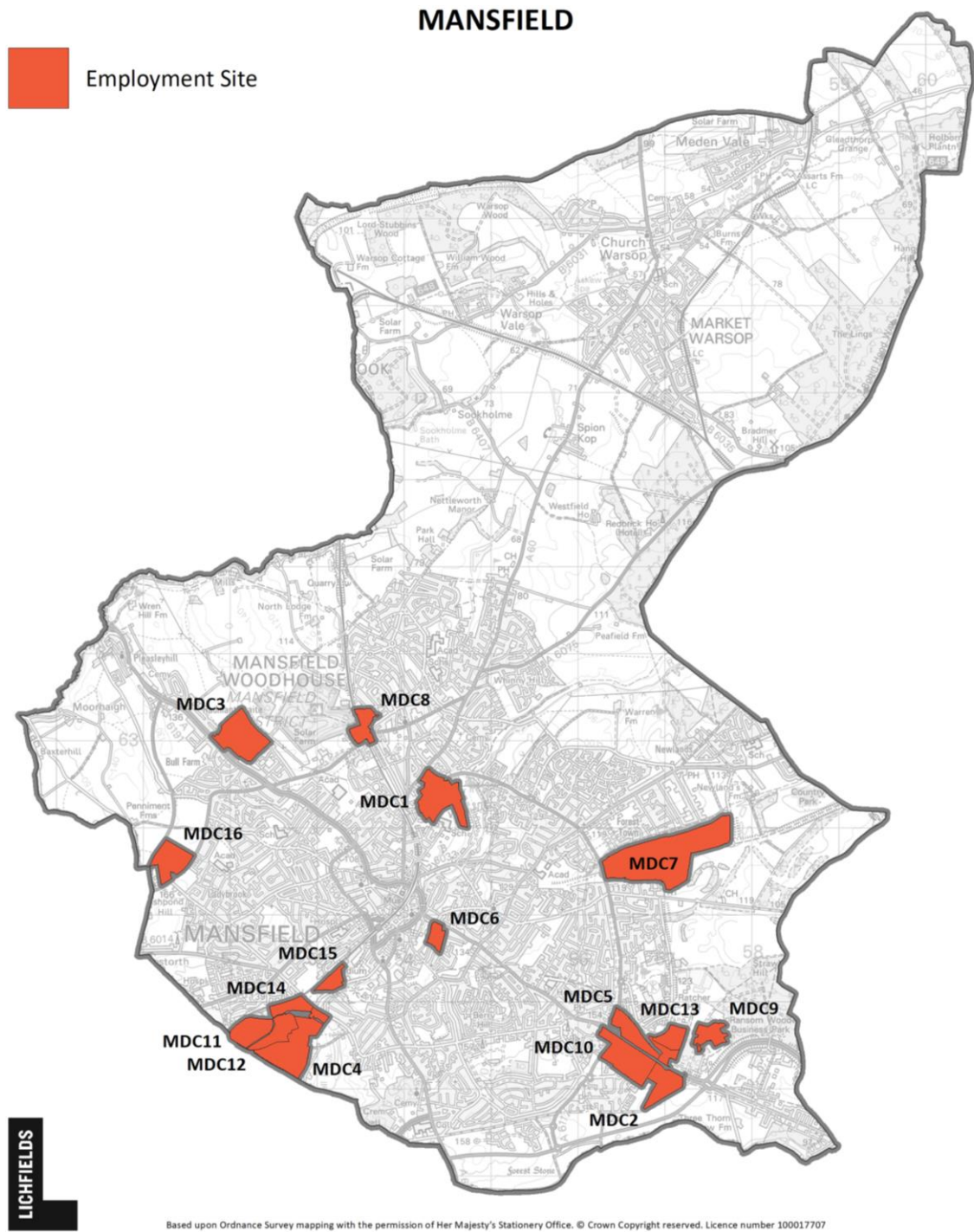

Source: 8 District Councils / Lichfields' Analysis

Figure A2.8 Newark & Sherwood District Strategic Employment Site Appraisals Map

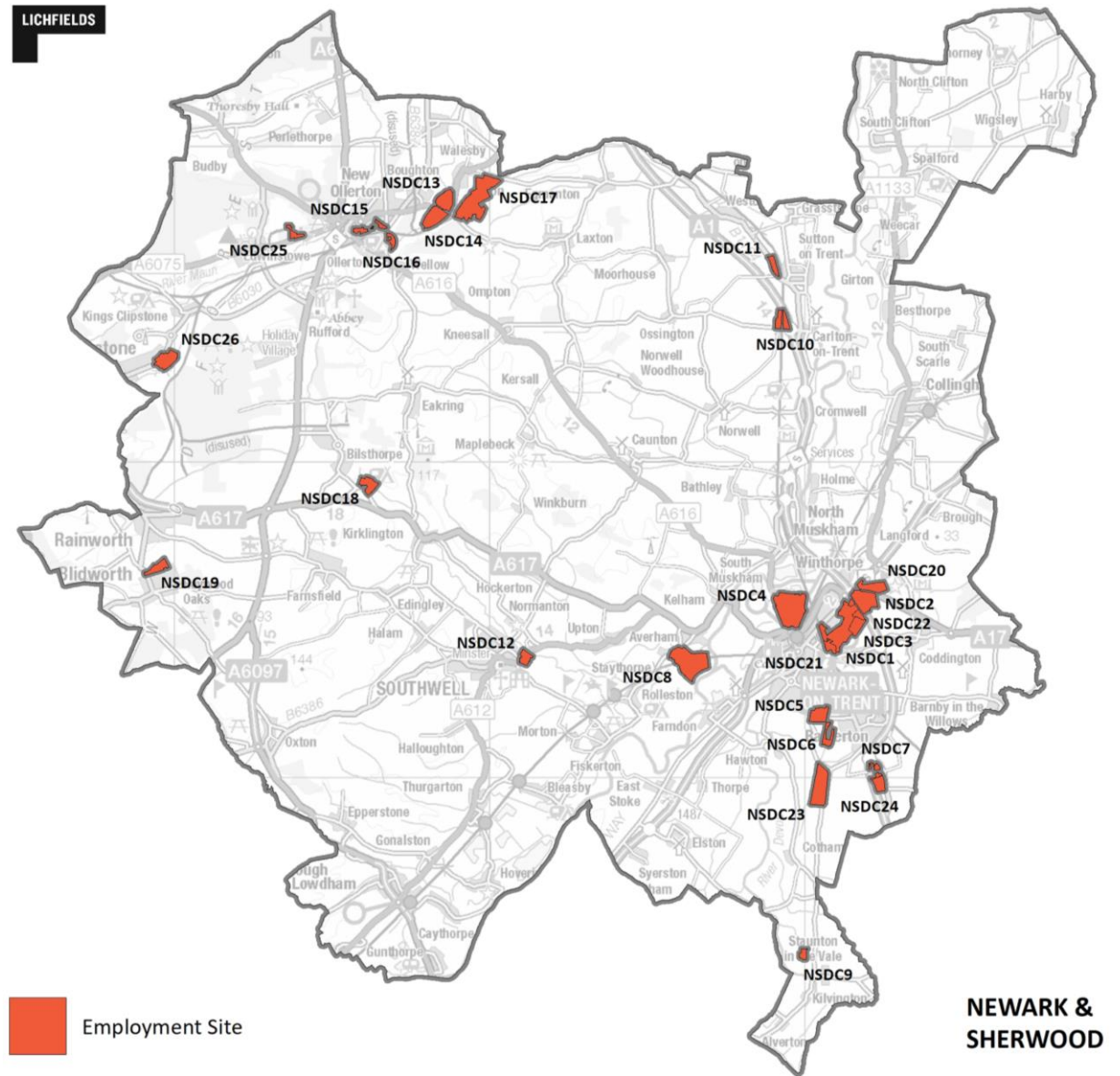

Based upon Ordnance Survey mapping with the permission of Her Majesty's Stationery Office. © Crown Copyright reserved. Licence number 100017707

Source: 8 District Councils / Lichfields' Analysis

Appendix 3 Gross to Net Plot Adjustments

GROSS TO NET ADJUSTMENTS IN EMPLOYMENT LAND ASSESSMENTS

Take-up of employment land is typically recorded on a plot by plot basis, which equates to a net developable area. To be consistent, availability should be measured on the same basis. So for some sites, gross to net adjustments may be appropriate.

We have considered each site and estimated the proportion of land likely to be lost to servicing and landscaping, having regard to gross to net ratios achieved on industrial estates and business parks elsewhere in the region. Research by storeys:ssp has shown that ratios range from 100% where a site is in single occupation, to 56% for a business park on a sloping site with large areas set aside for landscaping and sloping banks between development plots.

Adjustments appropriate in different circumstances are set out below.

GROSS TO NET RATIOS ADJUSTMENTS FOR EMPLOYMENT LAND

Type	Ratio	Comment
Serviced plot on Industrial estate fronting road.	100%	
Area of land that could easily subdivide into serviced plots with road frontage.	100%	
Large area of land on Industrial estate too big for single scheme, having regard to other buildings on estate.	95%	Provision for spur road.
Major undeveloped part of Industrial estate or extension to Industrial estate.	90%	Provision for roads and landscaping to one or more sides.
Small local allocation, requiring Infrastructure.	90%	Provision for spur road, but landscaping likely to be minimal.
Level site allocated for Industrial estate.	85%	Provision for spur road and landscaping.
Site allocated for Industrial estate where terracing or bunding required.	80%	Provision for spur road and landscaping.
Land allocated for business park with high landscape quality.	75%	Provision for spur road extensive landscaping, balancing ponds etc.
Land allocated for employment use where a single end user could be in the market.	100%	All land to be taken by single user, surplus areas to be kept for its expansion.

Appendix 4 Site Assessment Pro-Forms

Summit Park, Sherwood Way South (Ref: ADC1)



**GROSS SITE AREA:
27.00 ha**

**ESTIMATED NET DEVELOPABLE
AREA:
1.9 ha**

CRITERIA	COMMENT	RATING
<p>Site Context</p> <ul style="list-style-type: none"> • Location with regards to existing employment areas and other sites • How the site fits into the overall portfolio 	<p>This site accommodates a new Amazon Distribution Centre. It is adjacent to the Hermitage Lane Industrial Area and Oakham Business Park (Mansfield). The boundary between Ashfield and Mansfield Local Authorities runs along the northern boundary of the site.</p>	
<p>Local Plan Designation</p>	<p>The Ashfield Local Plan Review (November 2002) and the policies saved by the Secretary of State direction in 2007 comprise the development plan for Ashfield. The site is allocated as Employment Land (Policy EM1Re) and is outside the main urban area (Policy ST2). The employment allocation comprises of 23.5 ha net area.</p> <p>The site borders identified Countryside (Policy EV2) and Mature Landscape Area (Policy EV4) to the east, south and west.</p>	
<p>Status in SHLAA</p>	<p>The Amazon site is identified in the 2015 Strategic Employment Land Availability Assessment (SELAA) (site ref. S1) as immediately available. The vacant development plot in the north of the site was identified (site ref. S2) as immediately available and comprises of 1.9ha.</p>	
<p>Planning History</p>	<p>Outline planning permission (ref. V/2000/0710) was granted in 2004 for employment uses on 17ha of the site. Subsequent reserved matters and full planning applications for employment uses were granted but not implemented. In April 2019 full planning permission (ref. V/2019/0101) was</p>	

	<p>granted for a distribution warehouse with ancillary office space, with a total floorspace of 162,791 sqm on 19.3ha of the site. This has been implemented and is occupied by Amazon.</p> <p>Full planning permission (ref. V/2019/0416) was also granted in March 2020 for 9,550 sqm office and industrial space on 1.86 ha of the site fronting Hamilton Way. This has not yet been implemented.</p>	
Current Use and Land Type	This is a former greenfield site and is now predominantly occupied by the new Amazon distribution centre.	
Occupier Profile (if partly developed, including % of available land and levels of vacancy onsite)	<p>The site is occupied primarily by an Amazon fulfilment centre and extensive staff parking facilities.</p> <p>Land in the north of the site fronting Hamilton Way has not been developed as part of the Amazon scheme. It comprises of 1.9 ha of land with planning permission for light industrial and warehouse uses, it has been sold by Savills but the permission has not yet been implemented.</p>	
Strategic Road Access	The site is adjacent to the A617 Sherwood Way South. The A617 connects Chesterfield to the east and Newark-on-Trent to the west. The A617 provides access to the A60 approximately 2.5km to the east which provides access to Mansfield to the north and Nottingham to the south. The A617 also provides access to the A38 approximately 1.5km to the west which provides access to Mansfield and to Junction 28 of the M1 Motorway approximately 8km away. The site is also within 3km of the A611.	Average
Local Road Access	Very good local access, the site is accessed from the A617 and Hamilton Road to the west, both are good free-moving roads.	Very Good
Proximity to Urban Areas and Access to Labour and Services (including public transport / cycling / walking accessibility)	The site is between Mansfield and Sutton in Ashfield with easy access to their services, facilities and labour market. There is an onsite bus station providing access to the local area for Amazon employees. The site is approximately 3km from both Sutton Parkway and Mansfield railway stations.	Good
Compatibility of Adjoining Uses (including amenity impacts experienced by current/future occupiers and neighbouring areas)	The site is bounded by the border between Ashfield and Mansfield District, Oakham Business Park and the Hermitage Lane Industrial Area to the North, a farm track and agricultural greenfield land to the east, the A617 to the south with agricultural land beyond and Hamilton Road to the west with King's Mill Reservoir beyond.	Very Good
Developmental and Environmental Constraints (e.g.	This is a large relatively level site with utilities and communications infrastructure in place. It is	Average

<p>size; topography; site access; roads, lighting, landscaping, mains utilities and communications infrastructure; flood risk; contamination; nature and heritage conservation)</p>	<p>within Flood Zone 1 and therefore at low risk of flooding. There is a scheduled monument – Mound on Hamilton Hill (ref. 1002921) approximately 100m south of the site. There is also the King’s Mill Viaduct scheduled monument (ref. 1006374) approximately 400m north of the site.</p> <p>The majority of the site is classed as a major aquifer of high vulnerability. There is a drainage basin in the south east corner of the site with a drainage channel running along the eastern border.</p> <p>There is Hamilton Hill Local Wildlife Site (LWS) approximately 100m south of the site, Cauldwell Brook Marsh LWS adjacent to the eastern boundary with Cauldwell Brook Marsh LWS beyond. Kings Mill Reservoir Local Nature Reserve and LWS is approximately 400m north of the site with Hermitage Mill Pond LWS adjacent.</p>	
<p>Barriers to Delivery and Mitigation (including ownership constraints - if known)</p>	<p>The majority of the site is built out with only 1.9ha remaining. The vacant part of the site has planning permission for office and industrial uses but this has not yet been implemented.</p>	<p>Very Good</p>
<p>Market Attractiveness (including appropriateness, vacancy and market activity on site for the type of development proposed)</p>	<p>This is a highly visible site between Sutton in Ashfield and Mansfield, adjacent to the A617 and in close proximity of the A38 and Junction 28 of the M1 Motorway. The majority of the site has been developed for an Amazon distribution centre with the remaining 1.9ha benefiting from planning permission for office and industrial space, albeit this has not yet been implemented. It provides a prestigious employment site appealing to both a regional and local market.</p>	<p>Very Good</p>
<p>Strategic Fit with Growth Area Objectives (by target Market Segment)</p>	<p>This site already accommodates key industrial growth sectors as identified in the D2N2 Vision 2030 document including retail and logistics.</p>	<p>Very Good</p>
<p>OVERALL SITE RATING</p>	<p>Very Good</p>	
<p>Recommendation and Potential Future Uses</p>	<p>Allocate for employment uses (i.e. retain current employment designation)</p>	
<p>SITE SUMMARY:</p>		
<p>This is a highly visible site between Sutton in Ashfield and Mansfield, adjacent to the A617 and in close proximity of the A38 and Junction 28 of the M1 Motorway. It is adjacent to the Hermitage Lane Industrial Area and Oakham Business Park (Mansfield) with the boundary between Ashfield and Mansfield Local Authorities along the northern boundary of the site. The site is occupied primarily by a new Amazon fulfilment centre and extensive staff parking facilities. Land in the north of the site fronting Hamilton Way has not been developed as part of the Amazon scheme. It</p>		

comprises of 1.9 ha of land with planning permission for light industrial and warehouse uses, it has been sold by Savills but the permission has not yet been implemented. The site is currently allocated for employment uses in the Local Plan and it is recommended that this allocation be retained.

Harrier Park (Ref: ADC2)



**GROSS SITE AREA:
27.05 ha**

**ESTIMATED NET DEVELOPABLE
AREA:
20 ha**

Note: Excluding the developed B2/B8 employment site 4.83 ha; but including land now proposed for residential development to the southwest of the Rolls Royce plant (ref: V/2020/0553), if approved this would reduce the net developable area by 4.91 ha, Furthermore, a gross to net adjustment of 90% has been applied.

CRITERIA	COMMENT	RATING
<p>Site Context</p> <ul style="list-style-type: none"> • Location with regards to existing employment areas and other sites • How the site fits into the overall portfolio 	<p>The site comprises of land identified for employment uses within the wider Harrier Park mixed-use development at Rolls-Royce Hucknall (V/2013/0123). Harrier Park will be a high quality industrial and distribution business park of up to 101,818 sqm to the east of the existing industrial area accessed from the A611 Hucknall bypass and residential/community uses to the south of the industrial area accessed from Watnall Road.</p> <p>The site is adjacent to the Hucknall Industrial Estate existing employment area and Rolls Royce Hucknall premises. It is approximately 3.2km north of the Blenheim Industrial Estate in Nottingham. The Nottingham City Council boundary is approximately 300m south of the site and the Broxtowe boundary is approximately 500m west of the site.</p>	
<p>Local Plan Designation</p>	<p>The Ashfield Local Plan Review (November 2002) and the policies saved by the Secretary of State direction in 2007 comprise the development plan for Ashfield.</p>	

	<p>The majority of the site is within the main urban area with the exception of a very small area in the north-eastern corner and a strip across the south of the site. The northern half of the site is unallocated. The current Rolls-Royce site adjacent to the west is identified as Employment Land (Policy EM1) and this allocation spreads across this site too, to the eastern boundary. This allocation has been partly built out with the construct of the Rolls Royce manufacturing facility in 2005. The remainder of the allocation is included within the outline planning permission for a mixed used development V/2013/0123 comprising a residential development and business park (Harrier Park). Harrier Park has a new access constructed from the A611 (Hucknall By pass).</p> <p>The southern area of the site is allocated as an Open Air Testing Zone at Rolls Royce (policy Ref: EM2). The Green Belt (Policy EV1) wraps around the site to the north, east and south.</p>
<p>Status in SHLAA</p>	<p>The site is identified in the 2015 Strategic Employment Land Availability Assessment (SELAA) Rolls Royce, Watnall Rd/Hucknall Bypass, Hucknall (site ref. H1). It is a substantial site which is identified as sub regional importance in presenting employment opportunities locally. The site forms part of a mixed-use development of approximately 140 ha. The business park is located close to Hucknall Bypass and provides approximately 27 ha of land for development. Anticipated that works will start on site for the construction of the new road and provision of services to the site in the near future. Available within next three years.</p>
<p>Planning History</p>	<ul style="list-style-type: none"> • Full detailed planning permission (ref. 2003/1197) was granted in 2004 for a Rolls Royce Manufacturing Facility, Car Parking and Access and Removal of Part of Runway, for aggregate. This has been developed and is adjacent to the site. • Full detailed planning permission (ref. 2012/0436) was granted in December 2012 for a Rolls Royce Production Facility with Ancillary Offices, Service Yards and Car Parking (Amendment to Plant, Inclusion of Retaining Wall, Realignment of Road/Service Yard Access) to the north of the main Rolls Royce premises (site area 3.47 ha). This is within the site boundary but has not been implemented. <p>In 2014, planning permission (ref. V/2013/0123) was granted for:</p> <ul style="list-style-type: none"> • Outline planning permission for a new business park on 27.8ha of land; residential development on 31.2ha of land to include affordable housing; two accesses off Watnall road; public open space provision; one-form entry primary school; provision for community facilities; local retail; pub/restaurant; care home; strategic

	<p>footpath and cycle link; and nature conservation enhancement on 58ha of green belt land; and</p> <ul style="list-style-type: none"> • Full detailed planning permission for a new access to the proposed business park from the A611, Hucknall bypass on 4.4ha of land. This access road from the A611 is now complete. • Full planning permission (ref. V/2019/0433) was subsequently granted in November 2019 for a general industrial and storage and distribution building with associated service yard and car parking to the west of Harrier Way and north of the Rolls-Royce plant (site area of 4.83ha). This is to be occupied by educational resource provider RM Resources. This is developed and is within the site boundary. • An outline application was submitted in August 2020 (ref. V/2020/0553) for a mixed-use residential and commercial development and is pending determination. The site area comprises approximately 12.9 hectares and up to 366 dwellings are proposed on the site. <p>Land to the southeast of the Rolls-Royce plant and within the appraisal site boundary is now proposed to come forward for residential development (Phase 9) rather than employment uses. This is a proposed alteration to the masterplan set out under the outline permission V/2013/0123. The land, currently identified for employment purposes, is proposed to be utilised for residential development, the site area is identified as 4.91 ha (Application ref: V/2020/0533, Plan ref: Parameter Plan Dwg No11897-01-105 Rev F). This is within the site boundary.</p> <p>Proposed residential development identified as Phase 5b, comprising 3.98 ha (Application ref: V/2020/0533, Plan ref: Parameter Plan, Dwg No11897-01-105 Rev F). The buildings, now demolished, were occupied by Rolls-Royce production hangers located to the south west of the Rolls-Royce plant off Harrier Way. This is outside of the site boundary.</p> <p>The proposals also include additional land to be incorporated into the business park for employment purposes with a site area of approximately 1.10 ha (Application ref: V/2020/0533, Plan ref: Parameter Plan, Dwg No11897-01-105 Rev F). This is to the northwest of the Rolls-Royce plant and east of the playing fields. This is outside of the site boundary.</p>
<p>Current Use and Land Type</p>	<p>This is a part brownfield site and part greenfield site. A plot within the north has been developed for B2/B8 uses and the remaining brownfield area comprises of cleared development site. The site was formerly partially occupied by runways associated with the RAF Hucknall Aerodrome, the Grade II Listed aircraft hangers remain to the west of the site.</p>

Occupier Profile (if partly developed, including % of available land and levels of vacancy onsite)	The access road from the A611 is now complete. A substantial general industrial and storage and distribution building with associated service yard and car parking to the west of Harrier Way and north of the Rolls-Royce plant is also complete (site area 4.83 ha). It provides a new 18,200sqm national headquarters for educational resource provider RM Resources.	
Strategic Road Access	The site is adjacent to and accessed from the A611 Hucknall bypass and is approximately 7km from Junction 26 and 9km from Junction 27 of the M1 motorway. The A611 which runs through Ashfield from Mansfield to Nottingham and is one on the major access routes to Nottingham.	Average
Local Road Access	The site is accessed via Harrier Way directly from the A611 Hucknall Bypass. The A611 provides good free-moving access to the site.	Very Good
Proximity to Urban Areas and Access to Labour and Services (including public transport / cycling / walking accessibility)	The site is approximately 2.7km from the centre of Hucknall and adjacent to a large employment area. There is Public Bridleway along the sites' northern boundary which joins the adjoining employment area and residential area and amenities (including a Co-op and Sainsburys convenience store) along Watnall Road to the west with the Farley's Lane Nature Reserve to the east. There are bus stops on Watnall Road (within 800m) with regular services to Hucknall and Derby. Hucknall railway station is also approximately 3km from the site.	Good
Compatibility of Adjoining Uses (including amenity impacts experienced by current/future occupiers and neighbouring areas)	The site is bound to the north by Farley's Lane Nature Reserve with the A611 beyond; by former Hucknall Aerodrome runway areas and Bulwell Hall Park to the east; by open countryside to the south; and by the Rolls Royce Hucknall premises (accessed through the site via Harrier Way) and the Hucknall Industrial Estate to the west with the Harrier Park residential development to the southwest. The Green Belt wraps around the site to the north, east and south.	Good / Average
Developmental and Environmental Constraints (e.g. size; topography; site access; roads, lighting, landscaping, mains utilities and communications infrastructure; flood risk;	This is a large, level site and is currently partially occupied by new industrial warehouses and undeveloped plots with outline permission for employment uses. There is good access to the site from the Hucknall bypass via Harrier Way. The majority of the site is within Flood Zone 1. A small area in the northeast of the site is within	Average

<p>contamination; nature and heritage conservation)</p>	<p>Flood Zone 2 and 3 associated with Farley's Brook. The drainage strategy forming part of the outline planning application has been agreed with the Environment Agency.</p> <p>Five listed buildings are recorded as within 500m of the boundary of the site, these are associated with the former aerodrome use and include:</p> <ul style="list-style-type: none"> • Hangars 1 and 2 (at K and M Hauliers) Grade II Listed (listing ref. 1234854) • Hangars 3 and 4 (at K and M Hauliers) Grade II Listed (listing ref. 1275906) • Wing Test Hangar and concrete de-tuner supports to the west Grade II Listed (listing ref. 1454439) <p>Hucknall Airfield Local Wildlife Site is within the site and Two UK BAP species have been recorded on the area which has planning permission. Mitigation measures have been agreed as part of the planning permission. Immediately southeast of the site is the Bullwell Hall Park Meadows Local Nature Reserve and Local Wildlife Site beyond (within Nottingham City Council authority area).</p> <p>There are no known infrastructure/contamination issues.</p>	
<p>Barriers to Delivery and Mitigation (including ownership constraints - if known)</p>	<p>4.83 ha of the site has been developed for B2/B8 uses and the remaining area of the site has outline planning permission (ref. V/2013/0123) for employment uses. However, land to the southeast of the Rolls-Royce plant and within the appraisal site boundary is now proposed to come forward for residential development (Phase 9) rather than employment uses (V/2020/0553). This site comprises of 4.91ha.</p> <p>The other constraints to development have already been addressed in the outline application and will need to be addressed in any future reserved matters applications.</p>	<p>Very Good</p>
<p>Market Attractiveness (including appropriateness, vacancy and market activity on site for the type of development proposed)</p>	<p>This is an accessible site located adjacent to a labour market and approximately 11km from the 'Regional Centre' of Nottingham (as identified in D2N2 Vision 2030 document). The site is only 2.7km from the centre of Hucknall and approximately 7km from Junction 26 / 9km from Junction 27 of the M1 motorway.</p>	<p>Very Good</p>

	<p>Harrier Park is being marketed as a high-quality manufacturing and distribution business park offering 64 acres or 1 million sqft employment space with design and build opportunities. One of the new units to the north east of the Rolls-Royce site, off Harrier Way, was completed in December 2020 and provides a new 18,200sqm national headquarters for educational resource provider RM Resources.</p> <p>Any occupier will also benefit from neighbouring Rolls-Royce, a name synonymous with quality throughout the world.</p>	
Strategic Fit with Growth Area Objectives (by target Market Segment)	The proposals for Harrier Park will create a high-end business park, offering E (office), B2 and B8 accommodation which is anticipated to encourage inward investment to the Hucknall area, as well as accommodating local and regional company expansions. The site has significant potential to attract production/distribution uses and other growth sectors as identified in the D2N2 Vision 2030 document such as transport equipment manufacturing or professional/business services.	Very Good
OVERALL SITE RATING	Very Good	
Recommendation and Potential Future Uses	Allocate for employment uses, with the exception of land proposed for residential development under pending planning application ref. V/2020/0553 to the south east of the Rolls-Royce plant.	
SITE SUMMARY:		
<p>This site comprises of land identified for employment development within the wider Harrier Park mixed-use development at Rolls-Royce Hucknall. Harrier Park comprises of a high quality industrial and distribution business park to the east of the existing industrial area accessed via a new link road from the A611 Hucknall bypass and residential/community uses to the south of the industrial area accessed from Watnall Road.</p> <p>The site comprises of a new 18,200sqm national headquarters for educational resource provider RM Resources and undeveloped plots with outline permission for employment uses. The site is approximately 2.7km from the centre of Hucknall and adjacent to the Hucknall Industrial Estate. There is pedestrian access to the surrounding residential areas and bus stops adjacent to the site. Hucknall railway station, junctions 26 and 27 of the M1 Motorway and Nottingham City are within close proximity.</p> <p>Land to the southeast of the Rolls-Royce plant and within the appraisal site boundary is now proposed to come forward for residential development rather than employment uses (ref. V/2020/0553). This is a proposed alteration to the masterplan set out under the outline permission (ref. V/2013/0123). If approved and developed for residential, this would reduce the net developable area by 4.91 ha. In addition, a 1.1ha area of land east of the playing fields/north of the Rolls-Royce plant is proposed to be incorporated into the new Harrier Park business park for employment uses, this outside the appraisal site boundary.</p>		

It is recommended that this site is allocated for employment uses, albeit the land proposed for residential development under pending planning application ref. V/2020/0553 should be excluded from the employment allocation boundary.

Lowmoor Business Park (Ref: ADC3)



GROSS SITE AREA:
30.79 ha

ESTIMATED NET DEVELOPABLE AREA:
0 ha

CRITERIA	COMMENT	RATING
<p>Site Context</p> <ul style="list-style-type: none"> • Location with regards to existing employment areas and other sites • How the site fits into the overall portfolio 	<p>This site is an established and successful industrial estate located immediately to the east of Sutton Parkway Railway Station. The greenfield land to the north forms a green break between Sutton and Kirkby and the boundary between Sutton-in-Ashfield and Kirkby-in-Ashfield is approximately 100m north of this site.</p>	
<p>Local Plan Designation</p>	<p>The Ashfield Local Plan Review (November 2002) and the policies saved by the Secretary of State direction in 2007 comprise the development plan for Ashfield. The entire site is located within the main urban area (Policy ST2). Lowmoor Road adjacent to the site, is identified as a Nottinghamshire County Council Highways Scheme (Policy TR5 (2)).</p> <p>Land adjacent to and immediately north and east of the site is identified as Countryside (Policy EV2). Land immediately to the south of Sidings Road is allocated as Employment (Policy EM1) with Formal Open Space (Policy RC3) to the west. However, the site has since been identified for housing development in the Brownfield Land Register site ref. BFR13.</p>	
<p>Status in SHLAA</p>	<p>N/A</p>	
<p>Planning History</p>	<p>There are a number of previous planning applications associated with the employment uses onsite.</p>	
<p>Current Use and Land Type</p>	<p>This is a brownfield site occupied by an established industrial estate. There is a former landfill site adjacent to the western boundary and Lowmoor Road.</p>	
<p>Occupier Profile</p>	<p>The site is occupied by a range of employment uses including:</p>	

<p>(if partly developed, including % of available land and levels of vacancy onsite)</p>	<ul style="list-style-type: none"> • Store First • 100+ Logistics • Robinson Plastic Packaging • Charles Yorke Furniture • UK Home Shopping Tools-To-Go • Sanglier LTD – manufacturer of industrial adhesives, lubricants and paints • Nottingham Zinc Group • Kesseler Kitchens • Belwood Foods • S&P Casuals Limited • Brightwake Design, Development and Manufacturing • Merritts Machinery Logistics • GDC Specialist Drilling Contractor Limited • Kirkby Household Recycling Centre <p>In November 2020, there were a couple of units on the market as follows:</p> <ul style="list-style-type: none"> • A warehouse of 5,113 for sale (Unit 2, Sidings Road) • A warehouse of 6,646 sqm for sale (Unit 3, Byron Avenue) was also on the market and was advertised as under offer. <p>Outwith the site boundary but immediately adjacent to its southern extent, there is some 2.51 ha storage land with development potential known as 'The Sidings'. It was being advertised and was under offer in November 2020. The site has been identified for housing development in the Brownfield Land Register site ref. BFR13.</p>	
<p>Strategic Road Access</p>	<p>The site is approximately 900m from the A38 via Penny Emma Way. The site is approximately 2.7km from the A611 via Lowmoor Road and the B6020 and 5.8km from the M1 via the A38.</p>	<p>Poor</p>
<p>Local Road Access</p>	<p>The site can be accessed from Lowmoor Road to the western boundary Lowmoor Road. This provides access via Penny Emma Way to the A38. Both Lowmoor Road and Penny Emma Way are good free-moving roads.</p>	<p>Good</p>
<p>Proximity to Urban Areas and Access to Labour and Services (including public transport / cycling / walking accessibility)</p>	<p>The site is located between Sutton in Ashfield and Kirkby in Ashfield with easy access to the town's services, facilities and labour market. The Sutton Parkway Railway Station is located on the western side of Lowmoor Road, trains depart hourly to Nottingham and Worksop. Bus stops are also located on Lowmoor Road adjacent to the site with services running regularly to Kirkby, Sutton, Annesley, Ripley, Mansfield, Nottingham and</p>	<p>Very Good</p>

	Derby. There is a cycle route and footpath running along Lowmoor Road. Furthermore, Sutton-in-Ashfield Footpath 64 runs to the north of the site.	
Compatibility of Adjoining Uses (including amenity impacts experienced by current/future occupiers and neighbouring areas)	The site is bound by agricultural land to the north and east, residential properties to the south, and Lowmoor Road to the west with Sutton Parkway Railway Station and employment uses beyond.	Average
Developmental and Environmental Constraints (e.g. size; topography; site access; roads, lighting, landscaping, mains utilities and communications infrastructure; flood risk; contamination; nature and heritage conservation)	This is an established industrial estate with existing utilities and telecommunications infrastructure. The site is within Flood Zone 1 and therefore at low risk from flooding. Gas protection may be required as a result of the former landfill site adjacent. There are no known ground stability issues and the site is in a coal low-risk area. The site of Kirkby Hardwick Manor, a non-designated heritage asset, is approximately 200m to the west.	Average
Barriers to Delivery and Mitigation (including ownership constraints - if known)	The site is fully developed and no barriers to delivery were identified from the site visit.	Good
Market Attractiveness (including appropriateness, vacancy and market activity on site for the type of development proposed)	This is a large established industrial estate with low vacancy levels. It is in attractive location in close proximity of Sutton in Ashfield, Kirkby in Ashfield and the Vision West Nottinghamshire College Construction Campus, adjacent to the Sutton Parkway Railway Station and within 1km of the A38 trunk road.	Good
Strategic Fit with Growth Area Objectives (by target Market Segment)	This site already accommodates key industrial growth sectors as identified in the D2N2 Vision 2030 document including: <ul style="list-style-type: none"> • Logistics & E-Commerce • Retail • Construction • Food and drink manufacturing • Professional/business services 	Very Good
OVERALL SITE RATING	Good	
Recommendation and Potential Future Uses	Protect for employment uses – the boundary should include the entire employment area.	
SITE SUMMARY:		
This site is an established and successful industrial estate located immediately to the east of Sutton Parkway Railway Station. It is in attractive location in close proximity of Sutton in Ashfield, Kirkby in Ashfield and the Vision West Nottinghamshire College Construction Campus, adjacent to the Sutton Parkway Railway Station and within 1km of the A38 trunk road. A range of employment uses occupy the site as well as the Kirkby Household Recycling Centre. At the time of the site visit two units were on the market with one under offer. The site is within the urban area but is not currently		

allocated. It is recommended that the site be protected for employment uses to protect this valuable employment land and the existing uses onsite.

Oddicroft Lane (Ref: ADC4)



GROSS SITE AREA: 40.95 ha	ESTIMATED NET DEVELOPABLE AREA: 2.35 ha
--------------------------------------	--

CRITERIA	COMMENT	RATING
----------	---------	--------

<p>Site Context</p> <ul style="list-style-type: none"> • Location with regards to existing employment areas and other sites • How the site fits into the overall portfolio 	<p>This is a large established employment site which is intersected by the railway line and also accommodates the Vision West Nottinghamshire Engineering Innovation Centre and Construction Campus. The site is approximately 150m north of the Lowmoor Business Park.</p>	
---	---	--

<p>Local Plan Designation</p>	<p>The Ashfield Local Plan Review (November 2002) and the policies saved by the Secretary of State direction in 2007 comprise the development plan for Ashfield. The entire site is located within the main urban area (Policy ST2).</p> <p>Land adjacent to and immediately west of the A38 is allocated as Employment Land (EM1), land west of Oddicroft Lane and north of Penny Emma Way and Station Park off Julias Way is also allocated as employment land. There is also an area of Formal Open Space (Policy RC3) west of Oddicroft Lane.</p>	
--------------------------------------	---	--

<p>Status in SHLAA</p>	<p>The development plot adjacent to the A38 is identified in the 2015 Strategic Employment Land Availability Assessment (SELAA) (site ref. K3) as suitable for development for E, B2 and B8 uses with an extant planning permission. The site now occupied by DMW Logistics is also identified as being available for occupation (site ref. K6).</p>	
-------------------------------	--	--

<p>Planning History</p>	<p>There are a number of previous planning applications associated with the employment uses onsite. There is an unimplemented planning permission (ref. V/2008/0227) for the development of warehouse units falling within classes E (light industrial), B2 (general industrial) and B8 (warehousing and distribution at the vacant development</p>	
--------------------------------	---	--

	<p>site adjacent to the A38. A non-material amendment application (ref. V/2019/0075) has since been granted to allow the removal of a footpath to join together two units and for other minor design changes.</p>
<p>Current Use and Land Type</p>	<p>This is an established industrial estate with a range of employment uses and Vision West Nottinghamshire College Campuses. The railway line intersects the site from north to south with Sutton Parkway Station just to the south of the site. The River Maun also intersects the site adjacent to the railway line and there is an area of open space with footpaths adjacent to this.</p>
<p>Occupier Profile (if partly developed, including % of available land and levels of vacancy onsite)</p>	<p>This site accommodates the Vision West Nottinghamshire Engineering Innovation Centre and Construction Campus.</p> <p>Other occupiers include:</p> <ul style="list-style-type: none"> • Eurocell (building materials supplier) • DMW Logistics • Abacus (lighting manufacturer) • Celtic Technologies (environmental engineer) • Amazing Bathroom Supplies (bathroom supply store) • QX Bathroom Products (bathroom supply store) • ROMO (fabric wholesaler) • Crown Aerosols (manufacturer) • Boneham & Turner Ltd (engineer) • Paragon Customer Communications (professional/business services) <p>Station Park is located to the east of the railway line and accessed from Lowmoor Road then Julias Way. Occupiers here include Vision West Nottinghamshire College Construction Centre, Clothing Management Technology Ltd (clothing retail) and S&S Plastics Ltd (plastic injection moulding).</p> <p>In November 2020, there was one unit available to let, a warehouse of 2,538 sqm off Julias Way.</p> <p>There is also a development plot available in the western portion of the site adjacent to the A38. It comprises of up to 2.35 ha of land accessed from Penny Emma Way with a secondary access via a bridge over the A38 from Hardwick Lane. The site has an existing employment allocation and is suitable for a variety of uses, subject to planning permission. However, a historic planning permission was granted in 2008 (ref V/2008/0227) for the development of warehouse units falling within classes E (light industrial), B2 (general industrial) and B8 (warehousing and distribution).</p>

Strategic Road Access	<p>The site is adjacent to the A38 which provides access to Junction 28 of the M1 Motorway approximately 6km to the west and also to Mansfield and the A60 approximately 5.3km to the north east. The site is approximately 3.5km from the A611.</p>	Average
Local Road Access	<p>The site is adjacent to the A38 and is accessed via Penny Emma Way then Oddicroft Lane and Station Park is accessed via Lowmoor Road then Julias Way.</p>	Good
Proximity to Urban Areas and Access to Labour and Services (including public transport / cycling / walking accessibility)	<p>There are bus stops on Lowmoor Road with regular services to Kirkby in Ashfield, Sutton in Ashfield, Mansfield, Ripley, Nottingham and Derby. Sutton Parkway railway station is located immediately south of the site. There are footpaths intersecting the site from east to west and north to south, providing access to the employment uses from the surrounding residential areas.</p>	Very Good
Compatibility of Adjoining Uses (including amenity impacts experienced by current/future occupiers and neighbouring areas)	<p>The site is bound by residential properties and Ashfield District Council Trade Waste depot to the north, by Lowmoor Road to the east with countryside beyond, by Penny Emma Way with Sutton Parkway Railway Station and Pit Tip Park and Garden beyond, and by the A38 to the west with residential properties beyond.</p>	Average
Developmental and Environmental Constraints (e.g. size; topography; site access; roads, lighting, landscaping, mains utilities and communications infrastructure; flood risk; contamination; nature and heritage conservation)	<p>This is an established industrial estate with existing utilities and telecommunications infrastructure. The railway line and River Maun intersect the site from north to south. The site is within Flood Zone 1 and therefore at low risk from flooding. There are also a number of footpaths crossing the site. There is a telecoms mast off the eastern side of Oddicroft Lane. The site of Kirkby Hardwick Manor, a non-designated heritage asset, is approximately 50m to the south. There is the Kirkby Dismantled Railway Local Wildlife Site to the south of Penny Emma Way.</p>	Average
Barriers to Delivery and Mitigation (including ownership constraints - if known)	<p>The site is fully developed except for a development plot available in the western portion of the site adjacent to the A38. It comprises of up to 2.35 ha of land accessed from Penny Emma Way with a secondary access via a bridge over the A38 from Hardwick Lane. The site has existing employment allocation and is suitable for a variety of uses, subject to planning permission. Planning permission was granted in 2008 (ref V/2008/0227) for the development of warehouse units falling within classes E (light industrial), B2</p>	Good

	(general industrial) and B8 (warehousing and distribution).	
Market Attractiveness (including appropriateness, vacancy and market activity on site for the type of development proposed)	This is a large established employment area in an accessible location within Sutton in Ashfield. The site was fully occupied apart from one vacant unit in Station Park and a development plot adjacent to the A38.	Good
Strategic Fit with Growth Area Objectives (by target Market Segment)	This site already accommodates key industrial growth sectors as identified in the D2N2 Vision 2030 document including: <ul style="list-style-type: none"> • Logistics & E-Commerce • Transport Equipment Manufacturing • Retail • Professional/business services • Construction 	Very Good
OVERALL SITE RATING	Good	
Recommendation and Potential Future Uses	Allocate for employment uses – the undeveloped site should be allocated for employment uses with the remainder of the site protected for employment uses, this boundary should include the entire employment area.	
SITE SUMMARY:		
This is a large established employment site which is intersected by the railway line and accommodates a range of employment uses as well as the Vision West Nottinghamshire Engineering Innovation Centre and Construction Campus. It is within Sutton in Ashfield and adjacent to the A38 and Sutton Parkway Railway Station. The site is fully developed except for a development plot available in the western portion of the site adjacent to the A38 comprising of up to 2.35 ha of land which is allocated for employment and has a historic permission for employment uses. There was only one vacant unit at the time of the site visit. Multiple plots within the site are allocated for employment and it is recommended that the entire site is allocated for employment uses.		

Sherwood Business Park (Ref: ADC5)



**GROSS SITE AREA:
85.08 ha**

**ESTIMATED NET DEVELOPABLE
AREA:
0 ha**

CRITERIA	COMMENT	RATING
<p>Site Context</p> <ul style="list-style-type: none"> • Location with regards to existing employment areas and other sites • How the site fits into the overall portfolio 	<p>This is a well-established and very successful business park adjacent to the A608 and A611 and within 750m of Junction 27 of the M1 Motorway. It is one of the largest employment sites in the District and accommodates a cross-section of small start-up businesses and multi-national companies across a range of sectors including technology, manufacturing, engineering, logistics and healthcare. Kodak were the originators of the business park in the early 1990s, the plant subsequently closed in 2013 and the site was integrated with the business park. The site was established as an Enterprise Zone in 1995.</p>	
<p>Local Plan Designation</p>	<p>The Ashfield Local Plan Review (November 2002) and the policies saved by the Secretary of State direction in 2007 comprise the development plan for Ashfield. The site is outside of the main urban area (Policy ST2). The north-eastern portion of the site and two areas within the southern portion of the site are allocated for employment uses (Policy EM1Rb). The southern portion of the site is also within a Historic Park and Garden (Policy EV14Ra). A Mature Landscape Area (Policy EV4) and Nature Conservation Site (Policy EV6) bound the site to the west. Green Belt land encircles the site.</p>	
<p>Status in SHLAA</p>	<p>The land to the south of the business park and west of Willow Drive is identified in the 2015 Strategic Employment Land Availability Assessment (SELAA) (site ref. K11). The site</p>	

	could provide employment space subject to demonstrating exceptional circumstances for removal from the Green Belt.
Planning History	There are a number of previous planning applications associated with the employment uses onsite.
Current Use and Land Type	This is a brownfield site occupied by an established business park. There is extensive landscaping across the site and multiple drainage ponds.
Occupier Profile (if partly developed, including % of available land and levels of vacancy onsite)	<p>The site is occupied by a range of uses from manufacturing, technology, logistics, public sector and charities to serviced office space and a hotel. Occupiers include:</p> <ul style="list-style-type: none"> • NHS Supply Chain • Highways England • Multi-Agency Safeguarding Hub (MASH) • Nottinghamshire County Council Customer Service Centre • TTS (education supplies distributor) • Eon (electricity supplier) • Countrywide Lettings (property services) • Adare Sec (communications) • Interserve Healthcare (nursing agency) • Icon Business Centre • Pure Offices – serviced offices • L'Oréal (cosmetics manufacturer) • Autofil (yarn manufacturer) • Dell Technologies • DXC Technology • Infosys (technology services) • Cotton Trader (clothing fulfilment centre) • Prolog Fulfilment Ltd (logistics) • Eddie Stobart (logistics) • Pendragon PLC (vehicle retail and technology) • Turbine Surface Technologies Ltd (aviation manufacturing) • Rolls Royce Annesley Factory (<i>note: In August 2020 Rolls Royce announced that this site is due to close. It was still in operation at the time of the site visit in November 2020</i>) • SMPE Standard Motor Products Europe • Parkside Steel (steel distributors) • SPS Aerostructures (aviation manufacturing) • Zeppelin Systems (mechanical engineering) • Design & Analysis Ltd (engineering design and analysis) <p>Non-employment uses include:</p> <ul style="list-style-type: none"> • Mour Hotel • Kodak Fishing Lakes • Lakeside Café <p>There were the following vacant units in November 2020:</p>

	<ul style="list-style-type: none"> • Evolution 27, also known as Chadwick House - 20,199 sqm of HQ office and warehousing/industrial space. • 80 Sherwood – 7,394 sqm warehouse (formerly occupied by Prolog) • 1 Oakwood Court - three suits available totalling 1,763 sqm office space • Loxley House – 4,164 sqm office space • Evo Pods Office and warehouse space Pod 1 – 1,157 sqm, Pod 2 – 1,156 sqm, Pod 4 – 1,153 sqm, Pod 8 – 1,190 sqm) • Waterfront House, Lakeside Court - a range of office units available • The Portal – a range of office units available • COMO, Lakeview Drive – a range of office units available 	
Strategic Road Access	The site is adjacent to the A608 Mansfield Road and A611 Derby Road. The site is within 750m of Junction 27 of the M1 motorway via the A608.	Very Good
Local Road Access	The site is accessed via the spine roads Osier Drive and Willow Drive from the A608	Very Good
Proximity to Urban Areas and Access to Labour and Services (including public transport / cycling / walking accessibility)	<p>The nearest urban areas are Annesley and Annesley Woodhouse approximately 300m to the north. There are multiple bus stops located within the site with regular services to Mansfield, Nottingham and Derby. There is a cycle route from Sherwood Business Park through Annesley and north to Kirkby and Sutton.</p> <p>Public Footpaths intersect the site from north to south and east to west providing access around the site, to the urban areas to the north and the surrounding countryside and roads.</p>	Average
Compatibility of Adjoining Uses (including amenity impacts experienced by current/future occupiers and neighbouring areas)	The site is bound by woodland 'Little Oak Plantation' to the north with Annesley and Annesley Woodhouse beyond, by Annesley Road (A611) to the east with Annesley Forest beyond, by Mansfield Road (A608) to the south with agricultural land beyond and by agricultural land to the west with greenfield land beyond.	Very Good
Developmental and Environmental Constraints (e.g. size; topography; site access; roads, lighting, landscaping, mains utilities and communications infrastructure; flood risk; contamination; nature and heritage conservation)	Davis's Bottom and Davis's Bottom Grassland Local Wildlife Site are adjacent to the western boundary of the site. Land to the west of the site is identified as 'good quality semi-improved grassland' and 'broadleaved deciduous woodland'. Local Wildlife Site Annesley Forest is located to the east of the A611 and Little Oak Plantation Local Wildlife Site and Local Heritage List nominated site is adjacent to the northern	Average

	<p>boundary of the site. There are mature trees across the site and multiple drainage ponds including two fishing lakes off Lake View Drive. The site is within Flood Zone 1 and therefore at a low risk of flooding. There are some level changes particularly in the southern portion of the site.</p> <p>A Scheduled Ancient Monument (Fishponds 170m south of Damstead Farm – List Entry Number - 1018119) is located approximately 250 m to the west of the site.</p> <p>Annesley Hall Registered Park and Gardens (Grade II* - List Entry Number: 1001077) is located immediately south of the site and includes a small area of the site. There are various listed buildings and scheduled monuments within this area including:</p> <ul style="list-style-type: none"> • Annesley Hall (Grade II Listed – List Entry Number: 1234836); • Terrace to the south west of Annesley Hall (Grade II Listed - List Entry Number: 1234839); • Gatehouse Range at Annesley Hall (Grade II Listed – List Entry Number: 1234843); • Annesley Lodge (Grade II Listed – List Entry Number: 1234846); • Scheduled Monument All Saints Church and graveyard (List Entry Number: 1020778); and • Scheduled monument Annesley motte and bailey castle (List Entry Number: 1009305). <p>There is also the Grade II* Listed Church of All Saints located approximately 500m north east of the site.</p>	
<p>Barriers to Delivery and Mitigation (including ownership constraints - if known)</p>	<p>The site is fully developed and surrounded by Green Belt. There are Local Wildlife Sites adjacent so any potential development would need to assess and mitigate impacts upon biodiversity. Furthermore, the potential harm to the significance of Damstead Farm Fishponds and Annesley Hall Registered Park and Garden heritage assets would need to be assessed.</p>	<p>Good</p>
<p>Market Attractiveness (including appropriateness, vacancy and market activity on site for the type of development proposed)</p>	<p>This is an established and successful business park, in an attractive location adjacent to Junction 27 of the M1.</p>	<p>Very Good</p>
<p>Strategic Fit with Growth Area Objectives (by target Market Segment)</p>	<p>In view of the accessible location of the site from the M1 and nearby urban areas, this site is well-placed to accommodate key industrial sectors targeted by D2N2 and contribute to growth objectives, particularly transport, manufacturing,</p>	<p>Very Good</p>

	logistics, healthcare, professional/business services and creative/digital.	
OVERALL SITE RATING	Very Good	
Recommendation and Potential Future Uses	Protect for employment uses – the boundary should include the whole Sherwood Business Park including the existing employment allocations.	
SITE SUMMARY:		
<p>This is an established and successful business park adjacent to the A608 and A611 and within 750m of Junction 27 of the M1 Motorway. It is one of the largest employment sites in the district and accommodates a cross-section of small start-up businesses and multi-national companies across a range of sectors including technology, manufacturing, engineering, logistics and healthcare. There were two substantial warehouse units vacant and a number of vacant office units at the time of the site visit. The site is outside of the main urban area and areas of the site are allocated for employment uses, Green Belt land encircles the site. There are a number of landscape and heritage designations within close proximity of the site. It is recommended that the whole site be protected for employment uses.</p>		

Park Lane Business Park (Ref: ADC6)



**GROSS SITE AREA:
10.35 ha**

**ESTIMATED NET DEVELOPABLE AREA:
1.2 ha**

(Note: comprising of the northern portion of the site with unimplemented permission for a garage and workshop (0.35ha) and the storage land in the east of the site (0.85ha) which is potentially available)

CRITERIA	COMMENT	RATING
<p>Site Context</p> <ul style="list-style-type: none"> • Location with regards to existing employment areas and other sites • How the site fits into the overall portfolio 	<p>This site is an established business park located on the former Bentinck Colliery site approximately 1.3km south of Kirkby in Ashfield. It is occupied by industrial and commercial uses including Collins Earthworks and Julian Bowen furniture wholesaler, there are also a number of smaller workshop units. This site meets more localised demand for employment land.</p>	
<p>Local Plan Designation</p>	<p>The Ashfield Local Plan Review (November 2002) and the policies saved by the Secretary of State direction in 2007 comprise the development plan for Ashfield. The northern half of the site is allocated as an employment site of 6.5ha (Policy EM1) with the southern identified as Countryside (Policy EV2). The site lies outwith the main urban area of Kirkby in Ashfield and Green Belt borders wraps around the site to the east and south.</p>	
<p>Status in SHLAA</p>	<p>The vacant development plot in the north of the site is identified in the 2015 Strategic Employment Land Availability Assessment (SELAA) (site ref. K5) as available for occupation. This also includes the site east of the Julian Bowen unit which is in use as storage for Collin's Earthworks and the new speculative B2 unit to the south of this.</p>	

<p>Planning History</p>	<p>Following the closure of Bentinck Colliery, outline planning permission (ref. V/2002/0429) was granted in 2003 for creation of a business park for B1, B2 and B8 uses on the site, with a total site area of 12.32 ha.</p> <p>There are a number of determined planning applications in relation to the business park uses which have been implemented. Most recently, full planning permission (ref. v/2019/0677) was granted for an industrial unit (2,612 sqm of B2 industrial warehouse space) on Plot 7B adjacent to the Ezi-dock and Auto 4 units. This plot was previously in use as temporary storage. This plot was developed speculatively and development is almost complete. There is also a retrospective application (ref. V/2020/0854) pending determination for a portable building at Unit 2b (to the east of the Julian Bowen unit and north of the new B2 unit) associated with the Collin's Earthworks operations.</p> <p>Outline planning permission (ref. V/2003/0520) was granted in 2003 for a Coach Garage and Coach Repair Shop in the northern portion of the site and east of BSC Auto Services. However, this was not implemented. In 2007, full planning permission (ref. V/007/0120) was then granted for a Garage and Workshop on this site however, this has not been implemented and the site remains vacant. This site equates to approximately 0.35ha.</p>	
<p>Current Use and Land Type</p>	<p>This is a former colliery site currently in use as a business park.</p>	
<p>Occupier Profile (if partly developed, including % of available land and levels of vacancy onsite)</p>	<p>The main occupiers of the business park are Collins Earthworks (aggregate recycling) and Collins Transport, Julian Bowen (furniture wholesaler), Burrows Brothers (suppliers to the mining and tunnelling industry), Truss-Tech (rafters and beams manufacturer) and RM Resources (educational resources provider). There are also a number of smaller workshop units housing a range of businesses including Diamond Driver Training, Ezi-dock (packaging) and Auto 4 (vehicle parts).</p> <p>No vacant units were noted at the time of the site visit (November 2020).</p> <p>There is a small undeveloped area within the north of the site comprising of approximately 0.35ha with historic permission for garages/workshops.</p> <p>There is also an area to the east of the site comprising of approximately 0.85ha which is currently in use as storage for Collins Earthworks, it is understood from discussions with the site developer that this area is potentially available for development.</p>	
<p>Strategic Road Access</p>	<p>The site is approximately 2.7km south of the A38 via Park Lane and 3.5km west of the A611. It is</p>	<p>Very Poor</p>

	within 5km of Junction 28 of the M1 via Park Lane and the A38 or via Pinxton Lane.	
Local Road Access	The site can be accessed via Park Lane (B6018). Park Lane provides access to the A38 to the north however, it passes through residential areas and close to a school. There is also a bridge approximately 100m south of the site entrance which can accommodate vehicles with a maximum height of 4.4m. This bridge provides access to the site from the agricultural land to the west.	Poor
Proximity to Urban Areas and Access to Labour and Services (including public transport / cycling / walking accessibility)	The site is approximately 1.3km south from Kirkby in Ashfield. There are bus stops on Park Lane with regular services to Sutton in Ashfield, Mansfield, Derby, Ripley and Alfreton. Kirkby in Ashfield provides a local labour market and services including schools, supermarkets, local shops and medical facilities. Kirkby in Ashfield railway station is approximately 2.4km from the site.	Good/ Average
Compatibility of Adjoining Uses (including amenity impacts experienced by current/future occupiers and neighbouring areas)	The site is bound by a vehicle servicing centre and established woodland to the north with greenfield land beyond, by Mill Lane to the east with greenfield land beyond, by woodland to the south, by Park Lane to the west and a Sewage Treatment Works and Spring Meadow Private Park for travelling showpeople beyond. The Green Belt wraps around the site to the east and south.	Average
Developmental and Environmental Constraints (e.g. size; topography; site access; roads, lighting, landscaping, mains utilities and communications infrastructure; flood risk; contamination; nature and heritage conservation)	This is a former colliery site currently occupied by industrial uses with existing utilities and communications infrastructure. It is accessed from Park Lane. The site is within Flood Zone 1 and therefore at low risk from flooding. The site is within an SSSI Impact Risk Zone as the Kirkby Grives SSSI is approximately 400m to the south east of the site, Annesley Woodhouse Quarries SSSI is also approximately 700m south of the site. Bentinck Colliery Local Wildlife Site (LWS) is located immediately south of the site, Kirkby Bentinck Colliery and Dismantled Railway LWS's to the east. Kirkby Mill (site ref. 284) locally listed heritage asset is to the south east of the site.	Average
Barriers to Delivery and Mitigation (including ownership constraints - if known)	The site is fully occupied except for a plot of approximately 0.35ha off the northern access road to the east of BSC Vehicle Services and the area of land used for storage for Collins Earthworks (approximately 0.85ha) to the east of the site which is potentially available.	Average
Market Attractiveness (including appropriateness,	This is an established business park in close proximity to Kirkby in Ashfield; however, access to	Average

vacancy and market activity on site for the type of development proposed)	the site is through constrained residential roads. At the time of the site visit there were no vacant units. A new industrial warehouse unit of 2,612 sqm is almost complete on Plot 7B, this plot was previously in use as temporary storage and has been developed speculatively.	
Strategic Fit with Growth Area Objectives (by target Market Segment)	This site serves a local employment land need and has the potential to accommodate key industrial growth sectors as identified in the D2N2 Vision 2030 document including: <ul style="list-style-type: none"> • Transport Equipment Manufacturing • Food & Drink Manufacturing • Logistics & E-Commerce • Construction 	Average
OVERALL SITE RATING	Average	
Recommendation and Potential Future Uses	Allocate for employment uses - the undeveloped land should be allocated for employment uses with the remainder protected for employment uses, the boundary should include the whole Park Lane Business Park site	
SITE SUMMARY:		
<p>This site is an established business park located on the former Bentinck Colliery site approximately 1.3km south of Kirkby in Ashfield. It is occupied by industrial and commercial uses including Collins Earthworks (aggregate recycling), Burrows Brothers (suppliers to the mining and tunnelling industry) and Julian Bowen (furniture wholesaler). There are also a number of smaller workshop units. Local access to the site is via constrained roads through residential areas. The site is also within close proximity of multiple SSSI's.</p> <p>The site is fully occupied with the exception of a vacant plot to the north of approximately 0.35ha for which previous planning permissions have not been implemented and the area of land used for storage for Collins Earthworks to the east of the site which is potentially available for development and comprises of approximately 0.85ha.</p> <p>It is recommended that the undeveloped land should be allocated for employment uses with the remainder protected for employment uses, the boundary should include the whole Park Lane Business Park site. This is to protect the existing employment uses on this established business park.</p>		

The County Estate Nunn Brook Road/Brookside Way (Ref: ADC7)



GROSS SITE AREA:
52.88 ha

ESTIMATED NET DEVELOPABLE AREA:
0 ha

CRITERIA	COMMENT	RATING
<p>Site Context</p> <ul style="list-style-type: none"> • Location with regards to existing employment areas and other sites • How the site fits into the overall portfolio 	<p>This site is a large industrial estate in the established and popular Huthwaite Industrial area, it is adjacent to Fulwood Industrial Park and within close proximity of Junction 28 of the M1 motorway. The boundary between Bolsover, Derbyshire and Ashfield, Nottinghamshire adjoins the western boundary of the site.</p>	
<p>Local Plan Designation</p>	<p>The Ashfield Local Plan Review (November 2002) and the policies saved by the Secretary of State direction in 2007 comprise the development plan for Ashfield. The entire site is located within the main urban area (Policy ST2). A portion of the site south of Blackwell Road and east of Nunn Brook Road is allocated for employment uses (Policy EM1). Areas of land adjoining Brookside Way to the south are also allocated for employment uses (Policy EM1). There are also a couple of Nature Conservation sites (Policy EV6) located off Nunn Brook Road and also Brookside Way.</p>	
<p>Status in SHLAA</p>	<p>N/A</p>	
<p>Planning History</p>	<p>There are a number of previous planning applications associated with the employment uses onsite.</p>	
<p>Current Use and Land Type</p>	<p>This site is an established industrial estate within the wider industrial area of Huthwaite and adjacent to Fulwood Industrial Park.</p>	
<p>Occupier Profile (if partly developed, including % of available land and levels of vacancy)</p>	<p>The site is fully developed and occupied by a range of employment uses including:</p> <ul style="list-style-type: none"> • Swiftool Precision Engineering 	

onsite)	<ul style="list-style-type: none"> • DPD Nottingham Depot • ASD Wholesale (drinks distributor) • Taylors Transport International • Performance Health (manufacturer and distributor of healthcare products) • SR Timber (roofing supply store) • Advatac (adhesives manufacturer) • Reader Cement Products • Jet Press (manufacturer of fastening products and components) • NMCN (water and built environment contractor) • Fresenius Medical Care (healthcare products manufacturer and distributor) <p>There are also number of smaller workshop units located in Prospect Court, off Nunn Close. In the northern corner of the site, heading west along Blackwell Road there are a couple of residential dwellings and a pet boarding kennels.</p> <p>There were low vacancy levels during the time of the site visit, with only 5 units on the market in November 2020. These are discussed in the market attractiveness section below.</p>	
Strategic Road Access	The site is approximately 1km north of the A38 via Common Road. The A38 provides access to Junction 28 of the M1 motorway which is approximately 3km away.	Poor
Local Road Access	The site can be accessed from Common Road (B6027) which is a good free-moving road heading south to the A38, it is more constrained heading north to Huthwaite as it passes through residential areas and past a school. Industrial units are located off Brookside Way which is a cul-de-sac. The majority of units are located on Nunn Brook Road which provides through access from Common Road to Blackwell Road (B6026) to the north. Common Road provides access to the A38 approximately 1km to the south. Nunn Brook Rise and Nunn Brook Close branch off from Nunn Brook Road.	Good
Proximity to Urban Areas and Access to Labour and Services (including public transport / cycling / walking accessibility)	The site is located within Huthwaite and is approximately 4km west of Sutton in Ashfield. Huthwaite is a village and provides a more limited range of services including small convenience stores, primary schools, a medical centre and local shops. Sutton in Ashfield provides a wider range of facilities and services. Sutton Parkway railway station is approximately 4.8km from the site via the A38. There are bus stops on Common Road	Good

	adjacent to the site with regular services to Mansfield, Mansfield Woodhouse, Alfreton and South Normanton. The Blackwell Trail footpath intersects the site from east to west, north of Brookside Way.	
Compatibility of Adjoining Uses (including amenity impacts experienced by current/future occupiers and neighbouring areas)	The site is bound by Blackwell Road to the north with greenfield land beyond, by Huthwaite's residential areas and Common Road to the east, by Nunn Brook and the Fulwood Industrial Estate to the south and by agricultural land to the west. There are mature treelines which act as buffers from the residential areas to the north/east and the agricultural land to the west, also along Nunn Brook to the south.	Average / Good
Developmental and Environmental Constraints (e.g. size; topography; site access; roads, lighting, landscaping, mains utilities and communications infrastructure; flood risk; contamination; nature and heritage conservation)	<p>This is a large relatively level site within an established industrial area with existing utilities and communications infrastructure. The site is within Flood Zone 1 and therefore at low risk from flooding, except for a narrow strip along Nunn Brook to the south which is within Flood Zone 3 and therefore at a high risk of flooding. There are no heritage assets within or adjacent to the site.</p> <p>There are a number of Local Wildlife Sites (LWS) to the south of the site:</p> <ul style="list-style-type: none"> • Hucknall Disused Railways; • New Hucknall Sidings Grasslands; • Hucknall Disused Railway (intersects the site east to west); and • Huthwaite Commons Industrial Estate LWS is adjacent to the former data centre. 	Good
Barriers to Delivery and Mitigation (including ownership constraints - if known)	The site is fully developed. No barriers to future redevelopment were apparent from the site visit.	Good
Market Attractiveness (including appropriateness, vacancy and market activity on site for the type of development proposed)	<p>The site is in an established industrial area in close proximity to the labour market and services of both Huthwaite and Sutton in Ashfield and with good access to the A38 and Junction 28 of the M1 Motorway. It is a popular industrial estate with a relatively low level of vacancies.</p> <p>The following units were on the market in November 2020:</p> <ul style="list-style-type: none"> • A warehouse of up to 1,271 sqm with a yard of 0.2 ha which could be subdivided into two units on Fulwood Place off Brookside Way. • A refurbished distribution warehouse of 4,848 sqm on a site of 1.1ham located on Brookside 	Good

	<p>Way.</p> <ul style="list-style-type: none"> • A former data centre comprising of offices and data centre accommodation on a site of 2.55 ha located on Nunn Brook Rise off Nunn Brook Road. It was being advertised as a development opportunity for alternative employment uses subject to planning. • Hill House located at the northern end of Nunn Brook Road, was being advertised for sale via auction. It comprises of a detached industrial unit with adjoining workshop with a total GIA of 602 sqm on a site of 0.15 ha. It was formerly in use as a training centre. • A warehouse and detached office building totalling 4,331 sqm located on Nunn Brook Road was being advertised as a Head Quarters opportunity for sale or to let. 	
Strategic Fit with Growth Area Objectives (by target Market Segment)	<p>This site already accommodates key industrial growth sectors as identified in the D2N2 Vision 2030 document and has the potential to accommodate additional businesses within these sectors. Key sectors already accommodated on the site include:</p> <ul style="list-style-type: none"> • Construction • Logistics & E-Commerce • Transport Equipment Manufacturing • Food & Drink Manufacturing • Health/Social Care 	Good
OVERALL SITE RATING	Good	
Recommendation and Potential Future Uses	Protect for employment uses – the boundary should include the whole County Estate Nunn Brook Road/Brookside Way industrial estate.	
SITE SUMMARY:		
<p>This is a large industrial estate in the established and popular Huthwaite Industrial area, within close proximity of Junction 28 of the M1 motorway via Common Road and the A38. The site adjoins the boundary between Bolsover and Ashfield Authorities to the west, Huthwaite residential area to the east and Fulwood Industrial Park to the south. The site is fully developed and occupied by a range of employment uses primarily in the construction, logistics, transport, food/drink and health manufacturing sectors. The site is popular and there was a low level of vacancies. It is considered that the whole estate should be protected for employment uses to protect the uses currently onsite and this important local employment area.</p>		

Calladine Business Park (Ref: ADC8)



**GROSS SITE AREA:
15.60 ha**

**ESTIMATED NET DEVELOPABLE
AREA:
0 ha**

CRITERIA	COMMENT	RATING
<p>Site Context</p> <ul style="list-style-type: none"> • Location with regards to existing employment areas and other sites • How the site fits into the overall portfolio 	<p>This site is an established business park located on the southern periphery of Sutton in Ashfield adjacent to the A38. The site is approximately 1km east of the established Huthwaite Industrial Area.</p>	
<p>Local Plan Designation</p>	<p>The Ashfield Local Plan Review (November 2002) and the policies saved by the Secretary of State direction in 2007 comprise the development plan for Ashfield. The entire site is located within the main urban area (Policy ST2).</p> <p>There is allocated housing land (Policy H1) immediately to the west of the site adjacent to the A38, this site has not yet been developed. There is an area of Formal Open Space (Policy RC3) to the north of the site and Housing Land (Policy H1) to the north and east of the site.</p> <p>To the south of the site on the southern side of the A38, there is the boundary for the main urban area; beyond this there is Countryside (Policy EV2), Mature Landscape Area (Policy EV4), Nature Conservation Site (Policy EV6) and Bloomer Wood Ancient Woodland (Policy EV8).</p>	
<p>Status in SHLAA</p>	<p>N/A</p>	
<p>Planning History</p>	<p>There are a number of previous planning applications associated with the employment uses onsite.</p>	
<p>Current Use and Land Type</p>	<p>This is an established industrial estate.</p>	
<p>Occupier Profile (if partly developed, including % of</p>	<p>The site is fully developed and occupied by a range of employment uses, primarily in the manufacturing sector</p>	

<p>available land and levels of vacancy onsite)</p>	<p>including:</p> <ul style="list-style-type: none"> • Konica Minolta (manufacturer of printers) • Meridian (manufacturer of transportation parts) • White Meadow (manufacturer of furniture) • Crystal Martin Ltd (manufacturer of clothes and fabric) • Retail Packaging Solutions (manufacturer of packaging) • Bunzl Catering Supplies (catering supplies distributor) • Kuehne + Nagel (logistics) • Availablecar.com (vehicle sales) <p>In November 2020 there was one unit available to let, a warehouse of 11,162 sqm.</p>	
<p>Strategic Road Access</p>	<p>The site is adjacent to the A38 and approximately 3.3km from Junction 28 of the M1 via the A38. The A38 also connects with Mansfield and the A60 approximately 7km to the east.</p>	<p>Average</p>
<p>Local Road Access</p>	<p>The site is accessed via Orchard Way from the A38 Kings Mill Road East to the south. The A38 is a good free-moving road. The B6023 connects the site to Sutton in Ashfield to the North and the B6018 connects to Kirkby in Ashfield to the south.</p>	<p>Very Good</p>
<p>Proximity to Urban Areas and Access to Labour and Services (including public transport / cycling / walking accessibility)</p>	<p>The site is adjacent to the residential areas of Sutton in Ashfield and approximately 3km from the centre of Sutton in Ashfield and 2.5km from the centre of Kirkby in Ashfield. Both towns provide a good range of facilities and services including convenience and comparison retail, education and medical facilities as well as a local labour market. The A38 provides easy access to Sutton Parkway Railway Station, approximately 2.5km to the east. Kirkby in Ashfield Railway Station is approximately 3.5km south east of the site. The nearest bus stops are on Alfreton Road, there are regular services from here connecting Kirkby in Ashfield, Sutton in Ashfield, Mansfield, Derby and Alfreton. A footpath intersects the site east to west, linking Alfreton Road to the west, to a pedestrian bridge over the A38 to the south and the residential area to the east of the site. A footpath also connects Orchard Way with the residential area to the north.</p>	<p>Good</p>
<p>Compatibility of Adjoining Uses (including amenity impacts experienced by current/future occupiers and neighbouring areas)</p>	<p>The site is bound to the north by a formal recreation space and residential properties, to the east by residential properties, to the south by the A38 with countryside beyond and to the west by undeveloped housing land, existing residential properties and Alfreton Road beyond.</p>	<p>Average</p>

	There is landscaping and mature trees along the site boundaries which act as a good buffer between the employment uses on the site and neighbouring uses.	
Developmental and Environmental Constraints (e.g. size; topography; site access; roads, lighting, landscaping, mains utilities and communications infrastructure; flood risk; contamination; nature and heritage conservation)	This is a large relatively level site with existing utilities and communications infrastructure. The site is within Flood Zone 1 and therefore at low risk from flooding. There is the Grade II Listed Fulwood Farmhouse (listing ref. 1234876) adjacent to the site off Fonton Hall Drive. A footpath intersects the site east to west, linking Alfreton Road to the west, to a pedestrian bridge over the A38 to the south and the residential area to the east of the site. A footpath also connects Orchard Way with the residential area to the north. To the south of the A38 there is the Ashfield District By-pass Meadows Local Wildlife Site.	Average / Good
Barriers to Delivery and Mitigation (including ownership constraints - if known)	The site is fully developed. No barriers to redevelopment were apparent from the site visit.	Good
Market Attractiveness (including appropriateness, vacancy and market activity on site for the type of development proposed)	This is an established and relatively modern industrial estate in an accessible location in close proximity to Sutton in Ashfield, Kirkby in Ashfield and the M1 Motorway. All units were occupied with only one on the market at the time of the site visit.	Good
Strategic Fit with Growth Area Objectives (by target Market Segment)	This site already accommodates key industrial growth sectors as identified in the D2N2 Vision 2030 document including: <ul style="list-style-type: none"> • Logistics & E-Commerce • Transport Equipment Manufacturing • Retail 	Good
OVERALL SITE RATING	Good	
Recommendation and Potential Future Uses	Protect for employment uses.	
SITE SUMMARY:		
<p>This site is an established business park located on the southern periphery of Sutton in Ashfield adjacent to the A38. The site is approximately 1km east of the established Huthwaite Industrial Area and within 3.3km of Junction 28 of the M1 Motorway. There are a range of manufacturing and logistics occupiers on the site and all units were occupied, albeit one warehouse was also being advertised to let. The site is within the main urban area but is not currently allocated for employment uses. It is recommended that the site be protected for employment uses to protect this employment area and the existing uses on the site.</p>		

Hamilton Road (Ref: ADC9)



GROSS SITE AREA:
3.88 ha

ESTIMATED NET DEVELOPABLE AREA:
0 ha

CRITERIA	COMMENT	RATING
<p>Site Context</p> <ul style="list-style-type: none"> • Location with regards to existing employment areas and other sites • How the site fits into the overall portfolio 	<p>The site is a small and relatively modern business park located within the Main Urban Area of Sutton in Ashfield within 350m of the A617 and A38. The site is approximately 500m west of Summit Park and 800m west of the Hermitage Lane Industrial Area. It is approximately 1.5km north of the Oddicroft Lane and Lowmoor Industrial Estates. Whilst not within the site boundary, there is a larger employment area adjoining the site off Coxmoor Road.</p>	
<p>Local Plan Designation</p>	<p>The Ashfield Local Plan Review (November 2002) and the policies saved by the Secretary of State direction in 2007 comprise the development plan for Ashfield. The entire site is located within the main urban area (Policy ST2) and is allocated as Employment Land (Policy EM1). The boundary of the main urban area wraps around the site to the east and south with identified Countryside (Policy EV2) and Mature Landscape Area (Policy EV4) beyond. The adjacent employment land is not allocated.</p>	
<p>Status in SHLAA</p>	<p>N/A</p>	
<p>Planning History</p>	<p>There are a number of previous planning applications associated with the employment uses onsite.</p>	
<p>Current Use and Land Type</p>	<p>This is a brownfield site occupied by employment uses.</p>	
<p>Occupier Profile (if partly developed, including % of available land and levels of vacancy onsite)</p>	<p>All units were occupied and there are a range of employment uses including research and development and manufacturing:</p> <ul style="list-style-type: none"> • Quickits Limited Engineering (precision engineering) • Laser Fabrications (laser cutting) 	

	<ul style="list-style-type: none"> • Deep Sea Electronics (electronics and software design) • Maun Industries (tool manufacturer) • Hamilton Road Garage (vehicle sales) • R&D Leverage (tool manufacturer) • Nice Home Automation (technology manufacturer) 	
Strategic Road Access	The site is within 350m of both the A617 and the A38. The A38 provides access to junction 28 of the M1 motorway approximately 7km from the site. The site is also within 2.5km of the A611.	Poor
Local Road Access	The site is accessed from two spine roads coming off Hamilton Road. Hamilton Road is a good free-moving road heading east to the A617. Coxmoor Road joins Hamilton Road and connects with the A38. There is a level crossing on Coxmoor Road prior to joining the A38.	Average
Proximity to Urban Areas and Access to Labour and Services (including public transport / cycling / walking accessibility)	The site is located on the outskirts of Sutton in Ashfield. There are limited bus services within close proximity of the site. There was a bus stop on Hamilton Road which did not appear to be in use and there is a bus stop on Coxmoor Road with a once daily service serving Kirkby in Ashfield and Annesley. Sutton Parkway Railway Station is approximately 1.7km south of the site.	Average
Compatibility of Adjoining Uses (including amenity impacts experienced by current/future occupiers and neighbouring areas)	The site is bound to north by the railway line and employment uses/countryside and the A617 beyond, to the east by countryside and the A617 beyond, to the south by Hamilton Road and countryside beyond, to the west by Coxmoor Road and employment uses beyond.	Very Good
Developmental and Environmental Constraints (e.g. size; topography; site access; roads, lighting, landscaping, mains utilities and communications infrastructure; flood risk; contamination; nature and heritage conservation)	This is a small level site with utilities and communications infrastructure in place. It is within Flood Zone 1 and therefore at low risk of flooding. There is a scheduled monument – Mound on Hamilton Hill (ref. 1002921) approximately 350 m east of the site.	Average
Barriers to Delivery and Mitigation (including ownership constraints - if known)	The site is fully developed and no potential developmental constraints were apparent during the site visit	Good
Market Attractiveness (including appropriateness, vacancy and market activity on site)	This is a small site within a wider industrial area with frontage onto Hamilton Road. It is a relatively modern business park and the units are in good	Average / Good

for the type of development proposed)	condition. There were no vacancies at the time of the site visit.	
Strategic Fit with Growth Area Objectives (by target Market Segment)	This site already accommodates key industrial growth sectors as identified in the D2N2 Vision 2030 document including: <ul style="list-style-type: none"> • Transport Equipment Manufacturing • Creative & Digital • Professional/business services 	Good
OVERALL SITE RATING	Average	
Recommendation and Potential Future Uses	Protect for employment uses (i.e. retain current employment designation)	
SITE SUMMARY:		
<p>The site is a small and relatively modern business park located on the south-west periphery of Mansfield within 350m of the A617 and A38. It is set within a wider employment area and is within close proximity of Summit Park and Hermitage Lane Industrial Areas. A number of research and development and manufacturing businesses are located here and the site was fully occupied. The site is currently designated for employment uses and it is recommended that this employment protection is retained.</p>		

Common Road, Industrial Estate, Export Drive (Ref: ADC10)



**GROSS SITE AREA:
34.92 ha**

**ESTIMATED NET DEVELOPABLE
AREA:
5.7 ha**

CRITERIA	COMMENT	RATING
<p>Site Context</p> <ul style="list-style-type: none"> • Location with regards to existing employment areas and other sites • How the site fits into the overall portfolio 	<p>This site is a large industrial estate in the established and popular Huthwaite Industrial area, it is adjacent to the A38 and in close proximity of Junction 28 of the M1 motorway. The boundary between Bolsover, Derbyshire and Ashfield, Nottinghamshire is approximately 150m to the west of the site.</p>	
<p>Local Plan Designation</p>	<p>The Ashfield Local Plan Review (November 2002) and the policies saved by the Secretary of State direction in 2007 comprise the development plan for Ashfield. The entire site is located within the main urban area (Policy ST2). The western half of the site is allocated for employment uses (Policy EM1).</p> <p>The land along Nunn Brook in the north of the site and land to the west of the site is allocated as a Nature Conservation sites (Policy EV6). Land to the west of the site is also identified as Countryside (Policy EV2).</p>	
<p>Status in SHLAA</p>	<p>The vacant development plot in the north of the site is identified in the 2015 Strategic Employment Land Availability Assessment (SELAA) (site ref. S3) as being immediately available.</p>	
<p>Planning History</p>	<p>There are a number of previous planning applications associated with the employment uses onsite.</p> <p>In relation to the vacant development plot to the north of the site, the most recent permissions are:</p>	

	<ul style="list-style-type: none"> • V/2002/0466 Variation of Condition to Renew Time Limit on Outline Application for Industrial Development, granted in June 2002. • V/2008/0583 Reserved Matters for light industrial (E uses) and distribution (B8 uses) granted in November 2008. 	
Current Use and Land Type	This site is an established industrial estate within the wider Huthwaite Industrial area.	
Occupier Profile (if partly developed, including % of available land and levels of vacancy onsite)	<p>The site is occupied by a range of employment uses primarily in the manufacturing and logistics sectors including:</p> <ul style="list-style-type: none"> • Kommerling Profine UK (windows manufacturer) • Consort Windows (window manufacturer) • Solar Calibre Norvik (door manufacturer) • Door-Stop International (door manufacturer) • White Meadow Furniture (furniture manufacturer) • Taylors Transport (logistics) • Dawson Group Temperature Control Solutions (supplier of temperature-controlled vehicles) • Transpakship International (storage and removals) • Mertrux Mercedes Benz (car dealer) <p>The site is fully developed and occupied apart from a 5.7 ha area of vacant land in the north of the site off Export Drive and south of Nunn Brook. It is allocated for Employment Uses in the Local Plan and is on the market as a Design & Build opportunity.</p>	
Strategic Road Access	The site is adjacent to the A38 which is accessed via Common Road. The A38 provides access to Junction 28 of the M1 motorway which is approximately 2km away.	Average
Local Road Access	The site can be accessed from Common Road (B6027) which is a good free-moving road heading south to the A38; it is more constrained heading north to Huthwaite as it passes through residential areas and past a school. The majority of industrial units are located off Export Drive which is a cul-de-sac, with some units accessed directly from Common Road.	Good
Proximity to Urban Areas and Access to Labour and Services (including public transport / cycling / walking accessibility)	The site is located within Huthwaite and is approximately 4km west of Sutton-in-Ashfield. Huthwaite is a village and provides a more limited range of services including small convenience stores, primary schools, a medical centre and local shops. Sutton in Ashfield provides a wider range of facilities and services. Sutton Parkway railway station is approximately 4.8km from the site via	Good

	the A38. There are bus stops on Common Road adjacent to the site with regular services to Mansfield, Mansfield Woodhouse, Alfreton and South Normanton. The Blackwell Trail footpath is approximately 100m north of the site.	
Compatibility of Adjoining Uses (including amenity impacts experienced by current/future occupiers and neighbouring areas)	The site is bound to the north by Nunn Brook and employment uses beyond, to the east by Common Road and employment uses beyond, to the south by the A38 and employment uses beyond, to the west by greenfield land in agricultural use.	Very Good
Developmental and Environmental Constraints (e.g. size; topography; site access; roads, lighting, landscaping, mains utilities and communications infrastructure; flood risk; contamination; nature and heritage conservation)	This is a large gently sloping site within an established industrial area with existing utilities and communications infrastructure. The site is within Flood Zone 1 and therefore at low risk from flooding, except for a narrow strip along Nunn Brook to the north which is within Flood Zone 3 and therefore at a high risk of flooding. There are no heritage assets within or adjacent to the site and no landscape designations. Overhead lines intersect the western half of the site from north to south. There are a number of Local Wildlife Sites to the north and west of the site: <ul style="list-style-type: none"> • Hucknall Disused Railways • New Hucknall Sidings Grasslands • Hucknall Disused Railway 	Good
Barriers to Delivery and Mitigation (including ownership constraints - if known)	The site is fully developed apart from a 5.7 ha area of vacant land in the north of the site off Export Drive and south of Nunn Brook. It is allocated for Employment Uses in the Local Plan and is on the market as a Design & Build opportunity.	Very Good
Market Attractiveness (including appropriateness, vacancy and market activity on site for the type of development proposed)	The site is in an established industrial area in close proximity to the labour market and services of both Huthwaite and Sutton in Ashfield and with good access to the A38 and Junction 28 of the M1 Motorway. It is a popular industrial estate with a low level of vacancies. There is one vacant plot remaining on the site. It comprises of 5.7ha area of land in the north of the site off Export Drive and south of Nunn Brook. It is allocated for Employment Uses in the Local Plan and is on the market as a Design & Build opportunity for up to 19,324 sqm of employment space. The site slopes gently down to Nunn Brook and overhead lines intersect it from north to south.	Good
Strategic Fit with Growth Area Objectives (by target Market Segment)	This site already accommodates key industrial growth sectors as identified in the D2N2 Vision 2030 document and has the potential to	Good

	<p>accommodate additional businesses within these sectors. Key sectors already accommodated on the site include:</p> <ul style="list-style-type: none"> • Construction • Logistics & E-Commerce • Transport Equipment Manufacturing 	
OVERALL SITE RATING	Good	
Recommendation and Potential Future Uses	Allocate for employment uses – allocate undeveloped land, with the remainder of the site protected for employment uses including the whole Common Road/Export Drive industrial estate.	
SITE SUMMARY:		
<p>This is a large industrial estate in the established and popular Huthwaite Industrial area, within close proximity of Junction 28 of the M1 motorway via Common Road and the A38. The site is occupied by a range of employment uses primarily in the manufacturing and logistics sectors. There is one vacant plot remaining on the site, comprising of 5.7ha off Export Drive and south of Nunn Brook. It is allocated for Employment Uses in the Local Plan and is on the market as a Design & Build opportunity for up to 19,324 sqm of employment space. It is considered that the undeveloped land should be allocated for employment uses, with the remainder of the site protected for employment uses including the whole Common Road/Export Drive industrial estate to protect the uses currently onsite and this important local employment area.</p>		

Fulwood Industrial Estate, Fulwood Road (Ref: ADC11)



**GROSS SITE AREA:
31.56 ha**

**ESTIMATED NET DEVELOPABLE AREA:
1.52 ha**

(Note: comprising of the undeveloped Fulwood Road North/Fulwood Industrial Estate EM1sf site (1.6 ha gross) which is allocated in the Ashfield Local Plan Review, 95% gross to net adjustment applied)

CRITERIA	COMMENT	RATING
<p>Site Context</p> <ul style="list-style-type: none"> • Location with regards to existing employment areas and other sites • How the site fits into the overall portfolio 	<p>This site is a large industrial estate in the established and popular Huthwaite Industrial area, it is adjacent to the A38 and within close proximity of Junction 28 of the M1 motorway.</p>	
<p>Local Plan Designation</p>	<p>The Ashfield Local Plan Review (November 2002) and the policies saved by the Secretary of State direction in 2007 comprise the development plan for Ashfield.</p> <p>The entire site is located within the main urban area (Policy ST2). Small sections of the site fronting the A38 and Common Road are allocated for employment uses (Policy EM1). Rookery Park to the east of the site is allocated as Open Area (Policy RC2).</p> <p>There is also an undeveloped area within the north of the site which is allocated in the Ashfield Local Plan Review as Fulwood Road North/Fulwood Industrial Estate EM1sf.</p>	
<p>Status in SHLAA</p>	<p>The Snows Timber site in the north of the site is identified in the 2015 Strategic Employment Land Availability Assessment (SELAA) (site ref. S4) as suitable for employment uses.</p>	
<p>Planning History</p>	<p>There are a number of previous planning applications associated with the employment uses onsite.</p> <p>Recent applications include:</p> <ul style="list-style-type: none"> • V/2016/0767 – Full application for industrial unit – 	

	<p>Granted – 01.02.2017. This has been implemented.</p> <ul style="list-style-type: none"> • V/2020/0557 – Revised Application to Approved Scheme V/2020/0192 to Include Removal of Existing Building and Installation and Operation of a Back-up Electricity Generation and Storage Facility and Ancillary Equipment – Granted – 19.10.2020
Current Use and Land Type	<p>This site is an established industrial estate within the wider Huthwaite Industrial area.</p>
<p>Occupier Profile (if partly developed, including % of available land and levels of vacancy onsite)</p>	<p>The site is occupied by a range of employment uses primarily in the manufacturing and logistics sectors including:</p> <ul style="list-style-type: none"> • Townscape Products (street furniture manufacturers) • Beardsleys Logistics • Alloga UK AP-4 Healthcare Logistics • Maun Motors Commercial Vehicle Sales • Richford Motor Services • Neat Vehicles Manufacturer • DAF Motus Commercials • Keltruck Limited Scania Distributer • Burrows Recovery • Ford + Barley Exhibitions • Mitchell Powersystems (Diesel engine manufacturer) • ECS Engineering • Sulzer Mechanical Engineering • BM Catalysts • Mark Webster Designs Upholstery • Ikon Rotational (furniture supplier) • Celebrity Rotational Furniture • Teamworks Karting <p>There is also a Shell petrol filling station on the site's southern boundary adjacent to the A38.</p> <p>Vacancy levels are low – only two units adjacent to Townscape Products were being advertised to let at the time of the site visit. Albeit, Snows Timber, who occupied a unit in the northern portion of the site (between Fulwood Road North and Fulwood Road South) went into administration in 2020. This site could potentially be redeveloped.</p> <p>There is also an undeveloped area within the north of the site which is allocated in the Ashfield Local Plan Review as Fulwood Road North/Fulwood Industrial Estate EM1sf. Part of the site was developed with land adjacent to the north west (V/2016/0767) and an application has now been approved to remove the building and replace it with a back-up electricity</p>

	generation and storage facility and ancillary equipment (V/2020/055). There remains approximately 1.6 ha gross to be developed.	
Strategic Road Access	The site is adjacent to the A38 which is accessed via Common Road. The A38 provides access to Junction 28 of the M1 motorway which is approximately 2km away.	Average
Local Road Access	The site can be accessed from Common Road (B6027) which is a good free-moving road heading south to the A38, it is more constrained heading north to Huthwaite as it passes through residential areas and past a school. The industrial units are located off Fulwood Road South, Fulwood Rise and Fulwood Road North, with some units accessed directly from Common Road.	Good
Proximity to Urban Areas and Access to Labour and Services (including public transport / cycling / walking accessibility)	The site is located within Huthwaite and is approximately 4km west of Sutton in Ashfield. Huthwaite is a village and provides a more limited range of services including small convenience stores, primary schools, a medical centre and local shops. Sutton in Ashfield provides a wider range of facilities and services. Sutton Parkway railway station is approximately 4.8km from the site via the A38. There are bus stops on Common Road adjacent to the site with regular services to Mansfield, Mansfield Woodhouse, Alfreton and South Normanton.	Good
Compatibility of Adjoining Uses (including amenity impacts experienced by current/future occupiers and neighbouring areas)	The site is bound to the north by Rookery Park, to the east by Rookery Lane and Rookery Park beyond, to the south by the A38, and to the west by Common Road and employment uses beyond.	Very Good
Developmental and Environmental Constraints (e.g. size; topography; site access; roads, lighting, landscaping, mains utilities and communications infrastructure; flood risk; contamination; nature and heritage conservation)	This is a large relatively level site within an established industrial area with existing utilities and communications infrastructure. The site is within Flood Zone 1 and therefore at low risk from flooding. There are no heritage assets within or adjacent to the site. There is a small Local Wildlife Site (Rookery Lane Grassland, Fulwood) in the north of the site off Rookery Lane. The former New Hucknall Colliery site has been developed as a country park, Rookery Park, to the north west of the site.	Good
Barriers to Delivery and Mitigation (including ownership constraints - if known)	There is undeveloped area within the north of the site which is allocated in the Ashfield Local Plan Review as Fulwood Road North/Fulwood Industrial Estate EM1sf, there remains approximately 1.5 ha gross to be developed. No other developmental constraints were apparent from the site visit.	Very Good

<p>Market Attractiveness (including appropriateness, vacancy and market activity on site for the type of development proposed)</p>	<p>The site is in an established industrial area in close proximity to the labour market and services of both Huthwaite and Sutton in Ashfield and with good access to the A38 and Junction 28 of the M1 Motorway. It is a popular industrial estate with a low level of vacancies.</p> <p>Two units adjacent to Townscape Products off Fulwood Road South were being advertised to let from March 2021 (. They comprise of 477 sqm B2/B8 space and 90 sqm office space set within the 0.28ha site with additional storage land potentially available.</p>	<p>Good</p>
<p>Strategic Fit with Growth Area Objectives (by target Market Segment)</p>	<p>This site already accommodates key industrial growth sectors as identified in the D2N2 Vision 2030 document and has the potential to accommodate additional businesses within these sectors. Key sectors already accommodated on the site include:</p> <ul style="list-style-type: none"> • Logistics & E-Commerce • Transport Equipment Manufacturing • Healthcare • Construction 	<p>Good</p>
<p>OVERALL SITE RATING</p>	<p>Good</p>	
<p>Recommendation and Potential Future Uses</p>	<p>Allocate for employment uses – allocate undeveloped land and protect remainder of site for employment uses – the boundary should include the whole Fulwood Road Industrial Estate.</p> <p>The Fulwood Road North/Fulwood Industrial Estate EM1sf site which is allocated in the Ashfield Local Plan Review should be retained for employment.</p>	
<p>SITE SUMMARY:</p>		
<p>This is a large industrial estate in the established and popular Huthwaite Industrial area, within close proximity of Junction 28 of the M1 motorway via Common Road and the A38. The site is occupied by a range of employment uses primarily in the transport manufacturing and logistics sectors. It is considered that the undeveloped land should be allocated for employment uses and the remainder of site protected for employment uses. The whole estate should be protected for employment uses to help retain the uses currently onsite and this important local employment area. The Fulwood Road North/Fulwood Industrial Estate EM1sf site allocated in the Ashfield Local Plan Review should be retained for employment.</p>		

**Extension/new site in the vicinity of Sherwood Business Park, Junction 27 M1
Motorway
(Ref: ADC12/13)**



**GROSS SITE AREA:
57.45 ha**

**ESTIMATED NET DEVELOPABLE AREA:
18.42 ha**

(Note: Based on the site area in the SHELAA assessment for the northern site only (20.47ha) as the southern site is substantially impacted by HS2. It is based on a ratio of 90% gross to net given it would be a major extension to the Sherwood Business park and would require roads and landscaping.)

CRITERIA	COMMENT	RATING
<p>Site Context</p> <ul style="list-style-type: none"> • Location with regards to existing employment areas and other sites • How the site fits into the overall portfolio 	<p>This site is adjacent to Junction 27 of the M1 Motorway and established Sherwood Business Park. The site is split into two portions – the land north of Mansfield Road ‘northern site’ and land south of Mansfield Road ‘southern site’. The northern site is adjacent to the HS2 safeguarded route and the southern site is substantially impacted by HS2 Safeguarding Land, both in terms of the route and also for a major compound and temporary material stockpile. This site should be seen in the context of other sites coming forward in the vicinity including the proposed Garden Village at Top Wighay Farm, Gedling which is approximately 4km to the south east on Annesley Road / A611 roundabout. An outline application (ref. 2020/0050) was submitted in January 2020 for 805 homes, up to 49,500 sqm of B1/B8 uses, a Local Centre, a 1.5 form entry Primary School and associated infrastructure, open space and landscaping. If this site is brought forward then this will meet some local demand for employment space.</p>	

	This site has been identified as a possible growth area and extension to the existing Sherwood Business Park.	
Local Plan Designation	The sites are identified as being within the Green Belt in the Ashfield Local Plan Review (Adopted November 2002).	
Status in SHLAA	Both sites were submitted to the SHLAA for employment development.	
Planning History	There is no relevant planning history in relation to either site.	
Current Use and Land Type	They are both greenfield sites in agricultural use and located within the Green Belt.	
Occupier Profile (if partly developed, including % of available land and levels of vacancy onsite)	Not applicable as they are greenfield sites.	
Strategic Road Access	This site is adjacent to Junction 27 of the M1 Motorway, which can be accessed via Mansfield Road (A608). The A611 is approximately 1.7km from the site via the A608.	Very Good
Local Road Access	<p>There are existing farm track accesses to both sites from Mansfield Road which is a good, free-moving road and connects to the M1 immediately to the west and to Derby Road (A611) to the east and Mansfield beyond.</p> <p>However, previous site assessments identified that the access from Mansfield Road to the northern site is not suitable to accommodate the development of this site and therefore this site must be accessed from the existing Sherwood Park road network. It may be possible to achieve direct access from Willow Drive and the western spur road from the roundabout (providing access to SPS Aerostructures Limited) albeit there is some change in levels.</p> <p>A masterplan access strategy would need to be submitted to the Highways Authority for the southern site as it would significantly impact upon the A608/M1 strategic road network/movement corridor.</p> <p>The southern site also has farm track access from Weavers Lane to the east/south. To the south of the southern site, Weavers Lane crosses the M1 via a bridge.</p>	Poor
Proximity to Urban Areas and Access to Labour and Services	The nearest urban areas are Annesley and Annesley Woodhouse approximately 1.5km to the	Average

(including public transport / cycling / walking accessibility)	<p>north. There are bus stops located on Willow Drive approximately 150m north of the site with regular services to Mansfield, Nottingham and Derby. There is a cycle route from Sherwood Business Park through Annesley and north to Kirkby and Sutton.</p> <p>Public Footpaths 8 and 9 intersect the northern site and Footpath 7 abuts the south eastern boundary. Bridleway 1 runs along Weavers Lane on the south-eastern boundary of the southern site.</p>	
<p>Compatibility of Adjoining Uses (including amenity impacts experienced by current/future occupiers and neighbouring areas)</p>	<p>The northern site is bound by greenfield land in agricultural use and Sherwood Business Park to the north. SPS Aerostructures Limited occupy the adjacent unit and the other unit is currently vacant. It is currently being advertised to let and is described as Evolution 27, also known as Chadwick House, it comprises of 20,198.60 sqm of HQ office and warehousing/industrial space. The site is bound to the east by Willow Drive (providing access to Sherwood Business Park), Mansfield Road to the south and the M1 to the west.</p> <p>The southern site is bound by Mansfield Road to the north, Weavers Lane and agricultural buildings associated with Home Farm as well as an Equestrian Centre to the east, Weavers Lane to the south and agricultural land beyond, and the M1 to the west.</p> <p>Both sites are adjacent to the M1 which may be a constraint to development. Furthermore, the northern site is adjacent to the HS2 safeguarded route and the southern site is substantially impacted by HS2 Safeguarding Land, both in terms of the route and also for a major compound and temporary material stockpile.</p> <p>A Scheduled Ancient Monument (Fishponds 170m south of Damstead Farm – List Entry Number - 1018119) is located approximately 140m to the north of the northern site.</p> <p>Annesley Hall Registered Park and Gardens (Grade II* - List Entry Number: 1001077) which includes a number of listed buildings and scheduled monuments is adjacent to the southern site on the eastern side of Weavers Lane.</p>	Average
<p>Developmental and Environmental Constraints (e.g. size; topography; site access;</p>	<p>Both sites are located within the Green Belt, contain some mature trees and hedgerows and are gently undulating. Both sites are within an</p>	Poor

<p>roads, lighting, landscaping, mains utilities and communications infrastructure; flood risk; contamination; nature and heritage conservation)</p>	<p>SSSI Impact Risk Zone.</p> <p>There is a fault line along the western boundary and across the centre of the sites which is likely to result in ground stability issues. The sites are in a coal low risk area.</p> <p>The sites are within Flood Zone 1 and therefore at a low risk of flooding from watercourses. Small areas of low risk from surface water flooding are throughout both sites.</p> <p>Access is a constraint for both sites.</p> <p><u>Northern Site</u></p> <p>Land to the west of the site adjacent to the M1 forms part of the HS2 safeguarded route. A high-pressure gas pipeline also runs adjacent to the northern boundary of the northern site. There is a corridor of coal 'high risk' immediately adjacent to the northern boundary of the northern site.</p> <p>The site slopes down to the north and there is an approximate difference in levels of 2-3m between the site and Willow Drive - the access road to Sherwood Business Park.</p> <p>There are telephone masts located in the north eastern corner and overhead lines intersect the south eastern corner and run parallel to the southern boundary.</p> <p>The site is within the Kirkby Quarry, Portland Park and Rise Hill landscape character area, the condition varies from poor to moderate, the landscape character is poor and the landscape strategy is create.</p> <p>Davis's Bottom Pasture Local Wildlife Site is adjacent to the northern boundary of the site and Davis's Bottom Grassland Local Wildlife Site is adjacent to the eastern site boundary. Land to the north of the site is identified as 'good quality semi-improved grassland' and 'broadleaved deciduous woodland' to the east and west. Land to the north of the site is within a buffer zone.</p> <p>A Scheduled Ancient Monument (Fishponds 170m south of Damstead Farm – List Entry Number - 1018119) is located approximately 140m to the north of the site.</p> <p>Public Footpaths 8 and 9 intersect the site and Footpath 7 abuts the south eastern boundary. Previous site assessments identified that the</p>	
--	---	--

access from Mansfield Road to the northern site is not suitable to accommodate the development of this site and therefore this site must be accessed from the existing Sherwood Park road network. It may be possible to achieve access from Willow Drive and the western spur road from the roundabout (providing access to SPS Aerostructures Limited) albeit there is some change in levels.

Southern Site

The site is substantially impacted by HS2 Safeguarding Land, both in terms of the route and also for a major compound and temporary material stockpile.

There is a telephone mast and service box located at the northern boundary of the site and overhead lines run along the eastern and southern boundaries. There are also two established woodlands within the site 'Aubrey Wood' located in the south-western corner of the site and William Wood Spinney on the western side of the site. Bridleway 1 runs along Weavers Lane on the south-eastern boundary.

Annesley Hall Registered Park and Gardens (Grade II* - List Entry Number: 1001077) is adjacent to the southern site on the eastern side of Weavers Lane. There are various listed buildings and scheduled monuments within this area including:

- Annesley Hall (Grade II Listed – List Entry Number: 1234836) approximately 400m to the east of the site;
- Terrace to the south west of Annesley Hall (Grade II Listed - List Entry Number: 1234839);
- Gatehouse Range at Annesley Hall (Grade II Listed – List Entry Number: 1234843);
- Annesley Lodge (Grade II Listed – List Entry Number: 1234846);
- Scheduled Monument All Saints Church and graveyard, 150m south of Annesley Hall Lodge (List Entry Number: 1020778); and
- Scheduled monument Annesley motte and bailey castle (List Entry Number: 1009305) is located approximately 1km east of the site.

The northern area of the Registered Park and Garden has since been incorporated within the Sherwood Business Park.

The site is within the Moorgreen Rolling

	<p>Woodland landscape area which is of a moderate condition and strong character, the landscape strategy for this area is conserve and enhance.</p> <p>There are two Local Wildlife Sites adjacent to the south east boundary (Oak Plantation – Annesley and Weavers Lane Grassland). Part of the site is also identified as a priority habitat – deciduous woodland, broadleaved and conifer forests.</p> <p>There is a strip of land at high risk of flooding within the centre of the southern site. A masterplan access strategy would need to be submitted to the Highways Authority for the southern site as it would significantly impact upon the A608/M1 strategic road network/movement corridor. The southern site also has farm track access from Weavers Lane to the east/south. To the south of the southern site, Weavers Lane crosses the M1 via a bridge.</p>	
<p>Barriers to Delivery and Mitigation (including ownership constraints - if known)</p>	<p>The northern site has a single landowner and is available for employment development. There are no ownership constraints for the southern site.</p> <p>However, there are a number of barriers to delivery and areas where mitigation would be required as follows:</p> <ul style="list-style-type: none"> • The site is within the Green Belt and therefore it is necessary to demonstrate that there are exceptional circumstances for the site to be taken out of the Green Belt. • The significant access constraints would need to be overcome in order to develop the site. The northern site would need to be accessed from Sherwood Business Park and access to the southern site would significantly impact upon the A608/M1 strategic road network/movement corridor. • Likely ground stability issues due to the presence of a fault line. • As well as the mature trees and hedgerows on the site, there are also Local Wildlife Sites adjacent so any potential development would need to assess and mitigate impacts upon biodiversity. • Potential harm to the significance of Damstead Farm Fishponds and Annesley Hall Registered Park and Garden would need to be assessed. 	<p>Poor</p>

	<ul style="list-style-type: none"> The northern site is adjacent to the M1 and also within the HS2 safeguarded route. The southern site is adjacent to the M1 and substantially impacted by the HS2 safeguarded route and land identified for a compound. Identified areas of low to high risk from surface water flooding will need mitigating. <p>If this site is to come forward, then there will need to be very careful landscaping/planting to the south and east in order to secure the boundaries.</p>	
Market Attractiveness (including appropriateness, vacancy and market activity on site for the type of development proposed)	These sites are in an attractive location adjacent to Junction 27 of the M1 and an established business park. Indeed, the SHLAA Assessment identified developer interest in the northern site. However, there are significant barriers to delivery as well as mitigation required as discussed above.	Good / Average
Strategic Fit with Growth Area Objectives (by target Market Segment)	In view of the accessible location of the site from the M1 and nearby urban areas, this site is well-placed to accommodate key industrial sectors targeted by D2N2 and contribute to growth objectives, particularly transport, manufacturing and logistics.	Good
OVERALL SITE RATING	Average	
Recommendation and Potential Future Uses	<p>Allocate the northern site for employment uses, do not allocate the southern site.</p> <p>It is considered that the northern site is suitable for the provision of employment uses as an extension of the adjacent Sherwood Business Park, subject to demonstration of exceptional circumstances for removal from the Green Belt and overcoming the access issues and other constraints.</p> <p>As the majority of the southern site is substantially impacted by HS2 Safeguarding Land, both in terms of the route and also for a major compound and temporary material stockpile, this would result in a limited developable area. Therefore, it is not suitable for allocation for alternative uses at the current time. However, should the situation with HS2 change and the land is no longer safeguarded then this site could be developed for employment uses subject to addressing the identified constraints.</p>	
SITE SUMMARY:		
This site is adjacent to Junction 27 of the M1 Motorway and established Sherwood Business Park. The site is split into two portions – the land north of Mansfield Road ‘northern site’ and land south of Mansfield Road ‘southern site’. The northern site is adjacent to the HS2 safeguarded route and the southern site is substantially impacted by HS2 Safeguarding Land.		

This site has been identified as a possible growth area and extension to the existing Sherwood Business Park and both sites have been put forward by the landowners for employment development.

The sites are identified as Green Belt and therefore, it would be necessary to demonstrate that there are exceptional circumstances for removal from the Green Belt. There are a number of constraints representing barriers to delivery and areas where mitigation would be required as follows: significant access constraints with the northern site requiring access from Sherwood Business Park and access to the southern site significantly impacting the strategic road network; the impact of the adjacent M1 and the HS2 safeguarded route; potential harm to the significance of nearby heritage assets and local wildlife sites; likely ground stability issues due to a fault line and some surface water flooding risk.

It is considered that northern site should be allocated for employment uses but the southern site should not be allocated. Subject to overcoming the constraints identified, the northern site is suitable for the provision of employment uses as an extension of Sherwood Business Park. As the majority of the southern site is substantially impacted by HS2 Safeguarding Land, it is not considered suitable for allocation for alternative uses. However, should the situation with HS2 change and the land is no longer safeguarded then this site could be developed for employment uses subject to addressing the identified constraints.

**Part of the Potential New Settlement Site between Pinxton Lane & Kirkby Road (B6019), Kirkby-in-Ashfield (by Junction 28 of the M1)
(Ref: ADC14)**



**GROSS SITE AREA:
16.98 ha**

**ESTIMATED NET DEVELOPABLE
AREA:
13.58 ha**

(Note: Based on an 80% ratio to account for the provision of roads and landscaping as well as the brook and overhead lines intersecting the site.)

CRITERIA

COMMENT

RATING

Site Context

- Location with regards to existing employment areas and other sites
- How the site fits into the overall portfolio

The site is located south of the Castlewood Business Park and the A38, with the Huthwaite Industrial Areas off Common Road and the East Midlands Designer Outlet beyond this. The site is in close proximity to Junction 28 of the M1 Motorway – c. 2.8km as well as being within c. 3km of the main urban areas of Kirkby-in-Ashfield and Sutton in Ashfield. Part of the western boundary of the site adjoins the boundary for Bolsover District.

This site is within the boundary of a wider area currently being considered for a potential new settlement between Pinxton Lane & Kirkby Road (B6019), Kirkby-in-Ashfield. This study is ongoing. It is anticipated that the entire site would be developed for housing, however, alternative uses for the northern part of the site (the appraisal site) are being considered and given the location adjacent to the Castlewood Business Park, employment uses are a possible option.

Local Plan Designation

The site is identified as countryside in the Ashfield Local Plan Review (Adopted November 2002). The site is identified as being within the countryside but is not within the Green Belt.

The Maghole Brook on the southern boundary is a Local Wildlife Site and an Ancient Woodland is identified to the southeast edge of the site along the Maghole Brook. The site

	is also within an SSSI Impact Risk Zone.	
Status in SHLAA	This site was not submitted to the SHELAA; however, sites surrounding this site to the east, south and west were submitted to the SHELAA.	
Planning History	<p>At the time of the site visit, new residential properties were under construction adjacent to the Crow Tree farmhouse on the northern boundary of the site (Planning application ref: V/2013/0110). Furthermore, Crow Tree Solar Farm to the east of the site, was granted permission in 2014 (ref. V/2014/0188) and is due to expire on the 31st June 2039. This limits development for employment purposes to the west.</p> <p>Other than a hedgerow removal, there is no planning history on the appraisal site.</p>	
Current Use and Land Type	This is a greenfield site in agricultural use.	
Occupier Profile (if partly developed, including % of available land and levels of vacancy onsite)	Not applicable as this is a greenfield site.	
Strategic Road Access	The site is approximately 600m from the A38 via Pinxton Lane and 2.8km from Junction 28 of the M1 Motorway via Pinxton Lane and the A38. Pinxton lane is quite narrow and unsuitable for vehicles in excess of 7.5 tonnes except for access.	Poor / Average
Local Road Access	The site can be accessed from the A38 via Pinxton Lane to the North and via Brookhill Lane then Pinxton Lane to the south. However, Pinxton Lane itself is quite narrow and unsuitable for vehicles in excess of 7.5 tonnes except for access. There are two farm access gates off Pinxton Lane to the south-western side of the site. Should the site be developed for employment uses it is likely that work would be needed to Pinxton Lane to make it suitable for HGVs.	Poor
Proximity to Urban Areas and Access to Labour and Services (including public transport / cycling / walking accessibility)	<p>The site is within 3km of the main urban areas of Kirkby-in-Ashfield and Sutton in Ashfield. The nearest bus stop is the Grange Farm stop on Pinxton Lane, 500m north of the site. Hourly services travel between Sutton, Kirkby, Selston and Ripley from here. There are also bus stops 650m north of the site on the A38 Alfreton Road with half-hourly services to Mansfield and Derby.</p> <p>The site is accessible by cycle from Sutton in</p>	Average

	Ashfield via a bridleway which ends at Crow Tree Farm. This route intersects Castlewood Business Park and runs along the A38 before branching off to Sutton in Ashfield.	
Compatibility of Adjoining Uses (including amenity impacts experienced by current/future occupiers and neighbouring areas)	The site is bound by Pinxton Lane and Crow Tree Farm to the north, Crow Tree Solar Farm to the east, a belt of mature trees and Maghole Brook to the south, and greenfield land in agricultural use to the west. There may be issues concerning the site's compatibility with the solar panels on the solar farm to the east.	Average
Developmental and Environmental Constraints (e.g. size; topography; site access; roads, lighting, landscaping, mains utilities and communications infrastructure; flood risk; contamination; nature and heritage conservation)	<p>The site slopes gently from north to south, down towards the belt of mature trees and Maghole Brook. A public bridleway and footpath intersect the site from North to South. Overhead lines and wooden pylons also cross the site from the western boundary to Maghole Brook, then south to the site boundary. Furthermore, a line of mature trees and the brook intersect a portion of the site from the southern boundary.</p> <p>Ashfield District Council's constraints map identified two historic landfills on the site and that part of the site is formed by a former railway line.</p> <p>The Maghole Brook and the former railway line on the southern boundary of the site are identified Local Wildlife Sites and the trees to the southeast edge of the site along the Maghole Brook are an identified Ancient & Semi-Natural Woodland - The Dumbles. These trees are also subject to a Tree Preservation Order (TPO ref no. 068).</p> <p>Ashfield's Biodiversity Opportunities Maps identify that there are opportunities in relation to trees and mires along the route of the Maghole Brook.</p> <p>Furthermore, the HS2 Safeguarded Route runs c. 300m to the west of the site. A high-pressure gas main also runs to the west of the site.</p> <p>Flood risk in this location is low, the site is identified as being in Flood Zone 1.</p>	Poor
Barriers to Delivery and Mitigation (including ownership constraints - if known)	The site is part of a wider site being considered for a potential new settlement and a number of landowners to the south have put land forward for development in the SHELAA. However, the appraisal site is in multiple ownerships and the landowners have been approached by the Council	Poor

	<p>but the sites have not been put forward for development.</p> <p>There is a solar farm to the north east of the site, which would presumably have a life of 25 years. (Planning permission was granted in 2014, V/2014/0188). This may limit development for employment purposes on the Pinxton lane site, which is situated immediately to the west. This would need to be explored further with the site operator.</p>	
<p>Market Attractiveness (including appropriateness, vacancy and market activity on site for the type of development proposed)</p>	<p>The site is adjacent to the Castlewood Business Park and in close proximity to Junction 28 of the M1. Castlewood Business Park is home to a number of high-profile businesses including a major new food distribution depot for The Co-op, Parker Knoll Furniture Manufacturing, Bombardier Plane and Train Manufacturer, Midland Aerospace and Alloga Healthcare Logistics. There are a number of B2/B8 units currently available on the Castlewood Business Park as follows: Plot 1 - 19,510 sqm Plot 8 - 7,432 sqm Plot 10 – 9,290 sqm Plot 5 – 1,394 sqm Plot 11B – 2,970 sqm Plot 11C – 1,100 sqm Albeit, the HS2b safeguarded route runs through the business park and will impact some of the plots, namely plot 10. This could limit the net developable area significantly.</p>	<p>Good / Average</p>
<p>Strategic Fit with Growth Area Objectives (by target Market Segment)</p>	<p>In view of the accessible location of the site from the M1 and nearby urban areas, this site is well-placed to accommodate key industrial sectors targeted by D2N2 and contribute to growth objectives, particularly transport manufacturing, transport and logistics and low carbon.</p>	<p>Good</p>
<p>OVERALL SITE RATING</p>	<p>Average</p>	
<p>Recommendation and Potential Future Uses</p>	<p>Allocate for employment uses.</p> <p>It is considered that this site is suitable for expansion of the adjacent business park. This site could come forward as part of the proposed wider new settlement. Should the site not come forward for employment uses, then a potential alternative use could be the provision of renewable energy infrastructure.</p>	
<p>SITE SUMMARY:</p>		
<p>The site is located south of the Castlewood Business Park and the A38 and in close proximity to Junction 28 of the M1 Motorway. The site is approximately 600m from the A38 via Pinxton</p>		

Lane however, Pinxton lane is quite narrow and unsuitable for vehicles in excess of 7.5 tonnes except for access. The site is accessible to the main urban areas of Kirkby-in-Ashfield and Sutton in Ashfield via cycle or regular bus services. This site is within the boundary of a wider area currently being considered for a potential new settlement between Pinxton Lane & Kirkby Road (B6019), Kirkby-in-Ashfield.

This is a greenfield site in agricultural use, it is located within the countryside but is not within the Green Belt. There are a number of constraints to development of the site including the access restrictions on Pinxton Lane, proximity to the solar farm immediately to the north east which may prohibit the development of large buildings to the south west for the duration of the solar parks' permission; the overhead lines and three public footpaths intersecting the site as well as identified Local Wildlife Sites and Ancient and Semi-Natural Woodland on the site's southern boundary. Furthermore, there are two historic landfills on the site and part of the site is formed by a former railway line. In terms of delivery, the site is in multiple ownerships and the landowners have been approached by the Council but the sites have not been put forward for development. This could represent a barrier to delivery if the landowners are not willing and able.

However, if these constraints can be overcome, then in view of the accessible location of the site from the M1 and nearby urban areas, this site is well-placed to accommodate key industrial sectors targeted by D2N2 and contribute to growth objectives, particularly transport manufacturing, transport and logistics and low carbon. It is considered that this site should be allocated for employment uses, it is suitable for expansion of the adjacent business park. This site could come forward as part of the proposed wider new settlement. Should the site not come forward for employment uses, then a potential alternative use could be the provision of renewable energy infrastructure.

**Rushley Farm off the A60, Sutton in Ashfield
(Ref: ADC15)**

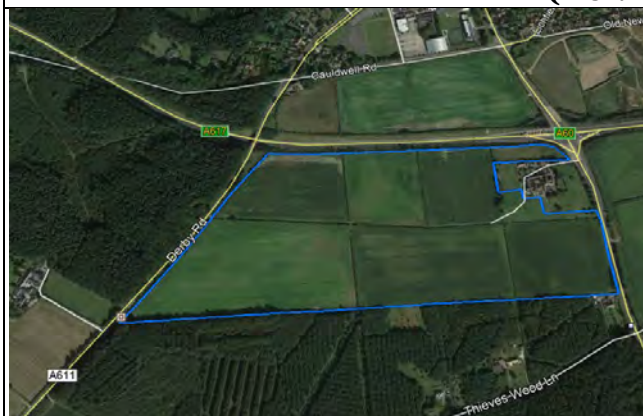

**GROSS SITE AREA:
31.01 ha**

**ESTIMATED NET DEVELOPABLE
AREA:
23.26 ha**

(Note: Based on a 75% ratio 'land allocated for business park with high landscape quality', this is to take into account the need for spur roads, some bunding due to the topography and landscaping)

CRITERIA	COMMENT	RATING
<p>Site Context</p> <ul style="list-style-type: none"> • Location with regards to existing employment areas and other sites • How the site fits into the overall portfolio 	<p>The site is located within the north-eastern corner of Ashfield District adjacent to the boundary with Mansfield. It is within the open countryside and is separated from the main urban area of Mansfield by the Mansfield and Ashfield Regeneration Route [MARR]. The new Amazon Distribution Centre at Summit Park off Sherwood Way South is approximately 1.5km to the west of the site.</p> <p>Land to the west of Derby Road has been identified for a possible new settlement. This land is also to the west of the appraisal site.</p>	
<p>Local Plan Designation</p>	<p>The site is identified as countryside in the Ashfield Local Plan Review (Adopted November 2002). The site is not within the Green Belt, the boundary of which is to the south of the site.</p>	
<p>Status in SHLAA</p>	<p>The site comprises of two areas submitted to the SHLAA: sites SA027 and SA060. Site Reference SA027 identifies that a substantial part of the site is currently put forward by the landowner for housing. We understand that discussions have been held with the landowner to test whether the site could be identified for employment as well as housing. Site SA060 is a small area around Rushley Farm that has also been put forward by the landowner for housing.</p>	
<p>Planning History</p>	<p>The only recent planning applications on the appraisal site are associated with the buildings at Rushley Farm.</p>	

	<p>To the north of the site on the other side of the A617, land south of Cauldwell Road was submitted for housing to the SHELAA and proposed to be allocated for housing in the Local Plan which was withdrawn in 2018. However, an Environmental Impact Assessment Screening Opinion request was submitted in June 2020 (ref. 2020/0265/SCRE) for a hybrid application for infrastructure development to include highways and drainage (full planning application) and residential development for up to 200 dwellings (outline planning application) on land north of the A617 and south of Cauldwell Road.</p> <p>To the north and east of the site, there is the Lindhurst, strategic mixed-use development site. Outline planning permission was granted (ref. 2010/0089/ST) in 2013 for development of 169.3 hectares for employment, commercial, residential, retail, healthcare, community, educational and leisure uses including the provision of a new primary school, local centre, community park, landscaping, habitat creation and infrastructure including roads, drainage and services. This is being delivered by David Wilson and Barratt Homes.</p>	
Current Use and Land Type	This is a greenfield site in agricultural use.	
Occupier Profile (if partly developed, including % of available land and levels of vacancy onsite)	Not applicable as this is a greenfield site.	
Strategic Road Access	The site adjoins the A60 and A617 trunk roads. It is also within 900m of the A611.	Average
Local Road Access	<p>There is no existing vehicular access from the A617 to the north and there are levels differences between the site and the A617 which could make access from the northern boundary challenging.</p> <p>However, there are multiple farm access points to the site. To the north east the site can be accessed via the A60 through the Rushley Farm residential estate; however, this would not be suitable for industrial traffic. The site can also be accessed via a gate and farm track from the A60. There is an additional farm track access to the western boundary of the site from Derby Road.</p> <p>Access to this site would need to be considered comprehensively with the</p>	

	<p>Lindhurst extension and any development coming forward north of the A617 and south of Cauldwell Road. It has been previously identified that existing accesses are in close proximity to and conflict with existing major junctions which could present a major barrier to development if this cannot be overcome.</p>	
<p>Proximity to Urban Areas and Access to Labour and Services (including public transport / cycling / walking accessibility)</p>	<p>The site is to the south of Mansfield and less than 1km from the Berry Hill residential neighbourhood. The site is within approximately 700m of the Vision West Nottinghamshire College.</p> <p>The nearest bus stops are approximately 150m south of the site on the A60 at Thieves Wood Lane with regular services between Mansfield and Nottingham.</p> <p>A cycle route runs along the western boundary of the site and connects with Sutton-in-Ashfield and Kirkby in Ashfield.</p>	<p>Good</p>
<p>Compatibility of Adjoining Uses (including amenity impacts experienced by current/future occupiers and neighbouring areas)</p>	<p>The site is bound by the A617 Sherwood Way South to the north, Rushley Farm (locally listed heritage asset) and residential dwellings to the north eastern corner and the A60 to the east, woodland to the south and the A611 Derby Road to the west.</p>	<p>Average</p>
<p>Developmental and Environmental Constraints (e.g. size; topography; site access; roads, lighting, landscaping, mains utilities and communications infrastructure; flood risk; contamination; nature and heritage conservation)</p>	<p>The site slopes at a gentle gradient from north to south. Overhead lines and wooden pylons intersect the site from north east to south west and also run parallel to Rushley Farm to the south and across to the A60. There is also an electricity metre box in the eastern side of the site. There is a Western Power wayleave on the boundary of the site.</p> <p>There is a public footpath (FP66) through the site from the north which is accessed via a staircase over the A617 highway verge to the rear of Rushley Farm.</p> <p>The majority of the Site is within 400 m of a possible potential Special Protection Area for Sherwood Forest in relation to Nightjars and Wood Larks. However, the issue appears to be cats associated with housing, so employment may be less of an issue. Clarification from Natural England on this matter would be needed.</p>	<p>Average / Poor</p>

	<p>There are mature trees and hedgerows to the site boundaries and the site is located within Landscape Policy Zone “<i>SH11 Lindhurst Wooded Farmlands</i>”. The landscape condition and sensitivity are defined as moderate and the landscape strategy is to conserve and create. In addition, part of Thieves Wood is identified as a priority habitat – Deciduous Woodland.</p> <p>The Natural England Agricultural Land Classification Map East Midlands Region Map (2010) identifies the site to be within an area of very good (Grade 2) to good (Grade 3a) quality agricultural land. Development of this site would result in the loss of this good quality agricultural land.</p> <p>Flood risk in this location is low, as the site is identified as being in Flood Zone 1. There is no identified risk from surface water flooding.</p> <p>There are no known ground stability issues and the site is in a coal low risk area.</p> <p>Rushley Farm is a locally listed heritage asset and therefore any development of this site would need to assess the potential harm to the significance of Rushley Farm.</p>	
<p>Barriers to Delivery and Mitigation (including ownership constraints - if known)</p>	<p>The site comprises of land in two separate ownerships and both landowners have submitted the sites to the SHELAA for housing development. However, SHELAA Site SA027 is subject to a lease/tenancy.</p>	<p>Average</p>
<p>Market Attractiveness (including appropriateness, vacancy and market activity on site for the type of development proposed)</p>	<p>This is a large relatively level site within close proximity of Mansfield and adjacent to the A60 and A617 trunk roads. However, potential access issues will need to be overcome and the nearby Sherwood Forest ppSPA and adjacent Rushley Farm locally listed asset pose constraints to the future development of the site. Should the site constraints be overcome/mitigated then the site could potentially be attractive for development for residential uses, uses associated with the nearby colleges or for a high-quality business park.</p>	<p>Average</p>
<p>Strategic Fit with Growth Area</p>	<p>The site is approximately 3km south of the</p>	<p>Average</p>

<p>Objectives (by target Market Segment)</p>	<p>centre of Mansfield and adjacent to the A60 and A617 trunk roads.</p> <p>The site may not be appropriate for heavy industrial uses without very significant infrastructure investment but could potentially be allocated for a business park and accommodate creative & digital businesses or professional/business services.</p>	
<p>OVERALL SITE RATING</p>	<p>Poor</p>	
<p>Recommendation and Potential Future Uses</p>	<p>Allocate for employment uses.</p> <p>It is considered that should the site not be developed for residential uses, it would most suitable for a high-quality business park or for uses associated with the nearby colleges, although significant challenges need to be overcome regarding highways access and associated infrastructure.</p>	
<p>SITE SUMMARY:</p>		
<p>The site is located within the north-eastern corner of Ashfield District and adjacent to the boundary of Mansfield. It is within the countryside and is separated from the main urban area of Mansfield by the Mansfield and Ashfield Regeneration Route (MARR). The site adjoins the A60 and A617 trunk roads. There is no existing vehicular access from the A617 to the north and there are levels differences between the site and the A617 which could make access from the northern boundary challenging. However, there are multiple farm access points to the site to the east and west. Access to this site would need to be considered comprehensively with the Lindhurst extension and any development coming forward north of the A617 and south of Cauldwell Road, it has been previously identified that existing accesses are in close proximity to and conflict with existing major junctions.</p> <p>The site is not within the Green Belt; however, it is a greenfield site in agricultural use. There are a number of constraints to development of the site including the access restrictions, the overhead lines and public footpath intersecting the site as well as the locally listed Rushley Farm to the north of the site and the nearby possible potential Special Protection Area for Sherwood Forest. In terms of delivery, the site comprises of two landholdings and both landowners have suggested that the area is potentially available for residential development within the next 15 years.</p> <p>It is considered that should the site not be developed for residential uses, it would most suitable for a high-quality business park or for uses associated with the nearby colleges, although significant challenges need to be overcome regarding highways access and associated infrastructure.</p>		

Chilwell Meadows Business Park (Ref: BBC1)



GROSS SITE AREA:
8.83 ha

ESTIMATED NET DEVELOPABLE AREA:
0 ha

CRITERIA	COMMENT	RATING
<p>Site Context</p> <ul style="list-style-type: none"> • Location with regards to existing employment areas and other sites • How the site fits into the overall portfolio 	<p>The site is located at the south-east edge of the village of Toton, to the east of Long Eaton and approximately 9.8km from Nottingham City Centre. The site neighbours Chilwell Retail Park, Eldon Road Business Park and West Point shopping centre with Chetwynd Barracks located to the north of the site.</p> <p>The site is identified within the adopted Local Plan as an Existing Employment site, neighbouring other employment areas in the immediate vicinity.</p>	
<p>Local Plan Designation</p>	<p>The site is allocated as an Existing Employment Sites: Chilwell Meadows Business Park (Policy 9) within the Part 2 Local Plan (adopted October 2019).</p> <p>The site borders the Green Belt (Policy 8) to the south and west, with Attenborough Gravel Pits and Nature Reserve also to the south (Policy 28.1c; 28.1f; 31.2a)</p>	
<p>Status in SHLAA</p>	<p>N/A</p>	
<p>Planning History</p>	<p>Recent planning history includes:</p> <ul style="list-style-type: none"> • 04/01064/FUL – Full planning application – Construct 51-bedroom extension (revised scheme) Village Hotel and Leisure Club – Granted 24.03.05 • 05/00797/FUL– Full planning application – Construct extension to existing gym, utilising area below an existing terrace – Granted 12.09.05 • 05/00395/FUL – Full planning application – Change of use to car rental depot and erect fence to front of site – Granted 21.06.05 • 08/00333/ADV – Advertisement consent application 	

	<ul style="list-style-type: none"> – Display 3 No internally illuminated signs and totem – Granted 16.06.08 • 08/00125/FUL – Change of use from textile manufacturing (Class B2) to warehousing (Class B8) – Granted 04.04.08 • 09/00250/FUL – Full planning application – Erect storage container – Granted 17.04.09 • 10/00740/FUL – Full planning application – Change of use from petrol filling station to retail (Class A1) – Granted 04.02.11 • 10/00739/FUL – Full planning application – Change of use from storage or distribution (Class B8) to general industry (Class B2) & installation of 2 No gas storage tanks – Granted 04.02.11 • 13/00403/FUL – Full planning application – Change of Use from service station shop (Class A1) to customer waiting room and staff room – Granted 23.08.13 • 13/00415/FUL – Full planning application – Construct single storey extension – Granted 05.09.13 • 14/00056/FUL – Full planning application - Retain 2.1m x 1.4m fresh air duct / louvre to the rear elevation and retain extract duct stack through the roof – Granted 21.03.14
Current Use and Land Type	<p>An active business/industrial park with hotel and leisure facilities comprising of class C1, D1, E and F1 (a) premises. The buildings are in a good/very good condition.</p> <p>Business information provided by Broxtowe Borough Council (dated April 2019) notes the total B2/B8 floorspace across the site is 15,650.03 sqm with 236 employees working within the Business Park.</p> <p>The total rateable value of the businesses within the site is £583,000.02.</p>
Occupier Profile (if partly developed, including % of available land and levels of vacancy onsite)	<p>Occupiers of the site include:</p> <ul style="list-style-type: none"> Porcelanosa (tiles, bathrooms and kitchen shop) Village Hotel (with spa) Canon Europa The Salvation Army Venson (Automotive Solutions) Lasershape (Precision Engineering) Smiths News Nationwide Crash Repair Centre Battlefront Miniatures Europe EMCS Ltd (Security Service) Basfords Ltd (Conservatory supply & installation) Portakabin (Portable building manufacturer) TS Autos (Van sales and garage services) AJW Motors Training in Electrical Ltd.

	The site contains one vacant unit (Unit 2, 5,194 sq ft. warehouse within a secured yard).	
Strategic Road Access	The site adjoins the A6005.	Average
Local Road Access	Barton Lane joins the site from the A6005 via a 4-arm roundabout.	Very Good
Proximity to Urban Areas and Access to Labour and Services (including public transport / cycling / walking accessibility)	<p>Located at the south-east edge of Toton, the site benefits from eatery and retail facilities within the immediate vicinity such as Tesco Express, Lidl, Corn Mill Pub, Fish and Chips shop and McDonalds.</p> <p>The site has good pedestrian infrastructure with connectivity to the wider area; however, the site does not benefit from any separate cycle lanes or shared cycleways. A large car park is also available for guests of the Village Hotel.</p> <p>Two bus stops are positioned immediately adjacent the site along the A6005 with services to Long Eaton, Briar Gate, Derby, Nottingham and The East Midlands Airport. Attenborough Railway Station is also located c.1.58km to the east of the site with services to Matlock, Newark Castle, Leicester, Derby and Nottingham.</p>	Very Good
Compatibility of Adjoining Uses (including amenity impacts experienced by current/future occupiers and neighbouring areas)	Immediately to the south of the site is an active railway line with Attenborough Nature Reserve beyond. The site's frontage runs along the A6005 with other retail complexes adjacent. Eldon Road Business Park borders the site to the east.	Very Good
Developmental and Environmental Constraints (e.g. size; topography; site access; roads, lighting, landscaping, mains utilities and communications infrastructure; flood risk; contamination; nature and heritage conservation)	<p>Ingress and egress to the site is off a 4-arm roundabout, Brailsford Way traverses through the site as the main spine road through the business park and is a no-exit road terminating by Smith News at the end of the site.</p> <p>To the south of the site is Attenborough Nature Reserve, a large wetland site designated within the Green Belt. Much of the site is designated within a Flood Zone 3 allocation with some areas of Flood Zone 2 towards the A6005 (Flood Maps for Planning – Gov.uk, 2020). The site contains sparsely vegetated borders running along the pavement lengths.</p>	Average
Barriers to Delivery and Mitigation (including ownership constraints -	The site is fully developed with no obvious barriers visible from the site visit.	Very Good

if known)		
Market Attractiveness (including appropriateness, vacancy and market activity on site for the type of development proposed)	<p>The site has a single vacancy advertised with the property agents Innes England. Unit 2 is 5,194 sq ft. with the property forming part of a larger unit sub-divided internally to provide a self-contained units with shared welfare facilities. The unit has been on the market since 7th October 2020 with an asking price of £27,000 pa. The agents describe the site as being on an ‘established business park’.</p> <p>To the rear of the Village Hotel, Paton.</p>	Good
Strategic Fit with Growth Area Objectives (by target Market Segment)	<p>The following industrial growth sectors are already located within the site;</p> <ul style="list-style-type: none"> • Creative & Digital • Visitor Economy • Construction • Professional/Business Service <p>The site is located on the border of the Nottingham ‘Regional Centre’ (as identified in the D2N2 Vision 2030 document).</p>	Good
OVERALL SITE RATING	Good	
Recommendation and Potential Future Uses	<p>Protect for employment uses</p> <p>Retain current Local Plan Part 2 Designation as an Employment Site</p> <p>The site is an established employment business park with high occupancy levels and surrounded by complimentary premises. The site is also within close proximity to urban areas and is well serviced by public transport and pedestrian infrastructure.</p>	
SITE SUMMARY:		
<p>The site is located to the south-east edge of Toton and approximately 9.8 km from Nottingham City Centre. The site contains a number of occupiers classified within C1, D1, E and F1 (a) use classes and employing a total of 236 individuals across the site. It is within the immediate vicinity of other employment areas such as Chilwell Retail Park, Eldon Road Business Park and West Point shopping centre with Chetwynd Barracks located to the north of the site. The site should retain its Local Plan allocation as an employment site, and it is recommended to protect the site for employment uses.</p>		

Eldon Road Business Park (Ref: BBC2)



GROSS SITE AREA:
4.63 ha

ESTIMATED NET DEVELOPABLE AREA:
0 ha

CRITERIA	COMMENT	RATING
<p>Site Context</p> <ul style="list-style-type: none"> • Location with regards to existing employment areas and other sites • How the site fits into the overall portfolio 	<p>The site is located at the south-east edge of the village of Toton, to the east of Long Eaton and approximately 9.3km from Nottingham City Centre. The site also neighbours Chilwell Retail Park, Eldon Road Business Park and West Point shopping centre with Chetwynd Barracks located to the north of the site.</p> <p>The site is identified within the adopted Local Plan as an Existing Employment site, neighbouring other employment areas in the immediate vicinity.</p>	
<p>Local Plan Designation</p>	<p>The site is designated as an Existing Employment Site: Eldon Road Business Park (Policy 9) within the Part 2 Local Plan (adopted October 2019).</p> <p>The site borders the Green Belt (Policy 8) to the south and west, with Attenborough Gravel Pits and Nature Reserve also to the south (Policy 28.1c; 28.1f; 31.2a). Barratt Lane Attenborough Conservation area also immediately borders the site to the east.</p>	
<p>Status in SHLAA</p>	<p>N/A</p>	
<p>Planning History</p>	<p>Recent planning history includes;</p> <ul style="list-style-type: none"> • 05/00152/FUL – Full planning application – Construct B1 Office Development – Granted 28.04.05 • 07/00466/FUL – Full planning application – Construct two storey car showroom – Granted 19.10.07 • 12/00371/ADV – Advertisement consent application – Display 3 No internally illuminated folded fascias, 1 No internally illuminated service sign, 1 No internally 	

	<p>illuminated totem and 1 No externally illuminated entrance garage – Granted 17.08.12</p> <ul style="list-style-type: none"> • 13/00197/FUL – Full planning application – Construct workshop extension (revised scheme) – Granted 31.05.13 • 16/00395/FUL – Full planning application – Construct detached car body repair workshop – Granted 10.11.16 • 16/00784/FUL – Full planning application – Change of use of Unit 18 Eldon Road from warehouse (Class B8) to general industrial (Class B2), external alterations and construct covered link from unit 19 Eldon Road to Unit 1 Brailsford Way – Granted 26.01.17 • 19/00321/FUL – Full planning application – Change of use from car body repair and paint workshop to car showroom – Granted 16.07.19 • 19/00729/FUL – Full planning application – Retention of car body repair workshop and construct single storey office extension – Granted 11.03.20
<p>Current Use and Land Type</p>	<p>An active business park comprising of industrial units and a modern red brick detached office complex defined within class E and B8 uses. The buildings are in a good/very good condition with the office units in the north-western section of the estate constructed in 2005/06.</p> <p>Business information provided by Broxtowe Borough Council (April 2019) notes the total employment floorspace throughout the site is 13,439.03 m² with 112 employees working within the Business Park</p> <p>The total rateable value of businesses within the site is £519,250.20</p>
<p>Occupier Profile (if partly developed, including % of available land and levels of vacancy onsite)</p>	<p>Occupiers of the site include:</p> <p>Davies Loss Adjusters 2BM Data Centre Solutions Open Retail Solutions Evo Energy Ltd Reynods Recruitment MAP Financial Solutions Ltd. ACR Supplies, Leisure Outlet / Holcrons Ltd KIA Motors MK Motors Pearson Bowling (chartered accountants and tax advisers) gK Abbot + co (chartered accountants & business advisers) DVLA Driving Test Centre KSM Head Office & Distribution (cable stockist and distributors for networking, audio, video and communication cables) Foster Care Associates Excellence Squared Limited (business consultants) Stepnell (construction contractors) The Hire Supply Company Chesney's Ltd Smiths Metal Centres Ltd</p>

	Lasershape Limited.	
Strategic Road Access	The site adjoins the A6005.	Average
Local Road Access	The site joins the A6005 from Eldon Road via a traffic light junction.	Very Good
Proximity to Urban Areas and Access to Labour and Services (including public transport / cycling / walking accessibility)	<p>Located at the south-east edge of Toton, the site benefits from eatery and retail facilities within the immediate vicinity such as Tesco Express, Lidl, Corn Mill Pub, Fish and Chips shop and McDonalds.</p> <p>The site has good pedestrian infrastructure with connectivity to the wider area, however the site does not benefit from any separate cycle lanes or shared cycle ways. The Office complex at the business park has some parking facilities for the employees based at the site.</p> <p>A bus stop is positioned immediately in front of the site on the A6005. The stop provides services to Beeston, Attenborough, Chilwell, Toton and Stapleford. Attenborough Railway Station is also located c.1km to the east of the site with services to Matlock, Newark Castle, Leicester, Derby and Nottingham.</p>	Very Good
Compatibility of Adjoining Uses (including amenity impacts experienced by current/future occupiers and neighbouring areas)	Immediately to the south of the site is an active railway line with Attenborough Nature Reserve beyond. The sites frontage runs along the A6005, with other retail complexes adjacent. Chilwell Meadows Business Park borders the site to the west.	Average
Developmental and Environmental Constraints (e.g. size; topography; site access; roads, lighting, landscaping, mains utilities and communications infrastructure; flood risk; contamination; nature and heritage conservation)	<p>Ingress and egress to the site is directly of the A6005 via a traffic light junction. Eldon Road acts a spine road through the site forming a no-through road and terminating at the Hire Supply Company.</p> <p>To the south of the site is Attenborough Nature Reserve, a large wetland site designated within the Green Belt. Much of the site is designated within a Flood Zone 3 allocation with some areas of Flood Zone 2 towards the A6005 (Flood Maps for Planning-Gov.uk, 2020). The landscape of the site is relatively void of vegetation but is well kept, particularly within the office court.</p>	Average
Barriers to Delivery and Mitigation (including ownership constraints - if known)	The site is fully developed with no obvious barriers noted from the site visit.	Very Good
Market Attractiveness	Four of the offices within the site are on the market	Good

<p>(including appropriateness, vacancy and market activity on site for the type of development proposed)</p>	<p>to let, with one for sale.</p> <p>NG Chartered Surveyors are advertising three separate offices to let: Unit 25 (2,063 sq. ft., £27,350 pa., 8 car parking spaces), 31 (926 sq. ft., £10,000 pa., 3 car parking spaces) and 32 (3,044 sq. ft., £42,500 pa.)</p> <p>Unit 21 is advertised with FHP (2,830 sq. ft, £40,000pa with price for purchase on application)</p> <p>The agents describe the offices as having an ‘excellent specification throughout’ within a ‘highly popular development’ which has good access to the city and M1 motorway.</p>	
<p>Strategic Fit with Growth Area Objectives (by target Market Segment)</p>	<p>The following industrial growth sectors are already located within the site:</p> <ul style="list-style-type: none"> • Creative & Digital • Construction • Professional/Business Service • Retail • Health/Social Care <p>The site is located on the border of Nottingham ‘Regional Centre’ (as identified in the D2N2 Vision 2030 document).</p>	<p>Good</p>
<p>OVERALL SITE RATING</p>	<p>Good</p>	
<p>Recommendation and Potential Future Uses</p>	<p>Protect for employment uses</p> <p>Retain current Local Plan Part 2 Designation as an Employment Site</p> <p>The site is an established business park and surrounded by complimentary premises. Marketing agents perceive the site favourably in respect of the building quality and proximity to the city centre and M1. The site is within close proximity to urban areas and is well serviced by public transport and pedestrian infrastructure</p>	
<p>SITE SUMMARY:</p>		
<p>The site is located to the south-east edge of Toton and approximately 9.8km from Nottingham City Centre. The site contains a number of occupiers classified within E and B8 use class, employing a total of 112 employees within the site and having a rateable value of £519,250.20. The site is also within the immediate vicinity of other employment areas such as Chilwell Retail Park, Eldon Road Business Park and West Point shopping centre with Chetwynd Barracks located to the north of the site. As an established business park that is also positively viewed by marketing agents the site should retain its current designation as an employment site, and it is recommended to protect the site for employment uses.</p>		

Gin Close Way (Ref: BBC3)



**GROSS SITE AREA:
6.47 ha**

**ESTIMATED NET DEVELOPABLE AREA:
0 ha**

CRITERIA	COMMENT	RATING
<p>Site Context</p> <ul style="list-style-type: none"> • Location with regards to existing employment areas and other sites • How the site fits into the overall portfolio 	<p>The site is located between the A6096 and A610 interchange, with Giltbrook village to the north-east and the village of Awsworth to the south-west.</p> <p>Within close proximity to adjoining trunk roads, Meadow Bank Court and Nottingham 26 are approximately 5.3km (c. 6-minute) drive, heading north-west along the A610. Giltbrook Shopping Park is also located across of the interchange (0.8km, c. 2-minute drive) to the north-east.</p>	
<p>Local Plan Designation</p>	<p>The site is allocated as an Existing Employment Site: Gin Close Way (Policy 9) within the Part 2 Local Plan (adopted October 2019).</p> <p>Part of the site is also located within the Green Belt (Policy 8) and adjacent to a site designated for land allocated as 'Housing Commitments' (Land at Gin Close Way, for 71 dwellings).</p>	
<p>Status in SHLAA</p>	<p>N/A</p>	
<p>Planning History</p>	<p>Recent planning history includes:</p> <ul style="list-style-type: none"> • 14/00549/FUL – Full planning application – Retain change of use of land and buildings from haulage depot to car wash and valet, car sales, car body repairs, storage of pallets and vehicles (including overnight parking), B2 workshop, parking and repair of commercial vehicles and ancillary offices, the site of self-storage containers, and the erection of a 2 metre green mesh metal fence to front boundary – Granted 17.12.14 	

	<ul style="list-style-type: none"> • 16/00659/FUL – Full planning application – Construct concrete batching planning, including demolition of existing concrete batching plant and all associated work – Granted 20.12.16 • 16/00635/FUL – Full planning application – Retain Caravan on site – Withdrawn 22.06.17 • 18/00196/CLUE – Certificate of lawfulness – Certificate of lawfulness for existing use as MOT testing station - Granted 09.05.18 • 19/00189/FUL – Full planning application – Retain four storage containers, PVC workshop tent and change of use of land to trade sales of caravans, campervans and similar vehicles with associated repair – Granted 06.09.19 • 19/00456/ADV – Advertisement consent application – Retain 2 non-illuminated advertisement signs – Granted 21.10.19 • 20/00403/FUL – Full planning application – Siting of 90 storage containers – Withdrawn 05.10.20 • 20/00626/FUL – Full planning application – Change of use of land to provide a vehicle parking/storage facility with landscaping and associated development – Granted 04.12.20
<p>Current Use and Land Type</p>	<p>The site comprises of class E, B2, B8 and Sui Generis premises. The buildings are in an average condition dating from the mid-90s to early 2000s.</p> <p>Business information provided by Broxtowe Borough Council (dated April 2019) notes the total employment floorspace throughout the site is 13,808.39 m² with 127 employees working within the site.</p> <p>The total rateable value of businesses within the site is £293,850.06.</p>
<p>Occupier Profile (if partly developed, including % of available land and levels of vacancy onsite)</p>	<p>Occupiers of the site include;</p> <p>Hand car wash TQT Ltd. Tyre Centre Your Storage R. Whitehead Concrete Oaktree Motor Homes Shell Petrol Garage Buildbase, Hire Base and Electrical Base Vocon Traffic Management O'Connor Utilities Ltd. The Gate Inn Total Vehicle Solutions Watson's Autos Raventstock MSG Ltd. (Portable Storage & Accommodation) Sandbrook Car Sales Amber Valley Classics (Lorry and Bus Restoration) Awsworth Motor Co Ltd Bridges Van Hire</p>

Strategic Road Access	Adjoins the A6096 with immediate access to the A610. Following the A610 east, the road connects with the M1 approximately 6.4km from the site.	Average
Local Road Access	Access from the A6096, with the south of the site only accessible from Main Street/Awsorth Lane. Awsorth Lane is a no-exit road and terminates beyond the site.	Average
Proximity to Urban Areas and Access to Labour and Services (including public transport / cycling / walking accessibility)	<p>The site is located to the south of the A610/A6096 interchange with Awsorth to south-west. There is very limited facilities in the immediate vicinity with the nearest available in either Ilkeston town (3.3km to the south-west) or within Eastwood (3.4km to the north-east). Overall, the site has very limited parking.</p> <p>Effectively, Gin Close Way is a 2-part site with the A6096 serving the site to the north and Main Street/Awsorth Lane to the south. The A6096 has good pedestrian infrastructure with a shared cycleway along the pavement. A public footway is also located at the top of the A6096 before the interchange that traverses under the A610 to Giltbrook or south-west towards Cotmanhay.</p> <p>2 bus stops are also positioned on the A6096 with services to Ikea, Kimberley, Swingate, Awsorth, Ilkeston and Larklands.</p> <p>Although pedestrianised, many cars are parked on the pavement along Main Street/Awsorth Lane therefore restricting walkability to the south. On entry to the south segment of the site much of the pavement disappears. In addition, there is no cycling infrastructure along Main Street/Awsorth Lane. A bus stop is located at the very top of Main Street with services to Ilkeston, Awsorth and Swingate.</p>	Average
Compatibility of Adjoining Uses (including amenity impacts experienced by current/future occupiers and neighbouring areas)	Although the site does not immediately adjoin residential dwellings, part of the site is located within the Green Belt.	Good / Very Good
Developmental and Environmental Constraints (e.g. size; topography; site access; roads, lighting, landscaping, mains utilities and communications infrastructure; flood risk;	The site is not fully accessible from a single access point, with the north of the site serviced by the A6096 and the south of the site served by Main Street/Awsorth Lane. The A6096 also divides the northern part of the site with crossing further	Average

contamination; nature and heritage conservation)	restricted due to the busyness of the road. Overall, the site is split into three parts. A clear constraint of the site is its location partially within the Green Belt.	
Barriers to Delivery and Mitigation (including ownership constraints - if known)	Should the site become available, remediation may be necessary, particularly within the R. Whitehead Concrete site.	Average
Market Attractiveness (including appropriateness, vacancy and market activity on site for the type of development proposed)	The site has no vacancies and is within close proximity to Giltbrook shopping centre, beyond the A610/A6096 interchange, to the north-east with national retailers such as IKEA, Next and Boots. The A610 adjacent also provides connectivity to the M1 motorway.	Average
Strategic Fit with Growth Area Objectives (by target Market Segment)	The following industrial growth sectors are already located within the site; <ul style="list-style-type: none"> • Construction The site is located on the border of the Nottingham 'Regional Centre' (as identified in the D2N2 Vision 2030 document).	Poor
OVERALL SITE RATING	Average	
Recommendation and Potential Future Uses	<p>Protect for employment uses</p> <p>Retain current Local Plan Part 2 Designation as an Employment Site</p> <p>The site is long established and has immediate access to trunk roads with good connectivity to the M1. An active and recent planning history indicates development interest in the site for its use as an industrial site and therefore it should retain its designation as an employment site.</p>	
SITE SUMMARY:		
<p>The site is located between the A6096 and A610 interchange, with Giltbrook village to the north-east and the village of Awsworth to the south-west. The site is fully occupied by a mix of businesses within the class E, B2, B8 and Sui Generis uses employing 127. The site is divided into three parts and is not accessible from a single access point, a clear constraint of the site's potential to expand is its location partially within the Green Belt and the housing commitments to the south-west. Given the longevity of the site and its recent planning history showing development interest for industrial uses, the site should retain its Local Plan allocation as an existing employment site, and it is recommended to protect the site for employment uses.</p>		

Beeston Business Park (1) (Ref: BBC4)



GROSS SITE AREA:
5.49 ha

ESTIMATED NET DEVELOPABLE AREA:
0 ha

CRITERIA	COMMENT	RATING
<p>Site Context</p> <ul style="list-style-type: none"> • Location with regards to existing employment areas and other sites • How the site fits into the overall portfolio 	<p>The site is located within the town of Beeston approximately 5.5 km south-west of Nottingham City Centre. To the north-east is the University of Nottingham's main campus, whilst the pharmaceutical and retail chemist group Boots has its headquarters c.1km to the east.</p> <p>The site forms part of a modern mixed-use employment area along Technology Drive, with the segmented development of Beeston Business Park and construction of dwellings to the east.</p> <p>In total, there are three designated Enterprise Zones across Nottingham, and Beeston Business Park is one of the three designated zones.</p>	
<p>Local Plan Designation</p>	<p>The site is allocated as an <i>Existing Employment Site: Beeston Business Park</i> (Policy 9) within the Part 2 Local Plan (adopted October 2019).</p> <p>The site borders a Nature Reserve to the west (Attenborough Gravel Pits), Trent Vale Allotments to the south and Housing Commitments (Beeston Business Park, 310 dwellings) to the east.</p>	
<p>Status in SHLAA</p>	<p>Reference 499 (Beeston Business Park Technology Drive Beeston, for 310 dwellings)</p>	
<p>Planning History</p>	<p>Recent planning history includes:</p> <ul style="list-style-type: none"> • 14/00242/FUL - Hybrid planning application comprising: Full application for industrial, storage and distribution buildings (Use Classes B1 b and c, B2 and B8), land for school expansion (Class D1), car parking 	

	<p>and associated road infrastructure. Outline application for up to 310 residential units and community building with means of access included (all other matters reserved) – Granted 03.11.17</p> <ul style="list-style-type: none"> • 19/00490/FUL – Construct entrance feature incorporating an entrance canopy – Granted 11.09.19 	
Current Use and Land Type	<p>This is a brownfield site occupied by Beeston Business Park, a modern and newly constructed Park comprising of Class E offices.</p> <p>Business information provided by Broxtowe Borough Council (dated April 2019) notes the total floorspace throughout the wider Beeston Business Park is 24,173 sqm with 162 employees working within the site.</p>	
Occupier Profile (if partly developed, including % of available land and levels of vacancy onsite)	<p>The site is dominated by Waterfront House which houses Worldwide Clinical Trials, Go Daddy and Metropolitan Thames Valley Housing. Other occupiers of the site include AW Repair Group, SMS Product Services and SMS Electronics. There is also a large surface car park associated with these businesses.</p>	
Strategic Road Access	<p>950m to the south-west of the A6005 from Meadow Road/Station Road.</p>	Poor
Local Road Access	<p>Access from Station Road/Meadow Road through residential roads passing a nursery and care home.</p> <p>Technology Drive itself has restricted access controlled via a gated security barrier.</p>	Poor
Proximity to Urban Areas and Access to Labour and Services (including public transport / cycling / walking accessibility)	<p>The site is within walking distance of Beeston Town centre and a short walk from Beeston train station with services to Birmingham New Street, St Pancras International, Matlock, Newark Castle, Lincoln, Cardiff Central, Leicester and Nottingham.</p> <p>As a newly developed complex the site has excellent pedestrian infrastructure and a shared cycleway running along Meadow Road. Technology Drive also benefits from a long stay car park beside the train station.</p>	Very Good
Compatibility of Adjoining Uses (including amenity impacts experienced by current/future occupiers and neighbouring areas)	<p>The site is bound by Technology Drive to the north with the railway beyond, residential development to the east, allotments to the south and a lake to the west.</p>	Average

<p>Developmental and Environmental Constraints (e.g. size; topography; site access; roads, lighting, landscaping, mains utilities and communications infrastructure; flood risk; contamination; nature and heritage conservation)</p>	<p>This is a level site within a new Business Park, it has gated access along technology drive with infrastructure and utilities in place.</p> <p>A review of Flood Maps for Planning (Gov.uk, 2021) shows the site is located within a Flood Zone 2.</p>	<p>Average / Good</p>
<p>Barriers to Delivery and Mitigation (including ownership constraints - if known)</p>	<p>This site is fully occupied with no vacant units and benefits from Enterprise Zone status.</p>	<p>Very Good</p>
<p>Market Attractiveness (including appropriateness, vacancy and market activity on site for the type of development proposed)</p>	<p>The site is newly developed with no vacancies; the development is also very well connected in particular benefiting from the adjoining train station with national rail services.</p>	<p>Very Good</p>
<p>Strategic Fit with Growth Area Objectives (by target Market Segment)</p>	<p>The following industrial growth sectors are already located within the site;</p> <ul style="list-style-type: none"> • Creative & Digital • Health/Social Care • Professional/Business Service <p>The site is located on the border of the Nottingham 'Regional Centre' (as identified in the D2N2 Vision 2030 document).</p>	<p>Very Good</p>
<p>OVERALL SITE RATING</p>	<p>Very Good</p>	
<p>Recommendation and Potential Future Uses</p>	<p>Protect for employment uses</p> <p>Retain Current Local Plan Part 2 Designation as an Employment Site</p> <p>The site benefits from Enterprise Zone status and forms part of a modern business park benefitting from good transport connectivity, on the border of the Nottingham 'Regional Centre' with complimentary employment areas in the locality the site should retain its designation as an employment site.</p>	
<p>SITE SUMMARY:</p>		
<p>The site is located in the town of Beeston and within relatively close proximity to the University of Nottingham's main campus and Boots HQ. The site benefits from excellent transport connectivity, particularly the convenient train station providing services locally and to major stations in the national network. As a modern business park that benefits from Enterprise Zone status; is newly constructed with all the amenities; in full occupation; that borders the Nottingham 'Regional Centre' designation, the site should retain its Local Plan allocation as an existing employment site, and it is recommended to protect the site for employment uses.</p>		

Beeston Business Park (2) (Ref: BBC5)



GROSS SITE AREA:
1.54 ha

ESTIMATED NET DEVELOPABLE AREA:
0 ha

CRITERIA	COMMENT	RATING
<p>Site Context</p> <ul style="list-style-type: none"> • Location with regards to existing employment areas and other sites • How the site fits into the overall portfolio 	<p>The site is located within the town of Beeston approximately 10km south-west of Nottingham City Centre. To the north-east is the University of Nottingham's main campus and the pharmaceutical and retail chemist group Boots has its headquarters approximately 1km to the east.</p> <p>The site forms part of a modern mixed-use employment area along Technology Drive, with the segmented development of Beeston Business Park and construction of dwellings to the south.</p> <p>In total, there are three designated Enterprise Zones across Nottingham, of which Beeston Business Park is one.</p>	
<p>Local Plan Designation</p>	<p>The site is allocated as an Existing Employment Site: Beeston Business Park (Policy 9) within the Part 2 Local Plan (adopted October 2019).</p> <p>The site borders further 'Employment Commitment' (Beeston Business Area) to the west and 'Housing Commitment' (Beeston Business Park, 310 dwellings) to the south.</p>	
<p>Status in SHLAA</p>	<p>Reference: 499 (Beeston Business Park Technology Drive Beeston, for 310 dwellings)</p>	
<p>Planning History</p>	<p>Recent planning history includes:</p> <ul style="list-style-type: none"> • 07/00255/FUL – Full planning application – Construct three storey office building (Class B1) with associated car parking, landscaping and access – Granted 02.07.07 • 07/00757/OUT – Outline application – Outline application for employment development (Classes B1/B2/B8), comprising up to 61,366 sqm floorspace, 	

	<p>including up to 30,723m² B1 (a) office, demolition of 47,267m² existing buildings with details of access unreserved – Withdrawn 30.11.07</p> <ul style="list-style-type: none"> • 08/00505/OUT – Outline application – Outline application for employment development (Classes B1/B2/B8), comprising up to 61,366m² floorspace, including up to 30,723m² B1(a) office, demolition of 47,267m² existing building with details of access unreserved (revised scheme) – Withdrawn 31.12.10 • 14/00242/FUL – Hybrid planning application comprising: Full application for industrial, storage and distribution buildings (Use Classes B1 b and c, B2 and B8), land for school expansion (Class D1), car parking and associated road infrastructure. Outline application for up to 310 residential units and community building with means of access included (all other matters reserved) – Granted 03.11.17
Current Use and Land Type	<p>The site is part of the newly constructed Beeston Business Park, occupied by a single modern office unit, a Class E business (ATOS Worldwide).</p> <p>Business information provided by Broxtowe Borough Council (April 2019) note the total floorspace throughout the wider Beeston Business Park is 24,173 sqm with 162 employees.</p>
Occupier Profile (if partly developed, including % of available land and levels of vacancy onsite)	<p>The site is fully occupied by ATOS Worldline, a company specialising in electronic payment services including issuing, acquiring terminals and card and non-card payment solutions and transactions.</p>
Strategic Road Access	<p>300m to the south-west of the A6005 from Meadow Road/Station Road</p> <p>Poor</p>
Local Road Access	<p>Access from Station Road/Meadow Road through residential roads passing a nursery and care home.</p> <p>Poor</p>
Proximity to Urban Areas and Access to Labour and Services (including public transport / cycling / walking accessibility)	<p>The site is within walking distance to Beeston town centre and a very short walk from Beeston train station with services to Birmingham New Street, St Pancras International, Matlock, Newark Castle, Lincoln, Cardiff Central, Leicester and Nottingham.</p> <p>As a newly developed complex the site has good pedestrian infrastructure and a shared cycleway runs along Meadow Road. Technology Drive also benefits from a long stay y car park located beside the train station.</p> <p>Very Good</p>

<p>Compatibility of Adjoining Uses (including amenity impacts experienced by current/future occupiers and neighbouring areas)</p>	<p>The site is bound to the north by Technology Drive with the railway and Beeston Railway Station beyond. To the north-east is a long stay car park with modern industrial units at Beeston Business Park to the west. A new residential development also borders the site to the south (Barratt Homes – Beeston Quarter)</p> <p>The site benefits from a gated, level surfaced car park for employees and visitors.</p>	<p>Average</p>
<p>Developmental and Environmental Constraints (e.g. size; topography; site access; roads, lighting, landscaping, mains utilities and communications infrastructure; flood risk; contamination; nature and heritage conservation)</p>	<p>This is a small and irregularly-shaped site. As a newly constructed development the site is level and benefits from infrastructure and utility connections.</p> <p>A review of Flood Maps for Planning (Gov.uk, 2021) shows the site is located within a Flood Zone 2.</p>	<p>Average / Good</p>
<p>Barriers to Delivery and Mitigation (including ownership constraints - if known)</p>	<p>This site is fully occupied with no vacant units and benefits from Enterprise Zone status.</p>	<p>Very Good</p>
<p>Market Attractiveness (including appropriateness, vacancy and market activity on site for the type of development proposed)</p>	<p>The site is newly developed having no vacancies, the development is also very well-connected adjoining the train station.</p>	<p>Very Good</p>
<p>Strategic Fit with Growth Area Objectives (by target Market Segment)</p>	<p>The following industrial growth sectors are already located within the site;</p> <ul style="list-style-type: none"> Professional/Business Service <p>The site is located on the border of the Nottingham ‘Regional Centre’ (as identified in the D2N2 Vision 2030 document).</p>	<p>Good</p>
<p>OVERALL SITE RATING</p>	<p>Very Good</p>	
<p>Recommendation and Potential Future Uses</p>	<p>Protect for employment uses</p> <p>Retain current Local Plan Part 2 Designation as an Employment Site</p> <p>The site benefits from Enterprise Zone status and forms part of a modern business park benefitting from excellent transport connectivity, on the border of the Nottingham ‘Regional Centre’ with complementary employment areas in the locality, the site should retain its protection as an employment site.</p>	
<p>SITE SUMMARY:</p>		
<p>The site is located in the town of Beeston and within relatively close proximity to the University of Nottingham’s main campus and Boots HQ. The site benefits from excellent transport connectivity,</p>		

particularly the highly accessible train station providing services locally and to major stations in the national network. As a modern business park that benefits from Enterprise Zone status; is newly constructed with all the amenities; bordering the Nottingham 'Regional Centre' designation, the site should retain its Local Plan allocation as an existing employment site, and it is recommended the site be protected for employment uses.

Padge Road, Boulevard Industrial Park (Ref: BBC6)



GROSS SITE AREA:
5.53 ha

ESTIMATED NET DEVELOPABLE AREA:
0 ha

CRITERIA	COMMENT	RATING
<p>Site Context</p> <ul style="list-style-type: none"> • Location with regards to existing employment areas and other sites • How the site fits into the overall portfolio 	<p>The site is located within the town of Beeston, approximately 6.4 km south-west of Nottingham City Centre. To the north-east is the University of Nottingham's main campus and the pharmaceutical and retail chemist group Boots has its headquarters immediately to the south-east.</p> <p>The site forms part of a larger employment area comprising of Boots and Lilac Grove (to the south), Evelyn Street (to the north) and a number of industrial and retail employment areas in Nottingham to the east.</p>	
<p>Local Plan Designation</p>	<p>The site is allocated as an Existing Employment Site: Padge Road, Boulevard Industrial Park (Policy 9) within the Part 2 Local Plan (adopted October 2019).</p> <p>Across the railway line to the south are two additional employment sites, Boots and Lilac Grove (Policy 9) with employment commitments also allocated at Boots. To the north, Evelyn street is also designated as an Existing Employment Site (Policy 9).</p>	
<p>Status in SHLAA</p>	<p>N/A</p>	
<p>Planning History</p>	<p>Recent planning history includes:</p> <ul style="list-style-type: none"> • 05/00177/FUL – Full planning application – Construct entrance porch/new reception – Granted 20.04.05 • 19/00404/FUL – Full planning application – Change of use from office (Class B1) to dementia activity 	

	centre (Class D1) – Granted 22.08.19	
Current Use and Land Type	<p>Industrial units with relatively modern office complexes comprising of Class E, B2 and B8 uses. The office buildings are two-storey block semi-detached premises in a good condition with car parking facilities. The industrial units are also in a good condition.</p> <p>Business information provided by Broxtowe Borough Council (April 2019) notes the total employment floorspace of the site is 27,061 sqm with 83 employed across the site.</p>	
Occupier Profile (if partly developed, including % of available land and levels of vacancy onsite)	<p>The site is occupied by:</p> <p>CWCS Managed Hosting (offices) DAF Motus Commercials VW Nottingham Van Centre Barrowcliffes Cooking and KMS Kettle Meal Solutions Nottinghamshire County Council EMT Healthcare Limited HomeInstead Senior Care The Studio Royal Mail (Beeston Delivery Office) Network Rail</p>	
Strategic Road Access	The site is 150m to the south of the A6005 from Beacon Road.	Average
Local Road Access	Access from Beacon Road/Humber Road, passing through residential areas.	Average / Poor
Proximity to Urban Areas and Access to Labour and Services (including public transport / cycling / walking accessibility)	<p>Padge Road is approximately 1.6 km from Beeston Town Centre that contains national retail brands such as a Tesco Extra and Sainsbury's.</p> <p>At the top of Padge Road, along Beacon Road and adjacent the sites entrance is located two bus stops with services to Nottingham, QMC The University Campus, Rylands, Beeston, Bramcote and Stapleford.</p> <p>The site is pedestrianised throughout and connects into the wider area. The site is also in relatively close proximity to Beeston Railway Station (approximately 1.7km to the west) providing services to Birmingham New Street, St Pancras International, Matlock, Newark Castle, Lincoln, Cardiff Central, Leicester and Nottingham.</p>	
Compatibility of Adjoining Uses (including amenity impacts experienced by current/future occupiers and neighbouring areas)	The site is bound by a residential area to the north, separated by a narrow hedgerow border. A second residential area also neighbours the site across Beacon Road. The site is bound by a railway line to the south with a yard depot for	Poor

	National Rail use and Highfields Park (including Highfields Sports Complex) to the east.	
Developmental and Environmental Constraints (e.g. size; topography; site access; roads, lighting, landscaping, mains utilities and communications infrastructure; flood risk; contamination; nature and heritage conservation)	<p>The site is rectangular in shape with Padge Road a no-exit road, terminating at the end of the site by the Royal Mail delivery office. Padge Road also has a single ingress and egress from Beacon Road that adjoins a mini-roundabout on entry.</p> <p>A review of Flood Maps for Planning (Gov.uk, 2021) shows the premises near the entrance of the site are located within a Flood Zone 2.</p>	Good
Barriers to Delivery and Mitigation (including ownership constraints - if known)	The site is well established with few vacancies.	Very Good
Market Attractiveness (including appropriateness, vacancy and market activity on site for the type of development proposed)	<p>The office complex contains two vacant units to let. The offices are self-contained with open plan design spread across two-floors. Car parking is also provided within a shared parking area to the front.</p> <p>The offices are marketed by local agents Musson Liggins and Geo Hallam & Sons for the lease of:</p> <ul style="list-style-type: none"> • 1,393 sq. ft. of office space, at £20,000 pa • 1,115 sq. ft. of office space, at £17,000 pa <p>A second property, ground floor offices at Media House, are also available to let. The premises comprise of 4850 sq. ft. of office space at a price of £70,000 pa. The site also benefits from 22 allocated on-site parking spaces.</p> <p>The site is currently on the market with two agents including FHP and Innes England.</p>	Good
Strategic Fit with Growth Area Objectives (by target Market Segment)	<p>The following industrial growth sectors are already located within the site:</p> <ul style="list-style-type: none"> • Food & Drink Manufacturing • Creative & Digital • Logistics & E-Commerce • Retail • Health/Social Care • Professional/Business Service <p>The site is located on the border of the Nottingham 'Regional Centre' (as identified in the D2N2 Vision 2030 document).</p>	Very Good
OVERALL SITE RATING	Good	

<p>Recommendation and Potential Future Uses</p>	<p>Protect for employment uses</p> <p>Retain current Local Plan Part 2 Designation as an Employment Site</p> <p>The site forms part of a larger employment area with the businesses occupying the site operating across a number of the D2N2 targeted industrial growth sectors.</p> <p>The site should retain its current protected designation as an employment site.</p>
--	--

SITE SUMMARY:

The site is located within relatively close proximity to the University of Nottingham’s main campus and Boots HQ with Padge Road forming part of the wider employment area. The occupiers of the site include Class E, B2 and B8 premises such as the Royal Mail Delivery Office, VW Nottingham Van Centre, Nottingham County Council, Network Rail and EMT Healthcare Limited. In total, the site fulfils six of the D2N2 targeted industrial growth sectors. Given its fit with the growth sectors in this well established and popular location the site should retain its Local Plan allocation as an existing employment site, and it is recommend to protect the site for employment uses.

Lilac Grove (Ref: BBC7)



**GROSS SITE AREA:
7.53 ha**

**ESTIMATED NET DEVELOPABLE
AREA:
0 ha**

CRITERIA	COMMENT	RATING
<p>Site Context</p> <ul style="list-style-type: none"> • Location with regards to existing employment areas and other sites • How the site fits into the overall portfolio 	<p>The site is located within the town of Beeston, approximately 6.6km south-west of Nottingham City Centre. To the north-east is the University of Nottingham's main campus and the pharmaceutical and retail chemist group Boots has its headquarters immediately to the east.</p> <p>The site forms part of a larger employment area comprising of Evelyn Street and Padge Road (to the north), Boots (to the east) and a number of industrial and retail employment areas in Nottingham beyond.</p>	
<p>Local Plan Designation</p>	<p>The site is allocated as an 'Existing Employment Site: Lilac Grove' (Policy 9) within the Part 2 Local Plan (adopted October 2019).</p> <p>Across the railway line to the north are two additional employment sites, Evelyn Street and Padge Road (Policy 9), with employment commitments designated adjacent at Boots.</p> <p>The site borders an allocation for 258 dwellings to the south (Reference 258, Land at Lilac Grove).</p>	
<p>Status in SHLAA</p>	<p>N/A</p>	
<p>Planning History</p>	<p>Recent planning history includes:</p> <ul style="list-style-type: none"> • 10/00145/FUL – Full planning application – Install nitrogen storage vessel – Granted 16.04.10 • 11/00135/FUL – Full planning application – 	

	<p>Construct warehouse (Class B8) – Granted 28.04.11</p> <ul style="list-style-type: none"> • 12/00323/FUL – Full planning application – Construct new entrance lobby, make alterations to car park and erect external lighting. Relocate smoking shelter, remove and replace air conditioning units. – Granted 21.08.12 • 16/00261/FUL – Install extraction flue from cleaning tanks – Granted 14.07.16 • 18/00280/FUL – Construct 3 light industrial units (use class B1) following demolition of existing building – Granted 13.12.18 • 19/00718/FUL – Full planning application – Construct extension to provide frozen storage facility and provision of refrigeration plant – Granted 22.01.20 	
Current Use and Land Type	<p>The site includes Class E, B2, B8 and Sui Generis uses. The buildings are in a good condition and vary in age from modern units to early 1990s buildings.</p> <p>Business information provided by Broxtowe Borough Council (April 2019) notes the total employment floorspace throughout Lilac Grove is 31,984 sqm with 504 employees working across the site.</p>	
Occupier Profile (if partly developed, including % of available land and levels of vacancy onsite)	<p>The site is occupied by:</p> <p>The Floor Covering Distributors Lilac Grove Garage with Autocentre (at the rear of the property) Car Wash Cromwell (Industrial Tools) Acrylic Sheet Direct Marlin Plastics MidFix (fixing suppliers & pipe supports) Highway Automotive Centre Reeling Products Ltd (independent supplier of cable reel and hose reels) J. Tomlinson (Construction Company) BW Flexible Systems (Packaging Company) Freshcut Foods</p>	
Strategic Road Access	Adjoins the A6005 via Humber Road/Beacon Road	Average / Poor
Local Road Access	The site is accessed from Lilac Grove to the south-west or Humber Road to the north east off a 3-armed roundabout. The Lilac Grove route passes through residential areas and acts as a spine road through the site.	Average / Poor
Proximity to Urban Areas and Access to Labour and Services (including public transport /	Lilac Grove is approximately 1.5km from Beeston Town Centre that contains national retail brands	Very Good

<p>cycling / walking accessibility)</p>	<p>such as a Tesco Extra and Sainsbury's.</p> <p>The site benefits from a shared pedestrian cycleway through site with three bus stops positioned on Lilac Grove. The buses servicing Lilac Grove provide transport to Stapleford, Bramcote, Beeston, Rylands, The University Campus, QMC and Nottingham.</p> <p>The site is in relatively close proximity to Beeston Railway Station, located approximately 1.1km to the west providing services to Birmingham New Street, St Pancras International, Matlock, Newark Castle, Lincoln, Cardiff Central, Leicester and Nottingham.</p>	
<p>Compatibility of Adjoining Uses (including amenity impacts experienced by current/future occupiers and neighbouring areas)</p>	<p>To the immediate east of the site, Lilac Grove borders Trade Partners International (Building materials supplier), Beeston Household Recycling Centre and a sewage works. Part of the southern area of the site backs onto the sewage works with allotments also adjoining the southern border. A n active railway line constrains the site along the northern border with a residential area immediately neighbouring the site to the west.</p>	<p>Average / Poor</p>
<p>Developmental and Environmental Constraints (e.g. size; topography; site access; roads, lighting, landscaping, mains utilities and communications infrastructure; flood risk; contamination; nature and heritage conservation)</p>	<p>The site is regular in shape with ingress and egress directly off the main road, running as a spine road through the site.</p> <p>A review of Flood Maps for Planning (Gov.uk, 2021) shows the majority of the site is located within Flood Zone 2.</p>	<p>Average</p>
<p>Barriers to Delivery and Mitigation (including ownership constraints - if known)</p>	<p>An established site with a single vacant unit.</p>	<p>Very Good</p>
<p>Market Attractiveness (including appropriateness, vacancy and market activity on site for the type of development proposed)</p>	<p>Formerly Metools, the detached industrial building with two storey office accommodation towards the front of the site is vacant and advertised as being to let with Innes England.</p> <p>The property is 12,810 sq. ft. in size, with 3-phase power, mains gas supply and a 3-tonne gantry crane. The agents describe the industrial site as an established location close to arterial routes.</p>	<p>Good</p>
<p>Strategic Fit with Growth Area Objectives (by target Market Segment)</p>	<p>The following industrial growth sectors are already located within the site:</p> <ul style="list-style-type: none"> • Food & Drink Manufacturing • Construction <p>The site is located on the border of the</p>	<p>Average</p>

	Nottingham 'Regional Centre' (as identified in the D2N2 Vision 2030 document).	
OVERALL SITE RATING	Good	
Recommendation and Potential Future Uses	<p>Protect for employment uses</p> <p>Retain current Local Plan Part 2 Designation as an Employment Site</p> <p>The site forms part of a larger employment area and has high occupancy levels. The site should retain its protected designation as an employment site.</p>	
SITE SUMMARY:		
<p>The site is located within close proximity to the University of Nottingham's main campus and Boots' HQ. The site has very good transport connectivity, being serviced by multiple bus stops on several routes and within close proximity to Beeston Railway Station.</p> <p>The site contains a mix of established businesses, of which some are identified within two of D2N2 industrial growth sector priorities. The site should retain its Local Plan allocation as an existing employment site, and it is recommended to protect the site for employment uses.</p>		

Boots Campus (Ref: BBC8)



**GROSS SITE AREA:
9.12 ha**

**ESTIMATED NET DEVELOPABLE AREA:
0 ha**

CRITERIA	COMMENT	RATING
<p>Site Context</p> <ul style="list-style-type: none"> • Location with regards to existing employment areas and other sites • How the site fits into the overall portfolio 	<p>The site is located within the town of Beeston on the border with Nottingham City Council.</p> <p>The site is approximately 7.0 km south-west of Nottingham City Centre. To the north-east is the University of Nottingham's main campus and the site itself forms part of the larger Boots HQ.</p> <p>The site is also part of a larger employment area comprising of Evelyn Street and Pudge Road (to the north), Riverside/Lenton Lane industrial area (to the west) and Lilac Road (to the east).</p>	
<p>Local Plan Designation</p>	<p>The site is allocated as an <i>Employment Commitment: Boots</i> within Part 2 Local Plan (adopted October 2019).</p> <p>The surrounding land to the east is allocated as <i>Existing Employment Site: Boots</i> (Policy 9) and to the west <i>Existing Employment Site: Lilac Grove</i> (Policy 9). To the south of the site is allocated <i>Housing Commitment: Boots</i>, for 400 dwellings.</p>	
<p>Status in SHLAA</p>	<p>Reference; 237 (for 400 potential dwellings)</p>	
<p>Planning History</p>	<p>Recent planning history includes:</p> <ul style="list-style-type: none"> • 08/00267/FUL – Full planning application – Install glazing between existing columns to enlarge existing packing hall • 16/00838/LBC – Listed building consent – Internal refurbishment to include subdivision to middle of 3rd floor of D6 – Granted 12.05.08 	

	<ul style="list-style-type: none"> • 16/00847/LBC – Listed building consent – Replace existing concrete roof in 3 places with removable panels – Withdrawn 27.02.17 • 17/00487/LBC – Listed building consent – To install fire rated screen to reception area – Granted 17.11.17 • 18/00848/LBC – Listed building consent – To construct external link between D1 and D10, infill part of D10 south dock and alterations to the ground flood of D10 including insertion of false ceiling and internal walls and removal of glazed wall section – Granted 17.05.19 • 19/00650/FUL – Full planning application – Construct storage yard area with canopy – Withdrawn 24.10.19 <p>The following applications relate to land immediately south and east of the site off Thane Road:</p> <p>At Nottingham City Council’s Planning Committee Meeting on the 17th December 2014 it was resolved to grant outline planning permission (ref. 14/02038/POUT) for mixed-use development comprising: up to 82,000 sqm of employment floorspace, comprising office units (E), research and development (E), industrial process (E), general industrial (B2), storage and distribution (B8), residential institutions (C2) & non-residential institutions (D1), up to 2,500sqm retail & food/drink (A1, A2, A3, A4 and A5), up to 675 residential units (C3), and associated works including demolition of existing structures, earthworks, remediation, access, car parking, pedestrian and cycle routes, open space, utilities and sustainable drainage systems.</p> <p>Detailed planning permission (ref. 14/02039/PFUL3) was also granted in December 2014 for site and public infrastructure works including highways (primary vehicle link route, Alliance Boots vehicle access), new canal bridge, associated demolition works, earthworks, remediation, utilities and drainage infrastructure. This has been implemented and the new road is complete and subject to adoption.</p>
<p>Current Use and Land Type</p>	<p>The site forms part of the wider Boots national headquarters site for class E, B2 and B8 use. In March 2011, the Boots site was awarded Enterprise Zone status by the UK Government.</p> <p>Business information provided by Broxtowe Borough Council (April 2019) details 1,980 individuals as being employed within the wider Boots site.</p>
<p>Occupier Profile (if partly developed, including % of available land and levels of vacancy onsite)</p>	<p>The site is occupied by buildings D95, D6, D10, D1, and D25 buildings occupied by Boots and the following businesses:</p> <ul style="list-style-type: none"> • Reckitt Benckiser (manufacturer of health products) in building D95;

	<ul style="list-style-type: none"> • MediCity (a collaboration between Boots and BioCity, it is an incubator for healthcare start-ups) in building D6; • BCM Limited (manufacturer of cosmetics) in building D10 and D1. Albeit of the total c. 74,322 sqm, BCM have handed back approximately 27,871 sqm to Boots. <p>The Medical Technologies Innovation Facility (MTIF) (research centre for Nottingham Trent University) and former Boots fire station (Grade II Listed) is located immediately west of the site.</p>	
Strategic Road Access	The site adjoins Humber Road/Lilac Grove off a 4-armed round about. Humber Road traverses to the A6005 approximately 0.80km to the north-west passing through a residential area.	Average / Poor
Local Road Access	The local road passes through the Beeston Gate gated barrier to access the site, adjoining a 3-armed roundabout within the site. The wider Boots site can also be accessed off the A52 Clifton Boulevard to the east via the Thane Road gate. HGV access to the site is via the Harrimans Lane gate to the north.	Average
Proximity to Urban Areas and Access to Labour and Services (including public transport / cycling / walking accessibility)	<p>Boots' Campus is approximately 2.0km from Beeston Town Centre that contains national retail brands such as a Tesco Extra and Sainsbury's.</p> <p>The site is pedestrianised throughout and connecting into the wider area. The pedestrian infrastructure is also shared with a cycleway on exit from the site. The site is also in relatively close proximity to Beeston Railway Station (approximately 1.64km to the west) providing services to Birmingham New Street, St Pancras International, Matlock, Newark Castle, Lincoln, Cardiff Central, Leicester and Nottingham.</p> <p>There are bus stops within the wider site on C Road and Fifth Avenue with services every 10 minutes to Nottingham. There are also bus stops on Lilac Grove with services to Nottingham every 10 minutes as well as to Beeston and Stapleford. University Boulevard Tram Stop is also approximately 1km north of the site.</p>	Very Good
Compatibility of Adjoining Uses (including amenity impacts experienced by current/future occupiers and neighbouring areas)	The site forms part of the wider Boots HQ site. The site is bound by an active railway line to the north and the wider Boots site to the east including a private road with car parking facilities and the site power station. To the west there are parking facilities associated with the Boots site	Very Good

	and the Lilac Grove Sewage Treatment Works beyond. To the south there is development land with the recently completed road and bridge across the Beeston Canal beyond.	
Developmental and Environmental Constraints (e.g. size; topography; site access; roads, lighting, landscaping, mains utilities and communications infrastructure; flood risk; contamination; nature and heritage conservation)	<p>This site comprises the western portion of the wider Boots site. It has utilities and telecommunications infrastructure in place, there is also an onsite power station immediately to the east of this site.</p> <p>The D6 Building (occupied by MediCity) is Grade I Listed (ref. 1278028) and the D10 Building (occupied by BCM Limited) is Grade I Listed (ref. 1247927). Building D34 former fire station adjacent is Grade II Listed (ref. 1247933) and the Boots D90 West Headquarters Building to the west is Grade II* Listed (ref. 1268303).</p> <p>The Beeston Sidings Local Nature Reserve (ref. 1009534) is located immediate north of the railway line to the north of the site.</p> <p>The site is adjacent to the Beeston Canal and the entire site is within “<i>Flood Zone 3 Areas benefitting from flood defences</i>”.</p>	Poor
Barriers to Delivery and Mitigation (including ownership constraints - if known)	The site is fully developed although the constraints identified above will need to be addressed if redevelopment takes place.	Average
Market Attractiveness (including appropriateness, vacancy and market activity on site for the type of development proposed)	The site is fully occupied by Boots and a number of healthcare manufacturing and research businesses.	Very Good
Strategic Fit with Growth Area Objectives (by target Market Segment)	<p>The following industrial growth sectors are already located within the site;</p> <ul style="list-style-type: none"> • Health/Social Care <p>The site is located on the border of the Nottingham ‘Regional Centre’ (as identified in the D2N2 Vision 2030 document).</p>	Very Good
OVERALL SITE RATING	Very Good	
Recommendation and Potential Future Uses	<p>Protect for employment uses</p> <p>Retain current Local Plan Allocation as an Employment Commitment</p>	
SITE SUMMARY:		
The site is located within the town of Beeston and is located on the border with Nottingham City		

Council. The site itself forms part of the larger Boots HQ employing a total of 1,980 people. The site is also part of a larger employment area comprising of Evelyn Street and Padge Road (to the north), Riverside/Lenton Lane industrial area (to the west) and Lilac Road (to the east).

The site is occupied by buildings D95, D6, D10, D1, and D25 occupied by Boots as well as healthcare manufacturing/research and development facilities Reckitt Benckiser, MediCity and BCM Limited.

Land immediately south of the site has detailed planning permission for a new road (implemented) and outline planning permission for 82,000 sqm of employment floorspace, up to 2,500sqm retail & food/drink and up to 675 residential units.

The site is allocated as an *Employment Commitments: Boots* within the Part 2 Local Plan (adopted October 2019). It is recommended that the site is protected for employment uses to protect the Boots Head Quarters and the other valuable healthcare businesses located on the site.

Cossall Industrial Estate (Ref: BBC9)



**GROSS SITE AREA:
4.88 ha**

**ESTIMATED NET DEVELOPABLE
AREA:
0 ha**

CRITERIA	COMMENT	RATING
<p>Site Context</p> <ul style="list-style-type: none"> • Location with regards to existing employment areas and other sites • How the site fits into the overall portfolio 	<p>The site is located between the town of Ilkeston and the village of Awsworth. The site is bound by fields to the south with allotments and Chatterley House Hotel across Coronation Road to the north.</p> <p>To the north west, across the railway bridge, is Ilkeston train station (c.0.35km) and Digby Street Industrial Estate with Waterside Retail Park beyond.</p>	
<p>Local Plan Designation</p>	<p>The site is allocated as an '<i>Existing Employment Site: Cossall Industrial Estate</i>' (Policy 9) within the Part 2 Local Plan (adopted October 2019). The site is bound by Green Belt to the north and east.</p> <p>A commitment for 46 dwellings is also allocated to the immediate south of the site on land previously used as a dry ski slope (Housing Commitments: Former Dry Ski Slope) (application ref. 19/00524/OUT)</p>	
<p>Status in SHLAA</p>	<p>N/A</p>	
<p>Planning History</p>	<p>Recent planning history includes:</p> <ul style="list-style-type: none"> • 11/00493/FUL – Full planning application – Change of use of building to martial arts gym – Refused 14.09.11 • 11/00684/FUL – Full planning application – Change of use from warehouse distribution (Class B8) to general industry (Class B2) – Granted 23.12.11 • 15/00778/FUL – Full planning application – Construct 	

	warehouse unit (Class B8) (revised scheme) – Granted 07.01.16	
Current Use and Land Type	Operating as an industrial estate, the site contains relatively modern units, with some divided into smaller workshops/units that are in a good condition, occupied by class E and B2 uses. Business information provided by Broxtowe Borough Council (April 2019) notes the total employment floorspace within the Industrial Estate is 13,402 sqm with 105 people employed across the site.	
Occupier Profile (if partly developed, including % of available land and levels of vacancy onsite)	The occupiers of the site include: Metreel Limited (design, manufacture and install powerfeed, cable and hose handling and personal fall arrest and access systems) Ilkeston Plumbing & Heating Supplies: The Bathroom Showroom Biowood Recycling Birch Ventio Media Credenhill Ltd. (medical supply store) D.E.S. Interiors Ltd. Ghc solutions (central heating and gas boiler service, repair and installation) Response (air conditioning and refrigeration) Direct Pumps & Tanks Ltd. Barnfind Detailing Midland Auto Signs Direct Impressions Design and Print ERF Electrical Wholesalers Mobility Care Apple Furnishing Falcon Premier Furnishings Cabin Master Cosy Home Comforts	
Strategic Road Access	The site adjoins Shilo Way (A6096) off a 4-armed roundabout	Average
Local Road Access	Access from Coronation Road.	Very Good
Proximity to Urban Areas and Access to Labour and Services (including public transport / cycling / walking accessibility)	The site is approximately 2.96 km from Ilkeston town centre accessible from the site by the connecting pedestrian infrastructure including a designated pedestrianised bridge across the railway line. The site is also walkable to Ilkeston train station approximately 0.35km from the site with services to Nottingham, Liverpool Lime Street and Leeds. Immediately opposite the industrial estate, on	Average / Good

	Coronation Road is a single bus stop providing connections to Ikea, Kimberley, Ilkeston and Larklands. Shared cycle infrastructure also begins at the bus stop heading in a westerly direction towards the railway station.	
Compatibility of Adjoining Uses (including amenity impacts experienced by current/future occupiers and neighbouring areas)	The site is bound by the Green Belt to the north and east. Across Coronation Road to the north are allotments and Chatterley House Hotel. To the south of the site is a very steep sided slope previously used as a dry ski slope. The land is now designated for 46 dwellings (Housing Commitments: Former Dry Ski Slope).	Good
Developmental and Environmental Constraints (e.g. size; topography; site access; roads, lighting, landscaping, mains utilities and communications infrastructure; flood risk; contamination; nature and heritage conservation)	<p>The site is rectangular in shape with ingress and egress directly of Coronation Road. The site is an established industrial estate with no obvious development constrains.</p> <p>Much of the site is designated within a Flood Zone 3, with a small area designated within Flood Zone 2 to the west of the site (Flood Map for Planning – Gov.uk, 2020).</p>	Poor
Barriers to Delivery and Mitigation (including ownership constraints - if known)	A key barrier is the risk from flooding given the above designations and any impact of development on the neighbouring Green Belt.	Average
Market Attractiveness (including appropriateness, vacancy and market activity on site for the type of development proposed)	<p>The site is almost in full occupation with just a single unit advertised to let, a 27,889 sq. ft. warehouse/industrial unit marketed with NG Chartered surveyors.</p> <p>The premises comprise of two units interlinked to provide a self-contained unit with integral office and cloakroom accommodation. The building is accessed via a large roller shutter door overlooking a substantial and gated yard providing storage/parking share with the adjoining occupier of unit 2. The asking price of warehouse is £56,250 pa with the commercial agent advertising the property as being located in an 'established estate location' with 'excellent access to Junction 26, M1 motorway'.</p>	Good
Strategic Fit with Growth Area Objectives (by target Market Segment)	<p>The following industrial growth sectors are already located within the site:</p> <ul style="list-style-type: none"> • Creative & Digital • Construction <p>The site is located outside but between the Derby and Nottingham 'Regional Centres' (as identified in</p>	Average

	the D2N2 Vision 2030 document).	
OVERALL SITE RATING	Average	
Recommendation and Potential Future Uses	<p>Protect for employment uses</p> <p>Retain current Local Plan Part 2 Designation as an Employment Site</p> <p>Given the site's longevity as an industrial estate and having high levels of occupation within close proximity to public transport links the site should retain its allocation as an employment site.</p>	
SITE SUMMARY:		
<p>The site is located between the town of Ilkeston and the village of Awsworth and contains a number of class B2 and E premises with several of the units of the industrial estate compartmentalised into small workshops and premises. The site employs 105 individuals, is well connected to public transport infrastructure and has high occupation levels with a single unit advertised to let. The site should therefore retain its existing allocation as an employment site, and it is recommended to protect the site for employment uses.</p>		

Meadowbank Court (Ref: BBC10)



**GROSS SITE AREA:
7.22 ha**

**ESTIMATED NET DEVELOPABLE
AREA:
0 ha**

CRITERIA	COMMENT	RATING
<p>Site Context</p> <ul style="list-style-type: none"> • Location with regards to existing employment areas and other sites • How the site fits into the overall portfolio 	<p>The site is located on the edge of the town of Eastwood, bound by the A610 with wider access to the motorway network. Beyond the A610 to the west is an established retail area in Langley Mill. Langley Mill train station is located approximately 1.4km to the west of the site, providing regular services to Nottingham, Leeds and Liverpool Lime Street.</p> <p>The site borders the Nottingham 26 employment area to the north, which contains employers such as Amazon and Hermes in occupation. Raleigh UK is located to the south of the site along the A610.</p>	
<p>Local Plan Designation</p>	<p>The site is allocated as an 'Existing Employment Site: Meadowbank Court' (Policy 9) within the Part 2 Local Plan (adopted October 2019).</p> <p>To the north of the site is land allocated as an 'Employment Commitment' (Nottingham 26), with playing pitches to the east (Policy 28.1b)</p>	
<p>Status in SHLAA</p>	<p>N/A</p>	
<p>Planning History</p>	<p>Recent planning history includes:</p> <ul style="list-style-type: none"> • 06/00927/FUL – Full planning application – Construct first floor extension and external fire escape staircase – Granted 19.12.06 • 10/00724/FUL – Full planning application – Erect lighting columns and CCTV camera – Granted 10.02.11 • 11/00618/FUL – Full planning application – Construct 	

	<p>extension to existing compressor room – Granted 23.11.11</p> <ul style="list-style-type: none"> • 19/00477/REG3 – Regulation 3 application – Construct 3 industrial units (Class B2) – Granted 07.11.19 	
Current Use and Land Type	<p>A mixed-use site comprising of offices, food producers and small workshop units (within Mushroom Farmcourt). The site contains Class E, B2 and B8 businesses.</p> <p>Business information provided by Broxtowe Borough Council (April 2019) notes the total employment floorspace within Meadow Bank Court is 24,140 sqm with 539 employees working across the wider site.</p>	
Occupier Profile (if partly developed, including % of available land and levels of vacancy onsite)	<p>Occupiers of the site include:</p> <p>HCS Health Care Services Trust Precision Engineering LS Electronics Group H Caswell DTL Damper Tech Ltd. Millcourt Shopfittings Tegometall (shelving and shopfittings) Retail Display Systems Royal Mail Warburtons Greene King MB Industrial Pumps & Compressors Ltd. Sanctuary Home Improvements S. N. Products Limited Racepaint</p>	
Strategic Road Access	<p>The site adjoins the A610 (one-way access from the site) and the A608. Following the A610 to the south-east, the road adjoins the M1 within a 7-minute drive (approximately 7.1km).</p>	Average / Good
Local Road Access	<p>Access to the A60 from Old Derby Road, part passing through a residential area.</p>	Very Good
Proximity to Urban Areas and Access to Labour and Services (including public transport / cycling / walking accessibility)	<p>Across the A610 to the west, an established retail park within Langley Mill provides retail and eatery facilities such as a Lidl, Asda Superstore and McDonalds. Travel between the two areas is only accessible by vehicle. Alternatively, to the east of the site in Eastwood, Morrisons is directly accessible by walking (approximately 10 minutes) from the site.</p> <p>Two bus stops are positioned along the A608 (approximately 4-minute walk from the site). The</p>	Good

	<p>stops provide services to Nottingham, Hucknall, Mansfield, Ripley, Heanor and Derby.</p> <p>The site has good pedestrian infrastructure with connectivity to the surrounding residential area, however there are no cycleways or bike infrastructure servicing the site.</p>	
<p>Compatibility of Adjoining Uses (including amenity impacts experienced by current/future occupiers and neighbouring areas)</p>	<p>To the north, the site borders Nottingham 26 comprising of businesses such as Amazon and Hermes.</p> <p>The site does border a residential area to the east of the site however the dwellings are separated from the site by a vegetated buffer.</p>	Average
<p>Developmental and Environmental Constraints (e.g. size; topography; site access; roads, lighting, landscaping, mains utilities and communications infrastructure; flood risk; contamination; nature and heritage conservation)</p>	<p>The site is configured along an x-axis, containing a mini-roundabout near the centre of the site with egress via a one-way junction onto the A610 and access to Meadowbank Court along Old Derby Road (partly passing a residential area). The road along Meadow Bank Way gradually slopes down towards the Warburtons/Greene King entrances at the north of the site. The site is illuminated by street lighting with shrubbery and grassed areas surrounding the units and planted in the office car park.</p> <p>A review of Flood Maps for Planning (Gov.uk, 2021) shows the site is not located within a Flood Zone but borders a Flood Zone 3 corridor positioned on an east-west trajectory.</p>	Good
<p>Barriers to Delivery and Mitigation (including ownership constraints - if known)</p>	<p>Meadowbank Court is an established site with very few vacancies.</p>	Very Good
<p>Market Attractiveness (including appropriateness, vacancy and market activity on site for the type of development proposed)</p>	<p>The site is fully occupied except for a small workshop unit in Mushroom Farmcourt. The site contains notable employers such as Warburtons, Greene King and the Royal Mail.</p> <p>These businesses benefit from a 'strategically advantageous' location with HGVs able to service nearly 40 million people within a 4-hour drive. This equates to just over 60% of the UK's population (Love Business East Midlands, 2020).</p>	Very Good
<p>Strategic Fit with Growth Area Objectives (by target Market Segment)</p>	<p>The following industrial growth sectors are already located within the site;</p> <ul style="list-style-type: none"> • Food & Drink Manufacturing • Creative & Digital 	Very Good

	<ul style="list-style-type: none"> • Logistics & E-Commerce • Health/Social Care <p>The site is located on the border of the Nottingham 'Regional Centre'.</p>	
OVERALL SITE RATING	Good	
Recommendation and Potential Future Uses	<p>Protect for employment uses</p> <p>Retain current Local Plan Part 2 Designation as an Employment Site</p> <p>The site contains a number of notable national employers such as Warburtons, Greene King and the Royal Mail. These businesses benefit from connectivity to approximately 60% of the UK population. The site should retain its designation as a protected employment site.</p>	
SITE SUMMARY:		
<p>Located in Eastwood, the site directly adjoins the A610 with access to the M1 approximately 7-minutes to the south east. The site is allocated as an employment site within the Local Plan Part (adopted October 2019) and contains the national brands of Warburtons, Greene King and Royal whom have access to approximately 60% of the UK population from this site within 4 hours. In total 539 people work across the site, with Meadowbank Court. As a consequence Meadowbank Court should retain its current protection as an employment site.</p>		

Moorgreen Colliery Site, Engine Lane (Ref: BBC11)



**GROSS SITE AREA:
14.34 ha**

**ESTIMATED NET DEVELOPABLE AREA:
0 ha**

CRITERIA	COMMENT	RATING
<p>Site Context</p> <ul style="list-style-type: none"> • Location with regards to existing employment areas and other sites • How the site fits into the overall portfolio 	<p>The site is located at the north-east edge of Eastwood town, with Colliers Wood Nature Reserve to the south and east.</p> <p>The site is located approximately 4 km to the east of Nottingham 26 and Meadowbank Court; however, direct access along Engine Lane directly towards these sites has restricted height access.</p>	
<p>Local Plan Designation</p>	<p>The site is allocated as an '<i>Existing Employment Sites: Moorgreen Colliery Site, Engline Lane</i>' (Policy 9) within the Part 2 Local Plan (adopted October 2019).</p> <p>The site is bound by the Green Belt (Policy 8) with a Local Wildlife Site to the north (The Dumbles, Policy 31.2a) and Colliers Wood Local Nature Reserves to the south and east (Policy 28.1f).</p>	
<p>Status in SHLAA</p>	<p>N/A</p>	
<p>Planning History</p>	<p>Recent planning history includes:</p> <ul style="list-style-type: none"> • 08/00146/FUL – Full planning application – Demolish existing industrial unit and replace with 9 micro industrial units – Granted 14.05.08 • 09/00131/ROC – Removal of condition No5 (hours of use) of planning permission 08/00146/FUL – Refused 01.05.09 • 10/00695/FUL – Full planning application – construct canopy and link bridge – Granted 18.01.11 • 11/00106/ROC – Removal of condition No5 (opening house) on planning permission 08/00146/FUL – Refused 25.05.11 	

	<ul style="list-style-type: none"> • 12/00275/FUL – Full planning application – Erect spiral fire escape staircase, with new fire door in main elevation at first floor level – Granted 25.06.12 • 15/00864/FUL – Construct 11 light commercial units (Classes B1-B8 with trade counters) – Granted 16.03.16 • 20/00672/FUL – Full planning application – Construct extension and new roof – Pending Decision – 29.09.20 	
Current Use and Land Type	<p>The site comprises of several large industrial units and a series of courts with starter and small units including Beggarlee Park, Harry’s Court, Birch Park, High Hazels Court, Ash Court, Oak House, Elm House, Chestnut House and Sycamore House occupied by Class E, B2 and B8 uses. All premises are in a good/very good condition with Ash Court constructed in 2017, Sycamore House in 2010 and Birch Park in 2006 (NG Chartered Surveyors, 2020).</p> <p>Business information provided by Broxtowe Borough Council (April 2019) notes the total employment floorspace at Engine Lane is 41,465 sqm with 770 employees working within the site.</p>	
Occupier Profile (if partly developed, including % of available land and levels of vacancy onsite)	<p>Occupiers of the site include: The Cut Shack Engineering, Hickling & Squires Group (Commercial Printer), GCL Food Ingredients, Oakfield Brendan Homes, Oakfield Construction, Bio Unit, Black Box Express Courier Services Team, DWLS Ltd. Heavy Lifting & Rigging Management, BW Fire Engineering, Transatlantic Shipping Ltd Gemini Trading (Nottm) Ltd. (wholesale clothing), Aldseds Bakery, Cadmay Roofing Ltd., Caunton Engineering, Line Equipment, TJ Timber, Prosign Print & Display Alpkit/Alpkit Foundation (outdoor leisure ware and equipment) Sonder Bikes, Aero Fabrications (Leading Edge Technology) Aero Fabrications (Assembly Facility), Transrap Packaging Ltd., Identyco Signage and CNC Specialists, Moorgreen Car Repairs, GPC Group, Abstract Signs, RH Services, Paramount Construction Ltd, Leisure Lites Ltd, Hypasol Clean & Protect, First For Extraction (Heating, ventilation and air conditioning manufacturing), Reece Drywall (commercial plastering and dryliner), Sheldrake Labels, Signs, Apparel & Print Monster Screen Prints, Poly-Props, Yatesey Systems Limited.</p>	
Strategic Road Access	The site adjoins the B600 to the east. The M1 junction is c.10.2 km to the south-east.	Very Poor
Local Road Access	The site is accessed from Engine Lane, with access	Very Poor

	from the west through a residential area. A restricted vehicle height of 2m is in force along Engine lane along with speed calming measures (speed humps) within the residential segment.	
Proximity to Urban Areas and Access to Labour and Services (including public transport / cycling / walking accessibility)	<p>The site is located 2.6 km to the east of Eastwood town centre that provides local amenities such as banking, retail and hospitality premises. The town centre also has a Tesco Express and large Morrisons Supermarket.</p> <p>Given the height restrictions on Engine Lane the site is not serviced by public transport. The nearest bus stop is located at the end of the Lane, c.0.8 km from the site providing a single service to Newthorpe Common.</p> <p>The site does not contain any cycle infrastructure but has good pedestrian links around the site and towards the residential area and nature reserve.</p>	Average
Compatibility of Adjoining Uses (including amenity impacts experienced by current/future occupiers and neighbouring areas)	The site is bound by the Green Belt (Policy 8) and neighbours Colliers Wood Nature Reserve to the south and east. The site also borders a residential area to the west.	Average / Poor
Developmental and Environmental Constraints (e.g. size; topography; site access; roads, lighting, landscaping, mains utilities and communications infrastructure; flood risk; contamination; nature and heritage conservation)	<p>The site is irregular in shape and is relatively flat with the exception of the sloping access along Engine Road towards Sycamore House and Chestnut House. As an established site, Moorgreen Colliery is connected to mains utilities and communications infrastructure. Engine Lane itself has street lighting, however Phoneix Road and Engine Road do not benefit from the installation of any street lights.</p> <p>As a previous Colliery, there may be evidence of contamination remaining. The site also adjoins 2 public footpaths with entry to the site from Colliers Wood and exit off Engine Road.</p> <p>A review of Flood Maps for Planning (Gov.uk, 2021) shows the site is not located within a Flood Zone.</p>	Average
Barriers to Delivery and Mitigation (including ownership constraints - if known)	The site is fully developed with no obvious barriers identified from the site visit.	Very Good
Market Attractiveness (including appropriateness, vacancy and	From the site visit, it was noted that 14 of the sub-divided units are vacant within the industrial	Average

<p>market activity on site for the type of development proposed)</p>	<p>courts, with the most vacancies (3) at Chestnut House and (3) at Ash Court, with Elmhouse and Baggarlee Park having 2 units each vacant.</p> <p>Birch Park, High Hazels Court, Sycamore House and Oakhouse have just a single unit each available.</p> <p>Despite the number of vacancies this accounts for an approximatley vacancy rate of <10-15%. Similarly, although there are multiple vacancies only the units at Chestnut House are advertised with a marketing agent to let. Unit 4, advertised by NG Chartered Surveyors, at Chestnut House comprises of 1,040 sq. ft. of space. The unit has a simple lease format with rent paid monthly and qualifies for small business rate relief.</p> <p>The agent describes Moorgreen as a park that accommodates a wide range of locally based companies, Ash Court in particular comprises of 11 starter units. The agent also adds the site has direct access to the M1 with the rent for the unit set at £6,000 pa with no rent review lasting for a term of 3 years.</p> <p>NG Chartered Surveyors also detail that Moorgreen Colliery has received significant investment for the redevelopment of the site, starting with Chestnut House in 1998 and Oak House in 1999. The site contained buildings used as former workshops when the colliery remained open. Their condition was poor and 'letting potential had effectively dried up'.</p>	
<p>Strategic Fit with Growth Area Objectives (by target Market Segment)</p>	<p>The following industrial growth sectors are already located within the site;</p> <ul style="list-style-type: none"> • Food & Drink Manufacturing • Creative & Digital • Logistics & E-Commerce • Construction <p>The site is located to the north of Nottingham's 'Regional Centre' (as identified in the D2N2 Vision 2030 document).</p>	<p>Good</p>
<p>OVERALL SITE RATING</p>	<p>Average</p>	
<p>Recommendation and Potential Future Uses</p>	<p>Protect for employment uses</p> <p>Retain current Local Plan Part 2 Designation as an Existing Employment Site.</p> <p>The site contains a number of businesses that meet the industrial growth sectors targeted by D2N2. The site also contains starter units with local businesses in occupation. The site's designation as an employment site should therefore be safeguarded.</p>	

SITE SUMMARY:

The site is located at the north-east edge of Eastwood town, with Colliers Wood Nature Reserve to the south and east. The site contains a number of large industrial units and a series of industrial courts with units subdivided into smaller workshops/units. Since 1999, Moorgreen Colliery has received significant investment and refurbishment following the Collieries closure. In particular the site has provided starter units which has facilitated the growth of local businesses. Together these businesses contribute to 4 of the industrial growth sectors targeted by D2N2. Of note, the site has 770 employees working across the site. The site should retain its allocation within the Local Plan Part 2 as an employment site.

Phoenix Park (Ref: BBC12)

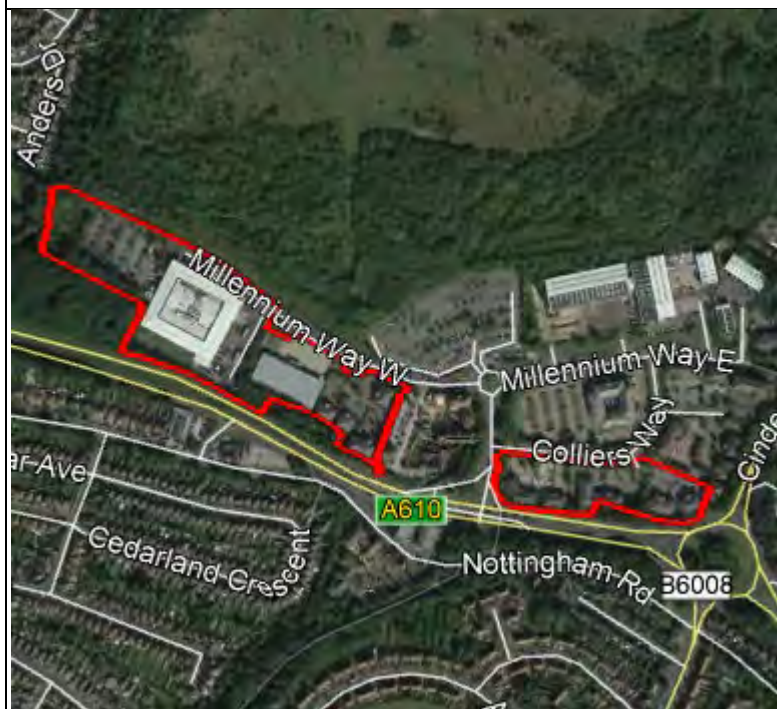

**GROSS SITE AREA:
5.80 ha**

**ESTIMATED NET DEVELOPABLE
AREA:
0 ha**

CRITERIA	COMMENT	RATING
<p>Site Context</p> <ul style="list-style-type: none"> • Location with regards to existing employment areas and other sites • How the site fits into the overall portfolio 	<p>The site is located within the suburbs of north-west Nottingham, with access to the M1 approximately 1.0 km to the west. The site benefits from a Park & Ride to the north of the site with Phoenix Park Tram Stop providing regular services to the City Centre, 7 days a week.</p> <p>Collectively the site forms a major business park, with Stanton Tip to the north and Greasley Street beyond.</p>	
<p>Local Plan Designation</p>	<p>The site is allocated as an '<i>Existing Employment Sites: Phoenix Park</i>' (Policy 9) within the Part 2 Local Plan (adopted October 2019).</p> <p>To the north-west of the site is a Local Wildlife Site (Hempshill Hall, Policy 31.2a) and land designated for 116 dwellings (Housing Commitments: Land East of Low Wood Road Nuthall).</p>	
<p>Status in SHLAA</p>	<p>N/A</p>	
<p>Planning History</p>	<p>Recent planning history includes:</p> <ul style="list-style-type: none"> • 02/00125/FUL – Full planning application – Construct side extension to form 3-car garage and make alterations to parking layout – Granted 28.03.02 • 03/00951/FUL – Full planning application – Construct two storey office units with associated parking – Granted 15.12.03 	

<p>Current Use and Land Type</p>	<p>The site is a modern business park with excellent transport connectivity. The business premises operating on the site consist of Class E and B2 uses. The buildings occupying the site are predominately modern red brick detached office blocks with ancillary parking. Having recently been constructed they are in a very good condition. Two large industrial units are also built on the site; again, these are modern units in a very good condition.</p> <p>Business information provided by Broxtowe Borough Council (April 2019) notes the total employment floorspace within the site is 19,128 sqm with 698 employees working across the park.</p>	
<p>Occupier Profile (if partly developed, including % of available land and levels of vacancy onsite)</p>	<p>Occupiers of the site include:</p> <ul style="list-style-type: none"> SF Recruitment BUPA Health Centre Phoenix Park Nursery Nottinghamshire Appliance Management Service (NHS) Fittleworth (Medical Equipment Leasing and Rental) Multipackaging Solutions British Red Cross Shelby Finance Store Feeder (warehouse management, B2B) NASUWT – The Teachers Union Computer Centre The Guide Dogs for the Blind Association Practice Support Services <p>A single self-contained office is advertised for sale.</p>	
<p>Strategic Road Access</p>	<p>The site adjoins the A610, accessed via a traffic light junction. The A610 connects the site to the M1, approximately 1 km to the west.</p>	<p>Good</p>
<p>Local Road Access</p>	<p>Transit through Colliers Way onto Millennium Way, adjoining a 3-armed roundabout.</p>	<p>Very Good</p>
<p>Proximity to Urban Areas and Access to Labour and Services (including public transport / cycling / walking accessibility)</p>	<p>The site is located within the suburbs of north-west Nottingham, positioned to the north of Cinderhill and west of Bulwell. Both areas contain retail and food premises within walking routes from the site. The site is also accessible via cycling infrastructure forming part of the road network.</p> <p>In particular the site benefits from the Phoenix Park tram stop that provides regular services to the City Centre, seven days a week. The adjoining Park & Ride also has cycle parking and EV charging points. Bulwell train station is located to the north-east of the site, an approximately 15-minute walk. The station provides services to Nottingham, Worksop and Mansfield Woodhouse.</p>	

<p>Compatibility of Adjoining Uses (including amenity impacts experienced by current/future occupiers and neighbouring areas)</p>	<p>The site is constrained by the A610 running along its southern border. To the north-west of the site is a Local Wildlife Site (Hempshill Hall, Policy 31.2a), with the neighbouring designations collectively forming Phoenix Park.</p>	<p>Average</p>
<p>Developmental and Environmental Constraints (e.g. size; topography; site access; roads, lighting, landscaping, mains utilities and communications infrastructure; flood risk; contamination; nature and heritage conservation)</p>	<p>The site forms a patchwork designation with the adjoining employment area forming Phoenix Park. The site is easily accessible from the A610, with a designated lane for turning into the site and a traffic light junction for exit from the park. The site follows a one-way system heading east along Millennium Way and onto Colliers Way.</p> <p>Much of the site is allocated within a Flood Zone 3 designation (Flood Map for Planning – Gov.uk, 2020).</p>	<p>Poor / Average</p>
<p>Barriers to Delivery and Mitigation (including ownership constraints - if known)</p>	<p>An established site with a single unit for sale.</p>	<p>Very Good</p>
<p>Market Attractiveness (including appropriateness, vacancy and market activity on site for the type of development proposed)</p>	<p>A fully let self-contained office building is advertised by marketing agents FHP for sale. 5 Phoenix Place measures 6,093 sq. ft., benefits from 22 car parking spaces and generates £79,500 pa. The buildings advertised sale price is £1,000,000 with a net initial yield of 7.52% and potential reversionary yield of 8.35%.</p> <p>The agent details the site has consistently good levels of occupancy, with Phoenix Business Park ‘one of the primary business parks in Nottinghamshire for both accessibility for private and public transport links’.</p> <p>The current occupational leases are in place at the property;</p> <ul style="list-style-type: none"> • Ground Floor – The Guide Dogs for the Blind Association – Lease 19/07/13-18/07/21 with a rent review on 18/07/21 – Annual Rent equals £36,000 pa. • First Floor – Practice Support Services - Lease 04/05/17-03/05/27 with a rent review on 03/05/22 – Annual Rent equals £43,500 pa. 	<p>Very Good</p>
<p>Strategic Fit with Growth Area Objectives (by target Market Segment)</p>	<p>The following industrial growth sectors are already located within the site;</p>	<p>Very Good</p>

	<ul style="list-style-type: none"> • Health/Social Care • Professional/Business Service <p>The site is located within the Nottingham 'Regional Centre' (as identified in the D2N2 Vision 2030 document).</p>	
OVERALL SITE RATING	Very Good	
Recommendation and Potential Future Uses	<p>Protect for employment uses</p> <p>Retain current Local Plan Part 2 Designation as an Employment Site</p> <p>The site has very high levels of occupation with FHP noting the site has consistently had good levels of occupancy. The site also has excellent transport connectivity by road, rail, cycling and walking and is located within the Nottingham 'Regional Centre'. Consequently, the site should retain its designation as a protected employment site.</p>	
SITE SUMMARY:		
<p>The site is located within the suburbs of north-west Nottingham, positioned to the north of Cinderhill and west of Bulwell. The site is predominantly occupied by modern office complexes with just two large industrial units on site. All are of a modern build and in a very good condition. The site has excellent levels of transport connections with multi-modal choices for commuters including tram, railway or car. Vehicles accessing the business park are only 1km away from the M1. A single office block is advertised for sale with the agents noting the site has consistently good levels of occupation, the site is also located within the Nottingham 'Regional Centre'. A total of 698 employees work within Phoenix Park. The site should retain its designation as an employment site.</p>		

Palmer Drive and Bessell Lane (Ref: BBC13)

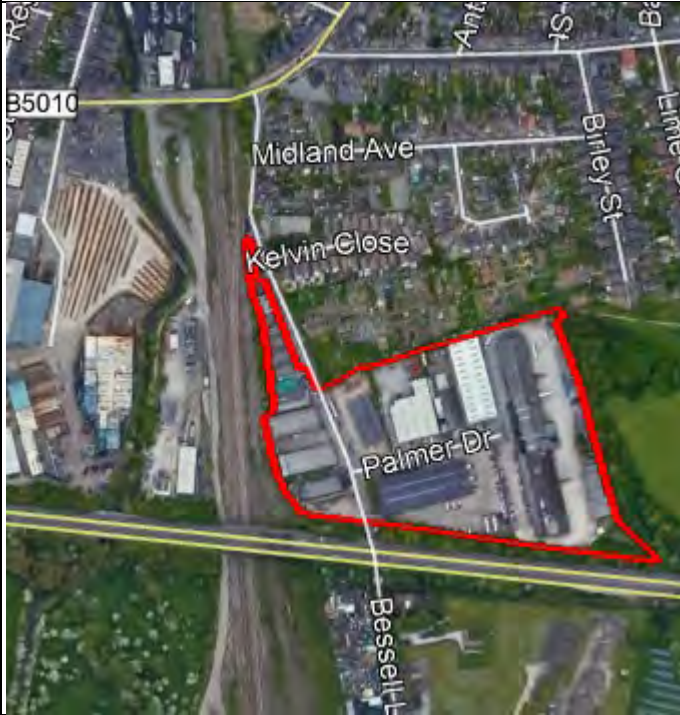

**GROSS SITE AREA:
4.84 ha**

**ESTIMATED NET DEVELOPABLE AREA:
0 ha**

CRITERIA	COMMENT	RATING
<p>Site Context</p> <ul style="list-style-type: none"> • Location with regards to existing employment areas and other sites • How the site fits into the overall portfolio 	<p>The site is located within Stapleford and to the south-east of Sandiacre. To the west, the site borders a railway line with Progress Rail UK, the National Rail Fleet Distribution Centre and Balfour Beatty Rail Plant beyond.</p>	
<p>Local Plan Designation</p>	<p>The site is allocated as an 'Existing Employment Sites: Palmer Drive (including Bessell Lane, north of A52) (Policy 9) within the Part 2 Local Plan (adopted October 2019).</p> <p>The site is bound by HS2 Safeguarding: Safeguarding Limits designation to the west, allotments to the north (Policy 28.1d), archers field recreation ground to the east (Policy 28.1b) and a Mixed-Use Allocation (Toton) to the south (Policy 3.2).</p> <p>The site is also located within the Neighbourhood Plans: Stapleford Area Designation.</p>	
<p>Status in SHLAA</p>	<p>N/A</p>	
<p>Planning History</p>	<p>Recent planning history includes:</p> <ul style="list-style-type: none"> • 07/00981/FUL – Full planning application – Demolish existing building and construct 2 No units for B2 (General Industry) revised scheme – Granted 18.01.08 • 10/00590/FUL – Full planning application – Erection of steel shed for Light industry and/ or storage uses (Class B1/B8) (revised scheme) – Granted 10.12.10 • 14/00194/FUL – Full planning application – Construct industrial unit for (Class B1, B2 and B8) use – Granted 06.06.14 	

	<ul style="list-style-type: none"> • 18/00525/FUL – Full planning application – Construct industrial (Class B1, B2 and B8) unit – Granted 07.02.19 • 20/00648/FUL – Full planning application – Change of use from warehouse (Class B8) to gymnasium (Class E) – Pending decision 	
Current Use and Land Type	<p>A small industrial estate containing Sui Generis, B2 and B8 Uses. The buildings, workshops and smaller units along Bessell Lane are generally in a tired condition. Along Palmer Drive the contrasting and much larger industrial units are more modern and are in a good condition.</p> <p>Business information provided by Broxtowe Borough Council (April 2019) note the total employment floorspace within the site is 13,589.58 m2 with 46 employees working across the site.</p>	
Occupier Profile (if partly developed, including % of available land and levels of vacancy onsite)	<p>Occupiers of the site include:</p> <p>Shepherd Motors Car Dealer & The Car Spa GD Precision Engineering Rapid Online Trading Ltd. Jansway Print Finishers Eagle Scientific Champion Hire UPS Customer Centre DPG Foam Converters Ltd. Auto Reel Kennelpak Pet Food</p>	
Strategic Road Access	<p>Although visible from the A52 to the south, access to the road and the M1 beyond is convoluted requiring a drive of over 1.5 km through residential areas. The site adjoins the B5010 (Derby Road). The B5010 also contains speed calming measures (speed humps) heading east.</p>	Poor
Local Road Access	<p>Accessed via Bessell Lane to the north, bordering a residential area along its eastern trajectory. Bessell Lane is a no exit road, terminating beyond the A52 to the south.</p>	Poor
Proximity to Urban Areas and Access to Labour and Services (including public transport / cycling / walking accessibility)	<p>The site is located within Stapleford and to the south-east of Sandiacre. The adjoining high street along Derby Road contains multiple hospitality venues, convenience stores and retail facilities.</p> <p>The site is not directly serviced by a bus; however, two bus stops are positioned adjacent the junction, along Derby Road, within a short walk to the site. The stops provide services to Sandiacre, Estates, Borrowash, Derby, Long Eaton, Sawley and the East Midlands Airport.</p> <p>The site lacks any cycle infrastructure but is walkable by pavement which connects to the wider</p>	Good

	area. There are also no formal parking facilities at the site.	
Compatibility of Adjoining Uses (including amenity impacts experienced by current/future occupiers and neighbouring areas)	The site is bound by an active railway line to the west, allotments to the north, recreational playing fields to the east and the A52 to the south with a car salvage business, dog kennels and sewerage works beyond.	Good
Developmental and Environmental Constraints (e.g. size; topography; site access; roads, lighting, landscaping, mains utilities and communications infrastructure; flood risk; contamination; nature and heritage conservation)	<p>The site is an irregular shape but is generally level with a very gradual slope rising up Palmer drive towards Kennelpak Pet Food. Communication infrastructure is evident throughout the site, but the area has limited street lights.</p> <p>Access to the site is via a junction onto to Derby Road, speed humps are also located along Derby Road to the east which assists in entry/exit to the site. Along Bessell Lane, the road width is reduced as a result of limited roadside parking restrictions and the consequent cars parked within the road on both sides of the carriageway.</p> <p>Most of the site is also located within a Flood Zone 3 designation, with some strips of Flood Zone 2 along the eastern boundary of the site.</p>	Poor
Barriers to Delivery and Mitigation (including ownership constraints - if known)	The site is fully established with approximately two vacancies (aforementioned flood risk notwithstanding)	Good
Market Attractiveness (including appropriateness, vacancy and market activity on site for the type of development proposed)	<p>Along Bessell Lane an industrial workshop is advertised to let as offices/business units/storage containers. The building is not marketed by an official agent but provides a contact telephone number for enquiries.</p> <p>Towards the end of Bassell Lane a second red bricked industrial unit with adjoining garages appears vacant however no marketing sign is located at the premises. The vacant site measures approximately 0.20 ha.</p> <p>The premises along Bessell Lane are in a tired condition and would benefit from some redevelopment. Formal car parking is relatively sparse within the site with connectivity to the site further confined along Bessell Lane, a no-exit road.</p>	Average
Strategic Fit with Growth Area Objectives (by target Market Segment)	<p>The following industrial growth sectors are already located within the site:</p> <ul style="list-style-type: none"> • Life Sciences 	Good

	<ul style="list-style-type: none"> • Creative & Digital • Logistics & E-Commerce • Construction <p>The site is located to the north of Nottingham's 'Regional Centre' (as identified in the D2N2 Vision 2030 document).</p>	
OVERALL SITE RATING	Average	
Recommendation and Potential Future Uses	<p>Protect for employment uses</p> <p>Retain current Local Plan Part 2 Designation as an Employment Site</p> <p>The established site contains a number of businesses targeted by D2N2 as industrial growth sectors. The site should be retained as an employment site, although the refurbishment of the tired properties along Bessell Lane would greatly improve the site's kerb appeal.</p>	
SITE SUMMARY:		
<p>The site is located within Stapleford and to the south-east of Sandiacre. The site is a small industrial estate comprising of smaller units and workshops along Bessell Lane in a tired condition, contrasting with the more modern and much larger industrial units along Palmer Drive. The site contains a number of businesses that align with the industrial growth sectors targeted by D2N2. The established site should be retained as an employment site with the refurbishment of tired properties along Bessell Lane improving the area's kerb appeal to potential occupiers.</p>		

Main Road, Fernwood Drive, Common Lane and British Bakeries Ltd (Ref: BBC14)



**GROSS SITE AREA:
22.88 ha**

**ESTIMATED NET DEVELOPABLE
AREA:
0 ha**

CRITERIA	COMMENT	RATING
<p>Site Context</p> <ul style="list-style-type: none"> • Location with regards to existing employment areas and other sites • How the site fits into the overall portfolio 	<p>The site is located to the south of Watnall and north of Kimberley within a semi-rural setting. To the east of the site are agricultural fields, the M1 and Blenheim Industrial Estate, with Rolls-Royce beyond to the north-east.</p> <p>Aero Fabrications facility is located between the central gap in the designation (see pro-forma for site BBC18).</p>	
<p>Local Plan Designation</p>	<p>The site is allocated as an 'Existing Employment Sites: Main Road Watnall' (Policy 9) within the Part 2 Local Plan (adopted October 2019).</p> <p>The site is enveloped by the Green Belt (Policy 8) to the north and east with employment commitments (Aero Fabrications) and allocated allotments (Policy 28.1d) located between the Policy 9 designation.</p> <p>The site is also located within the Neighbourhood Plan: Greasley Area designation.</p>	
<p>Status in SHLAA</p>	<p>N/A</p>	
<p>Planning History</p>	<p>Recent planning history includes:</p> <ul style="list-style-type: none"> • 08/00793/FUL – Full planning application – Construct industrial unit (Class B1) – Granted 17.11.08 • 11/00606/FUL – Full planning application – Extend time limit for implementation of planning permission ref: 08/00793/FUL to construct industrial unit (Class 	

	<p>B1) – Granted 17.11.11</p> <ul style="list-style-type: none"> • 12/00098/FUL – Full planning application – Construct covered walkway – Granted 05.04.12 • 20/00165/FUL – Construct industrial units (Class B2) including associated hard surfacing – Granted 21.05.20 	
Current Use and Land Type	A segmented site comprising of medium sized industrial units, a large food production company and offices defined within the E, B2 and B8 use classes . The buildings vary in age and type from a concrete block office, modern red brick office blocks (Field House and MET Office) and metal corrugated roofed industrial units in a good/very good condition.	
Occupier Profile (if partly developed, including % of available land and levels of vacancy onsite)	<p>Occupiers of the site include:</p> <p>Hovis Ltd. (British Bakeries Ltd.) Fernwood Fuel Depot (solid fuel distribution centre) Watnall Hand Car Wash and RBM Services Ltd (car garage) Linby Vans Ltd. Aerofabrications East Midlands Civil Engineering Electract Limited TLC Electrical Distributors Ltd. M&S Interiors (Kitchens & Bedrooms) The Met Office DVLA Test Station Redcliffe Policy Fast (online quote systems) CDW (IT solutions provider) Solos Consultants (recruitment)</p>	
Strategic Road Access	<p>The site adjoins the B600 (Main Road), with residential properties along its western length. The site is approximately 3km (c. 5-minute drive) to the A610/M1 junction.</p>	Poor
Local Road Access	<p>The site adjoins the B600 (Main Road), with residential properties along its western length.</p>	Poor
Proximity to Urban Areas and Access to Labour and Services (including public transport / cycling / walking accessibility)	<p>The site is connected to the wider area via good pedestrian infrastructure. The town of Kimberley is located approximately 1.5 km to the south providing multiple retail and hospitality facilities such as Greggs and a large Sainsbury's Supermarket.</p> <p>Three bus stops directly service the site and are positioned along Main Road with services to Selston, Moorgreen, Phoenix Park, Bestwood, Eastwood, Heanor and Derby.</p>	Good

<p>Compatibility of Adjoining Uses (including amenity impacts experienced by current/future occupiers and neighbouring areas)</p>	<p>The agricultural fields to the north and east form part of the Green Belt. Across Main Road to the east is a substantial residential area, with Aero Fabrications and allotments positioned between the two areas of the site.</p>	<p>Average</p>
<p>Developmental and Environmental Constraints (e.g. size; topography; site access; roads, lighting, landscaping, mains utilities and communications infrastructure; flood risk; contamination; nature and heritage conservation)</p>	<p>Main Road provides direct access to all segments of the site, the employment area is relatively disjointed with the designation marginally separated along Main Road, particularly with the allotments and Aero Fabrication separating the site. There are no parking restrictions along Common Lane, with much of the road becoming relatively narrow as a consequence of parking within the carriageway. Additionally, along Common Lane there is limited street lighting.</p> <p>A review of Flood Maps for Planning (Gov.uk, 2021) shows the site is not located within a Flood Zone.</p>	<p>Good</p>
<p>Barriers to Delivery and Mitigation (including ownership constraints - if known)</p>	<p>Should Fernwood Fuel Depot become vacant some remediation may be necessary, particularly within the coal storage yard of the facility.</p>	<p>Average</p>
<p>Market Attractiveness (including appropriateness, vacancy and market activity on site for the type of development proposed)</p>	<p>The site has no vacancies. Fernwood Property describe Field House as ‘high quality Grade A offices in an attractive semi-rural location with excellent transport links’. The offices are currently fully let.</p>	<p>Very Good</p>
<p>Strategic Fit with Growth Area Objectives (by target Market Segment)</p>	<p>The following industrial growth sectors are already located within the site;</p> <ul style="list-style-type: none"> • Food & Drink Manufacturing • Life Sciences • Construction • Professional/Business Service <p>The site is located on the border of the Nottingham ‘Regional Centre’ (as identified in the D2N2 Vision 2030 document).</p>	<p>Good</p>
<p>OVERALL SITE RATING</p>	<p>Good</p>	
<p>Recommendation and Potential Future Uses</p>	<p>Protect for employment uses</p> <p>Retain current Local Plan Part 2 Designation as an Employment Site</p> <p>The site contains a number of notable employers such as Hovis Ltd., the MET Office, DVLA and Aero Fabrications. The site has very high levels of occupation in an ‘attractive location with excellent transport links’. The activities of the business within the site align with 4 of the industrial growth sectors</p>	

	targeted by D2N2. Consequently, the site should retain its designation as an employment site.
--	---

SITE SUMMARY:

The site is located to the south of Watnall and north of Kimberley within a semi-rural setting. The site directly adjoins the Main Road and contains a number of notable employers such as Hovis Ltd., the Met Office, DVLA and Aero Fabrications. Fernwood Property describe the site as an ‘...attractive location with excellent transport links’. The activities of the business within the site align with 4 of the industrial growth sectors targeted by D2N2. The site should retain its designation as a protected employment site.

Beeston Business Park (Ref: BBC15)



GROSS SITE AREA:
3.89 ha

ESTIMATED NET DEVELOPABLE AREA:
0 ha

CRITERIA	COMMENT	RATING
<p>Site Context</p> <ul style="list-style-type: none"> • Location with regards to existing employment areas and other sites • How the site fits into the overall portfolio 	<p>The site is located within the town of Beeston approximately 5.5km south-west of Nottingham City Centre. To the north-east is the University of Nottingham's main campus and the pharmaceutical and retail chemist group Boots has its headquarters approximately 1km to the east.</p> <p>The site forms part of a modern mixed-use employment area along Technology Drive, with the development of Beeston Business Park and dwellings construction to the south.</p> <p>In total, there are three designated Enterprise Zones across Nottingham, of which Beeston Business Park is one.</p>	
<p>Local Plan Designation</p>	<p>The site is allocated for 'Employment Commitment: Beeston Business Area' with 'Housing Commitment: Beeston Business Area' to the south.</p> <p>The site is bound by designated 'Existing Employment Sites: Beeston Business Park, with additional housing allocations across the railway line to the north (Housing Allocations: Beeston Maltings, 56 dwellings, Policy 3.6).</p>	
<p>Status in SHLAA</p>	<p>Reference: 499 (Beeston Business Park Technology Drive Beeston, for 310 dwellings)</p>	
<p>Planning History</p>	<p>Recent planning history includes:</p> <ul style="list-style-type: none"> • 07/00757/OUT – Outline application for employment development (Classes B1/B2/B8), comprising up to 61,366m² floorspace, including up to 30,723m² B1(a) office, demolition of 47,267m² exiting buildings with 	

	<p>details of access unreserved – Withdrawn 30.11.17</p> <ul style="list-style-type: none"> • 08/00505/OUT – Outline application for employment development (Classes B1/B2/B8), comprising up to 61,366m² floorspace, including up to 30,723m² B1(a) office, demolition of 47,267m² existing buildings with details of access unreserved (revised scheme) – Withdrawn 31.12.10 • 14/00242/FUL – Hybrid planning application comprising: Full application for industrial, storage and distribution buildings (Use Classes B1 b and c, B2 and B8), land for school expansion (Class D1), car parking and associated road infrastructure. Outline application for up to 310 residential units and community building with means of access included (all other matters reserved) - Granted 03.11.17 • 18/00465/FUL – Full planning application – Construct industrial, storage and distribution buildings (use classes B1 (c), B2 and B8) and associated car parking, landscaping and yard areas. Retain gatehouse (revised scheme) – Granted 30.11.18 • 19/00232/FUL – Full planning application – Construct car park ancillary to Waterfront House – Granted 05.08.19 	
Current Use and Land Type	The site is part of the newly constructed Beeston Business Park – known as Trent Gateway, occupied by a length of industrial / warehouse units compartmentalised into smaller units.	
Occupier Profile (if partly developed, including % of available land and levels of vacancy onsite)	<p>The business units are occupied by Indoor Sport Service/Again Faster, Howdens and CEN Automotive. There are 16 units (some sub-divided) within the business park and currently 12 vacant units.</p> <p>Business information provided by Broxtowe Borough Council (April 2019) notes that the total employment floorspace throughout the wider Beeston Business Park is 24,173 sqm (including BBC4 to the south-west) with 162 employees working across the site.</p>	
Strategic Road Access	300m to the south-west of the A6005 from Meadow Road/Station Road	Poor
Local Road Access	<p>Access from Station Road/Meadow Road through residential roads passing a nursery and care home.</p> <p>Technology Drive itself has restricted access controlled via a gated security barrier.</p>	Poor
Proximity to Urban Areas and Access to Labour and Services (including public transport / cycling / walking accessibility)	The site is within walking distance of Beeston Town centre and a short walk from Beeston train station with services to Birmingham New Street, St Pancras International, Matlock, Newark Castle, Lincoln, Cardiff Central, Leicester and Nottingham.	Very Good

	As a newly developed complex the site has good pedestrian infrastructure and a shared cycleway runs along Meadow Road. Technology Drive also benefits from a long stay car park located adjacent the train station.	
Compatibility of Adjoining Uses (including amenity impacts experienced by current/future occupiers and neighbouring areas)	The site is bound by Technology Drive to the north and the railway beyond, Meadow Road to the east, new residential development to the south and established industrial units to the west (now included within the business park) and a lake beyond.	Average
Developmental and Environmental Constraints (e.g. size; topography; site access; roads, lighting, landscaping, mains utilities and communications infrastructure; flood risk; contamination; nature and heritage conservation)	This is a level site with access from Meadow Road via Technology Drive. It comprises of a new business park with all the associated infrastructure and utilities in place. A review of Flood Maps for Planning (Gov.uk, 2021) shows the site is located within a Flood Zone 2.	Average / Good
Barriers to Delivery and Mitigation (including ownership constraints - if known)	The site is fully built-out and benefits from Enterprise Zone status.	Very Good
Market Attractiveness (including appropriateness, vacancy and market activity on site for the type of development proposed)	The vacant units in the Park are advertised by marketing agents FHP. The following units are available to let or sale (having been only recently constructed): <ul style="list-style-type: none"> • Unit 3 (19,305 sq. ft.) • Unit 5 (10,713 sq. ft.) • Unit 11 (13,108 sq. ft.) • Unit 13 (10,488 sq. ft.) • Unit 17 (5,886 sq. ft.) • Unit 19 (5,931 sq. ft.) • Unit 21 (15,719 sq. ft.) • Unit 23 (20,620 sq. ft.) • Unit 27 (2,644 sq. ft.) • Unit 29 (2,647 sq. ft.) • Unit 31 (3,250 sq. ft.) • Unit 33 (4,297 sq. ft.) <p>FHP describes the units as newly constructed with excellent sized front yards and car parking. EV charging points are also available with the site benefiting from a direct train link to Nottingham and London St Pancras.</p>	Good

Strategic Fit with Growth Area Objectives (by target Market Segment)	The site is located on the border of the Nottingham 'Regional Centre' (as identified in the D2N2 Vision 2030 document).	Average
OVERALL SITE RATING	Good	
Recommendation and Potential Future Uses	<p>Protect for employment uses</p> <p>Retain current Local Plan Part 2 Designation as an Employment Site</p> <p>The site has only recently seen speculative construction of a number of industrial units which are currently being marketed, benefits from Enterprise Zone status and forms part of a modern business park benefitting from very good transport connectivity, on the border of the Nottingham 'Regional Centre' with complimentary employment areas in the locality. The site should retain its designation as an employment site.</p>	
SITE SUMMARY:		
<p>The site is located in the town of Beeston and within relatively close proximity to the University of Nottingham's main campus and Boots HQ. The site benefits from excellent transport connectivity, particularly the convenient train station providing services locally and to major stations in the national network. As a modern business park that benefits from Enterprise Zone status; is newly constructed with amenities; bordering the Nottingham 'Regional Centre' designation the site should retain its protected designation as an Employment Site.</p>		

Boots Campus (Ref: BBC16)

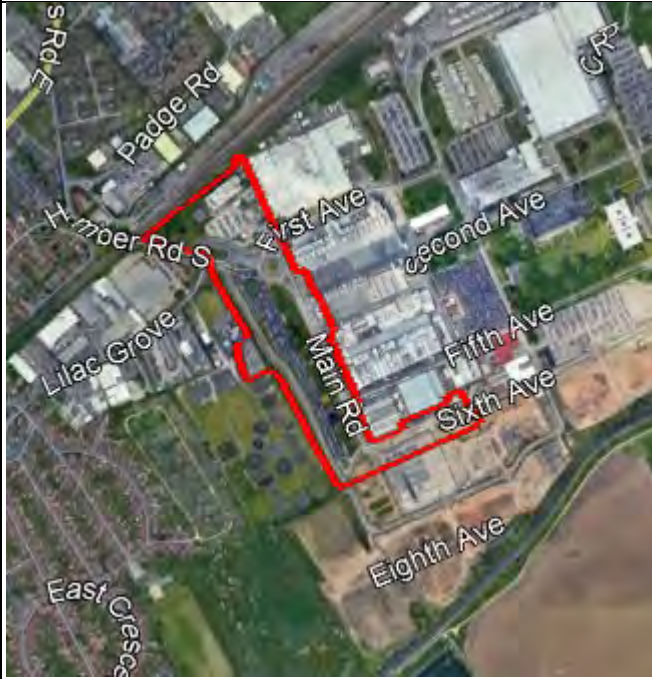

**GROSS SITE AREA:
9.91 ha**

**ESTIMATED NET DEVELOPABLE AREA:
2.52 ha
(development of E1, E2, E3 and E4)**

CRITERIA	COMMENT	RATING
<p>Site Context</p> <ul style="list-style-type: none"> • Location with regards to existing employment areas and other sites • How the site fits into the overall portfolio 	<p>The site is located within the town of Beeston, approximately 6.4km south-west of Nottingham City Centre with the University of Nottingham’s main campus to the north-east.</p> <p>The site forms part of a larger employment area comprising of Evelyn Street and Padge Road to the north, Lilac Grove to the west and Riverside/Lenton Lane industrial area to the east.</p> <p>In total, there are three designated Enterprise Zones across Nottingham, of which the Boots site is one of the three designated zones. The vision for the Boots site is to create a UK centre for innovation in health, beauty and wellness (D2N2).</p>	<p align="center">G</p>
<p>Local Plan Designation</p>	<p>The site is allocated as an ‘Employment Commitments’ within the Part 2 Local Plan (adopted October 2019).</p> <p>To the east of the site, the site is allocated as an ‘Existing Employment Sites: Boots’ (Policy 9) with housing commitments for 400 dwellings along eighth avenue to the south (Reference 237; The Boots Company Beeston Site).</p>	
<p>Status in SHLAA</p>	<p>N/A</p>	
<p>Planning History</p>	<p>Recent planning history includes:</p> <ul style="list-style-type: none"> • 14/00514/FUL – Full planning application – Site and public infrastructure works including new primary vehicle link road and Alliance Boots vehicle access, new canal bridge, associated demolition works, earthworks, 	

	<p>remediation, utilities and drainage infrastructure – Granted 17.12.14</p> <ul style="list-style-type: none"> • 15/00813/ROC – Removal of condition – Variation of condition 2 and removal of condition 15 (to allow for relocation of one gatehouse and demolition of two gatehouses) of planning reference 14/00514/FUL – Granted 29.02.16 • 17/00157/FUL – Full planning application – Construct extension to existing car park – Granted 12.07.17 • 18/00841/FUL – Full planning application – Construct medical technology innovation facility – Granted 26.04.19 • 20/00047/MMA – Minor material amendment application – Minor Material Amendment to planning permission reference 18/00841/FUL (Construct medical technology innovation facility building) to reduce flue height, amend pedestrian access points, install tactile paving at a redundant junction, and insert additional door in the engineering bay.) – Granted 19.03.20
<p>Current Use and Land Type</p>	<p>The site is predominately used as parking for the main Boots HQ site.</p> <p>Business information provided by Broxtowe Borough Council (April 2019) note a total of 1,980 employees work across the wider Boots site.</p>
<p>Occupier Profile (if partly developed, including % of available land and levels of vacancy onsite)</p>	<p>The site is predominately used as parking for the main Boots HQ site. The existing parking and area of green space adjacent to this are proposed to be retained under the wider masterplan for the site (planning application ref. 14/02038/POUT.)</p> <p>The Medical Technologies Innovation Facility (MTIF) (research centre for Nottingham Trent University) and former Boots fire station (Grade II Listed) are located in the northern area of the site. As well as the Boots D98 and D121 buildings, Building D98 was vacant at the time of the site visit (December 2020).</p> <p>Parcels of land within the site are identified for development for employment uses under planning application ref. 14/02038/POUT. These areas include:</p> <ul style="list-style-type: none"> • E1 (2.12 ha) – this area is within the north of the site and includes the MTIF building and former fire station. It was proposed that this would comprise of 10,202 sqm (GFA) of B2 uses with the listed fire station not included. It is understood from discussions with representatives of Boots that there is approximately 1.62 ha of this site remaining for development. <p>The following areas are within the south of the site and currently comprise of car parking and open space:</p> <ul style="list-style-type: none"> • E2 (0.34 ha) - it is proposed that this will comprise 2,211

	<p>sqm (GFA) of use class E office space, ideally with active ground floor uses.</p> <ul style="list-style-type: none"> • E3 (0.29 ha) - it is proposed that this will comprise 1,913 sqm (GFA) of use class E office space, ideally with active ground floor uses. • E4 (0.27 ha) - it is proposed that this will comprise 1,738 sqm (GFA) of office space potentially as a H/Q type offer with possible active use at the ground floor to one or more elevations. 	
Strategic Road Access	Adjoins the A6005 via Humber Road/Beacon Road	Average / Poor
Local Road Access	The site is accessed from a 4-armed roundabout off Humber Road/Lilac Grove to the north east, with both roads travelling through residential areas. Access to the east is via Harrimans Lane.	Average
Proximity to Urban Areas and Access to Labour and Services (including public transport / cycling / walking accessibility)	<p>The site is approximately 2.0km from Beeston Town Centre that contains national retail brands such as a Tesco Extra and Sainsbury's.</p> <p>The site is pedestrianised throughout and connecting to the wider area. The pedestrian infrastructure is also shared with a cycleway on exit from the site. The site is in relatively close proximity to Beeston Railway Station (approximately 1.64km to the west) providing services to Birmingham New Street, St Pancras International, Matlock, Newark Castle, Lincoln, Cardiff Central, Leicester and Nottingham.</p>	Very Good
Compatibility of Adjoining Uses (including amenity impacts experienced by current/future occupiers and neighbouring areas)	The site forms part of the wider Boots HQ site. The site is bound by a railway line to the north.	Very Good
Developmental and Environmental Constraints (e.g. size; topography; site access; roads, lighting, landscaping, mains utilities and communications infrastructure; flood risk; contamination; nature and heritage conservation)	<p>The site comprises of the western portion of the wider Boots site. It has utilities and telecommunications infrastructure in place, there is also an onsite power station which heats and cools the site via a high-pressure steam system.</p> <p>On this site, building D34 the former fire station is Grade II Listed (ref.1247933). Immediately adjacent (to the east), the D6 building (occupied by MediCity) and the D10 Building (occupied by BCM Limited) are both Grade I Listed (ref.1278028, 1247827, respectively). The Boots D90 West Headquarters is also Grade II* Listed (ref.1268303).</p>	Poor

	<p>The Beeston Siding Local Sidings Local Nature Reserve (ref. 1009534) is located immediately north of the railway line.</p> <p>A review of Flood Maps for Planning (Gov.uk, 2021) shows the majority of the site is located within a Flood Zone 3 but is an area benefitting from flood defences.</p>	
<p>Barriers to Delivery and Mitigation (including ownership constraints - if known)</p>	<p>The Boots site benefits from Enterprise Zone status, although the constraints identified above will need to be addressed.</p>	<p>Average</p>
<p>Market Attractiveness (including appropriateness, vacancy and market activity on site for the type of development proposed)</p>	<p>The site is predominately used as parking for the main Boots HQ site and the recently developed Medical Technologies Innovation Facility (MTIF) (research centre for Nottingham Trent University) which is located in the north of the site.</p> <p>The Boots D98 building in the north of the site is currently vacant and parcels of land within the site are identified for redevelopment for employment uses. It is considered that these sites would be attractive to a range of occupiers within the healthcare industry.</p>	<p>Very Good</p>
<p>Strategic Fit with Growth Area Objectives (by target Market Segment)</p>	<p>The following industrial growth sectors are supported by the site:</p> <ul style="list-style-type: none"> • Health/Social Care <p>The site is located on the border of the Nottingham 'Regional Centre' (as identified in the D2N2 Vision 2030 document).</p>	<p>Very Good</p>
<p>OVERALL SITE RATING</p>	<p>Good</p>	
<p>Recommendation and Potential Future Uses</p>	<p>Allocate for employment uses</p> <p>Retain current Local Plan Part 2 Designation as an Existing Employment Commitment</p>	
<p>SITE SUMMARY:</p>		
<p>The site is located on the edge of Beeston, on the border with Nottingham City Council. The site is predominately used as parking for the main Boots HQ and forms part of the wider Boots site which employs a total of 1,980 individuals. The site is allocated as an existing 'Employment Commitments' within the Part 2 Local Plan (adopted October 2019). Given the continued presence of Boots HQ and future proposals for office use on some of the site, it is recommended the site retain its designation as an Employment Commitment.</p>		

Nottingham 26 (Ref: BBC17)



**GROSS SITE AREA:
22.59 ha**

**ESTIMATED NET DEVELOPABLE AREA:
1.51 ha
(application ref. 18/00090/REM)**

CRITERIA	COMMENT	RATING
<p>Site Context</p> <ul style="list-style-type: none"> • Location with regards to existing employment areas and other sites • How the site fits into the overall portfolio 	<p>The site is located in Eastwood, directly adjoining the A610 with wider access to the motorway network. Beyond the A610 to the west is an established retail area located in the village of Langley Mill. Langley Mill train station is situated approximately 1.6km from the site with regular services to Nottingham, Leeds and Liverpool Lime Street.</p> <p>The site borders Meadowbank Court to the south with employers such as Greene King and Warburtons in occupation. Raleigh UK is also located further south of the site along the A610.</p>	
<p>Local Plan Designation</p>	<p>The site is allocated as an 'Employment Commitment: Nottingham 26' within the adopted Part 2 Local Plan (adopted October 2019).</p> <p>Immediately to the north of the site is the Green Belt (Policy 8) with the existing employment site (Meadowbank Court, Policy 9) and Hall Park (playing pitches, 28.1b) to the south.</p>	
<p>Status in SHLAA</p>	<p>N/A</p>	
<p>Planning History</p>	<p>Recent planning history includes:</p> <ul style="list-style-type: none"> • 07/00911/OUT – Outline planning application – Outline application for employment development accommodating Class B2, B8 and B1c uses with a GEA of 71,900 sqm and associated infrastructure including site access and creation of new vehicular access to Mushroom Farm industrial estate (revised 	

	<p>scheme) – Withdrawn 10.07.08</p> <ul style="list-style-type: none"> • 07/00516/OUT – Outline planning application - Outline application for employment development accommodating Class B1, B2 and B8 uses with a GEA of 84,500 sqm and associated infrastructure including site access and creation of new vehicular access to Mushroom Farm industrial estate – Refused 24.09.07 • 11/00503/OUT – Outline planning application - Extend time limit for implementation of planning permission ref: 07/00516/OUT for outline application for employment development accommodating Class B1, B2 and B8 uses with a GEA of 84,500 sqm and associated infrastructure including site access and creation of new vehicular access to Mushroom Farm industrial estate – Granted 22.07.11 • 15/00469/REM – Reserved matters application - Reserved matters approval for the construction of three industrial / warehouse units (Use Class B1c/B2/B8) with ancillary offices, plant, gatehouse, associated infrastructure, including service yards, access, parking, landscaping and associated development – Granted 16.10.15 • 18/00090/REM – Reserved matters application - Reserved matters approval for the erection of one industrial / warehouse unit (Use Class B1c, B2 and B8) with ancillary offices, plant, gatehouse, associated infrastructure including service yards, access, parking, landscaping and associated development – Granted 12.04.18 (yet to be constructed). • 20/00146/FUL – Full planning application – Construct 2 gatehouses – Granted 14.04.20 	
Current Use and Land Type	A newly constructed site containing 3 very large warehouse units for B2 and B8 use .	
Occupier Profile (if partly developed, including % of available land and levels of vacancy onsite)	Occupiers of the site include: Amazon Hermes Food Innovations (manufacturer of home baking products)	
Strategic Road Access	The site directly adjoins the A610 off a 3-armed roundabout. Following the A610 to the south east, the road joins the M1 within an 8-minute drive (approximately 8.4km).	Average / Good
Local Road Access	The site directly adjoins the A610.	Very Good
Proximity to Urban Areas and Access to Labour and Services (including public transport / cycling / walking accessibility)	Across the A610 to the west, an established retail park within Langley Mill provides retail and eatery facilities for workers of the site including a Lidl, Asda Superstore and McDonalds. Travel	Poor

	<p>between the two areas is only accessible by vehicle.</p> <p>A private shuttle bus stop is located at the site (information regarding times/routes is unavailable). Car parking is available on site with the central car park for Amazon workers divided into three zones with a designated pedestrian footway. The site is not accessible by walking or cycling.</p> <p>The train station in Langley Mill is approximately 1.9km to the west of the site (4-minute drive) and has services to Nottingham, Leeds and Liverpool Lime Street.</p>	
<p>Compatibility of Adjoining Uses (including amenity impacts experienced by current/future occupiers and neighbouring areas)</p>	<p>The rolling hills to the immediate north of the site form part of the designated Green Belt. The site is relatively isolated from any immediate residential dwellings; however, Eastwood Hall (Grand Georgian Hotel) is located c.0.29km to the east of the site.</p> <p>The southern boundary of the site adjoins Meadowbank Court occupied by major employers such as Greene King and Warburtons.</p>	Very Good
<p>Developmental and Environmental Constraints (e.g. size; topography; site access; roads, lighting, landscaping, mains utilities and communications infrastructure; flood risk; contamination; nature and heritage conservation)</p>	<p>The site is rectangular in shape with ingress and egress off a 3-armed roundabout from the A610. As a newly established site the development is in a very good condition having fresh and well-kept landscaping. The zoned car park is illuminated by flood lights with a flat and levelled surface. A secured barrier access is located on entry to the Amazon unit.</p> <p>A review of Flood Maps for Planning (Gov.uk, 2021) shows the site is not located within a Flood Zone. However, the site immediately borders a Flood Zone 3, designated in an east-west trajectory along the southern border.</p>	Very Good
<p>Barriers to Delivery and Mitigation (including ownership constraints - if known)</p>	<p>The site is fully developed.</p>	Very Good
<p>Market Attractiveness (including appropriateness, vacancy and market activity on site for the type of development proposed)</p>	<p>Owned by the UK's largest private speculative developer, Panattoni, the park is fully occupied by three high-profile brands/employers - in particular Amazon. The site comprises of 2 large and one very large warehouse units of 551,031 sq ft., 89, 073 sq ft. and 75,402 sq ft.</p> <p>The total footprint covers 715,000 and is</p>	Very Good

	estimated to provide up to 700 jobs for the local economy. The site is identified as being 'strategically advantageous' with HGVs able to service nearly 40 million people within a 4-hour drive. This equates to just over 60% of the UK's population (Love Business East Midlands, 2020).	
Strategic Fit with Growth Area Objectives (by target Market Segment)	<p>The following industrial growth sectors are already located within the site;</p> <ul style="list-style-type: none"> • Food & Drink Manufacturing • Logistics & E-Commerce <p>The site is located on the border of the Nottingham 'Regional Centre' (as identified in the D2N2 Vision 2030 document).</p>	Good
OVERALL SITE RATING	Good	
Recommendation and Potential Future Uses	<p>Allocate for employment uses</p> <p>Retain Current Local Plan Part 2 Designation as an Employment Commitment</p> <p>With high-profile global brands, such as Amazon, in occupation of the site and within a strategic location for connectivity to approximately 60% of the UK population and providing an estimated 700 local jobs, the site should continue to be protected for employment use.</p>	
SITE SUMMARY:		
<p>Located in Eastwood the site directly adjoins the A610 with access to the M1 approximately 8-minutes to the south east. The site is strategically located for the 3 occupiers of the site which include Amazon, Hermes and Food Innovators (class B2 and B8). As a consequence of this logistical strength the site should retain its current protection as an employment site.</p>		

Aero Fabrications (Ref: BBC18)



**GROSS SITE AREA:
3.44 ha**

**ESTIMATED NET DEVELOPABLE AREA:
0.44 ha
(ref. 19/00047/MMA)**

CRITERIA	COMMENT	RATING
<p>Site Context</p> <ul style="list-style-type: none"> • Location with regards to existing employment areas and other sites • How the site fits into the overall portfolio 	<p>The site is located to the south of Watnall and north of Kimberley within a semi-rural setting. To the east of the site are agricultural fields, the M1 and Blenheim Industrial Estate, with Rolls-Royce beyond to the north-east.</p> <p>The site neighbours the MET office and DVLA offices/test centre to the north and Watnall industrial area and Hovis Ltd (British Bakeries Ltd) to the south.</p>	
<p>Local Plan Designation</p>	<p>The site is located within the Green Belt (Policy 8) and is allocated as an '<i>Employment Commitments: Aero Fabrications</i>'.</p> <p>The site also borders Allotments: Main Road Allotments Watnall and an Existing Employment Sites Main Road Watnall (Policy 9).</p>	
<p>Status in SHLAA</p>	<p>N/A</p>	
<p>Planning History</p>	<p>Recent planning history includes:</p> <ul style="list-style-type: none"> • 18/00176/FUL – Hybrid planning application comprising: Full application to construct industrial / office units (Class B1 and B2) including link building, attenuation pond, site access, car park and landscaping (Phase 1). Outline application to construct industrial unit (Class B1 and B2) Phase 2. • 19/00047/MMA – Minor material amendment application – Minor Material Amendment to development previously approved under reference 18/00176/FUL for alterations to site layout • 19/00317/MMA – Minor material amendment 	

	application – Minor Material Amendment to planning ref: 19/00047/MMA to alter the highway access	
Current Use and Land Type	The site comprises of newly constructed units with new surfacing and landscaping for Class E and B2 use .	
Occupier Profile (if partly developed, including % of available land and levels of vacancy onsite)	The site is solely occupied by Aero Fabrications, which specialises in the manufacture of precision fabricated details and assemblies for the aerospace industry. C.0.44ha of land remains to be constructed on as part of Phase II of the development (see application ref. 19/00047/MMA).	
Strategic Road Access	The site adjoins the B600 (Main Road), with residential properties along its western length. The site is approximately 3km (c. 5-minute drive) to the A610/M1 junction.	Poor
Local Road Access	The site adjoins the B600 (Main Road), with residential properties along its western length.	Poor
Proximity to Urban Areas and Access to Labour and Services (including public transport / cycling / walking accessibility)	The site is connected to the wider area via good pedestrian infrastructure. The town of Kimberley is located approximately 1.5 km to the south providing multiple retail and hospitality facilities such as Greggs and a large Sainsburys Supermarket. Three bus stops are directly positioned along Main Road with services to Selston, Moorgreen, Phoenix Park, Bestwood, Eastwood, Heanor and Derby.	Good
Compatibility of Adjoining Uses (including amenity impacts experienced by current/future occupiers and neighbouring areas)	The site forms part of the Green Belt, with the designation continuing to the east and north east. Across Main Road to the west is a substantial residential area, with allotments bordering the site to the north and industrial premises to the south.	Average
Developmental and Environmental Constraints (e.g. size; topography; site access; roads, lighting, landscaping, mains utilities and communications infrastructure; flood risk; contamination; nature and heritage conservation)	Main Road provides direct access to the site, with a separate short junction providing direct ingress and egress to the site. The site is well landscaped containing an ancillary car park with newly planted saplings around the sites border. A review of Flood Maps for Planning (Gov.uk, 2021) shows the site is not located within a Flood Zone.	Very Good
Barriers to Delivery and Mitigation (including ownership constraints - if	The site is fully occupied by Aero Fabrications.	Very Good

known)		
Market Attractiveness (including appropriateness, vacancy and market activity on site for the type of development proposed)	The site is built for the specific operations and business needs of Aero Fabrications. The site borders offices and other industrial premises, which are fully occupied.	Very Good
Strategic Fit with Growth Area Objectives (by target Market Segment)	The following industrial growth sectors are already located within the site: <ul style="list-style-type: none"> • Transport Equipment Manufacturing The site is located on the border of the Nottingham 'Regional Centre' (as identified in the D2N2 Vision 2030 document).	Good
OVERALL SITE RATING	Good	
Recommendation and Potential Future Uses	Allocate for employment uses Retain its current protection as an Employment Site Aero Fabrications is a notable employer who have invested significantly in the development of the site to bolster its business activities. Aero Fabrications are one of a few employers in the region whom specialise in Transport Equipment Manufacturing and given it is a key industrial growth sector targeted by D2N2, the site should be protected for ongoing employment use.	
SITE SUMMARY:		
The site is located to the south of Watnall and north of Kimberly within a semi-rural setting. The site is solely occupied by Aero Fabrications who specialise in the manufacture of fabricated details and assemblies for the aerospace industry. Given the nature of the business with very few employers in the region specialising in Transport Equipment Manufacturing, a key industrial growth sector targeted by D2N2, the site should retain its present protection for employment use.		

Chemring Defence Campus (Ref: EBC1)



**GROSS SITE AREA:
8.93 ha**

**ESTIMATED NET DEVELOPABLE
AREA: 0 ha**

CRITERIA	COMMENT	RATING
<p>Site Context</p> <ul style="list-style-type: none"> • Location with regards to existing employment areas and other sites • How the site fits into the overall portfolio 	<p>The site is within an isolated area with the River Derwent bordering the site along the southern edge and surrounded by agricultural fields on all compass trajectories. A narrow stream enters the site at its centre, dividing the site into 2-part islands.</p> <p>The site is a niche employment use, employing specialist contractors from Derby, Nottingham and even Manchester on occasion. Local labour from Sawley and Draycott are also utilised with the campus employing 130 to 200 staff during times of peak demand.</p>	G
Local Plan Designation	<p>The site is designated within the 'Erewash Polices Map 2014' as part of the Green Belt (Policy 3: Green Belt).</p>	
Status in SHLAA	<p>Reference; 173 (SHLAA, 2019) for 243 dwellings. Site not considered suitable for residential development (SHLAA, 2019).</p>	
Planning History	<p>Recent Planning history includes;</p> <ul style="list-style-type: none"> • ERE0210/0053 – Full planning application – Erection of new single-storey building and associated surrounding blast wall to form new environmental test facility – Refused (08 May 2010). • ERE1210/0002 – Full planning application – Erection of a single-storey office and laboratory surrounded by a 4-metre-high sand filled wall – Approved (24 January 2011). 	
Current Use and Land Type	Class B2/Sui Generis , occupied by Chemring Group PLC	

	<p>the site contains a number of building types with laboratories, packing rooms, office space, testing/explosive area and canteen facilities in which specialist defence and pyrotechnic products are manufactured and tested for predominately the Ministry of Defence (the marines) and police use.</p> <p>The site is a lower tier COMAH (Control of Major Accident Hazards) site with HSE licenced buildings on site.</p>	
<p>Occupier Profile (if partly developed, including % of available land and levels of vacancy onsite)</p>	<p>The defence campus is a fully developed site having no room for expansion within its current borders given the requirement needed for sufficient spacing between buildings for safety measures. The building types include garden sheds (approximately 20-30 used as one-man workshops), 1960s office block, period red brick Mill (built in 1924), multi-compartment concrete cast block buildings with 10-12 rooms in each building, dating from the 1960s-70s, packing and storage units. Crib walling is also positioned on site for blast protection. Some more recent buildings have bomb-proof bunkers.</p> <p>The buildings are in good/average condition and are fully occupied, a single unit is vacant however Chemring Group intend to bring it back into use in parallel with its business plans and growth trajectories. During the visit, the company are in the process of replacing and repairing the roof on its chemical building.</p>	
<p>Strategic Road Access</p>	<p>Accessed from Wilne Road/Sawley Road; many miles from the nearest A road / Motorway</p>	<p>Very Poor</p>
<p>Local Road Access</p>	<p>Wilne Lane is a single-track road to the site with several passing places on route. The lane is particularly narrow, wide enough for 1 vehicle. On exit from the site, HGVs are directed north along Wilne Road towards Draycott.</p>	<p>Very Poor</p>
<p>Proximity to Urban Areas and Access to Labour and Services (including public transport / cycling / walking accessibility)</p>	<p>The nearest villages are Draycott to the north (c. 1.93km) and Sawley to the east (c. 2.1km). Both provide retail and food store facilities, with Long Eaton train station in Sawley/New Sawley providing services to Nottingham, Matlock, Newark Castle, Birmingham New Street, Cardiff Central, Sheffield and St Pancras International. Long Eaton is c. 4.0km from the site, an approximately 8-minute drive.</p> <p>Given its remote location there is no public transport to the site, with the site not serviced by pedestrian or cycle infrastructure.</p>	<p>Very Poor</p>
<p>Compatibility of Adjoining Uses</p>	<p>The site is bound by agricultural land with St Chad's Nature Reserve and St Chad's Church</p>	<p>Very Good</p>

(including amenity impacts experienced by current/future occupiers and neighbouring areas)	located 0.35km to the north. With its isolated location and lack of neighbours, the location of the site is well suited for the needs of the business.	
Developmental and Environmental Constraints (e.g. size; topography; site access; roads, lighting, landscaping, mains utilities and communications infrastructure; flood risk; contamination; nature and heritage conservation)	The site is restricted by the Green Belt designation of surrounding land and high flood risk. Similarly, due to the required safety measures buildings must be built a safe distance apart. Consequently, the site is considered fully developed. Positioned adjacent the River Derwent and having a stream enter the site, the occupiers have stated that the site is at high risk to flooding. The site was recently flooded, washing into its office buildings adjacent the Mill at the centre of its site. A review of Flood Maps for Planning (Gov.uk, 2021) does show the majority of the site is located within Flood Zone 3, with several patches designated in Flood Zone 2. The site does not contain any listed buildings (Historic England Listing Map, 2021).	Very Poor
Barriers to Delivery and Mitigation (including ownership constraints - if known)	The site would benefit from flood defences, particularly with the occupants focused on future business growth	Very Poor
Market Attractiveness (including appropriateness, vacancy and market activity on site for the type of development proposed)	The site is in full occupation, with its occupiers having a comprehensive future plans strategy to double its revenue within the 3-5 years. Given its remote location it is perceived to be in low demand and its use as a defence base is most suitable for the location.	Very Poor
Strategic Fit with Growth Area Objectives (by target Market Segment)	The use of the site is not considered an industrial priority sector targeted by D2N2. The site is positioned outside the 'Regional Centre' of Derby' (as identified in the D2N2 Vision 2030 document).	Very Poor
OVERALL SITE RATING	Poor	
Recommendation and Potential Future Uses	Protect for employment uses (For specialised employment use) Although the site performs poorly in many of the appraisal	

	<p>categories, its remote location is ideal for its niche operations and business requirements and is well suited for Chemring Group's operations. The site provides jobs for local residents and utilises niche skills within the wider Nottinghamshire and Derbyshire area. With the company intending to significantly increase revenue within 3-5 years the site should be protected for these niche employment uses.</p>
--	---

SITE SUMMARY:

The site is used by Chemring Group PLC for the manufacturing and testing of pyrotechnic products used by the Ministry of Defence and the Police. Its remote location is well suited for the activities of the business given its operation requirements and lack of neighbours. The site is located within the Green Belt and is further constrained for development opportunities with high levels of flood risk and the spacing requirements needed between buildings to ensure safety. As a consequence, the site is considered to be fully developed. Chemring Group PLC has gradually shaped and intensified the site for their specific commercial business needs over many years and are intending to double their revenue within 3-5 years. The site should be protected for this specific employment use going forward.

Forbes Close Industrial Estate (Ref: EBC2)



GROSS SITE AREA:
7.74 ha

ESTIMATED NET DEVELOPABLE AREA:
0 ha

CRITERIA	COMMENT	RATING
<p>Site Context</p> <ul style="list-style-type: none"> • Location with regards to existing employment areas and other sites • How the site fits into the overall portfolio 	<p>The site is located to the south of Long Eaton, with Long Eaton train station positioned c. 1.28 km to the west of the site. The site is bound by a railway line along its south-eastern boundary and residential dwellings to the east, both separated by a vegetated barrier.</p> <p>The site is part of a wider employment area with Acton Industrial Estate to the north and Fields Farm Industrial Estate to the north-east. Beyond the Estates borders, a vacant area of industrial tarmacked land south of Fields Farm Industrial estate is currently being advertised for the development of Forbes Park providing new trade counter/industrial/warehouse units between 1,000-6,233 sq ft.</p>	
<p>Local Plan Designation</p>	<p>No planning designations to note. However, to the immediate east of the site is a designated Local Nature Reserve (Saved Policy EV10).</p>	
<p>Status in SHLAA</p>	<p>Reference; 122 (SHLAA, 2019) for 276 dwellings Site not considered suitable for residential development (SHLAA, 2019).</p>	
<p>Planning History</p>	<p>Recent planning history includes:</p> <ul style="list-style-type: none"> • 0112/0005 – Full planning application – Erection of (B8) storage and distribution unit with ancillary office space and associated car parking – Granted (10 February 2012) • 0315/0004 – Full planning application – New vehicular access and gates to service yard – Granted (17 April 2015) 	

	<ul style="list-style-type: none"> 0513/0058 – Full planning application – Change of use from light industrial (B1) to sale of motor vehicles (sui generis) to facilitate the expansion of business currently based at unit 7 – Granted (9 July 2013). 	
Current Use and Land Type	An active industrial estate comprising of Class E, B2 and B8 uses . The buildings are in good condition and are dated post 1990.	
Occupier Profile (if partly developed, including % of available land and levels of vacancy onsite)	<p>The site contains 8 units with approximately 50% of the site occupied by DHL distribution, with the second largest unit by observable footprint a DFS. Other major occupiers include Howdens Joinery Co, Wolseley (Plumbers' Merchants), Censol and a Travis Perkins with associated yard facilities. Along Gainsborough Close are the remaining three units that are subdivided into smaller business premises including Cat Lift Trucks (offices), Denmans Electircal (electrical wholesaler), The Designer Sofa Store, Pulsewear, Sovereign Ltd., Cavendish Porscha Ltd (vehicle repair shop) and City Electrical Factors.</p> <p>A single unit is vacant on Gainsborough Close (DATS Test and Measurement).</p>	
Strategic Road Access	Access from Fields Farm Road, the A6005 is approximately 1.7km to the north (c. 5-minute drive).	Very Poor
Local Road Access	Access from Fields Farm Road, adjoining residential area	Average
Proximity to Urban Areas and Access to Labour and Services (including public transport / cycling / walking accessibility)	<p>The site benefits from a bus stop positioned in front of Howdens, off Fields Farm Road, with services to Wilsthorpe and a second bus stop on the opposite side of the road in front of Long Eaton with buses to Long Eaton.</p> <p>The site has good pedestrian infrastructure with walking connectivity to Acton Road Industrial Estate and Fields Farm Industrial Estate. There are no distinct cycle paths nor is the footway shared with cycleways.</p> <p>The centre of Long Eaton is approximately 1.6km to the north having retail and eatery facilities such KFC, Tesco Extra and Aldi. To the west of the site along Fields Farm Road is Long Eaton Train Station (c. 1.28km) approximately a 4-minute drive. The station provides services to Matlock, Nottingham, Sheffield, Derby, Cardiff Central and St Pancras International.</p>	Average
Compatibility of Adjoining	The site is part of a wider employment area with	Average

<p>Uses (including amenity impacts experienced by current/future occupiers and neighbouring areas)</p>	<p>Acton Industrial Estate to the north and Fields Farm Industrial Estate to the north-east. A residential area borders the site to the west, but the sites are separated by a narrow-vegetated corridor.</p> <p>Forbes Hole Local Nature Reserve is designated immediately to the east of the site.</p>	
<p>Developmental and Environmental Constraints (e.g. size; topography; site access; roads, lighting, landscaping, mains utilities and communications infrastructure; flood risk; contamination; nature and heritage conservation)</p>	<p>The site is roughly triangular in shape and fully developed, with DHL dominating the site. As an established site it benefits from a full range of utilities, street lighting throughout with good roads providing on-street parking.</p> <p>A review of Flood Maps for Planning (Gov.uk, 2021) shows the site is located within Flood Zone 3 but is an area benefiting from flood defences. With the recent addition of a new unit accommodating Censol, no further obvious plots now remain on the site in which new premises could be constructed.</p>	Average
<p>Barriers to Delivery and Mitigation (including ownership constraints - if known)</p>	<p>The site is an established and popular industrial estate that is effectively built out</p>	Very Good
<p>Market Attractiveness (including appropriateness, vacancy and market activity on site for the type of development proposed)</p>	<p>A single subdivided unit appears vacant on Forbes Close Industrial Estate (DATS Test and Measurement); however there is no marketing sign on/near the building.</p> <p>Beyond the nature reserve to the north-east is a vacant area of industrial tarmacked land advertised as Forbes Park with new units for sale or to let for use as trade counters/industrial/warehouse units available from 1,000-6,233 sq ft.</p> <p>In total, 11 brand new units will be constructed in what the agents (NG Chartered Surveyors) describe as an “established industrial area”.</p> <p>Given the high levels of occupancy and the presence of a number of well-known national businesses, this demonstrates that the estate is a popular area in which to trade.</p>	Very Good
<p>Strategic Fit with Growth Area Objectives (by target Market Segment)</p>	<p>The following industrial growth sectors are already located within the site;</p> <ul style="list-style-type: none"> • Logistics & E-Commerce 	Good

	<ul style="list-style-type: none"> • Retail • Professional/Business Service <p>The site is positioned just outside of the Derby and Nottingham 'Regional Centre' (as identified in the D2N2 Vision 2030 document).</p>	
OVERALL SITE RATING	Good	
Recommendation and Potential Future Uses	<p>Protect for employment uses</p> <p>Given the established use of the site and considering its spatial context in regard to the wider employment area comprising of Acton Industrial Estate and Fields Farm Industrial Estate (with the forthcoming Forbes Park) the site should be protected for employment use. The site is also well connected to these areas and has just a single vacancy, with some well-known national companies.</p>	
SITE SUMMARY:		
<p>The site is occupied by Class E, B2 and B8 businesses accommodating a total of 8 units with DHL occupying around 50% of the site with DFS the second largest occupier. Along Gainsborough Close three units are subdivided smaller business premises occupied by a mix of businesses including Denmans Electrical (electrical wholesaler), The Designer Sofa Store, Cavendish Porscha Ltd (vehicle repair shop) and City Electrical Factors. The site is effectively fully developed with just a single subdivided unit vacant. The spatial context of the site is part of a larger employment area comprising of Acton Industrial Estate and Fields Farm Industrial Estate in the local vicinity. As an established and popular industrial estate with very limited vacancies it is recommended to protect the site for employment uses.</p>		

Acton Road Industrial Estate (Ref: EBC3)



**GROSS SITE AREA:
16.19 ha**

**ESTIMATED NET DEVELOPABLE
AREA:
0 ha**

CRITERIA	COMMENT	RATING
<p>Site Context</p> <ul style="list-style-type: none"> • Location with regards to existing employment areas and other sites • How the site fits into the overall portfolio 	<p>The site is located in the south of Long Eaton, with the towns train station positioned c. 1.28 km to the west of the site.</p> <p>The large site is part of a wider employment area with Forbes Close Industrial Estate immediately to the south and Fields Farm Industrial Estate to the west. Neighbouring the Estate to the east is a vacant area of industrial tarmacked land which is currently being advertised for the development of Forbes Park providing new trade counter/industrial/warehouse units between 1,000-6,233 sq ft.</p>	
<p>Local Plan Designation</p>	<p>No planning designations to note. However, across Fields Farm Road to the south-east is a designated Local Nature Reserve (Saved Policy EV10).</p>	
<p>Status in SHLAA</p>	<p>Reference; 290 (SHLAA, 2019) for 550 dwellings. Site is not suitable for residential development (SHLAA, 2019).</p>	
<p>Planning History</p>	<p>Recent planning history includes;</p> <ul style="list-style-type: none"> • 0815/0001 – Certificate of Lawfulness – Lawful development certificate for proposed steel frame metal clad enclosure on new foundations and concrete base – Granted (24 September 2015) • 0911/0052 – Full planning application – Retention of one industrial unit for B1/B2 industrial use (unit 2) – 	

	<p>Granted (22 November 2011)</p> <ul style="list-style-type: none"> • 0911/0026 – Change of Use application – Change of Use of existing industrial units to a children’s sports classes facility with associated café and waiting area – Refused (03 November 2011) • 0815/0032 – Change of Use application – Change of Use from nursery and flat to a thirteen-bedroom shared dwelling (sui generis) and external alterations – Granted (16 November 2015) • 0416/0052 – Full planning application – Single storey extension to existing factory premises – Granted (22 June 2016) 	
Current Use and Land Type	An established industrial estate comprising of Class E, B2 and B8 uses with relatively modern and new units to the west of the site in Long Eaton Trading Estate, whilst units to the east of the site date from the 1960s and are starting to look dated and in need of refurbishment.	
Occupier Profile (if partly developed, including % of available land and levels of vacancy onsite)	<p>Long Eaton Trading Estate is formed of 8 units with two vacant units and the rest occupied by Mens Warehouse UK Ltd Logistics Centre with a unit for a visitor’s reception, returns and goods inwards.</p> <p>The eastern segment of the site contains PF Long Eaton Sofas, Phoenix CNC Engineering, Pneumatic Tools and Compressors, CB Conker Bespoke Furniture, Covercraft Upholstery Ltd., Trelleborg, Chapel Joinery, Red Roof Yard, CBS Engineering and Heat Treatment, Sutton Auto Factors, Crossfit Lacemakers, John Ryan Developments Limited, Long Eaton Timber yard and Long Eaton Frame Makers.</p>	
Strategic Road Access	<p>Accessed from Fields Farm Road, the A6005 is approximately 1.5 km to the north (c. 5-minute drive).</p>	Very Poor
Local Road Access	Access from Fields Farm Road or through a residential area, heading south along Acton Road.	Average
Proximity to Urban Areas and Access to Labour and Services (including public transport / cycling / walking accessibility)	<p>The site benefits from a bus stop positioned in front of Long Eaton Trading Estate, off Fields Farm Road with services to Long Eaton, a second bus stop on the opposite side of the road in front of Howdens with buses to Wilsthorpe.</p> <p>The site has good pedestrian infrastructure with walking connectivity to Forbes Close Industrial Estate and Fields Farm Industrial Estate. There are no designated cycle paths nor is the footway shared with cycleways.</p> <p>The centre of Long Eaton is approximately 1.5 km</p>	Average / Good

	to the north having retail and eatery facilities such as KFC, Tesco Extra and Aldi. To the west of the site along Fields Farm Road is Long Eaton Train Station (c.1.28 km) approximately a 4-minute drive. The station provides services to Matlock, Nottingham, Sheffield, Derby, Cardiff Central and St Pancras International.	
Compatibility of Adjoining Uses (including amenity impacts experienced by current/future occupiers and neighbouring areas)	The site is part of a wider employment area with Forbes Close Industrial Estate to the south and Fields Farm Industrial Estate to the east. A residential area immediately borders the site to the north, directly connected via Acton Road. A local nature reserve is designated to the south-east of the site.	Average
Developmental and Environmental Constraints (e.g. size; topography; site access; roads, lighting, landscaping, mains utilities and communications infrastructure; flood risk; contamination; nature and heritage conservation)	The site broadly square in shape and effectively fully developed. As an established site it benefits from utilities, street lighting throughout with good roads. A review of Flood Maps for Planning (Gov.uk, 2021) shows the site is located within a Flood Zone 3, but is an area benefitting from flood defences.	Average
Barriers to Delivery and Mitigation (including ownership constraints - if known)	The site is an established and popular industrial estate that is effectively built out	Very Good
Market Attractiveness (including appropriateness, vacancy and market activity on site for the type of development proposed)	Unit A (Duresta) within Long Eaton Trading Estate is vacant and marketed by FHP. The size of the unit is advertised as 78,100 sq ft with “cost effective manufacturing or distribution space”. Unit D is advertised as being to let on Long Eaton Trading Estate’s board; however, there is no signage of a marketing agent or details online. A small rundown garage unit at the northern edge of the site boundary appears vacant with cleared vacant tarmacked area adjacent. Again, there is no signage of a marketing agent or details online if they are for let/sale. Despite the above, there are no other vacancies and the site is fully occupied. Beyond the sites border to the east of the estate is a vacant area of industrial tarmacked land advertised as Forbes Park with new units for sale	Good

	<p>or to let for use as trade counters/industrial/warehouse units available from 1,000-6,233 sq ft.</p> <p>In total 11 brand new units will be constructed in what the agents (NG Chartered Surveyors) describe as an “established industrial area”.</p> <p>Given the high levels of occupancy and the presence of a number of well-known national businesses, this demonstrates that the estate is a popular area in which to trade; however, a number of the units are starting to look a little tired and in need of refurbishment and there is very little soft landscaping and vegetation on the estate, which reduces its visual amenity and kerb appeal.</p>	
Strategic Fit with Growth Area Objectives (by target Market Segment)	<p>The following industrial growth sectors are already located within the site;</p> <ul style="list-style-type: none"> • Logistics & E-Commerce • Construction <p>The site is positioned just outside of the Derby and Nottingham ‘Regional Centre’ (as identified in the D2N2 Vision 2030 document).</p>	Average
OVERALL SITE RATING	Good	
Recommendation and Potential Future Uses	<p>Protect for employment uses</p> <p>Given the thriving established use of the site and considering its spatial context in regard to the wider employment area comprising of Forbes Close Industrial Estate and Fields Farm Industrial Estate (with the forthcoming Forbes Park) the site should be protected for employment use. The site is also well connected to these areas having just one confirmed vacancy demonstrating its strong market appeal as a business location. The eastern section has a number of older premises dating from the 1960s which are starting to look dated and the estate in general would benefit from enhancements to its visual amenity with opportunities for planting and landscaping.</p>	
SITE SUMMARY:		
<p>The site is occupied by Class E, B2 and B8 businesses, and is broadly divided into 2 areas; relatively modern new units to the west of the site in Long Eaton Trading Estate and within the east of the site buildings dating from the 1960s in an average condition. The site is fully developed despite a small tarmacked vacant area at the northern edge of the boundary. The spatial context of the site is part of larger employment area comprising of Forbes Close Industrial Estate and Fields Farm Industrial Estate in the local vicinity. As a popular and established industrial estate (the largest in Long Eaton) with very limited vacancies it is recommended to protect the site for employment uses.</p>		

Fields Farm Industrial Estate (Ref: EBC4)



GROSS SITE AREA:
5.27 ha

ESTIMATED NET DEVELOPABLE AREA:
0 ha

CRITERIA	COMMENT	RATING
<p>Site Context</p> <ul style="list-style-type: none"> • Location with regards to existing employment areas and other sites • How the site fits into the overall portfolio 	<p>The site is located in the south of Long Eaton, with the town's train station positioned c. 1.93 km to the west of the site. The site is also bound by a railway line along the length of its eastern border which comprises the confirmed HS2 route.</p> <p>The site is part of a wider employment area with Acton Road Industrial Estate to the west and Forbes Close Industrial Estate to the south-west. Bordering the Estate to the south is a vacant area of industrial tarmacked land which is currently being advertised for the development of Forbes Park providing new trade counter/industrial/warehouse units between 1,000-6,233 sq ft.</p>	
<p>Local Plan Designation</p>	<p>No planning designations to note. However, c. 0.30 km to the south of the site is a designated Local Nature Reserve (Saved Policy EV10).</p>	
<p>Status in SHLAA</p>	<p>Reference; 120 (SHLAA, 2019) for 175 dwellings. Site not considered suitable for residential development (SHLAA, 2019).</p>	
<p>Planning History</p>	<p>Recent planning history includes;</p> <ul style="list-style-type: none"> • 1213/0049 – Full planning application – Erection of modular office building and warehouse/store building (B8 use) – Granted (14 February 2014) • 1217/0020 – Full planning application – Erection of 2no industrial units with mixed use classes B2 (general industrial) & B8 (storage and distribution)- Granted (01 February 2018) 	

	<ul style="list-style-type: none"> 1020/0030 – Change of use application – Change of use from storage to upholstery manufacture – Granted (24 November 2020) 	
Current Use and Land Type	An established industrial estate comprising of B2 and B8 (plus ancillary office) uses with buildings in good condition dating from the 1980s to the north, and from the 1990s/2000s in the south.	
Occupier Profile (if partly developed, including % of available land and levels of vacancy onsite)	T.W.T (Trophy wholesale supplies), LF Intimates, Charnos, Lepel (lingerie and swimwear companies), Pochin (Plumbing & Heating Supplies), Plus Art (Printing), Gill (Marine Clothing), B 1st Scaffolding, CPT (Concrete Preservation Technologies), Rise and Recline Ltd., British and Continental Food Brokers, Actavo, Fix Auto Collision and GB Flint Coachworks Ltd.	
Strategic Road Access	Accessed from Fields Farm Road, the A6005 is approximately 1.6 km to the north (c. 5-minute drive)	Very Poor
Local Road Access	Accessed from Fields Farm Road.	Average
Proximity to Urban Areas and Access to Labour and Services (including public transport / cycling / walking accessibility)	<p>The site benefits from a bus stop positioned near the entry of the site with services towards Wilsthorpe, with a second bus stop on the opposite side of the road with buses to Long Eaton.</p> <p>The site has good pedestrian infrastructure with walking connectivity to Acton Road Industrial Estate and Forbes Close Industrial Estate. There are no distinct cycle paths nor is the footway shared with cycleways.</p> <p>The centre of Long Eaton is approximately 0.6 km to the north having retail and eatery facilities such as KFC, Tesco Extra and Aldi. To the west of the site along Fields Farm Road is Long Eaton Train Station (c. 1.93 km) approximately a 4-minute drive. The station provides services to Matlock, Nottingham, Sheffield, Derby, Cardiff Central and St Pancras International.</p>	Good
Compatibility of Adjoining Uses (including amenity impacts experienced by current/future occupiers and neighbouring areas)	<p>The site is part of a wider employment area with Acton Road Industrial Estate to the west and Forbes Close Industrial Estate to the south-west.</p> <p>The majority of the site faces a residential area, across Fields Farm Road.</p> <p>To the south of the site is a vacant area of industrial tarmacked land advertised for Forbes Park.</p>	Average
Developmental and	The site is an established industrial estate and	Average

<p>Environmental Constraints (e.g. size; topography; site access; roads, lighting, landscaping, mains utilities and communications infrastructure; flood risk; contamination; nature and heritage conservation)</p>	<p>rectangular in shape with ingress and egress in the centre of the Estate. Manor House Road services the units within the estate, running in a north-south trajectory.</p> <p>Beyond Forbes Park to the south, a local nature reserve is designated.</p> <p>A review of Flood Maps for Planning (Gov.uk, 2021) shows the site is located within a Flood Zone 3, but is an area benefiting from flood defences.</p> <p>It is understood that the preferred alignment of HS2 will be along the rail line immediately to the east of the Industrial estate, although this will not require any land take from the estate itself.</p>	
<p>Barriers to Delivery and Mitigation (including ownership constraints - if known)</p>	<p>The site is an established and popular industrial estate that is effectively built out.</p>	<p>Very Good</p>
<p>Market Attractiveness (including appropriateness, vacancy and market activity on site for the type of development proposed)</p>	<p>The site has very high levels of occupancy with only Unit C being marketed by Savills (to let), with an asking price of £75,000 pa for 15,800 sq ft. (15,317 sq ft. warehouse/industrial and 563 sq ft. mezzanine stores). The unit is advertised for B8 Storage and Distribution and B1 Light Industrial in “Long Eaton...an established popular industrial location”.</p> <p>With most premises on the site large in size and located within spacious plots, there is some potential to make adaptations /modest expansion should operational requirements occur.</p>	<p>Very Good</p>
<p>Strategic Fit with Growth Area Objectives (by target Market Segment)</p>	<p>The following industrial growth sectors are already located within the site;</p> <ul style="list-style-type: none"> • Food & Drink Manufacturing • Construction • Retail <p>The site is positioned just outside of the Derby and Nottingham ‘Regional Centre’ (as identified in the D2N2 Vision 2030 document).</p>	<p>Good</p>
<p>OVERALL SITE RATING</p>	<p>Good</p>	
<p>Recommendation and Potential Future Uses</p>	<p>Protect for employment uses</p> <p>The site is an established and popular industrial estate forming part of the wider employment area that comprises of Forbes Close Industrial Estate and Acton Road Industrial Estate. With construction of Forbes Park immediately to the south of the site appearing as an extension to the existing industrial area the site should be protected for ongoing employment use.</p>	

SITE SUMMARY:	
<p>The site is occupied by Class E and B2 uses with the units in a good condition. The site has very high levels of occupation with a single unit of 15,800 sq ft. advertised to let for £75,000 pa. Fields Farm Industrial Estate forms part of the wider employment area containing Forbes Close and Acton Road Industrial Estate. Collectively, the area is perceived as “... an established popular industrial location” with additional units forthcoming as part of Forbes Park. Although the HS2 route is identified immediately to the east of the site, it is understood this would not require any additional land take of the estate itself, although there may be construction issues over the course of the project. Given the site’s spatial context, popularity, contribution to the Long Eaton economy and longevity as an industrial estate it is recommended to protect the site for employment uses.</p>	

West Hallam Storage Depot (Ref: EBC5)



GROSS SITE AREA:
47.49 ha

ESTIMATED NET DEVELOPABLE AREA:
0 ha

CRITERIA	COMMENT	RATING
<p>Site Context</p> <ul style="list-style-type: none"> • Location with regards to existing employment areas and other sites • How the site fits into the overall portfolio 	<p>The site is located 0.6 km to the south of the village of West Hallam, a generally isolated site surrounded by agricultural fields. A disused railway line also runs in an east-west trajectory along the sites northern border.</p>	
<p>Local Plan Designation</p>	<p>The site is designated within the 'Erewash Policies Map 2014' as West Hallam Storage Depot (Local Plan Policy E5).</p> <p>The site is also bound by the Green Belt (Policy 3: Green Belt) and borders a disused railway line which runs across the breadth of the northern border (Local Plan: T5 and R1, disused transport routes and recreational trails)</p> <p>A Scheduled Ancient Monument designation is located to the immediate west of the site (EV9) and a small patched scheduled monument designated on the southern border.</p>	
<p>Status in SHLAA</p>	<p>Reference; 344 (SHLAA, 2019) for 1,000 dwellings. SHLAA notes the site is not suitable.</p>	
<p>Planning History</p>	<p>Recent planning history includes:</p> <ul style="list-style-type: none"> • ERE0509/0033 – Variation of condition – Proposed variation of condition 6 of planning permission SED/361/79 to allow warehouse 2, Building 330 and 350 to be used 24 hours a day, 7 days a week. 	
<p>Current Use and Land Type</p>	<p>This is a brownfield site occupied by the West Hallam Industrial Estate. The site comprises of large areas of open storage land and yard compounds as well as an extensive complex of Romney storage/warehouse buildings of breeze block and curved corrugated sheet construction.</p> <p>There is an area of mature woodland within the eastern portion of the</p>	

	site.	
Occupier Profile (if partly developed, including % of available land and levels of vacancy onsite)	The main occupiers include XPO Logistics, Highways England, Murphy Young Caravan Space, Pentagon Corporate Fleet and Moduleo IVC Group Ltd. There are also communal facilities and a café onsite.	
Strategic Road Access	Adjoins Cat and Fiddle Lane, but many miles from the nearest Motorway junction.	Very Poor
Local Road Access	The site can be accessed from Cat and Fiddle Lane. This is a good free-moving road. The site itself has restricted access controlled by a security office and barrier.	Very Good
Proximity to Urban Areas and Access to Labour and Services (including public transport / cycling / walking accessibility)	West Hallam is located 11.2 km north east of Derby and 16 km west of Nottingham. The nearest bus stops are approximately 500m west of the site on Station Road. Services run half-hourly to hourly to Derby and Mansfield from here. There are designated cycle paths within the site. A public footpath positioned on the northern boundary, connects the site to West Hallam.	Poor
Compatibility of Adjoining Uses (including amenity impacts experienced by current/future occupiers and neighbouring areas)	The site is bound to the north and east by greenfield land in agricultural use, to the south by Stanley Brook and greenfield land in agricultural use beyond and Cat and Fiddle Lane to the west with agricultural land beyond.	Good
Developmental and Environmental Constraints (e.g. size; topography; site access; roads, lighting, landscaping, mains utilities and communications infrastructure; flood risk; contamination; nature and heritage conservation)	This is a large level site with infrastructure and utilities in place due to the existing industrial park. A review of Flood Maps for Planning (Gov.uk, 2021) shows the site is not located within a Flood Zone. However, a designated flood zone 3 runs along the southern border of the site in an east to west trajectory, with a very slight encroachment in the site. The site's long-term use as an ordnance depot may have resulted in ground contamination, which is less of an issue for B8 storage and logistics but may be problematic for future non employment uses without ground remediation. It is also understood that the B8 uses are subject to restrictive conditions that control the hours in which HGVs are able to access it. This will limit the scope to expand current operations, which will be problematic	Poor.

	going forward given new e-commerce requirements for 24-hour deliveries and operations.	
Barriers to Delivery and Mitigation (including ownership constraints - if known)	The site is fully constructed, although there is also a concern that the existing and aging Romney Huts will become increasingly difficult to maintain in time as their conditions deteriorate. Consequently, within the Draft Options for Growth (January 2020), the Council note of weak market attraction for redevelopment of the site for employment use and have aspirations for a new garden village of 1,000 homes on the site.	Poor
Market Attractiveness (including appropriateness, vacancy and market activity on site for the type of development proposed)	There are a range of units available from 500 – 160,000s sqft.	Average
Strategic Fit with Growth Area Objectives (by target Market Segment)	The following industrial growth sectors are already located within the site; <ul style="list-style-type: none"> Logistics and E-Commerce The site is located between the Nottingham and Derby 'Regional Centre' (as identified in the D2N2 Vision 2030 document).	Poor
OVERALL SITE RATING	Poor	
Recommendation and Potential Future Uses	<p>Consider releasing for alternative uses</p> <p>The site is an established logistics and storage area, containing a mix of occupiers such as XPO Logistics, Highways England, Murphy Young Caravan Space, Pentagon Corporate Fleet and Moduleo IVC Group Ltd.</p> <p>However, it scores poorly in many respects and there are concerns over its ability to maintain this role in the longer term as the Romney units become less economically viable and the restrictive operational hours for deliveries no longer align with the requirements of e-commerce and last mile logistics.</p> <p>It is recommended that the Council considers releasing this site for alternative uses, although the potential economic impact of a change of use of this large site should not be under-estimated. The Council would need to consider/help to facilitate occupiers relocating to more suitable and accessible locations elsewhere in the Borough. This will require careful consultation with existing occupiers of the site.</p>	
SITE SUMMARY:		
The site is occupied by a mix of businesses including XPO Logistics, Highways England, Murphy Young Caravan Space, Pentagon Corporate Fleet and Moduleo IVC Group Ltd.		

However, given the poor quality of the site, issues over the long-term viability of the Romney huts, restrictive conditions on hours of operation and access it is recommended that further consideration be given to releasing this site from the employment land portfolio.

Stanton Regeneration (Ref: EBC6)



**GROSS SITE AREA:
27.48 ha**

**ESTIMATED NET DEVELOPABLE AREA:
21.98 ha**

(Note: this is based on an 80% adjustment. However, there is potential for significant uplift should the wider site recently acquired by Verdant Regeneration Ltd. (c. 85 ha) be brought forward for employment uses)

CRITERIA	COMMENT	RATING
<p>Site Context</p> <ul style="list-style-type: none"> • Location with regards to existing employment areas and other sites • How the site fits into the overall portfolio 	<p>The site is located to the south-east of Ilkeston, a relatively isolated site that neighbours Crompton Road Industrial Estate and Quarry Hill Industrial Estate to the north.</p> <p>The site forms part of a wider allocation for the development of a mixed-use neighbourhood and new employment land, should the site be developed and connectivity improved it would form part of the wider employment area comprising of Quarry Hill, Crompton Road and Hallam Fields Industrial Estate.</p>	
<p>Local Plan Designation</p>	<p>The site forms part of a wider allocation, as identified in the 'Erewash Core Strategy' (adopted March 2014) under Policy 20: Stanton Ironworks Regeneration. The allocation is for the development of a sustainable new neighbourhood and is identified as a strategic site. The wider site includes land to the north and south of Lows Lane. The land subject to this appraisal sits within the wider site and is located north of Lows Lane. This area broadly forms the extent of land identified for industrial and business uses in the Stanton Regeneration SPD as shown in the extract below.</p>	

Figure 1 Stanton Regeneration Land Use Masterplan

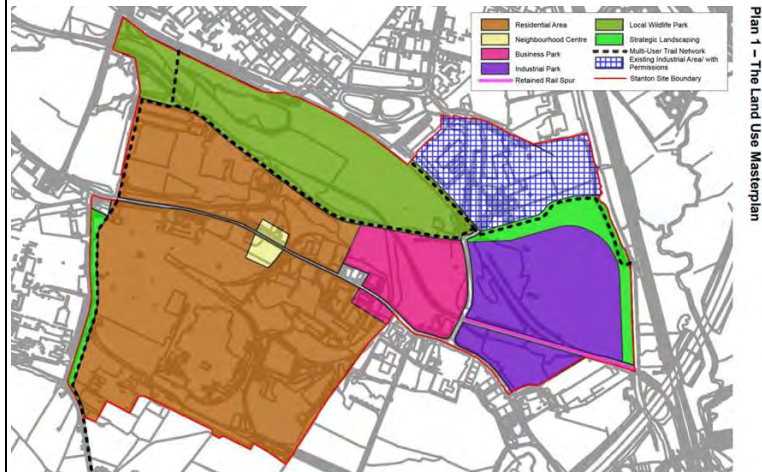

Source: Erewash Borough Council

The high-quality mixed-use neighbourhood will include the provision of 2,000 homes and land for a range of new employment uses (a c.10ha business park; at least 10ha of land for general industry; additional replacement employment land for job losses incurred through the redevelopment where appropriate; and encouraging the utilisation or safeguarding of the rail spur and associated land for rail-freight use).

Other designations include:

- Wild Life Site (site reference: ER 188, Ilkeston Road Pond and Nutbrook Canal) (Policy 17: Biodiversity)
- Wild Life Site (site reference: ER 217, Stanton Ironworks) (Policy 17: Biodiversity)

<p>Status in SHLAA</p>	<p>Reference: 334 (for 2,000 dwellings) Site considered suitable for residential development, achievable, and developable (SHLAA, 2019).</p>
<p>Planning History</p>	<p>Recent planning history includes;</p> <ul style="list-style-type: none"> • 0818/0067 – Full planning application – Erection of new buildings to house concrete precast segments production facility (8,329 sq m), concrete batching plant, staff welfare and office building (795 sq m), open storage, parking for HGVs (38 spaces) and staff (84 spaces) and associated development – Granted (24 August 2018)
<p>Current Use and Land Type</p>	<p>The majority of the site is undeveloped land with some class E and B2 uses on the southern part of the site. The few buildings are of mixed ages and condition such as a modern industrial unit, two derelict buildings (a former training centre and exhibition building) from the 1940s/1950s, seven garages/workshops built in the 1950s and a period red brick building used for offices dated 1914.</p>
<p>Occupier Profile</p>	<p>The land is predominately undeveloped with the few</p>

(if partly developed, including % of available land and levels of vacancy onsite)	occupiers including William West Distribution (lorry yard), Trust Utility Management, PAM Saint Gobain Headoffice and Unbrako Pre-cast concrete.	
Strategic Road Access	<p>The M1 itself curves away from the site to the east but is approximately 4.2 km to the north of a joining junction to the M1. However, transit for HGVs towards Stanton by Dale is currently restricted.</p> <p>Erewash Borough Council Officers have noted there have been repeated local campaigns to establish a 'Junction 25a' which have all been unsuccessful as a result of Highways England advising such a junction would be unlikely to meet the necessary specifications to form a new direct connection to the M1.</p>	Very Poor
Local Road Access	Adjoins Lows Lane to the south with no through access or public connectivity to Crompton Road Industrial Estate and Quarry Hill Industrial Estate to the north/or road infrastructure around the site.	Average
Proximity to Urban Areas and Access to Labour and Services (including public transport / cycling / walking accessibility)	The site is located at the south-east corner of Ilkeston, a relatively isolated site approximately 5.6km from the town centre. There are good paved pedestrian footways along Lows Lane, but as undeveloped land the infrastructure does not continue into the site. There is also no public transport servicing the site or cycle infrastructure at present.	Poor
Compatibility of Adjoining Uses (including amenity impacts experienced by current/future occupiers and neighbouring areas)	<p>To the east of the site is an active railway line with the M1 adjacent. Across Lows Lane to the south is a diverse range of businesses and premises including the Seven Oaks Inn, Close Brothers Vehicle Hire (with vehicle yard, period fire station building and relatively modern unit), Q2 (Quality Used Trucks), Betta Fences, Penna Clothing, DFB Sound & Light warehouse and NPTC UK Ltd, MHM Direct GB and Metron Additive Engineering. Immediately to the west of the site is approximately 4 terrace houses with JP Concrete Products beyond, WFP Fabrications and Midland Caravans.</p> <p>To the north of the site is Nutbrooke Aggregates (currently for sale) with Crompton Road Industrial Estate beyond and Quarry Hill Industrial Estate to the north-east.</p>	Very Good

<p>Developmental and Environmental Constraints (e.g. size; topography; site access; roads, lighting, landscaping, mains utilities and communications infrastructure; flood risk; contamination; nature and heritage conservation)</p>	<p>The site has limited vehicle accessibility with a single private road dividing the land across its central axis. As the majority of the land is undeveloped the site is void of lighting/utility/communications infrastructure. However, past discussions with all the main service providers and utility companies did not identified any fundamental capacity issues in servicing the site (ELS, 2011).</p> <p>The site is also subject to contamination; however, a comprehensive remediation strategy has been prepared in conjunction with the Environment Agency and Environmental Health Officer (ELS, 2011).</p> <p>A disused railway line runs in an east-west trajectory through the site, the line appears to connect to the active railway to the east. With the length of track observed in the centre of the site, the line creates a two-level landscape with a slope from the north onto the railway.</p> <p>A review of Flood Maps for Planning (Gov.uk, 2021) shows the site is not located within a Flood Zone. However, a Flood Zone 2 designation encroaches to the east of the site.</p>	<p>Average</p>
<p>Barriers to Delivery and Mitigation (including ownership constraints - if known)</p>	<p>The site requires remediation, has a lack of infrastructure with sloped topography towards the centre of the site resulting in a two-level landscape.</p> <p>Erewash Borough Council Officers have noted that a significant proportion of the Stanton local plan allocation site (including land assessed within this appraisal) was sold to new owners in December 2020 and amounts to c. 85 hectares of formerly redundant employment space being brought back into a mix of uses. The remainder of the wider Stanton site continues to be earmarked for residential and complementary land-uses. Whilst details of the exact intentions of the owners are not confirmed at present, it is likely that the site will be brought forward for employment uses in accordance with the land use masterplan set out in the SPD.</p>	<p>Good</p>
<p>Market Attractiveness (including appropriateness, vacancy and market activity on site for the type of development proposed)</p>	<p>The site is allocated for the development of a mixed-use neighbourhood with significant employment areas also delivered. At present, the majority of the site is not developed. However, on completion the site has the potential to connect</p>	<p>Average</p>

	<p>with the larger employment area including Crompton Road, Quarry Hill and Hallam Fields Industrial Estate.</p> <p>The site also neighbours Nutbrooke Aggregates to the north. The site is currently for sale, marketed by Savills. The site comprises of 4 plots with plot 4 currently under offer.</p>	
Strategic Fit with Growth Area Objectives (by target Market Segment)	<p>The following industrial growth sectors are already located within the site:</p> <ul style="list-style-type: none"> • Logistics & E-Commerce <p>The site is located outside but between the Derby and Nottingham 'Regional Centre' (as identified in the D2N2 Vision 2030 document).</p>	Average
OVERALL SITE RATING	Average / Poor	
Recommendation and Potential Future Uses	<p>Designate for mixed-use with element of employment uses (i.e. retain current Policy 20: Stanton Ironworks Regeneration)</p> <p>Although there are a number of constraints to the site at present, as a strategic site, Stanton Regeneration should capitalise on the opportunity for employment development in this location.</p> <p>Given the recent acquisition of a significant proportion (c.85 hectares) of the Stanton Local Plan allocation site, it is expected the site will be brought forward for employment uses in accordance with the land use masterplan set out in the SPD. This would include not only the land assessed within this appraisal, but also the wider Stanton site north of Lows Lane amounting to c. 85 hectares, thereby resulting in a potential significant future uplift in available employment space in the Borough.</p>	
SITE SUMMARY:		
<p>The site is a relatively isolated site to the south-east of Ilkeston. The majority of the site is undeveloped with few premises that operate at the edges of the employment boundary. The site is allocated within the 'Erewash Core Strategy' (adopted March 2014) under Policy 20: Stanton Regeneration for the development of a mixed-use neighbourhood with significant employment. Although Stanton Regeneration does not benefit from connectivity to existing infrastructure and is subject to contamination the 2011 ELS details that discussions have taken place with utility companies and they have not identified any capacity issues in servicing the site. Similarly, despite contamination a comprehensive remediation strategy has been composed with the Environment Agency and the Environmental Health Officer. The site should retain its Policy protection as Stanton Ironworks Regeneration, as it is likely that following part of the site's acquisition by Verdant Regeneration Ltd. the land may be brought forward for employment uses in accordance with adopted Planning Policy.</p>		

Progress Rail UK (Ref: EBC7)



**GROSS SITE AREA:
5.44 ha**

**ESTIMATED NET DEVELOPABLE AREA:
0 ha**

CRITERIA	COMMENT	RATING
<p>Site Context</p> <ul style="list-style-type: none"> • Location with regards to existing employment areas and other sites • How the site fits into the overall portfolio 	<p>The site is located within Sandiacre to the south-west of Stapleford. The site borders Great Bear Industrial Estate to the west and the National Rail Fleet Distribution Centre and Balfour Beatty Rail Plant to the east, with a railway line beyond.</p> <p>The neighbouring uses to the east are highly complementary, with the site therefore strategically placed adjacent the railway particularly when considering the lines designation for the safeguarding of HS2.</p> <p>The site has recently seen Progress Rail Services UK Ltd expand their operations across it, leading to securing planning permissions to continue the site's reconfiguration.</p>	
<p>Local Plan Designation</p>	<p>To the north, the site borders the Sandiacre 'Town and Local Centres' designation (Policy 6, 2A).</p> <p>The railway line to the east is designated as a HS2 Safeguarding: Safeguarding Limits allocation (Policy 28.1d, Part 2 Local Plan, Broxtowe, adopted October 2019).</p>	
<p>Status in SHLAA</p>	<p>N/A</p>	
<p>Planning History</p>	<p>Recent planning history includes;</p> <ul style="list-style-type: none"> • 0614/0041 – Full planning application – Proposed single storey extension with glazed link to existing dwelling (revised scheme) – Granted (12 June 2014) 	
<p>Current Use and Land Type</p>	<p>The site operates as a class B2 use, containing industrial units, associated storage yards and parking. Access to the site is controlled by a security barrier along Osmaston Street.</p>	

<p>Occupier Profile (if partly developed, including % of available land and levels of vacancy onsite)</p>	<p>Occupied by Progress Rail UK, the UK's largest manufacturer of niche high-quality rail products and services (Progress Rail UK website, 2020). The site contains industrial units and storage yards.</p> <p>Within the site's boundaries to the west are a strip of units along Bradley Street which are occupied by The Castle Group (tools, tapes and adhesive shop) and Sandiacre Precision Engineering.</p>	
<p>Strategic Road Access</p>	<p>Although visible from the A52 to the south, access to the road and the M1 beyond is convoluted requiring a drive of over 1.5 km through residential areas. The site is within 2.3 km of Sandiacre Interchange (M1/A52 interchange).</p>	<p>Poor</p>
<p>Local Road Access</p>	<p>The site directly adjoins the B5010 which proceeds through residential areas with retail frontages.</p>	<p>Poor</p>
<p>Proximity to Urban Areas and Access to Labour and Services (including public transport / cycling / walking accessibility)</p>	<p>A Lidl supermarket and Burger King drive-thru are located at the top of Mark Street, to the west of the site. The site is serviced by good pedestrian infrastructure on approach with connectivity to Sandiacres local centre (c.1km to the north-west). The site does not benefit from cycle infrastructure, but two bus stops are located along the B5010 with one immediately opposite the site and the other in front of the Lidl Supermarket with services to Nottingham, Ilkeston, Sandiacre, Sawley, Derby and the East Midlands Airport.</p>	<p>Very Good</p>
<p>Compatibility of Adjoining Uses (including amenity impacts experienced by current/future occupiers and neighbouring areas)</p>	<p>The site borders Great Bear Industrial Estate (which contains office facilities for Progress Rail) to the west, with the National Rail Fleet Distribution Centre and Balfour Beatty Rail Plant to the east.</p> <p>The site is positioned directly opposite a residential area with some dwellings on the adjoining high street. Car Scrap Nottingham is also located opposite with AJC Autorepairs positioned on Osmaston Street on approach to the site.</p> <p>The adjoining high street contains a mix of retail premises including restaurants/takeaways, furniture shop, locksmith and a convenience store.</p>	<p>Average</p>
<p>Developmental and Environmental Constraints (e.g. size; topography; site access;</p>	<p>The site is constrained by the National Rail Centre/Balfour Beatty Rail Plant to the east, with the River Erewash enveloping the site running in a</p>	<p>Average</p>

roads, lighting, landscaping, mains utilities and communications infrastructure; flood risk; contamination; nature and heritage conservation)	north-south trajectory. The site is designated within a Flood Zone 2, with some modest parts of the eastern area of the site in Flood Zone 3 along the River Erewash (Flood Maps for Planning – Gov.uk, 2021). The A52 further constrains the site to the south.	
Barriers to Delivery and Mitigation (including ownership constraints - if known)	The site's size provides opportunities for reconfiguration based on Progress Rail's operational requirements. This is highlighted by applications submitted by Progress Rail to develop new facilities which have been approved by EBC. Site is primarily occupied by a single company.	Good
Market Attractiveness (including appropriateness, vacancy and market activity on site for the type of development proposed)	The site is fully occupied for a specialised niche use, the production of rail infrastructure such as points, track and other products. The facility is highly specialised for Progress Rail's requirements, with its nearby connectivity to the main railway line a key commercial requirement.	Average
Strategic Fit with Growth Area Objectives (by target Market Segment)	The following industrial growth sectors are already located within the site; <ul style="list-style-type: none"> • Transport Equipment Manufacturing The site is located outside but between the Derby and Nottingham 'Regional Centres' (as identified in the D2N2 Vision 2030 document).	Good
OVERALL SITE RATING	Good	
Recommendation and Potential Future Uses	Protect for employment uses This large site performs an important local role both in terms of providing good quality local jobs and also maintain the site's past links with the rail industry. The site should be protected for employment use given the bespoke locational requirements and proximity to the HS2 route which could deliver long-term benefits.	
SITE SUMMARY:		
The site is located within the town of Sandiacre and to the south-west of Stapleford. The site is bound by highly complementary uses to the east in respect of the National Rail Fleet Distribution Centre and Balfour Beatty Rail Plant. Great Bear Industrial Estate to the west also contains supportive offices for the site. The site is well serviced by buses with connections to the East Midlands Airport. Given its niche rail manufacturing use in a strategic locality adjoining the proposed HS2 route, the site should be protected for employment use going forward.		

Quarry Hill Industrial Estate (Ref: EBC8)



**GROSS SITE AREA:
22.82 ha**

**ESTIMATED NET DEVELOPABLE
AREA:
0.15 ha**

CRITERIA	COMMENT	RATING
<p>Site Context</p> <ul style="list-style-type: none"> • Location with regards to existing employment areas and other sites • How the site fits into the overall portfolio 	<p>The site is located at the southern edge of Ilkeston, with the town's train station providing services to Nottingham, Leeds and Liverpool Lime Street.</p> <p>The site is part of a wider employment area comprising of Crompton Road Industrial Estate immediately neighbouring the site and Hallam Fields Industrial Estate off to the north-east. The site also borders the Stanton Ironworks Regeneration (Policy 20: Stanton Regeneration Site) to the south with Stanton Bonna Concrete beyond.</p>	
<p>Local Plan Designation</p>	<p>No planning designations to note. However, to the immediate south of the site is Stanton Ironworks Regeneration (Policy 20: Stanton Regeneration Site).</p>	
<p>Status in SHLAA</p>	<p>N/A</p>	
<p>Planning History</p>	<p>Recent planning history includes;</p> <ul style="list-style-type: none"> • 0515/0033 – Full planning application – Proposed warehouse extension – Granted (14 July 2015) • 0918/0056 – Change of use application – Change of use from storage and distribution (Use Class B8) to a mixed Sui Generis use comprising vehicle roadside recovery base and vehicle storage, vehicle repairs and vehicle sales – Granted (07 November 2018) • 0419/0068 – Full planning application – Single storey rear extension and remodelling & extension of the building frontage – Granted (30 July 2019) • 0611/0015 – Full planning application – Erection of B1 (business), B2 (General industrial), B8 (Storage 	

	<p>and distribution) industrial unit) – Granted (03 August 2011)</p> <ul style="list-style-type: none"> • 0518/0053 – Full planning application – Erection of gates and railing to the boundary of 17 Merlin Way – Granted (20 July 2018) • 0818/0072 – Full planning application – Erection of industrial building – Granted (26 October 2018) 	
Current Use and Land Type	A mixed-use industrial estate comprising of use class B2, E and Sui Generis businesses. The buildings of the site date from the 1990s and overall the industrial units occupying the site are in a good condition.	
Occupier Profile (if partly developed, including % of available land and levels of vacancy onsite)	<p>The occupiers of the Estate include:</p> <p>Along Eagle Road; MVS Auto Service and Repair, Creative Wine Making Supply Shop (with amazon distribution), TW Engineering, E.B.S (Euro Business Services), MP Automotive, Ilson fight unit, Midland Access, Trent Baits (Fishing Shop), Dewbar Fabrications, Silk Screeners Limited, DS Garage Services Limited.</p> <p>Along Merlin Way; Vet Medic, UK Powered Access, Regal Furnishing, All tied up (wedding stationary), Sensory Technology, F. H. Bundle (steel stockholder and supplier), Furniture Cloud, Flagpole Express, BK Packaging, Polymer Developments, Donald ward limited (metal & waste recycling). With Heron Court including Mitchell Plastering/ Drylining Ltd., Finch Decking, Ilkeston Ballscrew Services Ltd., Keystep solutions limited, CPM Construction.</p> <p>An overgrown patch of land (c. 0.15 ha) is located on the left on entry to the estate.</p>	
Strategic Road Access	<p>The site is c.400m from the A6096 to the north. Access to the M1 is approximately 5.0 km to the south; however transit for HGVs towards Stanton by Dale is restricted.</p>	Poor
Local Road Access	Access to the site is from Quarry Hill Road avoiding residential areas on both approaches.	Very Good
Proximity to Urban Areas and Access to Labour and Services (including public transport / cycling / walking accessibility)	<p>Located at the southern end of Ilkeston, the town contains retail and eatery facilities including Tesco Express, Morrisons and Asda.</p> <p>The site is connected to the town centre by pedestrian infrastructure that is extended in and around the site. The industrial estate is also serviced by public transport with a bus stop near the site entrance along Quarry Hill Road and a second on the opposite side of the road. The site</p>	Average

	does not benefit from any cycle infrastructure.	
Compatibility of Adjoining Uses (including amenity impacts experienced by current/future occupiers and neighbouring areas)	The site neighbours a residential area to the north, separated by a vegetated buffer. The site is part of a wider employment area with Crompton Road immediately adjacent, Hallam Fields Industrial Estate to the north-east and borders the Stanton Ironworks Regeneration Site to the South (Policy 20) with Stanton Bonna Concrete Plant beyond.	Average
Developmental and Environmental Constraints (e.g. size; topography; site access; roads, lighting, landscaping, mains utilities and communications infrastructure; flood risk; contamination; nature and heritage conservation)	The site is triangular in shape, with access up a slight hill off from Quarry Hill Road. The site is flat and as an established industrial estate benefits from utilities and lighting. A review of Flood Maps for Planning (Gov.uk, 2021) shows the southern area of site is affected by a Flood Zone 2/Flood Zone 3 designation at the south-west corner of the site.	Average
Barriers to Delivery and Mitigation (including ownership constraints - if known)	As the development of the industrial estate in the 1990s replaced works and sidings associated with the adjacent Stanton Ironworks that were cleared during the 1970s, it is likely that there are significant contaminated land issues on the site, although this is less of an issue for the current industrial uses.	Poor
Market Attractiveness (including appropriateness, vacancy and market activity on site for the type of development proposed)	The site overall has a very high level of occupation, with only a single vacancy at Heron Court (Unit 4). The recent planning history of the site is extensive highlighting interest in the site with new units in construction during the site visit. Units 1, 2 and 3 are currently advertised to let at the industrial estate with Innes England. The total space available is 19,869 sq ft. for warehouse and a two-storey office facility. The units have been on the market since the 08 October 2020 and were previously let for B8 use. The agent details that the industrial units are part of a “well established industrial area”. Rent per unit is as follows; <ul style="list-style-type: none"> • Unit 1 - £28,650 pa • Unit 2 - £27,400 pa • Unit3 - £54,950 pa • Units 1 & 2 (combined) - £54,850 pa • Units in entirety - £110,000 pa It is understood that occupancy levels have historically remained very high and the Estate has	Very Good

	a good range of occupiers. It is a popular and well-established industrial location.	
Strategic Fit with Growth Area Objectives (by target Market Segment)	<p>The following industrial growth sectors are already located within the site;</p> <ul style="list-style-type: none"> • Food & Drink Manufacturing • Creative & Digital • Construction • Retail • Professional/Business Service <p>The site is located outside but between the Derby and Nottingham 'Regional Centres' (as identified in the D2N2 Vision 2030 document).</p>	Very Good
OVERALL SITE RATING	Good / Very Good	
Recommendation and Potential Future Uses	<p>Allocate for employment uses</p> <p>The industrial estate is well established, popular, with high occupancy rates, good quality recent development and a diverse mix of businesses. There are high occupancy rates with some opportunity for the development of a small patch of land on entry to the site. The site is part of a wider employment area and has potential to capitalise and extend into the Stanton Regeneration Site to the south. Although there may be historic issues relating to contamination due to its previous use, whilst there is an element of flood risk to the southern part of the site, in general this is an important local employment site that merits protection for employment uses going forward.</p>	
SITE SUMMARY:		
<p>The site is occupied by a mix of business defined within the class E, B2 and Sui Generis use class. Located at the southern edge of Ilkeston the site also benefits from public transport connections and pedestrianised infrastructure within the site accessibility to the wider area. The site has high levels of occupation with scope for extending to the south as part of the Stanton Regeneration. Forming part of a wider employment area the site should be allocated for employment use.</p>		

Crompton Road Industrial Estate (Ref: EBC9)



GROSS SITE AREA:
12.97 ha

ESTIMATED NET DEVELOPABLE AREA:
0 ha

CRITERIA	COMMENT	RATING
<p>Site Context</p> <ul style="list-style-type: none"> • Location with regards to existing employment areas and other sites • How the site fits into the overall portfolio 	<p>The site is located at the southern edge of Ilkeston, with the town's train station providing services to Nottingham, Leeds and Liverpool Lime Street.</p> <p>The site is part of a wider employment area comprising of Quarry Hill Industrial Estate immediately neighbouring the site to the west and Hallam Fields Industrial Estate to the north. To the south of the sites border is the Stanton Ironworks Regeneration designation (Policy 20: Stanton Regeneration Site) with Stanton Bonna Concrete beyond. The site was constructed in the 1980s.</p>	
<p>Local Plan Designation</p>	<p>No planning designation to note. However, to the south of the site is Stanton Ironworks Regeneration (Policy 20: Stanton Regeneration Site).</p>	
<p>Status in SHLAA</p>	<p>Reference: 335 (2,000 dwellings, forming part of the Stanton Regeneration Site)</p> <p>Covers only part of the site to the south, designated across Johnsons Aggregates and Recycling.</p>	
<p>Planning History</p>	<p>Recent planning history includes;</p> <ul style="list-style-type: none"> • 0315/0025 – Full planning application – Extension to an existing building to form covered storage area over existing open storage area – Granted • 1014/0015 – Full planning application – Extension to existing workshop to form workshop and maintenance area – Granted 	
<p>Current Use and Land Type</p>	<p>The site comprises of classes B2, B8, E and Sui Generis uses. The buildings of the site are dated from the 1980s with</p>	

	the industrial units in a good condition and the structures within the waste storage facility considered in an average state.	
Occupier Profile (if partly developed, including % of available land and levels of vacancy onsite)	<p>The majority of the site is occupied by Castle Environmental Waste Storage and Treatment Facility, adjacent Long Eaton Plant Hire Ltd and DPL Self Storage. Johnsons Aggregates and Recycling is positioned to the south of the site.</p> <p>The remainder of the industrial estate comprises of Crompton Road Industrial Units with the largest occupier, St. Johns Packaging. Other businesses include Angus Forklift Truck and Hire, Cornerstone Flooring, Total Precision, Heating & Process Engineering Services Ltd., Heatpr, Canterbury and Dales Fabrications.</p>	
Strategic Road Access	The site is approximately 1.3 km from the Nottingham Road (A609). Access to the M1 is also approximately 6.4 km to the south, however transit for HGVs towards Stanton by Dale is restricted.	Poor
Local Road Access	<p>Access from either Hallam Fields Road (involves travel through residential areas) or Merlin Way (through Quarry Hill Industrial Estate)</p> <p>The site is not accessible to the south.</p>	Average
Proximity to Urban Areas and Access to Labour and Services (including public transport / cycling / walking accessibility)	<p>Located at the southern end of Ilkeston the town contains retail and eatery facilities including Tesco Express, Morrisons and Asda.</p> <p>The site is connected to Quarry Hill Industrial Estate, Hallam Fields Industrial Estate and the wider area via pedestrianised infrastructure. The site does not benefit from cycleways or direct public transport with the closest stops positioned on Quarry Hill Road, near the entrance of Quarry Hill Industrial estate (c. 10-minute walk).</p>	Average
Compatibility of Adjoining Uses (including amenity impacts experienced by current/future occupiers and neighbouring areas)	<p>The site neighbours other industrial areas, to the south-east of the site is Nutbrook Aggregates currently on the market with Plot 4 (0.5 ha) under offer (Savills). Immediately to the south is Stanton Ironworks Regeneration Site (Policy 20).</p> <p>The site also neighbours Ilkeston Rugby Club along its western boundary.</p> <p>Adjoining the site to its north are a number of residential units and the closed St. Bartholomew's Church, of which the corner tower of the structure</p>	Average

	remains Grade II Listed.	
Developmental and Environmental Constraints (e.g. size; topography; site access; roads, lighting, landscaping, mains utilities and communications infrastructure; flood risk; contamination; nature and heritage conservation)	As an established industrial estate, the site is well served by utilities and lighting with few observable constraints. A review of Flood Maps for Planning (Gov.uk, 2021) shows the southern end of Crompton Road is located within a Flood Zone 2.	Average
Barriers to Delivery and Mitigation (including ownership constraints - if known)	Should the Castle Environmental Waste Storage and Treatment Facility or Johnsons Aggregates and Recycling become available remediation may be required. Furthermore, the site's previous use as a railway sidings will have seen contaminants deposited into the ground from rolling stock. While this is less of an issue for the existing industrial uses, this would likely hinder the ease in which the site could be utilised for other development uses.	Poor
Market Attractiveness (including appropriateness, vacancy and market activity on site for the type of development proposed)	The site is in full occupation with established businesses. The site neighbours' other industrial areas that provide complementary industrial uses. To the south-east of the site is Nutbrook Aggregates, currently marketed by Savills. The site comprises of 4 plots with plot 4 currently under offer.	Very Good
Strategic Fit with Growth Area Objectives (by target Market Segment)	The following industrial growth sectors are already located within the site; <ul style="list-style-type: none"> • Construction The site is located outside but between the Derby and Nottingham 'Regional Centres' (as identified in the D2N2 Vision 2030 document).	Average
OVERALL SITE RATING	Good	
Recommendation and Potential Future Uses	<p>Protect for employment uses</p> <p>A popular mixed employment site with a diverse range of conventional units, containing a number of highly specialised premises and open yard areas that have been adapted over the years to meet the occupiers' specific requirements. Occupancy levels are high and the site should be protected for employment uses going forward.</p>	
SITE SUMMARY:		
The site is occupied by a range of B2, B8, E and Sui Generis uses with the largest occupiers of the site including Castle Environmental Waste Storage and Treatment Facility, St. Johns Packaging and Johnsons Aggregates. The site has high levels of occupation with scope for extending to the		

south as part of the Stanton Regeneration. Forming part of a wider employment area the site should be protected for employment use.

Little Eaton Southern Triangle (Ref: EBC10)



**GROSS SITE AREA:
7.64 ha**

**ESTIMATED NET DEVELOPABLE AREA:
0 ha**

CRITERIA	COMMENT	RATING
<p>Site Context</p> <ul style="list-style-type: none"> • Location with regards to existing employment areas and other sites • How the site fits into the overall portfolio 	<p>The site is located to the south of the village of Little Eaton and to the north-west of Breadsall village with a solar farm and the River Derwent (c.1.16km) to the west. Little Eaton Southern Triangle is positioned just off the A38 and A61 interchange.</p> <p>The site accommodates two operations, a Water Treatment Works (WTW) to the north (reflecting the presence of water infrastructure on this site since the late 19th Century with the Derby Water Corporation) and a Garden Centre occupies a narrowing piece of land to the south.</p>	
<p>Local Plan Designation</p>	<p>The site is located within the Green Belt (Policy GB1).</p>	
<p>Status in SHLAA</p>	<p>N/A</p>	
<p>Planning History</p>	<p>Recent planning history includes;</p> <ul style="list-style-type: none"> • 1015/0040 – Installation of Solar Panels – Refused 	
<p>Current Use and Land Type</p>	<p>The site is used as an E class garden centre with farm shop and extensive tarmacked car park, and a Sui Generis water treatment facility.</p>	
<p>Occupier Profile (if partly developed, including % of available land and levels of vacancy onsite)</p>	<p>The site is occupied by two operators including Blue Diamond Garden & Home Derby, a garden centre with farm shop and a water treatment facility. Approximately 25% of the site is used as a tarmacked car park for customers with some storage containers at the end of the car park. As noted</p>	

	above, a Water Treatment Works is active to the north.	
Strategic Road Access	Adjoins the A38 and A61 interchange.	Good
Local Road Access	Alfreton Road (B6179), with transit through residential areas on approach from the north but clear access avoiding residential areas from the south.	Very Good
Proximity to Urban Areas and Access to Labour and Services (including public transport / cycling / walking accessibility)	The site is located 1.2 km to the south of the village of Little Eaton and benefits from pedestrian infrastructure towards Long Eaton with segments of the pathway set back from the carriageway. There is no cycle infrastructure, but two bus stops service the site with services to Belper, Hucknall, Langley Mill, Duffield and Derby.	Average
Compatibility of Adjoining Uses (including amenity impacts experienced by current/future occupiers and neighbouring areas)	The site is bound by the A38 to the east with the A38/A61 interchange to the south, the B6179 to the west and residential dwellings to the north. There is a high degree of mature planting on the boundaries.	Average
Developmental and Environmental Constraints (e.g. size; topography; site access; roads, lighting, landscaping, mains utilities and communications infrastructure; flood risk; contamination; nature and heritage conservation)	The site is triangular in shape and flat throughout, narrowing at the car park's tip. The site is well lit, particularly in the car park however the majority of the site is affected by a Flood Zone 3 designation (Flood Map for Planning – Gov.uk, 2020). The site is also located with the Green Belt, whilst the water treatment works are likely to have ground contamination issues.	Very Poor
Barriers to Delivery and Mitigation (including ownership constraints - if known)	Located within Flood Zone 3 and Green Belt, whilst ground contamination would require a degree of mitigation.	Poor
Market Attractiveness (including appropriateness, vacancy and market activity on site for the type of development proposed)	The site contains two key occupants with the availability of the car park to be used for a redevelopment/expansion opportunity. However, any application would be subject to the conditions and policy tests of the Green Belt designation, whilst employment uses may not be compatible with the garden centre. Furthermore, the Water Treatment Works is a bespoke infrastructure facility and would not be suited to conversion to alternative uses.	Very Poor
Strategic Fit with Growth Area Objectives (by target Market Segment)	The following industrial growth sectors are already located within the site; <ul style="list-style-type: none"> • Retail The site is located on the outskirts of the Derby 'Regional Centre' designation (as identified in the	Very Poor

	D2N2 Vision 2030 document).	
OVERALL SITE RATING	Poor	
Recommendation and Potential Future Uses	<p>Do not allocate Occupied by the Blue Diamond Garden Centre and a water treatment facility with the A38/A61 interchange adjacent. The Water Treatment Works is a bespoke infrastructure facility that could not be easily converted. It is an important part of the local utilities infrastructure, whilst the Garden Centre provides local employment. Neither are traditional industrial/commercial employment uses and the site should not be allocated for B2/B8/office use.</p>	
SITE SUMMARY:		
<p>The site is occupied by two main facilities, a water treatment works and Blue Diamond Garden & Home Derby, a garden centre with farm shop. The successful garden centre has an expansive car park for customers of the garden centre; however, the site is located within the Green Belt that would restrict development on the site. The site should not be allocated for employment use.</p>		

Hallam Fields Industrial Estate (Ref: EBC11)

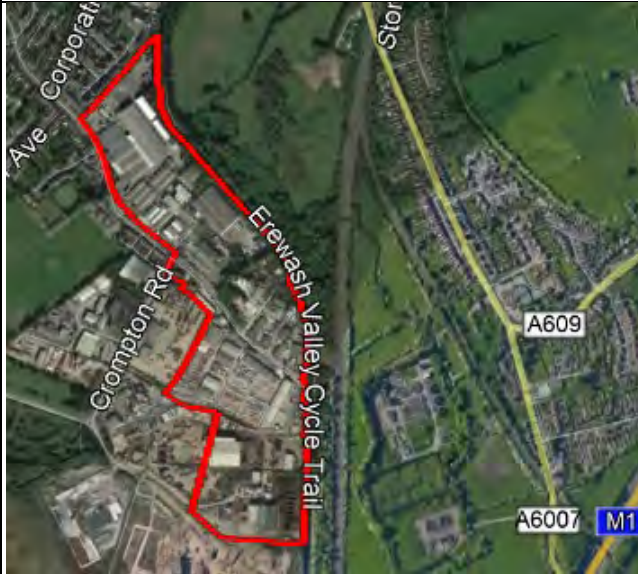

GROSS SITE AREA:
19.57 ha

ESTIMATED NET DEVELOPABLE AREA:
0 ha

CRITERIA	COMMENT	RATING
<p>Site Context</p> <ul style="list-style-type: none"> • Location with regards to existing employment areas and other sites • How the site fits into the overall portfolio 	<p>The site is located at the southern edge of Ilkeston, with the town's train station providing services to Nottingham, Leeds and Liverpool Lime Street.</p> <p>The site is an extension from Crompton Road Industrial Estate (immediately neighbouring to the south) and Quarry Hill Industrial Estate (to the south-west), forming part of the wider employment area. Beyond Crompton Road to the south is the Stanton Ironworks Regeneration designation (Policy 20: Stanton Regeneration Site).</p>	
<p>Local Plan Designation</p>	<p>The site adjoins the Green Belt (Policy GB1) along its eastern border and to the immediate south of the site is Stanton Ironworks Regeneration (Policy 20: Stanton Regeneration Site).</p>	
<p>Status in SHLAA</p>	<p>Reference: 234 (150 dwellings on industrial premises in the northern area of Hallam Fields Industrial Estate).</p> <p>The designation covers part of the site.</p>	
<p>Planning History</p>	<p>Recent planning history includes;</p> <ul style="list-style-type: none"> • 0715/0026 – Change of use from B1/B2 to D2 (Gymnastics Facilities) – Granted • 0614/0018 – Demolition of existing detached canteen block & portacabins on roof – Granted 	
<p>Current Use and Land Type</p>	<p>A mixed-use industrial estate comprising of class B2, B8, E, D2 and Sui Generis uses. The buildings are of a mixed age including a former Grade II listed church built in 1895, new modern industrial units and office premises aging from the 1970s to 2000s.</p>	
<p>Occupier Profile</p>	<p>Occupiers of the site include:</p>	

(if partly developed, including % of available land and levels of vacancy onsite)	<p>EMH Care & Support / EMH Homes (Part of EMH Group), Erewash Valley Gymnastics Club (new built), Konnext Interlogics (Freight Forward Services), Allsopp Bookbinders, The Bespoke Album Co., Breedon Ilkeston Concrete & Ready (Mixed Concrete Plant), Heanor Haulage Ltd.</p> <p>Intersped Logistics (UK Limited), Proc Contractors Ltd., Ilkeston Fencing Ltd., Wilsons Deliveries, Whytemount Civils Ltd., Ward Recycling and Stanton Recycling</p> <p>A single unit is advertised to let.</p>	
Strategic Road Access	The site is approximately 2.0 km from the A6096. Access to the M1 is also approximately 11 km to the north.	Poor
Local Road Access	The site is accessible from Crompton Road to the south (with travel through both Crompton Road and Quarry Hill Industrial Estate) or Longfield Lane/Corporation Road to the east (involves transit through residential areas)	Average
Proximity to Urban Areas and Access to Labour and Services (including public transport / cycling / walking accessibility)	<p>Located at the southern end of Ilkeston the town contains retail and eatery facilities including Tesco Express, Morrisons and Asda.</p> <p>The site is connected to Crompton Road Industrial Estate, Quarry Hill Industrial Estate and the wider area by pedestrian infrastructure. Two bus stops are positioned adjacent the site on Corporation Road, with services to Nottingham and Heanor. The site does not benefit from any cycle infrastructure.</p> <p>A public footpath and the Erewash Valley Cycle Track envelope the site along the northern boundary, with travel to the Little Eaton Southern Triangle and further north to Ilkeston.</p> <p>Beyond the cycle track to the east is a railway line.</p>	Average
Compatibility of Adjoining Uses (including amenity impacts experienced by current/future occupiers and neighbouring areas)	The site is an extension of Crompton Road and Quarry Hill Industrial Estates. However, the site borders a residential area to the west and a row of residential properties to the south west.	Average
Developmental and Environmental Constraints (e.g. size; topography; site access; roads, lighting, landscaping, mains utilities and communications)	Broadly an 'L' in shape the site is constrained along its eastern border by the Green Belt and the neighbouring industrial estate. Hallam Fields Road itself terminates at the east of the site, with	Average / Poor

<p>infrastructure; flood risk; contamination; nature and heritage conservation)</p>	<p>entry for pedestrian and cycles onto the Erewash Valley Cycle Trail.</p> <p>Site adjoins designated local wildlife site (ER215: Erewash Canal), is close to three Listed Buildings including the Grade II listed Church (now closed) which is within the site's boundary), likely contaminated ground and neighbouring residential areas.</p> <p>A review of Flood Maps for Planning (Gov.uk, 2021) shows the southern area of the site is located within Flood Zone 2.</p>	
<p>Barriers to Delivery and Mitigation (including ownership constraints - if known)</p>	<p>The site's previous use as part of Stanton Ironworks castings facility and rail sidings would have seen rolling stock regularly enter the site, will have seen contaminants deposited into the ground. While this is less of an issue for the existing industrial uses, this would likely hinder the ease in which the site could be utilised for other development uses.</p>	<p>Poor</p>
<p>Market Attractiveness (including appropriateness, vacancy and market activity on site for the type of development proposed)</p>	<p>The site is well occupied with approximately 2 units vacant on the site; Warehouse & Offices (310.11 sq ft.) with secure yard (in excess of 5,490 sq ft.) advertised with Heb Chartered Surveyors; and 8 offices to let (£2,100 pa for a single room) with shared reception and car parking on the market with Richard Savidge Chartered Surveyors.</p> <p>Poor environment at east/south-east end of the site.</p> <p>The recent planning history of the indicates a slight departure from traditional industrial uses of the site with the development of the gymnastics club.</p>	<p>Good</p>
<p>Strategic Fit with Growth Area Objectives (by target Market Segment)</p>	<p>The following industrial growth sectors are already located within the site;</p> <ul style="list-style-type: none"> • Creative & Digital • Logistics & E-Commerce • Construction <p>The site is located outside but between the Derby and Nottingham 'Regional Centres' (as identified in the D2N2 Vision 2030 document).</p>	<p>Good</p>
<p>OVERALL SITE RATING</p>	<p>Good</p>	
<p>Recommendation and Potential Future Uses</p>	<p>Protect for employment uses A popular employment site with a diverse range of large units, and open yard areas that could be intensified if required. Occupancy levels are high and the site should be</p>	

	protected for employment uses going forward.
--	--

SITE SUMMARY:

The site is occupied by a mix of class B2, B8, D2, E and Sui Generis Uses. The site is an extension of the neighbouring industrial estates (Crompton Road and Quarry Hill) with high levels of occupation. Forming part of the wider employment area the site should be protected for employment use.

Furnace Road Industrial Estate (Ref: EBC12)

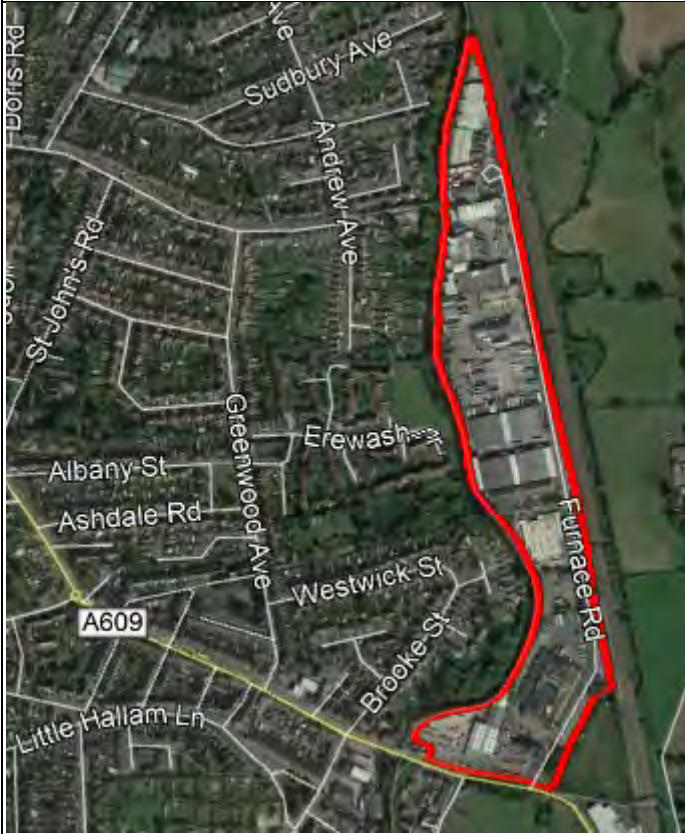

**GROSS SITE AREA:
10.39 ha**

**ESTIMATED NET DEVELOPABLE AREA:
0 ha**

CRITERIA	COMMENT	RATING
<p>Site Context</p> <ul style="list-style-type: none"> • Location with regards to existing employment areas and other sites • How the site fits into the overall portfolio 	<p>The site is located on the south-east edge of Ilkeston with Furnace Road Industrial Estate bordering Erewash Valley Cycle and canal to the west and an active railway line and the River Erewash to the east. The site is 4km to the south of Ilkeston train station, an approximately 6-minute drive.</p> <p>The site is in relatively close proximity to other employment areas being located 1.21km to the south of Digby Street and 1.14km to the north of Hallam Fields Industrial Estate.</p>	
<p>Local Plan Designation</p>	<p>The site borders Green Belt to the north and east (Policy GB1)</p>	
<p>Status in SHLAA</p>	<p>N/A</p>	
<p>Planning History</p>	<p>Recent planning history includes:</p> <ul style="list-style-type: none"> • 0317/0056 – Single storey side extension to existing industrial unit – Granted • 0814/0009 – Erection of a building with a single storey link to the main building for use as an MOT testing station for heavy goods vehicles – Granted 	
<p>Current Use and Land Type</p>	<p>An active industrial estate comprising predominantly B2, with some B8 and E-Class premises. The industrial units of the site are in a good condition and are dated from the 1970s onwards, with some more modern additions.</p>	
<p>Occupier Profile</p>	<p>Occupiers of the site include:</p>	

(if partly developed, including % of available land and levels of vacancy onsite)	<p>Belfield Group (supplier and manufacturer of soft furnishings/furniture for domestic use and the leisure industry), Custompak Ltd. (dynamic packaging), Breasley Mattress & Bedding, Derby Sheds, Aquarius Home Improvements, West Transport, PMB Pallet Express Ltd., KRM Building Supplies (with yard area), Dri-Pak Ltd., IZUZU Commercial Trucks and Hopwells (frozen food) van depot.</p> <p>A single unit is vacant on the site.</p>	
Strategic Road Access	Around 4 km to the junction of the A52.	Very Poor
Local Road Access	Access from Ilkeston Road/Nottingham Road (A609) with transit through residential area on both approaches. The junction at Furnace Road provides difficult access with its positioning at the end of a blind bend.	Average
Proximity to Urban Areas and Access to Labour and Services (including public transport / cycling / walking accessibility)	The site is located to the west of Ilkeston and is approximately 2.3 km from the town centre. Parking is available throughout the site with spaces and limited parking restrictions along the east side of Furnace Road. Pedestrian infrastructure is evident throughout the site with connectivity to the wider area. A bus stop is located near the site entrance (approximately 3-minute walk), along the A609 with services to Ilkeston, Cotmanhay, Heanor and Smalley.	Good
Compatibility of Adjoining Uses (including amenity impacts experienced by current/future occupiers and neighbouring areas)	Residential dwellings neighbour the site along its western border, although the Canal forms a buffer. Commercial premises are also evident including Screwfix, Farmwood Timber Products and Travis Perkins.	Poor
Developmental and Environmental Constraints (e.g. size; topography; site access; roads, lighting, landscaping, mains utilities and communications infrastructure; flood risk; contamination; nature and heritage conservation)	<p>The site is shaped as a thin oval narrowing at the tip, with single ingress and egress from the A609 and a small turning area at the end of Furnace Road. As an established industrial estate, the site is connected to main utilities and benefits from street lighting.</p> <p>However, the majority of the site is designated within a Flood Zone 2/ Flood Zone 3 designation (Flood Map for Planning – Gov.uk, 2020) with no opportunities for expansive development given the bordering railway line and residential area.</p> <p>Towards its northernmost point, the site also adjoins the Grade II Listed Soughclose Lock on the Erewash Canal.</p>	Poor
Barriers to Delivery and Mitigation (including ownership constraints -	A key barrier is the risk from flooding given the above designations and any impact of development on the neighbouring Green Belt.	Average / Poor

if known)	However, many of the larger business premises are surrounded by spacious delivery yards which would allow for the extension of these facilities should an operational need arise.	
Market Attractiveness (including appropriateness, vacancy and market activity on site for the type of development proposed)	<p>The site is fully occupied with the exception of a single unit previously used for car and commercial vehicle repairs. The site is marketed by Mather Jamie for a new build warehouse and showroom (approximately 21,000 sq. ft.) “...located on Furnace Road, a well-established industrial location”.</p> <p>The unit will be of high-quality design and built at a cost of £6.50 per sq ft. pa.</p> <p>A number of planning permissions have been granted for various developments across the wider site in recent years which demonstrates a commitment to remaining on the estate, whilst the high degree of flood risk and the tightly defined boundary with the rail line and canal could render more sensitive land uses potentially inappropriate without substantial mitigation measures.</p>	Good
Strategic Fit with Growth Area Objectives (by target Market Segment)	<p>The following industrial growth sectors are already located within the site:</p> <ul style="list-style-type: none"> • Construction • Logistics & E-Commerce <p>The site is located outside but between the Derby and Nottingham ‘Regional Centres’ (as identified in the D2N2 Vision 2030 document).</p>	Average
OVERALL SITE RATING	Average	
Recommendation and Potential Future Uses	<p>Protect for Employment Use</p> <p>Given the site’s established use as an industrial estate, which is almost fully occupied by a wide variety of premises and operations, its strong contribution to the local economy, and lack of alternative uses given the flooding constraints, suggest that the site should be protected for employment use going forward.</p>	
SITE SUMMARY:		
<p>The site is located at the south-east edge of Ilkeston and is occupied by B2, and to a lesser extent B8 and E Use Class businesses. The site is almost fully occupied and is unable to expand its boundaries given the physical constraints of the bordering railway line, canal, River Erewash and residential dwellings. The estate is fully occupied with the exception of a single unit that is vacant but is advertised for redevelopment for an extension to the existing unit to create c.21,000 sq ft. of new employment space. This demonstrates the site’s popularity. Flood risk, given the site’s proximity to the canal and river, is unsurprising but may present difficulties for expansion / delivery of alternative, more sensitive uses going forward. As an established employment site it should be protected for ongoing employment use.</p>		

Digby Street Industrial Estate (Ref: EBC13)



GROSS SITE AREA:
8.47 ha

ESTIMATED NET DEVELOPABLE AREA:
0.49 ha
(two small plots of vacant land to the south east)

CRITERIA	COMMENT	RATING
<p>Site Context</p> <ul style="list-style-type: none"> • Location with regards to existing employment areas and other sites • How the site fits into the overall portfolio 	<p>Digby Street Industrial Estate is located to the west of Ilkeston, with Ilkeston train station c.0.13km to the north and Cossall Industrial Estate across the railway bridge to the east. Waterside Retail Park neighbours the park to the north-west with the River Erewash flowing along the site's western border.</p>	
<p>Local Plan Designation</p>	<p>To the east and south of the site is designated Green Belt (Policy GB1).</p>	
<p>Status in SHLAA</p>	<p>N/A</p>	
<p>Planning History</p>	<p>Recent planning history includes:</p> <ul style="list-style-type: none"> • 1215/0035 – New build B1/B8 industrial unit and associated external works – Granted • 1018/0055 – Demolition of existing buildings, erection of new build industrial unit & associated external works – Granted • 1016/0016 – Demolition of existing buildings and erection of units for B1 light industrial/B8 storage purposes and associated works – Granted 	
<p>Current Use and Land Type</p>	<p>A quiet industrial estate with a mixture of buildings including the 2 prominent Mill buildings (Armstrong Victorian Mill and Albany Mill) to relatively modern industrial units. Overall the buildings in the northern part of the site are in a poor/average condition and fall within the class E, Sui Generis and B2 uses.</p>	

<p>Occupier Profile (if partly developed, including % of available land and levels of vacancy onsite)</p>	<p>Occupiers of the site include: Alfa Star, Safety Signs & Notices, Perfect Tint, TLF Utilities Ltd., Trade Spray UK, Digby Art Studio, RT Trade Cars Ltd. / JMMC Motors Ltd., Digby Autos / Polished Reflections, TLF Utilities Ltd., Wholesale Car Company Ltd., Wheelchair Adapted Cars, Polished Reflections Auto Valeting, AMCOR (packaging for food, beverage, pharmaceutical, medical, home and personal care products), Armstrong Antiques, Millies the Restaurant, R. A. Labone & Co. Ltd (plastic injection mouldings, metal pressings, insert mouldings and tool design and manufacture).</p> <p>R. A. Labone and AMCOR are the dominant occupiers of the site, occupying approximately 2.4 ha of the land area.</p> <p>Two units are vacant on the site (as detailed on the Digby Business Park signage) although much of Armstrong Mill itself appears to be vacant. On entry along Digby Street, No3 factory is in a rundown condition with no occupier evident. The units to the east of the site are also vacant and in a particularly distressed condition. The area of land measures approximately 0.9 ha, with parts of the units under demolition (Pure Construction). An area of land within the central position of the site is vacant of any units (along Truman Street), the patch of land measures approximately 0.1ha and is currently used for the storage of building materials such as unused bricks and fencing.</p> <p>Adjacent to Amcor, a grassed area of land is also vacant and measures c.0.49 ha. In total, it is estimated >20-30% of the site is vacant.</p>	
<p>Strategic Road Access</p>	<p>Within 1 km of the A6007 to the west and a further 3 km to the A610.</p>	<p>Average / Poor</p>
<p>Local Road Access</p>	<p>Access from Station Road/Coronation Road, with a difficult junction at the top of Digby Street as a consequence of the opposite junction at Wentworth Street and the adjacent Station Street junction adjoining Station Street/Coronation Road, all within very close proximity.</p>	<p>Average</p>
<p>Proximity to Urban Areas and Access to Labour and Services (including public transport / cycling / walking accessibility)</p>	<p>The site is approximately 2.2km from Ilkeston town centre, with good pedestrian infrastructure connecting to the wider area. Ilkeston train station (c.0.13km) to the north east provides services to Nottingham, Liverpool Lime Street and Leeds with the railway line bordering the site to the east. Digby Street bus stop positioned opposite Waterside Retail Park with a stop located on both sides of Station Street. The stops provide services towards Swingate and Awworth. There no cycleways or cycle infrastructure on the site or in the immediate locality.</p>	<p>Very Good / Good</p>

<p>Compatibility of Adjoining Uses (including amenity impacts experienced by current/future occupiers and neighbouring areas)</p>	<p>The site is bound by the Green Belt (Policy GB1) to the east and the south. On entry to Digby Street and adjoining the employment area are c.9 terraced homes with additional residential dwellings at the top of the street and The DewDrop Inn/Ilkeston Junction Free House. There are no sensitive uses to the south or east.</p>	<p>Average</p>
<p>Developmental and Environmental Constraints (e.g. size; topography; site access; roads, lighting, landscaping, mains utilities and communications infrastructure; flood risk; contamination; nature and heritage conservation)</p>	<p>The site is rectangular in shape with Digby Street running in a north-south direction – terminating at AMCOR at the southern tip of the site. The site has limited street lighting with the older buildings creating a tired landscape. A classic red brick industrial building, Armstrong Mill is a prominent feature in the landscape but is not defined on Map search as a listed building.</p> <p>Adjacent to the River Erewash the majority of the site is designated within Flood Zone 3 with some scattered patches within Flood Zone 2 (Flood Map for Planning – Gov.uk, 2020). This has implications for restricting most forms of new development and it is understood that previous flooding events have impacted upon this part of Ilkeston.</p>	<p>Poor</p>
<p>Barriers to Delivery and Mitigation (including ownership constraints - if known)</p>	<p>A key barrier is the risk from flooding given the above designations and any impact of development on the neighbouring Green Belt.</p>	<p>Average</p>
<p>Market Attractiveness (including appropriateness, vacancy and market activity on site for the type of development proposed)</p>	<p>Between 20-30% of the site is vacant/undeveloped, with much of the buildings of the site being in a poor condition. Despite apparent vacancies/absence of occupiers there are no marketing signs on the site. The units on Digby Street also neighbour residential dwellings. The site is seeing some redevelopment and investment given the recent planning permissions.</p> <p>Mill premises on-site may also have the potential for being converted to accommodate a mix of new uses.</p> <p>The inclusion of most of the site within the functional flood plain will place strict restrictions on the ability to construct new development at the estate.</p>	<p>Average / Poor</p>
<p>Strategic Fit with Growth Area Objectives (by target Market Segment)</p>	<p>The following industrial growth sectors are already located within the site:</p> <ul style="list-style-type: none"> • Creative & Digital <p>The site is located outside but between the Derby and Nottingham ‘Regional Centres’ (as identified in the D2N2 Vision 2030 document).</p>	<p>Poor</p>
<p>OVERALL SITE RATING</p>	<p>Average / Poor</p>	

<p>Recommendation and Potential Future Uses</p>	<p>Allocate for employment uses</p> <p>Despite the number of vacancies and unoccupied units on the site, the planning history indicates a renewed interest in the employment area and it is located in a sustainable location close beside the railway station and within walking distance of the town centre. The site has good public transport links and pedestrian connectivity to the town centre, although there are a number of vacancies and the site suffers from a high degree of flood risk.</p> <p>The site should be allocated for employment use and the remaining plots allocated for such uses, although there may be opportunities for refurbishing the existing Mill premises for a mixture of new uses to ensure its ongoing viability.</p>
--	---

SITE SUMMARY:

The site is located to the west of Ilkeston and contains a number of Class B2, Sui Generis and E premises. Several of the buildings are in a poor condition with the remaining in an average state, the premises also vary in age from the old Armstrong Mill to relatively modern industrial units. The site has an estimated 20-30% vacancies but the planning history indicates a level of interest remains for the site. The site benefits from connectivity to the adjoining railway and the site should capitalise on the existing linkages with routes to Nottingham, Liverpool and Leeds. Flood risk on the site is likely to prohibit the development of sensitive uses for this site. The site should be allocated for employment use, with the remaining vacant plots allocated for that use.

Manners Industrial Estate (Ref: EBC14)



GROSS SITE AREA:
23.45 ha

ESTIMATED NET DEVELOPABLE AREA:
0 ha

CRITERIA	COMMENT	RATING
<p>Site Context</p> <ul style="list-style-type: none"> • Location with regards to existing employment areas and other sites • How the site fits into the overall portfolio 	<p>The site is located to the west of Ilkeston town centre with Pewit Golf Course to the south of the site and a retail area that expands to the south-east.</p> <p>The site was constructed in the 1980s on the former Manners Coal Mine.</p> <p>The breadth of business activities conducted on the estate fulfil six of the key industrial growth sectors targeted by D2N2.</p>	
<p>Local Plan Designation</p>	<p>The site borders Pewit Golf Course (Policy R6) and a designated Site of Special Scientific Interest, Regionally Important Geological Sites and Geological Sites and Geomorphological Sites, Local Nature Reserves and Site of Importance for Nature Conservation (Saved Policy EV 10, Manor Floods) to the west.</p>	
<p>Status in SHLAA</p>	<p>Reference; 172 (91 dwellings)</p> <p>The designation covers part of the site to the east.</p> <p>Site not considered suitable for residential development (SHLAA, 2019).</p>	
<p>Planning History</p>	<p>Recent planning history includes:</p> <ul style="list-style-type: none"> • 1112/0033 – Erection of three commercial units (Class B1 – Business) – Granted • 0913/0011 – Extensions to industrial units – Granted • 0113/0019 – Change of use from general industrial (B2) to snooker hall (D2) – Granted • 0914/0057 – Provide extension for additional showroom – Granted 	
<p>Current Use and Land Type</p>	<p>A mixed use and active industrial estate comprising of around</p>	

	89 occupants defined within the Class E, B2, B8 and Sui Generis use classes . The industrial estate is well kept, with units positioned on a central island with a circular road and industrial units surrounding the centre.	
Occupier Profile (if partly developed, including % of available land and levels of vacancy onsite)	Occupiers of the site include: Kudos Packaging, Cluny Lace, H & J Supplies, Major & Naylor Joinery, Eastwood Care Homes Plc, Sterling Business Systems, Total Engineering Power Press, Major Concrete, Dremm Packaging, Moldex Metric, Automation Systems Ltd, Springfield Leisure, Active Direct, Printglaze, D & K Hartle, Martool, MB Welding Supplies, Herbert Robinson Print, Skymark, Wentworth International, Sign Systems, Warm & Cosy, Fashion Ribbon, Mintex Engineering Ltd., Sherwood Scaffolding, D & J Fabrications, Contour Furnishings, Kendon Packaging, Cladceil, Newey & Eyre, CPI, Aktiv Computer Products Ltd, Orient Gold – Admin Centre, Stork Talk, Midland Catering Supplies, Panel Kraft, MET Technical Displays, RFT Packaging Supplies, Gladex, Hindle Power, Wilmot Bros, Profile Glass, Bardini Plastics, Rod Lacy Concrete Repairs, Orient Gold – Bus Dev Centre, Diaploy, Orient Gold – Ops Centre, RMH Refinishers, MBL Transport Equipment Ltd, Sue Ryder Foundation, CEF, Europe Express Freight, Primary Products, Time Design, IMS, J G Engineering, Precision Plastics, Vehicle Wiring Products, Skinner, Rook and Chambers, S & S Plastics, KPP Converters, National Packaging, Refuse Amenity Site, Manor Fencing & Concrete, Columbia Metals, Peak Packaging, Royal Mail, Custom Pak, East Midlands Engine Servicing, Merritt Plastics Ltd., Cavendish Cartons, Derbyshire County Council and Roberts Bakery. Of the 89 units, just 6 are vacant.	
Strategic Road Access	The B6007 adjoins the A6007 via a 5-arm roundabout. It is many miles away from the nearest junction with the M1.	Average / Poor
Local Road Access	Access through Manor Road/B6007 passing residential dwellings and Victoria Park Care home.	Poor
Proximity to Urban Areas and Access to Labour and Services (including public transport / cycling / walking accessibility)	The industrial estate is in relatively close proximity to Ilkeston town centre where all amenities are available, with the site connected to the adjoining area by pedestrian infrastructure. There are no connecting cycleways or cycle infrastructure on the industrial estate. There are no bus services on the site itself, with the nearest being located on Mason Road to the north and Lord Haddon Road to east of site – both between 0.5-1km of the industrial estate.	Average
Compatibility of Adjoining Uses (including amenity impacts experienced by current/future)	The site neighbours residential areas to the north, east and south separated by vegetated borders with	Average / Poor

occupiers and neighbouring areas)	the recycling centre itself backing onto a residential cul-de-sac. To the west, the site borders a designated SSSI, Regionally Important Geological Sites and Geological Sites and Geomorphological Sites, Local Nature Reserves and Site of Importance for Nature Conservation (Saved Policy EV 10, Manor Floods).	
Developmental and Environmental Constraints (e.g. size; topography; site access; roads, lighting, landscaping, mains utilities and communications infrastructure; flood risk; contamination; nature and heritage conservation)	<p>The site is circular in shape with industrial units positioned on a central island and other units encircling the centre, separated by Manners Avenue. The site has a single ingress and egress route with limited parking restrictions throughout the estate. Street lighting is positioned throughout the site and limited parking measures on in force. As an established industrial estate, the site is serviced by utilities.</p> <p>A review of Flood Maps for Planning (Gov.uk, 2021) shows the site is not located within a flood zone.</p> <p>The site was built on a former Colliery (Manners Coal Mine), and there are records of landfill situated beneath ground level here. Future extensive redevelopment of premises has a limited potential to disturb harmful landfill if such works are not conducted sensitively.</p>	Good
Barriers to Delivery and Mitigation (including ownership constraints - if known)	The site offers a wide range of industrial premises and facilities, with many of the units having already been altered, adapted and enlarged to meet their occupiers' specific operational requirements. Given the Estate's layout, detached units have excellent opportunities to modify in order to allow for business growth.	Very Good
Market Attractiveness (including appropriateness, vacancy and market activity on site for the type of development proposed)	<p>The site has high levels of occupation with just 6 units of the 89 vacant. An advertising board from BB & J (Commercial Property and Land Agents) offers a trade counter/workshop unit (from 2,369 sq ft. – 7,464 sq ft.) to let, however the unit is no longer available on the agent's website. Secondly, Halls 1845 are advertising a modern commercial premise totalling 1.54ha for sale at a cost of £2,900,000. The premises are for sale due to relocation and is currently under offer.</p> <p>The Estate has an excellent reputation locally as a place of business, and it is understood that when vacancies do arise, they only remain on the market for a relatively short period of time.</p>	Very Good

<p>Strategic Fit with Growth Area Objectives (by target Market Segment)</p>	<p>The following industrial growth sectors are already located within the site;</p> <ul style="list-style-type: none"> • Transport Equipment Manufacturing • Food & Drink Manufacturing • Creative & Digital • Logistics & E-Commerce • Construction • Professional Business Service <p>The site is located outside but between the Derby and Nottingham 'Regional Centres' (as identified in the D2N2 Vision 2030 document).</p>	<p>Very Good</p>
<p>OVERALL SITE RATING</p>	<p>Very Good</p>	
<p>Recommendation and Potential Future Uses</p>	<p>Protect for Employment Use</p> <p>The site is within close proximity to Ilkeston town centre and benefits from high levels of occupation within a large, very popular and well-established industrial estate of mixed-use businesses. The activities of the occupiers of the site fall within six of the key industrial growth sectors identified by D2N2. The estate should be protected for ongoing employment use.</p>	
<p>SITE SUMMARY:</p>		
<p>The site contains a diverse range of businesses classified as Class E, B2, B8 and Sui Generis premises. The Industrial Estate itself is occupied by c.89 businesses with just 6 premises vacant. Since conducting the site visit one of the industrial units is no longer available and the second is under offer. The diverse range of occupiers across the estate incorporates six of the key industrial growth sectors targeted by D2N2. Consequently, this very popular site should be protected for employment use going forward.</p>		

Great Bear Industrial Estate (Ref: EBC15)



**GROSS SITE AREA:
5.43 ha**

**ESTIMATED NET DEVELOPABLE AREA:
0 ha**

CRITERIA	COMMENT	RATING
<p>Site Context</p> <ul style="list-style-type: none"> • Location with regards to existing employment areas and other sites • How the site fits into the overall portfolio 	<p>The site is located within Sandiacre and to the south-west of Stapleford. The site borders Progress Rail UK to the east, with retail units including Lidl and Burger King to the north.</p> <p>The commercial premises on site compliment the bordering 'Town and Local Centres designation (Policy 6, 2A).</p>	
<p>Local Plan Designation</p>	<p>To the immediate north, the site borders the Sandiacre 'Town and Local Centres' designation (Policy 6, 2A).</p>	
<p>Status in SHLAA</p>	<p>Reference; 282 (for 33 dwellings) and 270 (for 85 dwellings) Site is not suitable for residential development (SHLAA, 2019).</p>	
<p>Planning History</p>	<p>Recent planning history includes;</p> <ul style="list-style-type: none"> • 1113/0034 – Change of use from B8 (storage & distribution to B2 (manufacture) – Approved 	
<p>Current Use and Land Type</p>	<p>Large units/depot for class E, B2 and B8 use. The buildings are in an average/good condition, originating in the late 19th Century when the western side of the site accommodated a large gas engine works. This building has been modernised and altered to allow it to accommodate warehousing, whilst other units on the site date from the 1990s to early 2000s. "My" Showroom/Furniture in particular has a modern metallic façade.</p>	
<p>Occupier Profile (if partly developed, including % of available land and levels of vacancy onsite)</p>	<p>Occupiers of the site include:</p> <p>TCW Logistics (Block A)</p>	

	<p>Bonnington Plastics Ltd (Block B) D X Network Ltd (Block C) “My” Showroom and “My” Furniture Progress Rail Operations Centre (offices)</p> <p>The site has no vacancies.</p>	
Strategic Road Access	<p>Although visible from the A52 to the south, access to the road and the M1 beyond is convoluted requiring a drive of over 1.5 km through residential areas. The site is within 2.3 km of Sandiacre Interchange with access to the A52 and M1.</p>	Poor
Local Road Access	<p>The site leads to the B5010 which proceeds through residential areas with retail frontages.</p>	Poor
Proximity to Urban Areas and Access to Labour and Services (including public transport / cycling / walking accessibility)	<p>A Lidl supermarket and Burger King drive-thru are located at the top of Mark Street. The site is also serviced by good pedestrian infrastructure with connectivity to the town centre of Sandiacre (c.1km to the north). The site does not benefit from any cycle infrastructure, but two bus stops are located along the B5010 with one opposite and the other in front of the Lidl supermarket with services to Nottingham, Ilkeston, Sandiacre, Sawley, Derby and the East Midlands Airport.</p>	Very Good
Compatibility of Adjoining Uses (including amenity impacts experienced by current/future occupiers and neighbouring areas)	<p>The site borders the Progress Rail UK site to the east, and residential areas to the north and west (although the canal and vegetation provide a substantial buffer.</p> <p>The adjoining high-street contains a mix of retail premises including restaurants/takeaways, furniture, locksmiths and a convenience store.</p>	Average
Developmental and Environmental Constraints (e.g. size; topography; site access; roads, lighting, landscaping, mains utilities and communications infrastructure; flood risk; contamination; nature and heritage conservation)	<p>The site is constrained by a canal to the west and the A52 to the south. The site is regular in shape, with access from Mark Street. As an established site it is serviced by utilities and communications infrastructure.</p> <p>The site’s storage and distribution use generates high volumes of HGV traffic through the centre of Sandiacre’s Conservation Area, which is not ideal and take large vehicles through sensitive and historic environments. It also brings HGVs into close contact with shoppers and pedestrians in the settlement’s centre.</p>	Poor

	The site is also designated within Flood Zone 2 (Flood Map for Planning, Gov.uk).	
Barriers to Delivery and Mitigation (including ownership constraints - if known)	None observed other than the aforementioned comments concerning the current difficulties for ongoing logistics movements and likely future conflicts.	Good
Market Attractiveness (including appropriateness, vacancy and market activity on site for the type of development proposed)	The site is fully occupied and within the locality of Sandiacre. There have been a number of recent improvements in the warehousing on the site which demonstrates a commitment to the area for the foreseeable future.	Good
Strategic Fit with Growth Area Objectives (by target Market Segment)	The following industrial growth sectors are already located within the site: <ul style="list-style-type: none"> • Logistics & E-commerce • Retail The site is located outside but between the Derby and Nottingham 'Regional Centres' (as identified in the D2N2 Vision 2030 document).	Average
OVERALL SITE RATING	Average	
Recommendation and Potential Future Uses	Protect for Employment Use This is a fully occupied site that is adjacent to Progress Rail UK (containing office facilities). It has seen recent investment in the existing warehousing facilities and should be protected for employment uses going forward. That said, the site's HGV movements potentially conflict with the amenity of adjoining residential and heritage areas and environmental / highways improvements could be necessary going forwards if the site is to remain in use for B8 over the longer term.	
SITE SUMMARY:		
<p>The site is located within the town of Sandiacre and to the south-west of Stapleford. The Great Bear industrial estate is fully occupied containing class E, B2 and B8 businesses such as "My" Showroom/Furniture, TCW Logistics, Bonnington Plastics Ltd and D X Network Ltd. The site is beside bus routes and has pedestrian infrastructure to the wider area. The site should be protected for employment use at present, although concerns remain over its long-term suitability for logistics, given its proximity to residential areas and the Sandiacre Conservation Area.</p>		

Stanton Bonna Concrete Plant and Works (Ref: EBC16)

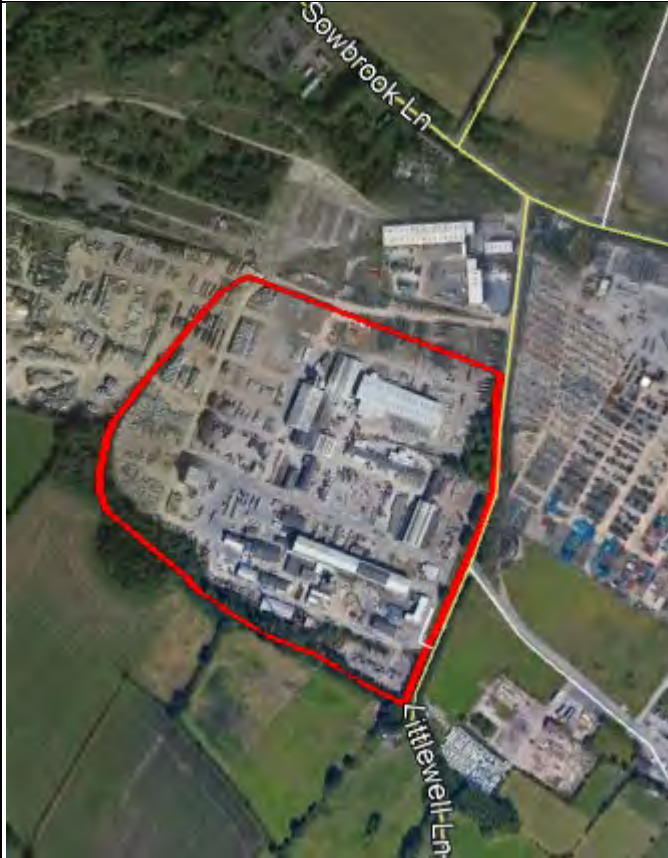

**GROSS SITE AREA:
13.44 ha**

**ESTIMATED NET DEVELOPABLE AREA:
0 ha**

CRITERIA	COMMENT	RATING
<p>Site Context</p> <ul style="list-style-type: none"> • Location with regards to existing employment areas and other sites • How the site fits into the overall portfolio 	<p>This Concrete Works is located to the south of the town of Ilkeston (c.3.4 km) and north of the village of Stanton by Vale (c.1 km). The nearest train station is in Ilkeston approximately 4.6km away.</p> <p>The site is part of a wider employment area with PAM Saint-Gobain adjacent and Quarry Hill Industrial Estate, Hallam Fields Industrial Estate and Crompton Road Industrial Estate to the north. Pam Saint-Gobain is designated within the Stanton Ironworks Regeneration (Policy 20: Stanton Regeneration site) that extends further to the east.</p>	
<p>Local Plan Designation</p>	<p>No planning designations to note. However, to the immediate east of the site is Stanton Ironworks Regeneration (Policy 20: Stanton Regeneration Site).</p>	
<p>Status in SHLAA</p>	<p>N/A</p>	
<p>Planning History</p>	<p>Recent planning history includes;</p> <ul style="list-style-type: none"> • 0817/0044 – Erection of new concrete batching plant, including aggregate bins, bucket track/overhead gantries and associated development • 0519/0070 – Erection of new industrial building to house a concrete slab and wet casting facility, and other associated works (revised scheme, partly retrospective, following approval of previous scheme under application 	

	reference ERE/1217/0050)	
Current Use and Land Type	The site is used by Stanton Bonna Concrete Ltd, a leading UK manufacturer of precast concrete pipes, manholes and culverts for drainage for use in the construction industry and is classified as use class B2 with some ancillary Class E (office) use.	
Occupier Profile (if partly developed, including % of available land and levels of vacancy onsite)	The site is fully occupied by Stanton Bonna Concrete Ltd containing a mix of modern and 1990s industrial units in an average/good condition. The site is made secure by an external fence and gated security entrance with reception adjacent. The site also contains offices (dated from the 1990s) and storage yards for the concrete goods.	
Strategic Road Access	Access from Lows Lane/Littlewell Lane with the site being 3.7km from an M1 junction. However, vehicles with a 7.5 tonne weight cannot head south on Littlewell Lane towards Stanton by Dale, and restrictions for HGVs prevent access to the M1 along this route.	Very Poor
Local Road Access	Access from Littlewell Lane	Average
Proximity to Urban Areas and Access to Labour and Services (including public transport / cycling / walking accessibility)	The site is not accessible by cycle or pedestrian infrastructure, nor is it serviced public transport. The nearest town centre of Ilkeston (c.3.4)km, to the north an approximate 5-minute drive), has retail and eatery facilities such as Tesco Express, Morrisons and Asda.	Very Poor
Compatibility of Adjoining Uses (including amenity impacts experienced by current/future occupiers and neighbouring areas)	<p>The site forms part of a wider employment area including PAM Saint-Gobain Stanhope (cast iron drainage & rainwater systems) adjacent, forming part of the Stanton Regeneration Site (Policy 20) that extends further to the east. Just north of the site is Quarry Hill Industrial Estate, Hallam Fields Industrial Estate and Crompton Road Industrial Estate.</p> <p>Therefore whilst the bad neighbour uses associated with this concrete works are not an issue at present, there is a clear risk that this could change in future depending on the redevelopment of the large mixed use Stanton Regeneration site to the east, and therefore careful consideration will have to be given to ensure that future residents' amenity is not adversely affected, whilst ensuring that this successful and important concrete works is able to continue its current industrial operations without restriction.</p>	Very Good

<p>Developmental and Environmental Constraints (e.g. size; topography; site access; roads, lighting, landscaping, mains utilities and communications infrastructure; flood risk; contamination; nature and heritage conservation)</p>	<p>The site is square in shape and is flat in appearance. The site is accessed for visitors to the south east via a security barrier, with access to the rear and centre of the site for working vehicles to the north east. Agricultural land borders the site to the south and the west with some residential dwellings to the north separated by some vegetation.</p> <p>A review of Flood Maps for Planning (Gov.uk, 2021) shows the site is not located within a flood zone.</p>	<p>Very Good</p>
<p>Barriers to Delivery and Mitigation (including ownership constraints - if known)</p>	<p>Should the site become available remediation would certainly be required.</p>	<p>Poor</p>
<p>Market Attractiveness (including appropriateness, vacancy and market activity on site for the type of development proposed)</p>	<p>The site is exclusively occupied by Stanton Bonna and has been developed over the years for their very specific operational use. Recent investment made by the company in the development of new facilities demonstrate their long-term commitment to the site, although should they wish to relocate in the future then the associated structures on site would be difficult to convert to alternative uses.</p> <p>A new occupier would likely face a cost in removing such structures and remediating the site.</p>	<p>Average</p>
<p>Strategic Fit with Growth Area Objectives (by target Market Segment)</p>	<p>The following industrial growth sectors are already located within the site;</p> <ul style="list-style-type: none"> • Construction <p>The site is located outside but between the Derby and Nottingham 'Regional Centres' (as identified in the D2N2 Vision document 2030).</p>	<p>Average</p>
<p>OVERALL SITE RATING</p>	<p>Average</p>	
<p>Recommendation and Potential Future Uses</p>	<p>Protect for Employment Use Given the established and niche use of the site by a well-known business and sector leader, the site should retain its protection for employment use. The facility makes an important contribution to the Borough's economy and recent investment made by the company in the development of new facilities demonstrates their long-term commitment to the area.</p>	
<p>SITE SUMMARY:</p>		
<p>The site is occupied by Stanton Bonna Concrete Plant and Works, a Class B2 use. The site is located to the south of Ilkeston and just north of Stanton by Dale. The site is fully developed for a niche use and forms part of a wider employment area that includes Quarry Hill Industrial Estate, Hallam Fields Industrial Estate and Crompton Road Industrial Estate to the north with PAM Saint-Gobain Stanhope adjacent that forms part of the Stanton Regeneration Site (Policy 20) extending further to the east. As an established and important site to the local economy, the site should be protected for employment use. Future development of the Stanton Regeneration site to the east will need to balance the amenity issues of new residents with the need to preserve the ongoing operational</p>		

requirements of the site.

Top Wighay Farm (Ref: GBC1)



**GROSS SITE AREA:
8.55 ha gross**

**ESTIMATED NET DEVELOPABLE AREA:
6.5 ha net based on planning application
ref. 2020/0050**

CRITERIA	COMMENT	RATING
<p>Site Context</p> <ul style="list-style-type: none"> • Location with regards to existing employment areas and other sites • How the site fits into the overall portfolio 	<p>The site borders agricultural land to the north and is bound by the A611 (Annesley Road) to the south with a single-track road along the site's eastern boundary. The site is located on the northern edge of the town of Hucknall with the land c. 5.10 km to the south-east of Sherwood Business Park.</p> <p>The site is allocated as a Strategic Allocation in the 'Greater Nottingham Aligned Core Strategy Part 1 Local Plan' and the 'Aligned Core Strategy Policies Map' (adopted 2014) (Policy 2: The Spatial Strategy).</p> <p>The Strategic Allocation forms part of a 35.6ha Sustainable Urban Extension of 1,000 dwellings of which 8.5 ha of land is allocated for B1 (Business) (replaced by Class E (Commercial, Business and Service) as of 1st September 2020) and B8 (Storage and Distribution) use.</p> <p>An outline planning application for development of the site is pending determination.</p>	
<p>Local Plan Designation</p>	<p>The site is allocated in the 'Aligned Core Strategy Part 1 Local Plan' and the 'Aligned Core Strategy Policies Map' (adopted 2014) as a Strategic Allocation (Policy 2: The Spatial Strategy).</p> <p>Other designations include:</p> <ul style="list-style-type: none"> • Policy 4: Employment Provision and Economic Development; • Policy 18: Infrastructure; • Policy 16: Green Infrastructure, Parks and Open Space, the site is part of a general designation covering the 	

Gedling Colliery/Chase Farm (Ref: GBC2)

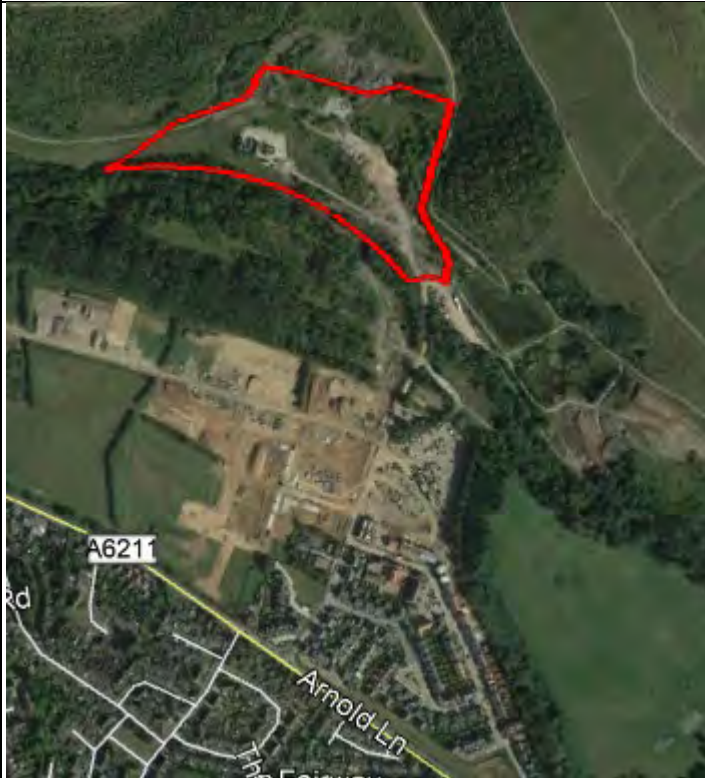

**GROSS SITE AREA:
4.12 ha**

(Source: planning application 2017/1571)

**ESTIMATED NET DEVELOPABLE AREA:
2.45 ha**

(application ref. 2017/1571, DAS, p.9)

CRITERIA	COMMENT	RATING
<p>Site Context</p> <ul style="list-style-type: none"> • Location with regards to existing employment areas and other sites • How the site fits into the overall portfolio 	<p>The site is bordered by Gedling County Park to the north with construction of 1,050 dwellings immediately to the south of the site (ref. 2015/1376). The Colliery/Chase farm is adjacent to Arnold Lane (A6211) connected via Waldrom Road, a spur road. The nearest town is Arnold, which is located c. 4.02 km from the site; Gedling Village c.1.6km to the south-east; and a significant solar farm located c. 0.75 km to the east of the site (installed on the east tip of the spoil heap and providing power for c.1,800 local homes per year) (Gedling Country Park Management Plan, 2019)</p> <p>Having been identified as a Strategic Location and an allocated site for employment, the recently approved application (ref. 2017/1571) capitalises on the site's employment characteristics (particularly on completion of the Gedling Access Road) and designations.</p>	
<p>Local Plan Designation</p>	<p>The site is allocated in Gedling's 'Local Planning Document Part 2 Local Plan' (LPD P2) (adopted July 2018) for employment-led mixed-use development (Policy LDP 71) and identified as a Strategic Location in the Council's 'Aligned Core Strategy Part 1 Local Plan' (adopted 2014) (Policy 2: The Spatial Strategy).</p> <p>The vision of Policy 2 aims to achieve sustainable development in the plan area through a strategy of urban concentration with regeneration opportunities. The site is key to this objective through the regeneration of brownfield land to create employment opportunities.</p>	

	<p>The Gedling Colliery/Chase Farm site is identified as a strategic location in the Aligned Core Strategy and required by Policy 4 of the Aligned Core Strategy to include significant economic development. Outline planning consent has been granted for up to 1,050 homes, a local centre and a primary school on the majority of this site; however, the former pit head part of the site allocated for employment uses in the Gedling Borough Replacement Local Plan (2005) is not included within this outline planning permission.</p> <p>The supporting text to the Policy states that: <i>“The land to the north of the Gedling Access Road is allocated for 5 hectares of employment-led mixed-use development. This is in recognition that a wider range of employment uses is required to help facilitate the development of this former colliery through an element of “pump priming” as the site has remained undeveloped for a number of years. It also recognises that the site’s location adjoining the newly opened Gedling Country Park presents new opportunities for visitor related facilities that could provide significant levels of employment. The types of employment led mixed uses that the Borough Council would consider acceptable include an element of food and drink, such as pub/diner and coffee shop or other facilities connected with the Country Park. It is considered that the amount of pump-priming development can be determined through the detailed planning process taking into account site viability. The site would be developed predominantly for suitable business (B1), storage and distribution (B8) and general industry (B2) uses, subject to the latter being appropriate in this location (which may require the imposition of suitable conditions on any planning permission).”</i> [para 10.3]</p> <p>Other designations within the site include;</p> <ul style="list-style-type: none"> • Aligned Core Strategy (Policy 15) makes provision for the Gedling Access Road. • Local Wildlife Site (Policy LPD 18) • Protected Open Space adjoins the north-west border (Policy LDP 20)
Status in SHLAA	Reference: 6/131
Planning History	<p>Recent planning history includes;</p> <ul style="list-style-type: none"> • 2017/1571 – Outline planning permission for the erection of employment units (Class B1c/B2/B8 Use) (5,574 sqm), Pub/Restaurant (Class A3/A4 Use) and Drive Thru (Class A3 Use), together with associated parking, servicing and landscaping – Granted (21 July 2020)
Current Use and Land Type	Majority of site under construction (ground works and access) with building of a retaining wall predominantly along the northern boundary and a slight length along the southern border.
Occupier Profile	Majority of site under preparation in respect of ground works and access – c.40% (2.15ha)

(if partly developed, including % of available land and levels of vacancy onsite)	
Strategic Road Access	<p data-bbox="612 315 1040 353">Adjacent Arnold Lane (A6211)</p> <p data-bbox="612 389 1362 680">The Gedling Access Road (GAR), a new 3.8km single carriageway road, will connect the A612 at the junction of Burton Road/Nottingham Road and Trent Valley Way to Mapperley Plains to the north. On completion, the GAR will enable and serve the proposed mixed use (housing and employment) redevelopment at the former Gedling Colliery (Planning Statement ref. 2017/1571, 2017)</p> <p data-bbox="612 716 1369 860">Construction of the GAR officially began on February 6 2020, with the project scheduled to be completed in the Autumn of 2021 (Nottinghamshire County Council).</p> <p data-bbox="612 896 1358 1111">The cost of construction totals £40m with funding sourced from multiple stakeholders including; £10.8m from D2N2, £17m from Keepmoat Homes, £5.4m from Nottinghamshire County Council and £7.1m from the Home & Community Agency (D2N2, 2020).</p> <p data-bbox="612 1146 1318 1258">The primary objective of the new access road is to enable the redevelopment of the former Gedling Colliery/Chase Farm.</p> <p data-bbox="612 1294 1366 1688">Policy LPD 58 Cycle Route, Recreational Routes and Public Rights of Way within the LPD P2, details that there is a need to safeguard the former Gedling Colliery rail line as a potential transport corridor for the longer term. In the short term, the Council is promoting the former line as a new recreational route. Further potential tram routes are currently being explored but it is unlikely a scheme linking Nottingham and Gedling, utilising in part the former Gedling Colliery line would be built before the end of the plan period (2011-2028).</p>
Local Road Access	<p data-bbox="612 1729 1369 1872">The site adjoins Arnold Lane (A6211) connected via Waldrom Road, a spur road travelling in a north-east trajectory through a newly, semi-constructed housing estate.</p> <p data-bbox="612 1908 1331 2051">Waldrom Road (built within the last 18 months) is also relatively newly surfaced. At present, the road has minor traffic from the residents and is used by the construction vehicles servicing the site.</p>

	<p>On completion, a new access road will connect directly to the employment area from a northern arm of a new four-armed roundabout.</p>	
<p>Proximity to Urban Areas and Access to Labour and Services (including public transport / cycling / walking accessibility)</p>	<p>The site is in relatively close proximity to Gedling Village, approximately 1.6km to the south-east around a 3-minute drive.</p> <p>The employment area is immediately adjacent to a new housing estate comprising 1,050 dwellings (ref. 2015/1376) which is currently under construction. On completion the development will deliver a new local centre with retail units within walking/cycling proximity to the site (Planning statement ref. 2015/1376). A smooth gravel path is situated on the eastern boundary of the site providing a link to Gedling County Park,</p> <p>A single bus stop is positioned adjacent the site, across the A6211 on Shelford road (c.800 metres from the site) providing services to Gedling. Once Chase Farm is constructed, a bus service will be re-routed, providing a regular service from a stop within 400m of the development (Planning Statement ref. 2017/1571)</p> <p>On completion of the GAR, a new 3m wide shared footway/cycle way, with crossing points on key desire lines will be constructed. The footway/cycle way will be extended into the Gedling Colliery/Chase farm site (Design & Access statement ref. 2017/1571).</p>	<p>Very Good (on completion of site)</p>
<p>Compatibility of Adjoining Uses (including amenity impacts experienced by current/future occupiers and neighbouring areas)</p>	<p>The site is immediately north of a residential area and south of Gedling County Park.</p> <p>The Colliery itself closed on 8th November 1991. with the Country Park opening in 2015, comprising of c.234ha of open space, a children’s play area, visitor centre, walking and cycling trails, viewing platforms and Café 1899. The newly opened park does present new opportunities for the provision of visitor related facilities (Gedling Country Park Management Plan, 2019; Planning Statement ref. 2017/1571).</p> <p>The residential area to the south of the site is allocated for 1,050 homes under Policy LPD 64 Housing Allocations (H9) of Local Planning Document Part 2 and is under construction (ref. 2015/1376). The site is allocated as a Strategic Allocation in the Aligned Core Strategy, the land is subject to a phased programme of implementation to ensure the following are provided;</p>	<p>Average</p>

	<ul style="list-style-type: none"> • Construction of the GAR and necessary junction improvements; • Public Transport facilities to serve the development, linking appropriately to existing highway infrastructure; • A network of footpaths and cycle paths linking the development with Gedling County Park; • A new local centre, retail facilities, health centre and primary school; • A proportion of affordable housing. <p>(Revised Planning Statement, ref. 2015/1376).</p>	
Developmental and Environmental Constraints (e.g. size; topography; site access; roads, lighting, landscaping, mains utilities and communications infrastructure; flood risk; contamination; nature and heritage conservation)	<p>The employment area is located at the base of a sloping hill from Gedling County Park. The developable land area is regular in shape and currently contains a large pool of water at the centre. Along both the north and south of the employment area are tree lines and retaining walls. The site is in its early phase of groundworks and at the time of the site visit there was limited evidence of completed infrastructure. A further constraint is the high voltage cables across the site (Design & Access Statement, ref. 2017/1376).</p> <p>A review of Flood Maps for Planning (Gov.uk, 2021) shows the site is not located within a flood zone.</p>	Average
Barriers to Delivery and Mitigation (including ownership constraints - if known)	<p>Ground works currently underway. Mitigation measures understood to have overcome any existing constraints on the site in regard to contamination (Aligned Core Strategy Part 1 Local Plan, p.172).</p>	Very Good
Market Attractiveness (including appropriateness, vacancy and market activity on site for the type of development proposed)	<p>According to the DAS that accompanied application 2017/1571, on completion, the site will provide a Drive Thru Restaurant (Class A3, 0.20ha), three industrial Units (Class B1c, B2 and B8, 1.6ha), a Public House (Class A3/A4 – 0.50ha) and 0.15ha of car parking.</p>	Good
Strategic Fit with Growth Area Objectives (by target Market Segment)	<p>The site is also located just outside the “Regional Centre” of Nottingham (as identified in D2N2 Vision 2030 document). The Gedling Local Plan Part 2 identifies this site (and as part of the wider residential development) as being one of the Borough’s key brownfield sites to be redeveloped. A key objective set out in the Plan specifically references maximising the regeneration of at the former Gedling Colliery brownfield site. The Plan identifies that “<i>A major priority is to redevelop the Gedling Colliery/Chase Farm site for a mix of uses including residential, employment and a local centre.</i>”</p>	Very Good

OVERALL SITE RATING	Very Good	
Recommendation and Potential Future Uses	<p>Designate for mixed-use with element of employment use (i.e. retain current Local Plan Part 2 designation as an employment led mixed use designation)</p> <p>Site is currently being developed for B-Class employment units, plus a mix of other uses including a Pub/Restaurant and Drive Thru, together with associated parking, servicing and landscaping, which are appropriate uses in this location and will help deliver a sustainable redevelopment of this wider brownfield site.</p>	
SITE SUMMARY:		
<p>The site is a key regeneration opportunity as set out in the Council’s adopted Local Plan Part 2. It is currently under construction for the provision of industrial units, pub and car parking that will provide sustainable employment opportunities for future residents living in the nearby 1,050 home residential area that is also currently under construction. The site is designated as a Strategic Location (Policy 2: The Spatial Strategy), with the underlying rational of the policy to ensure sustainable development of the plan area through urban concentration with regeneration. It is also understood that the site will be serviced by the Gedling Access Road on completion, providing rapid access to the strategic road network and provision of a 3m wide shared footway/cycle way. It is recommended to designate the site for mixed-use with an element of employment use (i.e. retain current Local Plan Part 2 designation as an employment led mixed use designation).</p>		

Colwick Industrial Estate (Ref: GBC3)



**GROSS SITE AREA:
98.37 ha**

**ESTIMATED NET DEVELOPABLE
AREA:
5.5 ha
(former heavy industrial land; 1.1ha
Two Total Petrol sites; 4.39 ha)**

CRITERIA	COMMENT	RATING
<p>Site Context</p> <ul style="list-style-type: none"> • Location with regards to existing employment areas and other sites • How the site fits into the overall portfolio 	<p>Colwick Industrial Estate is an established employment area, and one of the largest in the Greater Nottingham area. The site borders the River Trent to the south and an active railway line to the east. Colwick Loop Road (A612) directly enters the Estate running in an east-west trajectory, dividing the site in two. Beyond the railway line is Victoria Business Park, located to the north-east of the site, which features Victoria Retail Park, Parcelforce Worldwide, Morrisons and TeamSport Go Karting Nottingham. Immediately to the north of the site is Netherfield train station. Across the River Trent to the south is Holme Pierrepont National Watersports Centre featuring a c.2km long Rowing Course.</p> <p>Colwick Industrial Estate is broadly split into 3 zones: to the south of Colwick Loop Road east and west along Private Road No3; and north of Colwick Loop Road along Private Road No7 and No8.</p> <p>The site is identified to be retained for employment and employment uses (Policy LPD 44 in GBC's adopted Local Plan Part 2). The site is also located in close proximity to employment land in Victoria Business Park. There are several vacant units on the site and a parcel of undeveloped land adjacent to the Colwick Loop Road.</p>	
<p>Local Plan Designation</p>	<p>The site is allocated in the '<i>Local Planning Document Part 2 Local Plan</i>' (adopted July 2018) as a site where employment</p>	

	<p>and employment uses will be retained (Policy LPD 44). The supporting text to that Policy states that “<i>Colwick Industrial Estate, which is one of the largest in Greater Nottingham and has a variety of occupiers. This site together with other sites around Netherfield and Colwick provide for a large cluster of firms including some rated in the top 20 in Nottinghamshire and these are well located to provide the accommodation needs of firms relocating from the regeneration areas in Nottingham City.</i>”</p> <p>Other designations within the Estate include:</p> <ul style="list-style-type: none"> • Hazardous Substances (Policy LPD 9), designated only within a central circle of the industrial estate.
Status in SHLAA	N/A
Planning History	<p>Relevant recent planning history includes:</p> <ul style="list-style-type: none"> • 2020/0873 – Full planning application – Midland Catering Road No 5 Colwick Industrial Estate. Demolition of two industrial units and erection of 18 units in 3 blocks for Office, Research and Development and industrial processes suitable in a residential area. B2 General Industrial, and B8 Storage and Distribution use. Conditional Permission. • 2020/0237 – Section 73 planning application – For amendments to planning permission 2013/0500 (as amended by 2016/1177NMA) relating to alterations to the approved Sainsbury’s store and service yard at land south of Colwick Loop Road, Colwick. Since its approval a number of Discharge of Condition Applications have been submitted and are pending a decision. • 2016/1177NMA – Non-material amendment – Application for an NMA to Planning Permission 2013/0500 to allow details required by conditions in respect of the retail and employment proposal to be provided following the implementation of the approved highway works. • 2013/0500 – Hybrid planning application – Construction of A1 retail unit with ancillary restaurant & concession units, service yard, petrol filling station & car wash, car parking, landscaping & highways works (full application) & B1/B2/B8 employment uses (outline application)
Current Use and Land Type	<ul style="list-style-type: none"> • West along Private Road No3 – Use Class B2 and E - Colwick Business Park, Churchill Park, Park House and Chris Allsop Industrial Park; • East along Private Road No 3 – Use Class B2 and Other - heavy industrial occupiers, workshops and activities including waste processing depot;

	<ul style="list-style-type: none"> Private Road No7 and No8 – Use Class B2 and E - vehicle services, industrial units and City Business Park.
<p>Occupier Profile (if partly developed, including % of available land and levels of vacancy onsite)</p>	<p>East along Private Road No 3 – Colwick Tarmac; Cemex Aggregates; ENVA Waste; JRC Civil Engineering; Tiger European Transport Depot; Maxi Ready-Mix Concrete; Valley Canoe Products; Burlington Fabrications Limited; Thomas Garage; and Park Logistics. Overall, the age of premises is between 1970-2000 in a generally average-poor condition. There are 3 areas vacant; Plot D Units to Let, 1.11 hectares of former heavy industry land and 5.75ha of undeveloped open land with approval for a Sainsbury’s Store (see 2020/0237). This parcel of land already has an exit arm constructed from the roundabout on Private Road No3.</p> <p>West along Private Road No 2 – Biffa Nottingham Depot; Radford Holdings Ltd; RADS Document Storage; Hillarys Blinds; Chirs Alison Scrap Metals, Crane Hire; Bertrand Russel Pearce Foundation; PL Developments Ltd, IT Health UK Ltd; SAAF Education; PHP Building Services Ltd; Cars Plant commercials; and Jewsons. The age of premises ranges between Pre-1970 – 1990s with 3-4 recently refurbished units. There are a notable number of vacancies in this part of the Estate: Total UK Nottingham Terminals Butler Fuels (2.2ha, vacant depot with a limited number of sparse buildings in poor condition - Butler Fuels and Total Reception Building with tarmacked land to be demolished and redeveloped); Total Reception Building and tarmacked land (2.19 ha) in poor condition; First Floor Office Space (good condition); Fully refurbished light industrial/warehouse units (4,000 to 12,500 sq ft on a site area of c. 0.24 ha); Light industrial unit (5,670 sq ft on a site are of 0.12ha); Single unit to let on Chris Allsop Industrial Park; Modern Office Accommodation with parking for 10 vehicles (2,117 sq ft); Unit 3, 4A and 4b (22,435 sq ft).</p> <p>Private Road No7 and No8 – CEF; Newson Gale Ltd; Power Tools Plus; N G Direct Car Sales Ltd; Plant Welding & Engineering Ltd; Ken Wilkins Print; Masons Timber Products; County Truck Service; and Goodman metal works. The buildings ages are generally post 2000 in good condition. There is a single vacant unit at City Business Park.</p> <p>In total, across all three zones there is approximately 5.5ha of disused buildings/land that would require demolition and rebuilding The sites are already serviced on the industrial estate and could be subdivided for the provision of smaller units.</p>
<p>Strategic Road Access</p>	<p>Adjoins the Colwick Loop Road (A612), running through the site in an east-west trajectory.</p> <p style="text-align: right;">Average</p>

<p>Local Road Access</p>	<p>Private Road No 1, 2, 3, 7 and 8. Traffic Light junctions provide access onto the A612.</p> <p>The local roads are in private ownership, Private Road NO 3 in particular is subject to HGV traffic and would benefit from some restoration.</p>	<p>Good</p>
<p>Proximity to Urban Areas and Access to Labour and Services (including public transport / cycling / walking accessibility)</p>	<p>The site is within; 1.12km (approximately 3-minute drive) from Netherfield Local Centre; 1.7 km (approximately 5-minute drive) from the village of Gedling and 7.2km from the town of Arnold (approximately 14-minute drive).</p> <p>The neighbouring Victoria Retail Park has available food facilities for workers at Colwick Industrial Estate including Morrisons, McDonalds, Greggs, Costa and Nandos. On completion of the Sainsburys on the site, Colwick Industrial Estate will also have its own food offer.</p> <p>Riverview Park residential area is immediately adjacent to west of the site with additional residential dwellings to the north of Private Road No7 and No8.</p> <p>There are multiple bus stops positioned along Private road N03 with regular services to Victoria Retail Park, Gedling and the City Centre. Netherfield train station is immediately to the north of the site and provides services to Nottingham, Skegness and Liverpool Lime Street.</p> <p>The majority of the site is walkable via pavements (excluding along the eastern section of Private Road No3), there are no bike routes on the site.</p>	<p>Very Good</p>
<p>Compatibility of Adjoining Uses (including amenity impacts experienced by current/future occupiers and neighbouring areas)</p>	<p>To the east of the site, Class E units border Riverview Park Residential Area; similarly, the units along Private Road NO 8 back onto residential gardens.</p> <p>The River Trent also flows along the south of the site.</p>	<p>Average</p>
<p>Developmental and Environmental Constraints (e.g. size; topography; site access; roads, lighting, landscaping, mains utilities and communications infrastructure; flood risk; contamination; nature and heritage conservation)</p>	<p>Part of the site is subject to a 'Hazardous Substances' designation (Policy LPD 9). The designation covers the vacant Total Reception Building and tarmacked land; Jewsons down Private Road No 2; the units along Private Road No 7; and a portion of the undeveloped land on Private Road No 3.</p>	<p>Average</p>

	<p>The vast majority of the site is currently built out for industrial/commercial uses that are unhindered by this designation however.</p> <p>A review of Flood Maps for Planning (Gov.uk, 2021) shows the site is located within a Flood Zone 3, but is an area benefiting from flood defences. The defences run along the entire length of the southern boundary. Parts of the site however are known to have experienced previous flooding (Gedling Borough Council).</p>	
<p>Barriers to Delivery and Mitigation (including ownership constraints - if known)</p>	<p>Any works conducted on the 'Hazardous Substances' designation would require remediation. Remediation may also be required on other vacant brownfield sites.</p>	<p>Poor</p>
<p>Market Attractiveness (including appropriateness, vacancy and market activity on site for the type of development proposed)</p>	<p>General industrial uses would complement the existing activities along Private Road No3 to the east, an area particularly good for bad neighbour and niche uses.</p> <p>The estate has a notable number of vacancies (between 10-15%) advertised with approximately 13 sites on the market for freehold and leasehold agreements. There are diverse number of commercial agents marketing the vacant sites, including both local and national names such as Savills, Auction Estates, Innes England, NG Chartered Surveyors, Lesley Greaves and FHP.</p> <p>The units and sites available also vary and include;</p> <ul style="list-style-type: none"> • A light industrial unit measuring 5,670 sq ft with a guide price of £140,000 (Auction Estates); • Two Total Sites equating to 4.39 ha, with one of the sites advertised for freehold inviting offers in excess of £1.4million. The sites have been advertised since, at least, the 10 July 2019 (Savills); • Unit 3 (11,250 sq ft), 4A (4,600 sq ft) and 4B (7,250 sq ft) for leasehold with a rent of £65,000 pa, £30,000 pa and £47,125 pa, respectively. These units have been advertised since 25 June 2020 (Innes England) • Suite 3, ground floor (132 sq ft) office accommodation ideal for start-up or small businesses for leasehold with a rent of £2,400 pa (inclusive of utilities, common area cleaning and landlords legal costs). The accommodation has been advertised since 	<p>Average</p>

	<p>19 September 2020 (NG Chartered Surveyors);</p> <ul style="list-style-type: none"> Newly Refurbished industrial units with offices; Unit 1 (3,696 sq ft, warehouse and 450 sq ft, office), Unit 2 (4,202 sq ft, warehouse and 1,280 sq ft, office) and Unit 3 (3929 sq ft, warehouse and 970 sq ft, office) with a leasehold of £101,700 pa (NG Chartered Surveyors) (within Colwick Business Park). <p>Savills describes their freehold site as a rare opportunity with strong development potential, Victor Ktori (Head of Office at Savills Nottingham) comments that “There continues to be significant appetite for development land in Nottingham... The Total Sites are incredibly rare and for this reason we expect there to be considerable interest in Colwick Industrial Estate as a result,” (Savills, 2019)Recent planning activity in relation to the approval of the Sainsbury’s store and B1 / B2 / B8 employment uses on the vacant area of land east along Private Road No 3 does indicate class E interest in this location.</p>	
<p>Strategic Fit with Growth Area Objectives (by target Market Segment)</p>	<p>The following industrial growth sectors are already located within the site:</p> <ul style="list-style-type: none"> Construction Retail <p>The site is also located just outside the ‘Regional Centre’ of Nottingham (as identified in D2N2 Vision 2030 document).</p>	<p>Good</p>
<p>OVERALL SITE RATING</p>	<p>Average</p>	
<p>Recommendation and Potential Future Uses</p>	<p>Allocate for employment (i.e. retain current Local Plan Part 2 Designation (Policy LPD 44) for employment uses)</p> <p>As a consequence, the site should continue to be safeguarded for its current employment uses, utilise the vacant premises with the provision of medium industrial units in conjunction with the refurbishment of rundown buildings and improvements to the road itself running east of Private Road No3.</p> <p>Further work should be undertaken in concert with the land owners/agents in an attempt to understand why available plots on the site have not come forward for employment use (in particular the two Total sites, advertised with Savills), and what could be done to ensure that they are viable, alongside more general environmental improvements to the estate more generally.</p>	

	<p>The site in particular could capitalise on providing business activities that can complement bad neighbour uses to the east.</p>
--	---

SITE SUMMARY:

Currently one of the largest industrial estates in Greater Nottingham and as a consequence is allocated for the retention of employment and employment uses. It is recommended to allocate the site for employment use (i.e. retain current Local Plan Part 2 designation (Policy LPD 44) for employment uses), with the Council working together with site promoters to enhance the estate still further and bring forward vacant plots for development in a timely fashion.

The site is broadly divided into 3 areas and has a number of vacancies (approximately 3 vacant plots with a limited number of disused units and a notable quantity of units, some with office facilities), with the predominant of occupiers along the east of Private Road No3 as heavy industry and bad neighbour uses such as ENVA waste. The site has an active planning history with the vacant parcel of land running east of Private Road No3 approved for a Sainsbury's store and new industrial units.

Victoria Business Park (Ref: GBC4)



GROSS SITE AREA:
27.68 ha

ESTIMATED NET DEVELOPABLE AREA:
1.1 ha

CRITERIA	COMMENT	RATING
<p>Site Context</p> <ul style="list-style-type: none"> • Location with regards to existing employment areas and other sites • How the site fits into the overall portfolio 	<p>Access to the site is from Colwick Loop Road (A612) which runs along the north-west border, a railway also immediately borders the site along its southern border. Beyond the railway line to the south is Colwick Industrial Estate. Netherfield train station is located c.1.5km to the west of the site.</p> <p>The site is favourably identified for the retention of employment and employment uses (Policy LDP 44). The site is also in close proximity to Colwick Industrial Estate.</p>	
<p>Local Plan Designation</p>	<p>The site is allocated in the 'Local Planning Document Part 2 Local Plan' (adopted July 2018) as a site for the retention of employment and employment uses (Policy LPD 44).</p> <p>Other designations include:</p> <ul style="list-style-type: none"> • Local Wildlife Site (Policy LPD 18), marginally encroaches into the east of the site. 	
<p>Status in SHLAA</p>	<p>N/A</p>	
<p>Planning History</p>	<p>No relevant planning history on-site.</p>	
<p>Current Use and Land Type</p>	<p>The site contains Class E and B8 uses. The buildings are in good condition. Sports Direct in particular is a modern/newly built unit. The majority of the site (c.50%) is occupied by BCA Nottingham (car auction) with a substantial area for car parking. The retail park adjacent contains Morrisons, Marks & Spencer, Halfords, Argos, B&Q, McDonald's etc. The rear of the retail park backs onto Victoria Business Park.</p>	

<p>Occupier Profile (if partly developed, including % of available land and levels of vacancy onsite)</p>	<p>Occupiers include BCA Nottingham, Findel education (Logistics Centre Unit), Parcelforce Worldwide, TeamSport Go Karting Nottingham, Whittingtons, Friars Pride Ltd. (food preparation), European Conveyor Systems, CEMA, Sports Direct and Flexopack.</p>	Average
<p>Strategic Road Access</p>	<p>Adjoins Colwick Loop Road (A612).</p>	Average
<p>Local Road Access</p>	<p>Access is via Victoria Park Way, running in an east-west trajectory through Victoria Retail Park.</p>	Very Good
<p>Proximity to Urban Areas and Access to Labour and Services (including public transport / cycling / walking accessibility)</p>	<p>The entire site is walkable with a bus stop immediately on entry to the site providing services to the City Centre. Residential areas are located c.1.5 km to the west of the site with a 5.6 ha residential development being constructed c.0.5 km to the north-east of the site.</p> <p>Carlton Railway Station is also located c.1,2km to the west of the site within services to Matlock and Newark Castle.</p>	Very Good
<p>Compatibility of Adjoining Uses (including amenity impacts experienced by current/future occupiers and neighbouring areas)</p>	<p>Victoria Retail Park adjacent provides a competitive retail offer. Residential to the north, although there is a landscape/road buffer between.</p> <p>The site also neighbours a Local Wildlife Site (Policy LPD 18), to the south east of the site.</p>	Good / Average
<p>Developmental and Environmental Constraints (e.g. size; topography; site access; roads, lighting, landscaping, mains utilities and communications infrastructure; flood risk; contamination; nature and heritage conservation)</p>	<p>There are no obvious constraints except a Local Wildlife Site designation (Policy LPD 18), marginally encroaching into the east of the site. This is connected to the Park via a Public Footpath.</p> <p>A review of Flood Maps for Planning (Gov.uk, 2021) shows the site is located within a Flood Zone 3.</p>	Poor
<p>Barriers to Delivery and Mitigation (including ownership constraints - if known)</p>	<p>The site is fully developed apart from two small patches of land (car park with storage units, c.012 ha and a railway siding measuring c.098ha).</p>	Very Good
<p>Market Attractiveness (including appropriateness, vacancy and market activity on site for the type of development proposed)</p>	<p>A single unit (Unit 4) along Pintail Road is vacant. A plot of land within the central area is currently used for car parking with two storage units (c.0.12 ha). A railway siding is also positioned to the east</p>	Good

	of the site, some disused railway carriages are parked within the siding. The area of land measures approximately 0.98ha.	
Strategic Fit with Growth Area Objectives (by target Market Segment)	<p>The following industrial growth sectors are already located within the site;</p> <ul style="list-style-type: none"> • Food and drink manufacturing • Visitor Economy • Logistics and E-commerce • Retail • Professional/Business Service <p>The site is also located just outside the “Regional Centre” of Nottingham (as identified in D2N2 Vision 2030 document).</p>	Good
OVERALL SITE RATING	Good	
Recommendation and Potential Future Uses	<p>Allocate for employment (i.e. retain current Local Plan Part 2 designation (Policy LPD 44) for employment uses)</p> <p>There is some potential to intensify the development of the site by utilising car parking/storage land on the eastern part of the site and the redevelopment of the railway siding.</p>	
SITE SUMMARY:		
<p>The current Business Park has a mix of occupiers within the class E use and a B8 Parcelforce Worldwide distribution unit. There are very few vacancies on the site; however, a railway siding and undeveloped land used for car parking / storage within the site has potential for redevelopment. The site should therefore be allocated for employment (i.e. retain current Local Plan Part 2 designation (Policy LPD 44) for employment uses).</p>		

Salop Street (Ref: GBC5)



GROSS SITE AREA:
2.48 ha

ESTIMATED NET DEVELOPABLE AREA:
0 ha

CRITERIA	COMMENT	RATING
<p>Site Context</p> <ul style="list-style-type: none"> • Location with regards to existing employment areas and other sites • How the site fits into the overall portfolio 	<p>The site adjoins the B6004 to the north and the A60 (Mansfield Road) to the east, within the town of Arnold. Across the B6004 to the north is Lidl, to the north and west is Arnbrook Primary School and residential development. To the west of the site is a substantial residential area, with the Premier Inn immediately to the south and Aldi beyond. Past the A60 to the south-east is Nottinghamshire County Council Offices, a Sainsbury's supermarket with petrol facilities, McDonald's and the Royal Mail Delivery Office.</p> <p>The site is favourably identified for the retention of employment and employment uses in the Local Plan (Policy LDP 44); the site is also within the town of Arnold in close proximity to other retail sites, Grade II Listed Former Homes Ales Brewery Office (currently occupied by Nottinghamshire County Council) and the Royal Mail Delivery Office.</p>	
<p>Local Plan Designation</p>	<p>The site is allocated in the '<i>Local Planning Document Part 2 Local Plan</i>' (adopted July 2018) as a site for the retention of employment and employment uses (Policy LPD 44).</p> <p>Other designations include:</p> <ul style="list-style-type: none"> • Protected Open Space (Policy LPD 20), marginally allocated within the south of the site. 	
<p>Status in SHLAA</p>	<p>N/A</p>	
<p>Planning History</p>	<p>No relevant planning history on-site.</p>	
<p>Current Use and Land Type</p>	<p>A mixed-use site with Class E and Sui Generis businesses. The buildings are of mixed ages dating from the 90s (some</p>	

	with more modern facades) to a refurbished VW car dealership. The buildings are in reasonably good condition with no vacant premises evident.	
Occupier Profile (if partly developed, including % of available land and levels of vacancy onsite)	Occupiers of the site include Big City Print (printers), ERF Electrical, Mirabel Home Improvement Shop, The Coolex Group (air conditioning), Volkswagen Dealership (expanding c. 30% of the site) and just outside the site's boundary on Salop Street, Daybrook Medical Practice with Rowlands Pharmacy.	
Strategic Road Access	Adjoins the B6004 and A60 Mansfield Road.	Average
Local Road Access	Salop Street, B6004 and A60 Mansfield Road.	Very Good
Proximity to Urban Areas and Access to Labour and Services (including public transport / cycling / walking accessibility)	The site neighbours residential areas to the north, east and west. A bus stop is immediately adjacent ERF Electrical on the A60 with buses to Worksop/Retford, New Ollerton and Nottingham. The buildings are clustered around a central car park with good pedestrian pavements around the site. A short walkway extends west off Salop Street towards the residential area and park.	Very Good
Compatibility of Adjoining Uses (including amenity impacts experienced by current/future occupiers and neighbouring areas)	Neighbours are predominately residential, with a hotel and retailing area in the immediate vicinity.	Average
Developmental and Environmental Constraints (e.g. size; topography; site access; roads, lighting, landscaping, mains utilities and communications infrastructure; flood risk; contamination; nature and heritage conservation)	There are no obvious developmental and environmental constraints. A review of Flood Maps for Planning (Gov.uk, 2021) shows the site is not located within a Flood Zone.	Very Good
Barriers to Delivery and Mitigation (including ownership constraints - if known)	The site is fully developed with no obvious barriers noted from the site visit.	Very Good
Market Attractiveness (including appropriateness, vacancy and market activity on site for the type of development proposed)	There are no vacant units on site with no available land for development opportunities. The site is in a high-profile location with customers on the immediate door step and within walking distance of other retail providers.	Good

Strategic Fit with Growth Area Objectives (by target Market Segment)	The following industrial growth sectors are already located within the site: <ul style="list-style-type: none"> • Retail • Creative and Digital The site is also located just outside the “Regional Centre” of Nottingham (as identified in D2N2 Vision 2030 Document)	Average
OVERALL SITE RATING	Average / Good	
Recommendation and Potential Future Uses	Protect for employment (i.e. retain current Local Plan Part 2 designation (Policy LPD 44) for employment uses) Safeguard the site for its current employment uses.	
SITE SUMMARY:		
The site currently is used for mixed-use businesses, with a Sui Generis VW car dealership the largest occupier of the site. The site has a favourable location within immediate proximity of residential areas and retail units. The site is also well served by public transport with a bus stop on the A60. The site should therefore be protected for employment (i.e. retain current Local Plan Part 2 designation (Policy LPD 44) for employment uses).		

Brookfield Road (Ref: GBC6)



**GROSS SITE AREA:
4.38 ha**

**ESTIMATED NET DEVELOPABLE
AREA:
0 ha**

CRITERIA	COMMENT	RATING
<p>Site Context</p> <ul style="list-style-type: none"> • Location with regards to existing employment areas and other sites • How the site fits into the overall portfolio 	<p>The site is located within the town of Arnold and is bound by residential dwellings on all sides, except for the eastern side (although this is allocated for 140 dwellings (SHLAA ref. 6/18). Beyond the southern boundary, along Rolleston Drive is a short shopping frontage containing predominately independent hospitality venues and a Premier Convenience store.</p> <p>The site is identified for the retention of employment and employment uses (Policy LDP 44). The site is constrained by local road access.</p>	
<p>Local Plan Designation</p>	<p>The site is allocated in the 'Local Planning Document Part 2 Local Plan' (adopted July 2018) as a site for the retention of employment and employment uses (Policy LDP 44).</p>	
<p>Status in SHLAA</p>	<p>N/A</p>	
<p>Planning History</p>	<p>No relevant planning history on-site.</p>	
<p>Current Use and Land Type</p>	<p>An industrial estate comprising of Class E and B2 Uses.</p>	
<p>Occupier Profile (if partly developed, including % of available land and levels of vacancy onsite)</p>	<p>Occupiers of the site include: Academe Roofing, Arrow Specialised Transport Ltd, Autohouse R&K, St. Ann's Sheet Metal, Turners Cars, Howdens, John Lewis (offices) and Leivers (Fresh Food Specialists). The buildings are of an average quality, dating from c. the mid-late 1990s.</p> <p>The central area of the site is occupied by Biz Space (Arnold Business Centre) – a period building in good condition. The Business Centre contains approximately 20 units occupied</p>	

	<p>by Wentworth Sporting Supplies, Austins Carpets, Bluedge Motorcycles, Yummy Little Cakes, Phillips Garner Furniture, A Archer Electrical, Gunchips Engineering, Craft Source, PLM Global Brookfield Bodyworks and Arnold Garage,</p> <p>The latter business is currently progressing with a minor extension to the front elevation.</p> <p>The Business Centre itself has a single unit that is vacant.</p>	
Strategic Road Access	The site is accessed from local roads via Rolleston Drive to the south-east or Hallam's Lane/Gedling Road to the north-west.	Very Poor
Local Road Access	Brookfield Road enters the site to the north east and envelopes the site. The road travels through dense residential areas.	Poor
Proximity to Urban Areas and Access to Labour and Services (including public transport / cycling / walking accessibility)	<p>A bus stop is located on Brookfield Road; however, the stop is currently not in use. The nearest active bus stops are located just north of the site on Rolleston Drive with services to Killisick and Nottingham City</p> <p>The site has footpath access throughout with parking facilities. The site is encompassed by residential areas to the north, west and south. Arnold View Primary School is 0.45km to the west.</p>	Very Good
Compatibility of Adjoining Uses (including amenity impacts experienced by current/future occupiers and neighbouring areas)	Surrounded by residential areas on 3 sides.	Very Poor
Developmental and Environmental Constraints (e.g. size; topography; site access; roads, lighting, landscaping, mains utilities and communications infrastructure; flood risk; contamination; nature and heritage conservation)	<p>The location of the site is constrained by local roads and surrounding residential areas. There is no vacant land within the site and Historic England's Mapping Tool (2021) identifies a Grade II Listed Building on the site (Former Allen Solly Factory).</p> <p>A review of Flood Maps for Planning (Gov.uk, 2021) shows the site is not located within a Flood Zone.</p>	Poor
Barriers to Delivery and Mitigation (including ownership constraints - if known)	The site is fully developed and no barriers to delivery were identified from the site visit.	Very Good
Market Attractiveness (including appropriateness, vacancy)		Good

and market activity on site for the type of development proposed)	A single unit is vacant on the site, there are no agent marketing signs on display. Appears to be well occupied and a popular estate.	
Strategic Fit with Growth Area Objectives (by target Market Segment)	<p>The following industrial growth sectors are already located within the site;</p> <ul style="list-style-type: none"> • Food and Drink Manufacturing • Retail <p>The site is also located just outside the “Regional Centre” of Nottingham (as identified in D2N2 Vision 2030 Document).</p>	Average
OVERALL SITE RATING	Average	
Recommendation and Potential Future Uses	<p>Protect for employment (i.e. retain current Local Plan Part 2 Designation (Policy LPD 44) for employment uses)</p> <p>Safeguard the site for its current employment uses. The site has limited opportunity for redevelopment and expansion and any potential future uses must respect the sensitive residential occupants adjacent. The site has very few vacancies and is a popular local employment site.</p>	
SITE SUMMARY:		
<p>The industrial estate contains a mix of Class E and B2 uses, the site is constrained by local roads and residential neighbours. The site is nearly fully occupied with very few vacancies and one business is extending its operational footprint. The site should therefore be protected for employment (i.e. retain current Local Plan Part 2 designation (Policy LPD 44) for employment uses).</p>		

Teal Close (Ref: GBC7)



**GROSS SITE AREA:
8.60 ha**

**ESTIMATED NET DEVELOPABLE AREA:
6.45 ha
(75% adjustment due to business park with
high landscape quality)**

CRITERIA

COMMENT

RATING

Site Context

- Location with regards to existing employment areas and other sites
- How the site fits into the overall portfolio

The site is located towards the eastern edge of the village of Carlton, 2.25 km from Carlton Rail Station. Gedling itself is 2.6 km to the east, an approximately 7-minute drive. The site is also positioned just north of Victoria Business Park and Colwick Industrial Estate.

Teal Park is a 155-acre mixed use development comprising 830 new houses, trade counter and employment units, local centre, care home, school and sports pitches.

The residential element is currently under construction to the south of the site along Magenta Way. To the west of the site is agricultural land and Severn Trent Sewage Treatment Plant to the north.

Within its spatial context the site forms part of a wider employment area and is a sustainable urban extension given its current and potential transport connectivity.

Local Plan Designation

The site is allocated in the 'Aligned Core Strategy Part 1 Local Plan' and the 'Aligned Core Strategy Policies Map' (adopted 2014) as a Strategic Allocation (Policy 2: The Spatial Strategy).

Other designations include:

- Policy 4: Employment Provision and Economic Development

Status in SHLAA

Reference; 6/782 (830 dwellings)

Planning History

Recent planning history includes;

	<ul style="list-style-type: none"> • 2013/0546 – Outline planning application comprising residential development (up to 830 units), employment uses (up to 18,000 square metres, Use Classes B1/B2/B8, a community hub (Use Classes A1-A5 and D1), primary school, hotel (Use Class C1), care homes (Use Class C2), playing pitches and changing facilities, public open space, allotments, structural landscaping, access arrangements and an ecology park, and demolition of existing structures – Approved 30 Jun 2014 • 2017/0800 – Reserved Matters Application for the erection of 199 dwellings (C3), including 10 affordable units, and the associated infrastructure including landscaping, community uses/changing rooms (D2), playing pitches, a NEAP and public open space and an ecological park (including a phasing schedule for B1-B8 Use) – Approved 02 Mar 2018 • 2019/0614 – Reserved Matters Application in relation to appearance, landscaping, layout and scale of the trade park and unit 1 of the employment area pursuant to outline planning permission 2017/0999 – Approved 08 Nov 2019. • 2019/0615 – Reserved Matters Application in relation to appearance, landscaping, layout and scale for the development of the employment area (6no. employment units) pursuant to outline planning permission 2017/0999 – Decision Pending. 	
Current Use and Land Type	The site is currently used for agricultural land, with 3-4 storage containers placed on its eastern edge.	
Occupier Profile (if partly developed, including % of available land and levels of vacancy onsite)	N/A – Undeveloped Land with reserved matters applications for the erection of B1-B8 use units (ref. 2017/0800; 2019/0615).	
Strategic Road Access	Adjoins the Colwick Loop Road (A612)	Average
Local Road Access	Access to the site is from Stoke Lane. Stoke Lane connects to Colwick Loop Road via a signalised junction.	Very Good
Proximity to Urban Areas and Access to Labour and Services (including public transport / cycling / walking accessibility)	<p>At present there is no public transport facilities servicing the site.</p> <p>The nearest bus stops are located on Emerys Road (approximately 0.80km to the east of the site), accessible within walking distance via a footpath adjacent the southern boundary of the allotments on Stoke Lane. The stops provide services to Netherfield and Burton Joyce. To further enhance the accessibility of the site by bus, a number of discussions have taken place between public transport operators and Nottinghamshire County</p>	

	<p>Council to better services to the site (Transport Assessment, ref. 2013/0546).</p> <p>The site is also within a 2km catchment radius of the district centres of Netherfield, Gedling and Carlton. These locations have local facilities such as banks, hairdressers, pubs and a wide range of retail and leisure facilities. Access to all three centres is good with high quality pedestrian infrastructure in place for large segments of the routes (Planning Statement, Chapter 8, ref. 2013/0546).</p> <p>There is existing cycle infrastructure in the immediate surroundings of the site with a shared footway/cycle way on the A612 providing cycle connectivity between the site and the wider area. The internal layout of the site is yet to be approved in detail within the forthcoming reserved matters applications. However, the site layout plan, as part of application 2019/0615, shows the provision of car parking spaces and cycle stores. The approved Transport Assessment accompanying application 2013/0546 details the site will incorporate combined footpaths and cycle ways on both sides of the carriageways.</p>	
<p>Compatibility of Adjoining Uses (including amenity impacts experienced by current/future occupiers and neighbouring areas)</p>	<p>Following Colwick Loop Road to the south, the site forms part of a larger employment area including Victoria Business and Retail Park and Colwick Industrial Estate. On completion of the residential area to the south, any new units would adjoin this sensitive location although there is a substantial buffer.</p>	Average
<p>Developmental and Environmental Constraints (e.g. size; topography; site access; roads, lighting, landscaping, mains utilities and communications infrastructure; flood risk; contamination; nature and heritage conservation)</p>	<p>The site appears to have limited physical constraints, despite a slight mound of soil adjacent Stoke Lane. As agricultural fields the site is flat and regular in shape.</p> <p>A review of Flood Maps for Planning (Gov.uk, 2021) shows the site is located within a Flood Zone 2/Flood Zone 3 but is an area benefiting from flood defences.</p>	Good
<p>Barriers to Delivery and Mitigation (including ownership constraints - if known)</p>	<p>Due to its current use, the site has limited lighting and mains utilities however the infrastructure is forthcoming as part of the development (ref. 2013/0546).</p>	Very Good (on completion)
<p>Market Attractiveness (including appropriateness, vacancy and market activity on site for the type of development proposed)</p>	<p>There are 14 units advertised to let from the property agent Phillip Sutton and FHP. The Units have been advertised on the agent's website for the past 6 months.</p>	Very Good

	<p>The marketing brochures advertise new industrial warehouse and trade counter units from 2,000 to 70,000 sq. ft. with 5% office content.</p> <p>All units are advertised for sale or to let with the specification detailing all units to be constructed of a steel portal frame with clad and glazed elevations containing 10% roof lights. The units have onsite car parking with concrete surfaced loading yards. Phillip Sutton do not detail the cost of the units.</p>	
Strategic Fit with Growth Area Objectives (by target Market Segment)	<p>The following D2N2 industrial growth sectors have potential to be accommodated within the site following development of the above units;</p> <ul style="list-style-type: none"> • Creative & Digital • Logistics & E-commerce • Construction <p>The site is also located just outside the 'Regional centre' of Nottingham (as identified in D2N2 Vision 2030 document).</p>	Good
OVERALL SITE RATING	Very Good	
Recommendation and Potential Future Uses	<p>Designate for mixed-use with element of employment use (i.e. retain current strategic allocation for employment uses)</p> <p>The site is currently allocated within the Local Plan Part 1 as a Strategic Allocation (Policy 2: The Spatial Strategy), with the underlying rational of the policy to ensure sustainable development as part of the plan area through urban concentration with regeneration. With the reserved matters applications for the development of 7 employment units within the site submitted the site should be retained for employment use.</p>	
SITE SUMMARY:		
<p>The site is currently used as agricultural land and designated in the adopted Local Plan Part 1 as a Strategic Location (Policy 2: The Spatial Strategy). The site is coming forward as a mixed-use residential led development as part of application ref. 2013/0546, the subsequent reserved matters applications in relation to the employment units (6 of the planned 14) are pending a decision with Unit 1 of the employment area (including appearance, landscaping, layout and scale of the trade park) approved on the 8 November 2019 ref. 2019/0614. It is therefore recommended for designated for mixed-use with an element of employment use (i.e. retain current strategic allocation for employment uses).</p>		

	<p>'Urban Fringe Environmental Area' and is also vaguely located adjacent the 'Green Infrastructure Corridor'.</p> <ul style="list-style-type: none"> • Policy LPD 16: Safeguarded Land, land to the north of the strategic allocation have been removed from the Green Belt and designated as Safeguarded Land. 	
Status in SHLAA	References: 6/1160; 6/989; 6/467	
Planning History	<p>Recent planning history includes;</p> <ul style="list-style-type: none"> • 2020/0050 – Outline planning application for mixed-use development comprising; 805 homes, land for employment purposes (up to 49,500 sqm of B1/B8 uses) a Local Centre comprising A1-A5, B1 (a) and D1 uses (up to 2,800m²), a 1.5 form entre Primary School and associated infrastructure, open space – Decision Pending. • 2008/0595 – Full planning application for Construction of a new access off Annesley Road (A611) (Junction 2) • 2008/0594 – Full planning application for Construction of a new access off Annesley Road (A611) (Junction 1). 	
Current Use and Land Type	The site was greenfield land in agricultural use, a new access from the A611 and spine road is under construction and the site now includes a construction compound of temporary buildings.	
Occupier Profile (if partly developed, including % of available land and levels of vacancy onsite)	N/A	
Strategic Road Access	Adjoins the A611 (Annesley Road). The site is c. 6km from the M1.	Average
Local Road Access	A new access from the Wighay Road/Annesley Road A611 roundabout was under construction and an additional access from the A611 further north of this is proposed under the pending planning application (ref. 2020/0050).	Very Good
Proximity to Urban Areas and Access to Labour and Services (including public transport / cycling / walking accessibility)	The site is on the northern periphery of Hucknall. The nearest bus stops are approximately 300m south of the site on Annesley Road with regular services to Hucknall, Nottingham, Mansfield and Sutton in Ashfield. The site is approximately 2.5km from the centre of Hucknall and Hucknall Railway Station.	Average / Good
Compatibility of Adjoining Uses (including amenity impacts experienced by current/future occupiers and neighbouring areas)	The site is bound to the north by greenfield land in agricultural use, to the east by a farm track with further agricultural land beyond, to the south and west by Annesley Road A611.	Good

Developmental and Environmental Constraints (e.g. size; topography; site access; roads, lighting, landscaping, mains utilities and communications infrastructure; flood risk; contamination; nature and heritage conservation)	This is a level site with significant frontage onto the Hucknall bypass and access directly from this. It is on the northern periphery of Hucknall and is easily accessible by a range of transport modes. The site is within flood zone 1 and therefore at low risk of flooding. There are no statutory designations or historical assets within or adjacent to the site.	Very Good
Barriers to Delivery and Mitigation (including ownership constraints - if known)	A planning application (ref. 2020/0050) for development of the site is pending determination.	Very Good
Market Attractiveness (including appropriateness, vacancy and market activity on site for the type of development proposed)	This site is on the outskirts of Hucknall and has significant frontage onto and access from the Hucknall bypass. The SUE planning application pending determination includes land for B1/B8 employment uses (up to 49,500 sqm) fronting the A611.	Good
Strategic Fit with Growth Area Objectives (by target Market Segment)	The site has the potential to accommodate key growth sectors including business and professional services as well as manufacturing and logistics.	Good
OVERALL SITE RATING	Good	
Recommendation and Potential Future Uses	Designate for mixed-use with element of employment use (i.e. retain current strategic allocation with a substantial element of E/B8 employment land)	
SITE SUMMARY:		
<p>The site is allocated as a Strategic Allocation in the 'Greater Nottingham Aligned Core Strategy Part 1 Local Plan' and forms part of a 35.6ha Sustainable Urban Extension. An outline planning application for development of the site is pending determination. The proposals comprise: 805 homes, land for employment purposes (up to 49,500 sqm of B1/B8 uses) a Local Centre comprising A1-A5, B1 (a) and D1 uses (up to 2,800m²), a 1.5 form entre Primary School and associated infrastructure and open space.</p> <p>The site is located on the northern periphery of Hucknall town and is easily accessed via a range of transport modes. It has significant frontage onto the A611 Hucknall bypass and would be an attractive location for a range of employment uses. It is recommended to designate the site for mixed-use with element of employment use (i.e. retain current strategic allocation with a substantial element of E/B8 employment land).</p>		

Old Mill Lane Industrial Estate (Ref: MDC1)

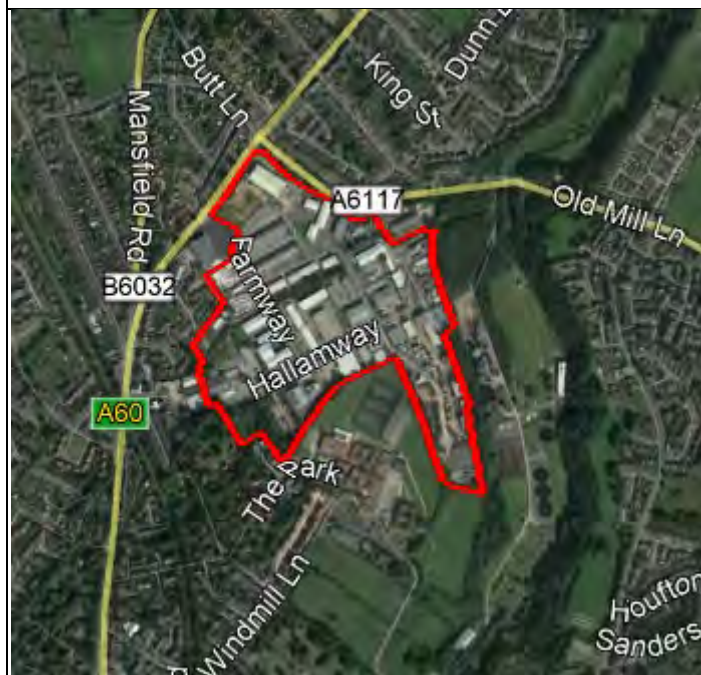

GROSS SITE AREA:
20.03 ha

ESTIMATED NET DEVELOPABLE AREA:
0 ha

CRITERIA	COMMENT	RATING
<p>Site Context</p> <ul style="list-style-type: none"> • Location with regards to existing employment areas and other sites • How the site fits into the overall portfolio 	<p>This is a successful and popular industrial estate on the northern periphery of Mansfield. The employment uses have been diluted by a range of other uses including a supermarket, bakery, leisure uses and a range of homewares/DIY shops.</p> <p>It is located 2.5 km west of the Crown Farm Way Industrial Estate, 1.6 km south of the Grove Way, Mansfield Woodhouse employment area, 3 km east of the Millennium Business Park and 2 km north of the Broadway Industrial Estate.</p>	
<p>Local Plan Designation</p>	<p>The Development Plan for Mansfield comprises of the Mansfield District Local Plan 2013-2033 (Adopted September 2020). The site is designated as a Key / General Employment Area (Policy E3a).</p>	
<p>Status in SHLAA</p>	<p>The Housing and Economic Land Availability Assessment (HELAA) (2017) identified a number of smaller areas within the site as follows:</p> <ul style="list-style-type: none"> • Site ref. 121 – Rippon Homes Building – 0.66ha – Excluded at Stage 2. This is now occupied by a new Lidl supermarket. • Site ref. 200 – Land to the rear of Grove Motors Units 1-2 Hallamway – 0.12 ha – Permission Granted, Reasonable Alternative. This is now occupied by Millwood Timber. • Site ref. 213 – Land between Hallamway and Units 1-3 Old Mill Lane – 1 ha – Permission Granted, Reasonable Alternative. This is now occupied by Screwfix, Greggs, Bubbles Bathrooms, ERF Electrical Wholesaler and a Volvo car service centre. 	

<p>Planning History</p>	<p>Recent planning history includes:</p> <ul style="list-style-type: none"> • 2020/0083/FUL – Full planning application – First Floor Extension to Offices – Granted 31.03.2020 • 2019/0716/NMA – Non-material amendment – Non-material amendment to Condition 7 on Planning – Application 2018/0702/FUL to delete words ‘And Bank Holiday’ from the Condition wording – Granted 19.11.2019 • 2018/0684/ADV – Advertisement Consent – Signage in the form of 2 No. Double Sided Externally illuminated totems – Granted 12.12.2018 • 2018/0702/FUL – Full planning application – Proposed retail supermarket with associated access, car parking and servicing – Granted 18.10.2019 • 2018/0820/FUL – Full planning application – Single Storey Extension for Office Use and Showroom – Granted 07.02.2019 • 2017/0598/PNSDM – Demolition of the former Rippons Homes Building, associated commercial unit and 2 No. Residential properties, and associated works – Granted 17.10.2017 • 2017/0066/FUL – Full planning application – Construction of 3 No. Industrial Units with B2 use, including vehicle access – Granted 23.03.2017 • 2017/0782/FUL – Full planning application – Single Storey Extension including warehouse extension, plant store and associated works – Granted 17.01.2018 • 2016/0137/NT – Full planning application - Creation of 3 No. New Trade Units Comprising 1 No. For B8 Use with Trade Counter, 2 No. For A1 (Convenience/Food A5, B1 and B8, and associated pick up point and car parking on existing industrial estate. Relocation of the existing site entrance to a new site entrance – Refused 17.03.2017 • 2016/0611/NT – Change of use – Change of use application - Change of use from A1 (Shops) to Use Class D2 (Assembly and Leisure) – Granted 20.12.2016 • 2016/0320/NT – Full planning application - Proposed extension – Granted 29.09.2016
<p>Current Use and Land Type</p>	<p>This is a brownfield site occupied by an industrial estate.</p>
<p>Occupier Profile (if partly developed, including % of available land and levels of vacancy onsite)</p>	<p>This site is fully developed and occupied by a mix of uses including a Lidl supermarket, i-Jump Trampoline Park, Greggs bakery, Angels Gym, a pet supplies store, a caravan dealer and a charity.</p> <p>There is a substantial number of homewares and DIY shops on the site including United Carpets and Beds, Bubbles Bathrooms, Screwfix, Appliance People, Kitchen World, Howdens Joinery, Jewson Building Supplies and Millwood Timber.</p>

	<p>There are a number of B2/B8 units occupied by a range of uses including tool manufacturers, metal fabricators, welders and commercial printers.</p> <p>Other occupiers include a Royal Mail delivery office and a waste management company, as well as a number of vehicle MOT and repair centres.</p> <p>At the time of the site visit (December 2020) all units appeared to be occupied with only Unit 6 Block 5 adjacent to Greggs comprising of a retail pod of 125.42 sqm currently under offer.</p> <p>Areas of the estate are in poor condition.</p>	
Strategic Road Access	The A60 adjoins the site's western boundary and the A6117 adjoins the site's northern boundary. Junction 28 of the M1 is approx. 13.5km from the site and is accessed via the A60 and A38.	Average
Local Road Access	The site can be accessed via the A6117 (Old Mill Lane) which is a good free-moving, largely residential road which heads South-West and adjoins the B6030 after 1.6km and the A6191 after 4km. From the site, the A60 is accessed via the A6117 to the North. The A60 heads North (Leeming Lane) towards Mansfield Woodhouse and South (Woodhouse Road) towards the centre of Mansfield. The units adjacent to the A60 have direct access from it.	Good
Proximity to Urban Areas and Access to Labour and Services (including public transport / cycling / walking accessibility)	<p>The site is approximately 2.2km North East of Mansfield town centre and approximately 1.6km South of Mansfield Woodhouse (part of the Mansfield Urban Area). The area provides a wide range of facilities and services including schools, medical services and shops. Mansfield also provides a range of recreational facilities and a police station.</p> <p>The A60 adjacent to the site is serviced by bus stops with regular services traveling North towards Shirebrook and Meden Vale and South towards Mansfield and Mansfield train station. Mansfield Woodhouse train station is not accessible from the site by public transport but is under a 2 km walk.</p>	Good / Very Good
Compatibility of Adjoining Uses (including amenity impacts experienced by current/future occupiers and neighbouring areas)	The site is bound by the A6117 to the north with residential areas beyond, by the River Maun, woodland and water treatment works to the east, to the south by residential areas and The Brunts Academy school and school fields and to the west by the A60 with residential areas beyond.	Average / Poor
Developmental and Environmental Constraints	This is a large industrial estate with utilities and communications infrastructure in place.	Good

<p>(e.g. size; topography; site access; roads, lighting, landscaping, mains utilities and communications infrastructure; flood risk; contamination; nature and heritage conservation)</p>	<p>The site slopes gently down from the A60 to the west.</p> <p>There is an electricity pylon in the west of the site and overhead lines intersect the site east to west.</p> <p>The site is within Flood Zone 1 and therefore at low risk of flooding.</p> <p>The Maun Valley Park Local Nature Reserve is approximately 175m east of the site.</p> <p>There is a grade II listed building Woodhouse Place (ref. 1251911) within 150m west of the site.</p>	
<p>Barriers to Delivery and Mitigation (including ownership constraints - if known)</p>	<p>The site is fully developed and no other barriers to redevelopment were evident from the site visit.</p>	<p>Very Good</p>
<p>Market Attractiveness (including appropriateness, vacancy and market activity on site for the type of development proposed)</p>	<p>This is a large site within the main urban area of Mansfield with good local road access and access to labour markets and services. Vacancy levels were low at the time of the site visit. Areas of the estate are in poor condition and would benefit from upgrade or renewal to improve the site's kerb appeal.</p>	<p>Average</p>
<p>Strategic Fit with Growth Area Objectives (by target Market Segment)</p>	<p>This site already accommodates key industrial growth sectors as identified in the D2N2 Vision 2030 document including construction and retail. It is located within Mansfield urban area and has potential to accommodate other key industrial growth sectors.</p>	<p>Average</p>
<p>OVERALL SITE RATING</p>	<p>Average</p>	
<p>Recommendation and Potential Future Uses</p>	<p>Protect for employment uses (i.e. retain employment land allocation as a as a key / general employment area).</p>	
<p>SITE SUMMARY:</p>		
<p>This is a successful industrial estate on the northern periphery of Mansfield. The employment uses have been diluted by a range of other uses including a supermarket, bakery, leisure uses and a range of homewares/DIY shops. Areas of the estate are in poor condition and would benefit from upgrade or renewal. However, the site is fully developed and vacancy levels are low. The site provides important local employment space and is designated as a key / general employment area and it is recommended that the site is protected for employment uses.</p>		

Sherwood Oaks Business Park (Ref: MDC2)



**GROSS SITE AREA:
11.45 ha**

**ESTIMATED NET DEVELOPABLE AREA:
3.09 ha**

(Note: Comprising of land to the south of the hospital (Local Plan ref: 1.41 ha) and land south of Oak leaf close (Local Plan ref, area 1.68 ha) excluding the MKM building supplies development)

CRITERIA	COMMENT	RATING
<p>Site Context</p> <ul style="list-style-type: none"> • Location with regards to existing employment areas and other sites • How the site fits into the overall portfolio 	<p>This site comprises of modern detached office buildings, car showrooms, a hospital, a supermarket, a pub/restaurant and a building supplies store. There are a couple of smaller undeveloped areas within the site comprising of land to the south of Oak Leaf Close and land to the south of St Andrew's Healthcare.</p> <p>It is within a wider industrial area along Southwell Road West (A6191) on the south-eastern outskirts of Mansfield. It is adjacent to the Bellamy Road Industrial Estate and the Ratcher Hill employment area, and in close proximity to Oak Tree Business Park and Ransom Wood Business Park.</p>	
<p>Local Plan Designation</p>	<p>The Development Plan for Mansfield comprises of the Mansfield District Local Plan 2013-2033 (Adopted September 2020). The site is designated as a Key / General Employment Area (Policy E3b).</p> <p>Two sites immediately west of Sherwood Avenue are allocated as a housing commitment (Policy H2) and a housing allocation (Policy H1e).</p> <p>Land immediately south of the site and south of Old Newark Road is allocated as a committed strategic urban extension (Policy SUE3).</p>	
<p>Status in SHLAA</p>	<p>The HELAA (2017) identified a few smaller sites within the</p>	

	wider site as 'reasonable alternative' sites (refs. 27c, 41 and 169). However, they are not currently being promoted through the HELAA.
Planning History	<p>Recent planning history includes:</p> <ul style="list-style-type: none"> • 2019/0444/FUL – Full planning application – 21 No. Industrial Units for B1C, B2 and B8 Use in 4 No. Blocks Including Associated External Works with Access to Existing Road – Pending Decision • 2018/0135/FUL – Full planning application – Erect building for use as a builder's merchant – Grant 01.05.2018 • 2013/0376/ST – Full planning application – Erect Two Storey, Self-contained office building – Grant 19.09.2013 <p>An outline application for 169 residential dwellings has been submitted, which borders the employment area to the south and is pending a decision:</p> <ul style="list-style-type: none"> • 2018/0379/OUT – Outline planning application – Outline application for up to 169 no. residential dwellings and means of access, with all other matters reserved. (Resubmission of Planning Application 2018/0379/OUT)
Current Use and Land Type	This is brownfield site occupied by a business park with a mix of uses including employment.
Occupier Profile (if partly developed, including % of available land and levels of vacancy onsite)	<p>The development is modern with an open layout and high-quality purpose-built buildings providing an attractive working environment.</p> <p>The employment uses on the site are somewhat diluted; the site contains car salesrooms, modern offices, a hospital, a restaurant, a supermarket and a building supplies shop. Occupiers include Ford and Skoda car salesrooms, St Andrew's Healthcare (mental health hospital), Bridge Bank (civil engineers), Miller Knight (fire protection service), The Golden Eagle Marston's restaurant, Aldi and MKM Building Supplies.</p> <p>At the time of the site visit (November 2020) there was one office on the market comprising of 288 sqm. However, this is now under offer.</p> <p>There are a few potential development plots on the site as follows:</p> <p>The land to the south of St Andrew's Healthcare comprising of 1.41 ha was vacant at the time of the site visit. It is identified in the HELAA (ref. 27c) as not currently being promoted by the landowner and therefore it is a reasonable alternative site. The site is limited to use class E office development due to adjoining residential uses. An application for employment uses is pending (ref. 2019/0444/FUL).</p>

	<p>The land to the south of the office units off Oak Leaf Close and east of the new Aldi store comprises of 2.67 ha. It includes the new MKM building supplies store (site area 0.7ha). However, the land to the south of Oak Leaf Close was vacant at the time of the site visit. The HELAA identified the site (ref. 41) as a reasonable alternative site and it was not being promoted by the landowner.</p> <p>The land adjacent Unit 3 is within the wider HELAA site ref. 41 discussed above. It is identified in the HELAA as comprising 0.12 ha (ref. 169), it has permission (ref. 2013/0376/ST) and is identified as a reasonable alternative site.</p>	
Strategic Road Access	<p>The site is adjacent to and accessed from Southwell Road West (A6191). The A6191 joins the A617 approximately 500m east of the site. The A6191 continues 3.4 km North West to the A60 and Junction 28 of the M1 is 14.3km away via the A617 and A38.</p>	Average
Local Road Access	<p>The site can be accessed from the A6191 which is a good free-moving road heading North West towards Mansfield and South East towards the B6020 (Mansfield Road) and the A617. The B6020 continues South East towards Rainworth. The A617 continues East towards Newark-on-Trent and West towards Sutton-in-Ashfield.</p> <p>The site's internal spine road Sherwood Avenue branches off from Southwell Road West.</p>	Very Good
Proximity to Urban Areas and Access to Labour and Services (including public transport / cycling / walking accessibility)	<p>The site is located on the south-eastern outskirts of Mansfield. Mansfield town centre provides a wide range of facilities and services including schools, medical services, shops, recreational facilities and a police station.</p> <p>The residential suburb of Berry Hill is located to the west of the site. The site is also to the south of Oak Tree Lane and surrounding residential area, as well as Tesco Extra. The site is located 2km North West of Rainworth village via the A6191 and B6020 which provides schools, a health centre, local shops, post office and takeaway.</p> <p>The site is serviced by regular bus services via stops on the A6191 travelling South East (towards Nottingham and Rainworth, and less frequent services to Newark, Blidworth, Bilsthorpe and Eakring) and North West (towards Mansfield and Sutton in Ashfield). Mansfield railway station is 4.5km away and is serviced by regular bus stops on the A6191.</p>	Average

Compatibility of Adjoining Uses (including amenity impacts experienced by current/future occupiers and neighbouring areas)	The site is bound by the A6191 to the north, Old Newark Road to the east and south (an unsurfaced track road, one-car wide) with fields beyond to the A617, and The Anglia Way/Bellamy Road industrial estates to the west.	Very Good
Developmental and Environmental Constraints (e.g. size; topography; site access; roads, lighting, landscaping, mains utilities and communications infrastructure; flood risk; contamination; nature and heritage conservation)	<p>This is a large site with access from Southwell Road West, utilities and communications infrastructure are already in place.</p> <p>The site slopes gently from north to south and is within Flood Zone 1 and therefore at low risk of flooding. There are no heritage or environmental designations within or adjacent to the site.</p>	Very Good
Barriers to Delivery and Mitigation (including ownership constraints - if known)	<p>There are a couple of undeveloped sites comprising of land to the south of Oak Leaf Close and land to the south of St Andrew's Healthcare. A small plot south of east of the office blocks is owned by Intelligent Money Limited.</p> <p>No other constraints to redevelopment were apparent from the site visit.</p>	Very Good
Market Attractiveness (including appropriateness, vacancy and market activity on site for the type of development proposed)	This is a large site within the main urban area of Mansfield. It is highly visible from Southwell Road West and is occupied by a range of uses and has low vacancy levels. The development is modern with an open layout and high-quality purpose-built buildings providing an attractive working environment. Despite this, build-out of the site has been slow.	Good
Strategic Fit with Growth Area Objectives (by target Market Segment)	This site already accommodates key industrial growth sectors as identified in the D2N2 Vision 2030 document including professional/business services, healthcare and retail.	Good
OVERALL SITE RATING	Good	
Recommendation and Potential Future Uses	Allocate for employment uses – allocate undeveloped land for employment uses and protect remainder for employment uses (i.e. retain allocation as a key / general employment area).	
SITE SUMMARY:		
This site comprises of modern detached office buildings, car salesrooms, a hospital, a supermarket, a restaurant and a building supplies store. There are a couple of undeveloped sites comprising of land to the south of Oak Leaf Close and land to the south of St Andrew's Healthcare. It is within a wider industrial area along Southwell Road West (A6191) on the south-eastern outskirts of Mansfield. It is adjacent to the Bellamy Road Industrial Estate and the Ratcher Hill employment area, and in close proximity to Oak Tree Business Park and Ransom Wood Business Park. It is designated in the Local Plan as a key / general employment area although it has become increasingly watered down by sui generis and other non-E/B class uses. It is recommended that the undeveloped land is allocated for employment uses and the remainder protected for employment uses.		

Millennium Business Park (Ref: MDC3)



**GROSS SITE AREA:
20.16 ha**

**ESTIMATED NET DEVELOPABLE
AREA:
0.51 ha**

CRITERIA	COMMENT	RATING
<p>Site Context</p> <ul style="list-style-type: none"> • Location with regards to existing employment areas and other sites • How the site fits into the overall portfolio 	<p>This is a modern and successful business park on the northern fringe of Mansfield.</p> <p>The site is approximately 2.5km north of the Penniment Farm site and 3km west of the Old Mill Lane Industrial Estate.</p>	
<p>Local Plan Designation</p>	<p>The Development Plan for Mansfield comprises of the Mansfield District Local Plan 2013-2033 (Adopted September 2020). The site is designated as a Key / General Employment Area (Policy E3c).</p>	
<p>Status in SHLAA</p>	<p>The HELAA (2017) identified a number of smaller areas within the site as follows:</p> <ul style="list-style-type: none"> • Site ref 148 – Millenium Business Park Site A off Concorde Way adjacent to the Bull Farm Primary Care Centre – 0.32 ha – reasonable alternative site. This site is still undeveloped. • Site ref 201 – Land behind Takbro Ltd off Concorde Way – 0.19 ha – unimplemented permission (2017/0100/FUL) – reasonable alternative site. This site is still undeveloped. • Site ref 202 – Plot 10a Enterprise Road – 1.59 ha – planning permission granted (2016/0715/FUL) – reasonable alternative site. This permission has been implemented and the site is occupied by JKS Boyles. 	
<p>Planning History</p>	<p>Recent planning applications include:</p> <ul style="list-style-type: none"> • 2016/0715/FUL – Full planning application – New Industrial Building Incorporating a combination of 	

	<p>workshops (B2 Use) with Associated Offices (B1 Use), Car Parking and External Yard Area</p> <ul style="list-style-type: none"> • 2017/0100/FUL – Full planning application – Erection of a single industrial unit for B1/B2/B8 use – Granted 04.05.2017 • 2017/0323/COU – Change of use application – Change of Use to Gymnasium • 2019/0113/FUL – Full planning application – Extension to Food Production Area and Reposition External Cold Store Plant Equipment to First Floor Internal Plant Room – Granted 24.04.2019 • 2019/0550/FUL – Full planning application – Demolish Wooden Single Storey Side Extension (121 sq.mtr.) and Erect a Single Storey Side Extension (542 sq. mtr.) to Existing Factory – Granted 24.09.2019
<p>Current Use and Land Type</p>	<p>This is a brownfield site occupied by a business park.</p>
<p>Occupier Profile (if partly developed, including % of available land and levels of vacancy onsite)</p>	<p>The development is modern with a spacious attractive layout and high-quality purpose-built buildings providing an attractive working environment.</p> <p>The site is occupied by Use Class E, B2, B8 and sui generis uses. The Mansfield Networkcentre is located on the site and comprises of 12 high quality workspace units. The Bull Farm Primary Care Centre is located in the southern corner of the site and there is a Volkswagen car salesroom in the western corner of the site.</p> <p>Other occupiers include: JKS Boyles (drilling equipment supplier) Howarth Timber Euro Car Parts Trent Ceramics (tile store) Realm Projects (shop fitter) Integrated Doorsets Future Products (double glazing supplier) Solus Scientific (manufacturer of food safety testing equipment)</p> <p>At the time of the site visit (November 2020) the following vacant units were apparent:</p> <ul style="list-style-type: none"> • Unit 1A Isabella Court – 646 sqm warehouse • Unit 3 Concorde Way – 1,061 sqm warehouse <p>There are also a couple remaining development plots on the site:</p> <ul style="list-style-type: none"> • HELAA ref 148 – Millenium Business Park Site A off Concorde Way adjacent to the Bull Farm Primary Care Centre – 0.32 ha – reasonable alternative site. This site is still undeveloped. • HELAA ref 201 – Land behind Takbro Ltd off Concorde Way – 0.19 ha – unimplemented permission (2017/0100/FUL) – reasonable alternative site. This site

	is still undeveloped.	
Strategic Road Access	The site adjoins the A6191 via its access roads (Enterprise Road and Concorde Way). The A6191 converges with the A617 approximately 800m north of the site. The site is 8.3 km from junction 29 of the M1 via the A617.	Average
Local Road Access	The site can be accessed from the A6191 which is a good free-moving road heading North West (Chesterfield Road North) towards the A617 and Pleasley and South East (Chesterfield Road South) towards Mansfield.	Very Good
Proximity to Urban Areas and Access to Labour and Services (including public transport / cycling / walking accessibility)	The site is located on the North West outskirts of Mansfield, with the village of Pleasley approximately 2.4km to the North West of the site and Mansfield Woodhouse approximately 3.2km to the East of the site. Pleasley is a small village with few amenities/services. Mansfield and Mansfield Woodhouse both provide a wide range of facilities and services including schools, medical services and shops. Mansfield also provides a range of recreational facilities and a police station. The Site is serviced by regular bus services via stops on the A6191 travelling South East towards Mansfield and Nottingham and North West towards Chesterfield and Whaley Thorns. Mansfield railway station is just over 4km away and is serviced by regular buses from the A6191. From the site, Mansfield Woodhouse railway station is not accessible by public transport.	Average
Compatibility of Adjoining Uses (including amenity impacts experienced by current/future occupiers and neighbouring areas)	The site is bound by a footpath to the North, North East and North West of the site and beyond that, a solar farm to the North East and greenfield land to the North and North West. The A6191 borders the South West of the site, with residential areas beyond and to the North West and South East.	Average
Developmental and Environmental Constraints (e.g. size; topography; site access; roads, lighting, landscaping, mains utilities and communications infrastructure; flood risk; contamination; nature and heritage conservation)	This is a well-established business park with utilities and communications infrastructure in place. The site is within Flood Zone 1 and therefore at low risk of flooding. There are no historic or environmental designations within or in close proximity to the site.	Very Good
Barriers to Delivery and Mitigation (including ownership constraints - if known)	No obvious barriers to redevelopment were evident from the site visit.	Very Good
Market Attractiveness (including appropriateness, vacancy and market	This is a well-established industrial estate on the northern fringe of Mansfield. The development is	Good

activity on site for the type of development proposed)	modern with a spacious attractive layout and high-quality purpose-built buildings providing an attractive working environment. Vacancy levels were low and there are a couple of small sites potentially suitable for redevelopment.	
Strategic Fit with Growth Area Objectives (by target Market Segment)	This site already accommodates key industrial growth sectors as identified in the D2N2 Vision 2030 document including professional/business services, healthcare, construction and retail.	Average
OVERALL SITE RATING	Good	
Recommendation and Potential Future Uses	Allocate for employment uses (i.e. retain allocation as a key / general employment area)	
SITE SUMMARY:		
<p>This is a modern and successful business park on the northern fringe of Mansfield. The employment uses are diluted by The Bull Farm Primary Care Centre and a Volkswagen car salesroom within the site. Vacancy levels were low and there are a couple of small sites potentially suitable for redevelopment.</p> <p>The site is designated as a key / general employment area in the Local Plan and it is recommended that the site is allocated for employment uses.</p>		

Oakham Business Park (Ref: MDC4)



GROSS SITE AREA: 25.69 ha	ESTIMATED NET DEVELOPABLE AREA: 0 ha
--	---

CRITERIA	COMMENT	RATING
Site Context <ul style="list-style-type: none"> • Location with regards to existing employment areas and other sites • How the site fits into the overall portfolio 	<p>This is a well-established business park within a wider industrial area on the south-western outskirts of Mansfield. It is adjacent to the Hermitage Lane Industrial Estate and the new Amazon distribution centre at Summit Park is approximately 200m to the south.</p>	
Local Plan Designation	<p>The Development Plan for Mansfield comprises of the Mansfield District Local Plan 2013-2033 (Adopted September 2020). The site is designated as a Key / General Employment Area (Policy E3d).</p>	
Status in SHLAA	<p>The HELAA (2017) identified a couple of small sites within the wider site as 'reasonable alternative' sites (ref. 141 and 142).</p>	
Planning History	<p>Recent planning history relates to the employment uses onsite.</p>	
Current Use and Land Type	<p>This is a brownfield site occupied by an established business park.</p>	
Occupier Profile (if partly developed, including % of available land and levels of vacancy onsite)	<p>The site is occupied by a range of B2/B8 warehouses as well as offices and starter units, most are modern units of good quality.</p> <p>Occupiers include: East Midlands Ambulance Support Mansfield Innovation Centre (business centre) Belton Massey Catalysts Total Integrated Solutions (security system installer)</p>	

	<p>Capita (intelligent communications) Marstons Logistics (food and drink) Paccor Packaging (manufacturing) Kent Group (electrical engineering) HAB Motorhomes (dealer) Mayborn Group Sangenic (baby products manufacturer) CEF Trade (electrical wholesaler) Glenair (electronics manufacturer) Reflex Labels (manufacturer) There were low vacancy levels at the time of the site visit (November 2020). There were only a number of offices to let in the Mansfield Innovation Centre and Enterprise Court.</p>	
Strategic Road Access	<p>The site is 1km from the A60 heading North East, 0.6km from the A38 heading North West and 0.5km from the A617 to the South West. The site is 9.3km from junction 28 of the M1 via the A617 and A38.</p>	Poor / Average
Local Road Access	<p>The site is accessed via Hamilton Way which runs from the North East through to the South West of the site. From the North East, Hamilton Way adjoins Sheepbridge Lane which is a good free-moving residential road eventually meeting the A60 heading South East (passing a Primary School). From the South West, Hamilton Way is accessed via Hamilton Road which meets the A617 after 0.5km.</p>	Good
Proximity to Urban Areas and Access to Labour and Services (including public transport / cycling / walking accessibility)	<p>The site is located on the South West outskirts of Mansfield, located 3.2km to the North East of the site via the A38. The town of Sutton-in-Ashfield is approximately 4km to the west of the site via the A617 and B6023.</p> <p>Mansfield and Sutton-in-Ashfield both provide a wide range of facilities and services including schools, medical services and shops. Mansfield also provides a range of recreational facilities and a police station.</p> <p>There are bus stops along Hamilton Way with services to Mansfield.</p> <p>Mansfield railway station is just over 2km away and is serviced by regular buses from the A38.</p>	Good
Compatibility of Adjoining Uses (including amenity impacts experienced by current/future occupiers and neighbouring areas)	<p>The site is bound to the North by the River Maun and Sheepbridge Lane with allotments and residential areas beyond, to the east by Oakham Nature Reserve and a small fishing lake, to the south by the new Amazon distribution centre at Summit Park and to the west by the wider Hermitage Lane industrial area.</p>	Good
Developmental and	<p>This is a large established business park with</p>	Poor

<p>Environmental Constraints (e.g. size; topography; site access; roads, lighting, landscaping, mains utilities and communications infrastructure; flood risk; contamination; nature and heritage conservation)</p>	<p>access from Hamilton Way and internal spine roads, utilities and communications infrastructure are already in place.</p> <p>The site slopes gently from north to south. The majority of the site is within Flood Zone 1 and therefore at low risk of flooding. However, there is a small area south of Sheepbridge Lane within Flood Zone 2 and 3.</p> <p>The Oakham Local Nature Reserve intersects the site and bounds the site to the east. Matlock Mill Joinery works within the northern portion of the site is grade II listed (ref. 1279862).</p> <p>Quarry Lane Local Nature Reserve is located immediately north of the site. Drury Dam Viaduct (grade II listed ref. 1207187), Hermitage Mill (grade II listed ref. 1288578) and the railway bridge 100 metres west of Hermitage Mill (grade II listed ref. 1207169) are within 400m of the site. The Hermitage Local Nature Reserve and King's Mill Viaduct scheduled monument are within 500m of the site.</p>	
<p>Barriers to Delivery and Mitigation (including ownership constraints - if known)</p>	<p>The majority of the site is in MDC ownership. The site is fully developed. Any redevelopment of the site would need to consider the environmental and heritage constraints listed above.</p>	Average
<p>Market Attractiveness (including appropriateness, vacancy and market activity on site for the type of development proposed)</p>	<p>This is a large site within the main urban area of Mansfield. It is occupied by a range of employment uses and has low vacancy levels. This is a high-quality modern employment area based on the Hamilton Lane corridor. The overall environmental quality is high.</p>	Very Good
<p>Strategic Fit with Growth Area Objectives (by target Market Segment)</p>	<p>This site already accommodates key industrial growth sectors as identified in the D2N2 Vision 2030 document including professional/business services, creative & digital, food & drink manufacturing, health & social care, logistics & e-commerce and retail.</p>	Good
<p>OVERALL SITE RATING</p>	<p>Good</p>	
<p>Recommendation and Potential Future Uses</p>	<p>Protect for employment uses (i.e. retain allocation as a key / general employment area)</p>	
<p>SITE SUMMARY:</p>		
<p>This is a well-established and popular industrial estate within a wider industrial area on the south-western outskirts of Mansfield. It is adjacent to the Hermitage Lane Industrial Estate and the new Amazon distribution centre at Summit Park is approximately 200m to the south. The site has a number of environmental and heritage constraints including areas at risk of flooding as well as Local Nature Reserves and heritage assets within or in close proximity to the site. The site</p>		

accommodates a range of B2/B8 warehouses as well as offices and starter units and the Mansfield Innovation Centre in a high-quality environment. The site is designated as a key / general employment area in the Local Plan and it is recommended that the site is protected for employment uses.

Oak Tree Business Park (Ref: MDC5)

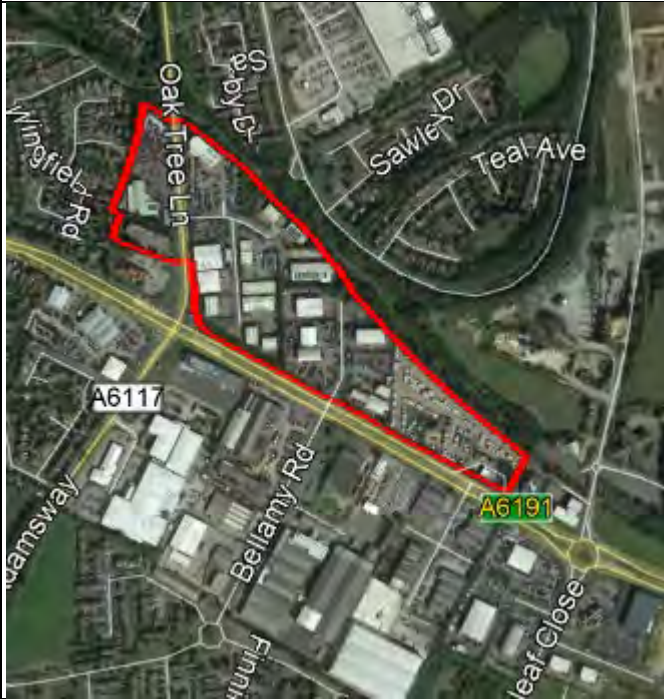

GROSS SITE AREA:
10.05 ha

ESTIMATED NET DEVELOPABLE AREA:
0 ha

CRITERIA	COMMENT	RATING
<p>Site Context</p> <ul style="list-style-type: none"> • Location with regards to existing employment areas and other sites • How the site fits into the overall portfolio 	<p>This site comprises of car salesrooms, MOT and service centres, some workspaces, caravan storage and homewares supply stores.</p> <p>The site is within a wider industrial area along Southwell Road West (A6191) on the south-eastern outskirts of Mansfield. It is adjacent to Ratcher Hill Employment Area and Quarry, and across the road from Bellamy Road Industrial Estate.</p>	
<p>Local Plan Designation</p>	<p>The Development Plan for Mansfield comprises of the Mansfield District Local Plan 2013-2033 (Adopted September 2020). The site is designated as a Key / General Employment Area (Policy E3e).</p>	
<p>Status in SHLAA</p>	<p>N/A</p>	
<p>Planning History</p>	<p>No recent planning history.</p>	
<p>Current Use and Land Type</p>	<p>This is a brownfield site currently occupied by a range of employment and sui generis uses.</p>	
<p>Occupier Profile (if partly developed, including % of available land and levels of vacancy onsite)</p>	<p>The site is primarily occupied by car salesrooms (Renault, Honda, Hyundai, Toyota and Peugeot), MOT and service centres, an Esso petrol filling station and a caravan storage site. There are a range of B2/B8 units off Oakwood Road/Acorn Way. Other occupiers include: Mansfield Sand, The Paint Shack.com, Water Direct, Sherwood Aluminium Systems and City Plumbing Supplies</p> <p>At the time of the site visit (November 2020) all units appeared to be occupied.</p>	

	The site would benefit from investment in public realm, boundaries and landscaping.	
Strategic Road Access	The site adjoins the A6191 via its access roads (Sovereign Way and Oakwood Road via Oak Tree Lane) and is 14.5km from junction 28 of the M1 via the A617 and A38.	Average
Local Road Access	The site can be accessed from the A6191 which is a good free-moving road heading North West towards Mansfield and South East towards the B6020 (Mansfield Road) and the A617. The B6020 continues South East towards Rainworth. The A617 continues East towards Newark-on-Trent and West towards Sutton-in-Ashfield.	Very Good
Proximity to Urban Areas and Access to Labour and Services (including public transport / cycling / walking accessibility)	<p>The site is located on the south-eastern periphery of Mansfield. Mansfield town centre provides a wide range of facilities and services including schools, medical services, shops, recreational facilities and a police station. Mansfield railway station is 5km away and is serviced by regular buses from the A6191 and A6117.</p> <p>The site is 2.9km North West of Rainworth village via the A6191 and B6020 which provides schools, a health centre, local shops, post office and takeaway.</p> <p>The Site is serviced by regular bus services via stops on the A6191 travelling South East (towards Nottingham and Rainworth, and less frequent services to Newark, Blidworth, Bilsthorpe and Eakring) and North West (towards Mansfield and Sutton in Ashfield). The North West of the site is also serviced by bus stops on the A6117 (Oak Tree Lane) for hourly services towards Mansfield and Forrest Town.</p>	Average / Good
Compatibility of Adjoining Uses (including amenity impacts experienced by current/future occupiers and neighbouring areas)	The site is bordered by mature trees with residential/commercial areas to the north, to the east by the Ratcher Hill employment area and quarry including the Mansfield Asphalt plant, to the south by the A6191 and to the west by residential areas.	Average
Developmental and Environmental Constraints (e.g. size; topography; site access; roads, lighting, landscaping, mains utilities and communications infrastructure; flood risk; contamination; nature and heritage conservation)	<p>This is a medium-sized site occupied by a range of employment and sui generis uses with utilities and communications infrastructure in place. It slopes gently down to the north.</p> <p>The site is within Flood Zone 1 and therefore at low risk of flooding. There are no heritage designations within or in close proximity to the</p>	Very Good

	<p>site.</p> <p>Oak Tree Heath Local Nature Reserve is within 250m of the site to the north.</p>	
<p>Barriers to Delivery and Mitigation (including ownership constraints - if known)</p>	<p>The site is fully developed. No other barriers to redevelopment were obvious at the site visit.</p>	<p>Very Good</p>
<p>Market Attractiveness (including appropriateness, vacancy and market activity on site for the type of development proposed)</p>	<p>This site has significant visibility and frontage onto the A6191 and is within the wider Southwell Road West industrial area. Vacancy levels were low.</p>	<p>Good</p>
<p>Strategic Fit with Growth Area Objectives (by target Market Segment)</p>	<p>This site already accommodates key industrial growth sectors as identified in the D2N2 Vision 2030 document including professional/business services, construction and retail.</p>	<p>Average</p>
<p>OVERALL SITE RATING</p>	<p>Average</p>	
<p>Recommendation and Potential Future Uses</p>	<p>Protect for employment uses (i.e. retain allocation as a key / general employment area)</p>	
<p>SITE SUMMARY:</p> <p>This site comprises of a mix of sui generis and employment uses - primarily car salesrooms, MOT and service centres, caravan storage and homewares supply stores. The site is within a wider industrial area along Southwell Road West (A6191) on the south-eastern outskirts of Mansfield. It is adjacent to Ratcher Hill Employment Area and Quarry, and across the road from Bellamy Road Industrial Estate. The site is fully developed and vacancy levels were low at the time of the site visit. The site is designated as a key / general employment area in the Local Plan and although it is dominated by Sui Generis uses with few E/B Class uses, it is recommended that the site is protected for employment uses.</p>		

Broadway Industrial Estate (Ref: MDC6)



GROSS SITE AREA:
4.24 ha

ESTIMATED NET DEVELOPABLE AREA:
0 ha

CRITERIA	COMMENT	RATING
<p>Site Context</p> <ul style="list-style-type: none"> • Location with regards to existing employment areas and other sites • How the site fits into the overall portfolio 	<p>This is a small existing employment site near the centre of Mansfield. The site is approximately 2km north east of the Hamilton Way industrial area and approximately 2.5km east of the Southwell Road West industrial area.</p>	
<p>Local Plan Designation</p>	<p>The Development Plan for Mansfield comprises of the Mansfield District Local Plan 2013-2033 (Adopted September 2020). The site is designated as a Key / General Employment Area (Policy E3g).</p>	
<p>Status in SHLAA</p>	<p>N/A</p>	
<p>Planning History</p>	<p>No recent planning history.</p>	
<p>Current Use and Land Type</p>	<p>This is a brownfield site occupied by an industrial estate.</p>	
<p>Occupier Profile (if partly developed, including % of available land and levels of vacancy onsite)</p>	<p>The site is occupied by a mixture of office space and B2/B8 industrial units. Non-employment uses include: Ace Carwash, Personal Best Academy (martial arts school), 776 Gymnastics and My Dentist.</p> <p>Severn Trent Water offices are located off Great Central Road, other employment uses include:</p> <p>RB Wholesale Catering Supplier Jewson builder's merchants Brandon Tool Hire Alma Engineering R&K Garage vehicle repairs</p>	

	<p>Clays Motors MOT Centre M J Stenson builder J&P Samples clothing manufacturer Arrowdale builder Heat Care plumber Electrotec BMS (energy equipment manufacturer) Mansfield Steel (manufacturer of outdoor shelters and street furniture)</p> <p>At the time of the site visit there was one unit on the market – a modern detached office/workshop comprising of 398 sqm.</p>	
Strategic Road Access	<p>The site is within 200m of the A60 via the A6191. The A60 heads north to Worksop and south to Nottingham. The A38 is approximately 1.3km from the site via the A60 and the A6191 is approximately 1km from the site via the A60.</p>	Poor
Local Road Access	<p>The site is accessed from Great Central Road to the east and the site's internal access road The Broadway. Great Central Road converges with the A6191 to the north which is a good free-moving road. The A6191 joins the A60 approximately 200m west of the site.</p>	Good
Proximity to Urban Areas and Access to Labour and Services (including public transport / cycling / walking accessibility)	<p>The site is situated within the Mansfield urban area approximately 1km from Mansfield railway station. Mansfield provides a wide range of facilities and services including schools, medical services, shops and recreational facilities.</p> <p>The A6191 adjoining the site provides a regular bus service to Mansfield and less frequent services to Sutton in Ashfield, Newark, Eakring, Rainworth, Oak Tree and Nottingham.</p>	Very Good
Compatibility of Adjoining Uses (including amenity impacts experienced by current/future occupiers and neighbouring areas)	<p>The site is bound by the A6191 to the north with residential and commercial uses beyond, by residential properties to the east and south and by Great Central Road to the west with Mansfield Police Station beyond.</p>	Poor
Developmental and Environmental Constraints (e.g. size; topography; site access; roads, lighting, landscaping, mains utilities and communications infrastructure; flood risk; contamination; nature and heritage conservation)	<p>This is a small employment site with utilities and communications infrastructure in place. There is a telecommunications mast located in the north-western corner of the site.</p> <p>33 Ratcliffe Gate opposite the site is Grade II listed (ref. 1215108). There is a cluster of listed buildings along Nottingham Road and also around Bridge Street, both within 400m to the west of the site.</p> <p>There are no environmental designations on or</p>	Average

	within close proximity to the site. The site is within Flood Zone 1 and therefore at low risk of flooding.	
Barriers to Delivery and Mitigation (including ownership constraints - if known)	Any future redevelopment of the site would need to take the amenity impact upon adjoining residential uses into consideration. The site is fully developed and no other constraints to redevelopment were evident from the site visit.	Average
Market Attractiveness (including appropriateness, vacancy and market activity on site for the type of development proposed)	This is a small existing employment site located close to the town centre with good local road access and access to labour markets and services. Vacancy levels were low at the time of the site visit. It would benefit from investment in public realm and landscaping.	Average
Strategic Fit with Growth Area Objectives (by target Market Segment)	This site does not currently accommodate key industrial growth sectors as identified in the D2N2 Vision 2030 document. However, it is located within Mansfield urban area and has potential to accommodate key industrial growth sectors.	Poor
OVERALL SITE RATING	Average	
Recommendation and Potential Future Uses	Protect for employment uses (i.e. retain allocation as a key / general employment area)	
SITE SUMMARY:		
This is a small existing employment site near the centre of Mansfield. The site is approximately 2km north east of the Hamilton Way industrial area and approximately 2.5km east of the Southwell Road West industrial area. The site is occupied by a mixture of office space and B2/B8 industrial units as well as some non-employment uses. The site is fully developed and only one unit was available at the time of the site visit. The site is designated as a key / general employment area in the Local Plan and it is recommended that the site is protected for employment uses.		

Crown Farm Industrial Estate (Ref: MDC7)



**GROSS SITE AREA:
56.64 ha**

**ESTIMATED NET DEVELOPABLE AREA:
4.05 ha**

(Comprising of HELAA sites 137, 143 and 216 which were still undeveloped. If the SUE2 (Land off Jubilee Way) allocation comes forward this could increase the net developable area by 1.6 ha.)

CRITERIA	COMMENT	RATING
<p>Site Context</p> <ul style="list-style-type: none"> • Location with regards to existing employment areas and other sites • How the site fits into the overall portfolio 	<p>This is a well-established industrial estate on the eastern fringe of Mansfield. The site provides accommodation to a number of key occupiers within the region including Toray Textiles, Crown Packaging, Plastek Limited and sps Aerostructures.</p> <p>The site is approximately 2km north of the Southwell Road West industrial area.</p>	
<p>Local Plan Designation</p>	<p>The Development Plan for Mansfield comprises of the Mansfield District Local Plan 2013-2033 (Adopted September 2020). The site is designated as a Key / General Employment Area (Policy E3j).</p> <p>There is an allocation for a Strategic Urban Extension SUE2 (Land off Jubilee Way) which is immediately to the south of the site. It comprises of 46.83 ha for c.800 dwellings and 1.6 ha (net developable area) extension to Crown Farm Industrial Estate. There is a housing allocation H1a (Clipstone Road East) immediately north east of the site which is split into two sections for 313 in the western portion and 198 dwellings in the eastern portion.</p>	
<p>Status in SHLAA</p>	<p>The HELAA (2017) identified a number of smaller areas within the site as follows:</p> <ul style="list-style-type: none"> • 71a – Site A, Long Stoop Way – 2.28ha – proposals for 	

	<p>modification/intensification of employment use however, the site is tenanted – reasonable alternative site.</p> <ul style="list-style-type: none"> • 71c – Site C, Long Stoop Way – 0.6 ha - proposals for modification/intensification of employment use however, the site is tenanted – reasonable alternative site. • 137 – Plot 17, Long Stoop Way – 0.25ha – lapsed planning permission – reasonable alternative site. This site is still vacant. • 143 – Crown Farm Industrial Estate Site A – 2.77 ha – not being actively promoted by the landowner – reasonable alternative site. This site is still vacant and comprises of the existing Local Plan allocation. • 216 - Crown Speciality Packaging UK Limited – 1.03ha – permission granted (2017/0843/FUL) – reasonable alternative site. This permission has not yet been implemented.
Planning History	<p>Recent applications on the site include:</p> <ul style="list-style-type: none"> • 2020/0156/FUL – Erection of an industrial stage unit - Plot 6 Mansfield Brick Crown Farm Way – awaiting decision – validated 27.03.2020 • 2017/0843/FUL – Erection of single storey storage building - Crown Speciality Packaging UK Limited, Crown Farm Way – granted – 14.02.2018. This permission has not yet been implemented. <p>There are a number of other historic and minor applications relating to the employment uses on the site.</p>
Current Use and Land Type	This is a brownfield site occupied by B2/B8 employment uses.
Occupier Profile (if partly developed, including % of available land and levels of vacancy onsite)	<p>The site provides modern accommodation to a number of key occupiers within the region including Toray Textiles, Crown Packaging, Plastek Limited and sps Aerostructures.</p> <p>At the time of the site visit (November 2020) there appeared to be only one vacant unit – a warehouse of 9,886 sqm on Crown Farm Way.</p> <p>There are a few remaining development plots on the site:</p> <ul style="list-style-type: none"> • HELAA site 137 – Plot 17, Long Stoop Way – 0.25ha – lapsed planning permission – reasonable alternative site. This site is still vacant. • HELAA site 143 – Crown Farm Industrial Estate Site A – 2.77 ha – not being actively promoted by the landowner – reasonable alternative site. This site is still vacant. • HELAA site 216 - Crown Speciality Packaging UK Limited – 1.03ha – permission granted (2017/0843/FUL) – reasonable alternative site. This permission has not yet been implemented.
Strategic Road Access	The A6117 runs along the West of the site and
	Poor

	<p>provides access to the site entry road, Crown Farm Way, which runs through the centre of the site.</p> <p>The M1 is 16km East from junction 28 of the M1 via the A6117, A617 and A38. The A60 is 2.5km from the site via the A6117 to the North</p>	
Local Road Access	<p>The site can be accessed via the A6117 which is a good, free-moving, largely residential road which heads South and adjoins the A6191 after 2km. The A60 (via the A6117) heads north towards Mansfield Woodhouse and South towards the centre of Mansfield.</p>	Good
Proximity to Urban Areas and Access to Labour and Services (including public transport / cycling / walking accessibility)	<p>The site is located to the south of Forest Town and approximately 3.2km east of Mansfield town Centre. Both settlements provide a wide range of facilities and services including schools, medical services and shops. Mansfield also provides a range of recreational facilities and a police station.</p> <p>The site is served by convenient bus stops on Crown Farm Way, Long Stop Way and Fletchers Way. In addition, busses from the B6030 (0.6km from the site) regularly service Mansfield and Mansfield train station to the West and Forest Town, Clipstone, Walesby and Kirton to the East.</p> <p>National Cycle Route 6 is approximately 1km east of the site with connecting cycle paths from Crown Farm Way.</p>	Average / Good
Compatibility of Adjoining Uses (including amenity impacts experienced by current/future occupiers and neighbouring areas)	<p>The site is bound by mature tree borders to the North and South and residential areas beyond. The A6117 borders the site to the West and greenfield land and Sherwood Forest golf club to the East.</p>	Average
Developmental and Environmental Constraints (e.g. size; topography; site access; roads, lighting, landscaping, mains utilities and communications infrastructure; flood risk; contamination; nature and heritage conservation)	<p>This is a large site occupied by B2/B8 employment uses with utilities and communications infrastructure in place. The site slopes gently down to the north and overhead lines run adjacent to Crown Farm Way.</p> <p>The site is within Flood Zone 1 and therefore at a low risk of flooding. There are areas of higher risk along the site's northern and eastern boundaries.</p> <p>Vicar Water Nature Reserve is approximately 300m east of the site. Sherwood Forest Golf Course SSSI is approximately 700m east of the site.</p>	Good

	The Grade II listed Kingsway Hall (ref. 1251849) is approximately 400m north of the site.	
Barriers to Delivery and Mitigation (including ownership constraints - if known)	No obvious barriers to redevelopment were evident from the site visit.	Very Good
Market Attractiveness (including appropriateness, vacancy and market activity on site for the type of development proposed)	This is a well-established industrial estate on the eastern fringe of Mansfield. The site provides accommodation to a number of key occupiers within the region including Toray Textiles, Crown Packaging, Plastek Limited and sps Aerostructures. Vacancy levels were low and a number of sites potentially suitable for redevelopment were available. The area would benefit from investment in public realm, signage and landscaping in places.	Good
Strategic Fit with Growth Area Objectives (by target Market Segment)	This site already accommodates key industrial growth sectors as identified in the D2N2 Vision 2030 document including professional/business services, construction and retail.	Average
OVERALL SITE RATING	Good	
Recommendation and Potential Future Uses	Allocate for employment uses (i.e. retain allocation as a key / general employment area)	
SITE SUMMARY:		
<p>This is a well-established industrial estate on the eastern fringe of Mansfield. The site provides accommodation to a number of key occupiers within the region including Toray Textiles, Crown Packaging, Plastek Limited and sps Aerostructures. The site is approximately 2km north of the Southwell Road West industrial area. Vacancy levels were low and there were a number of sites potentially suitable for redevelopment. If the SUE2 (Land off Jubilee Way) allocation comes forward in accordance with the Local Plan, including an extension to the Crown Farm Industrial Estate, this could increase the net developable area by 1.6 ha. The site is designated as a key / general employment area in the Local Plan and it is recommended that the site is allocated for employment uses.</p>		

Gateway Off Grove Way (Ref: MDC8)

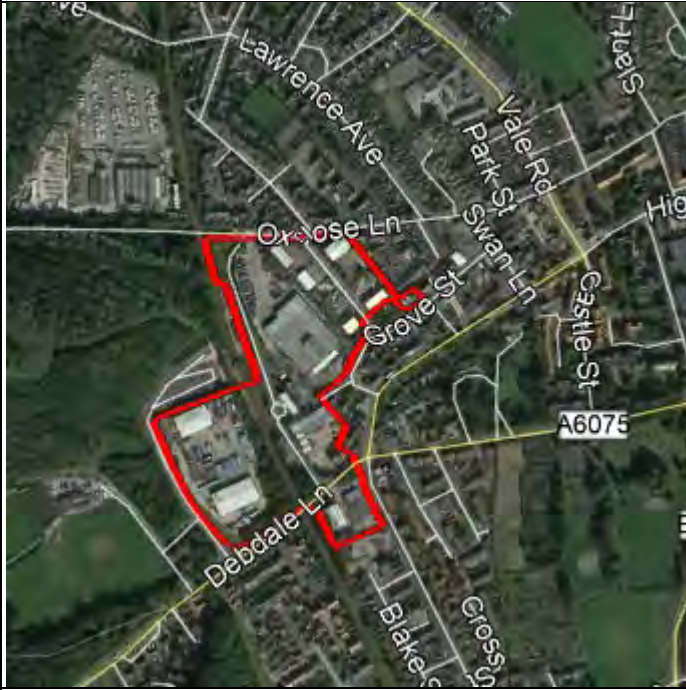

GROSS SITE AREA:
7.35 ha

ESTIMATED NET DEVELOPABLE AREA:
0 ha

CRITERIA	COMMENT	RATING
<p>Site Context</p> <ul style="list-style-type: none"> • Location with regards to existing employment areas and other sites • How the site fits into the overall portfolio 	<p>This is a small existing employment site adjacent to Mansfield Woodhouse Railway Station and intersected by the railway line. The site is 1.2km north-west of the Old Mill Lane Industrial Estate and approximately 1.8km east of the Millennium Business Park.</p>	
<p>Local Plan Designation</p>	<p>The Development Plan for Mansfield comprises of the Mansfield District Local Plan 2013-2033 (Adopted September 2020). The site is designated as a Key / General Employment Area (Policy E3k).</p>	
<p>Status in SHLAA</p>	<p>The HELAA (2017) identified an area within the site – land and buildings off Debdale Lane (0.48 ha); however, the site's availability was unknown, and it appeared to be in active employment use. The site was excluded at Stage 2. At the time of the site visit this was occupied by B&J Parr plastics recycling facility.</p>	
<p>Planning History</p>	<p>No recent planning history.</p>	
<p>Current Use and Land Type</p>	<p>This is a brownfield site in employment use.</p>	
<p>Occupier Profile (if partly developed, including % of available land and levels of vacancy onsite)</p>	<p>Redfern Travel and S&G Coachworks are located immediately to the west of the railway line and east of The Sidings. Immediately east of the railway line there is a small modern office development 'Woodhouse Station Gateway Centre' occupied by This is Kode (web designers) and Mansfield Fire Safety Training Centre. The Woodhouse Station Enterprise Centre is also located here and comprises of starter offices. These are occupied by Moneypennys, Omega Wolf Security,</p>	

	<p>Sports Injury Clinic and two of these units were vacant.</p> <p>To the south of Debdale Lane there is Davenport Accident Repair Centre, Line-X vehicle repairs and Spot-on 2 Snooker and Pool Club.</p> <p>AM Packaging and B&J Parr (plastics recycling facility) are located to the north of Debdale Lane. Off Grove Way there are a number of smaller workshops with occupiers including: D&D Engineering, The Tyre Bay, MB Motors Commercial Sales, Haynes Electrical Services and Blinds by Grace. Off Grove Street there are a few small workshop units occupied by Country Cradles and Picturesque.</p>	
Strategic Road Access	<p>The site is 1.3km from the A60 to the North East and 2.2km from the A6191 to the South West, both accessible via the A6075. Junction 29 of the M1 is approximately 10.8km from the site via the A6075 and A6191/A617.</p>	Poor
Local Road Access	<p>The site is accessed via The Sidings to the west of the site, Sherwood Street to the south east of the site and Station Hill (via Priory Square) leading to Grove Way to the east. All access roads adjoin the A6075 which is a good free-moving road; however, access is constrained by a restricted-height railway bridge (max height 4.0m and only passable by one vehicle at a time) which passes over the road to the south of the site.</p> <p>Grove Way adjoins Oxclose Lane to the north – Oxclose Lane is a narrow unsurfaced road only passable by one vehicle at a time and further constrained by a restricted-height railway bridge (max height 4.5m) to the north of the site.</p>	Poor
Proximity to Urban Areas and Access to Labour and Services (including public transport / cycling / walking accessibility)	<p>The site is situated within the town of Mansfield Woodhouse and approximately 2.3km from Mansfield Town Centre. Both towns provide a wide range of facilities and services including schools, medical services and shops. Mansfield also provides a range of recreational facilities and a police station.</p> <p>Mansfield Woodhouse railway station is situated directly adjacent to the site which provides regular train services to Mansfield and beyond towards Nottingham to the South and Worksop to the North.</p> <p>The A6075 adjoining the site provides a regular bus service to Mansfield. Sherwood Street (0.8km from the site) provides regular bus services towards Mansfield, South Normanton, Alferton and Huthwaite.</p>	Very Good

<p>Compatibility of Adjoining Uses (including amenity impacts experienced by current/future occupiers and neighbouring areas)</p>	<p>The site is bordered by Oxclose Lane to the north with residential areas and caravan storage beyond, by residential areas to the east, by Debdale Lane and residential areas to the south and by Debdale Park and Sports Club to the west. The East Midlands Railway line runs through the centre of the site.</p>	<p>Poor</p>
<p>Developmental and Environmental Constraints (e.g. size; topography; site access; roads, lighting, landscaping, mains utilities and communications infrastructure; flood risk; contamination; nature and heritage conservation)</p>	<p>This is a small and awkward-shaped site with significant changes in levels adjacent to the railway line. The railway line intersects the site from north to south. The site has utilities and communications infrastructure in place.</p> <p>There is a cluster of listed buildings within 400m west of the site at Debdale Hall. There is also a cluster of listed buildings along Station Street within 400m east of the site. There are no environmental designations on or within close proximity to the site.</p> <p>The site is within Flood Zone 1 and therefore at low risk of flooding.</p>	<p>Poor</p>
<p>Barriers to Delivery and Mitigation (including ownership constraints - if known)</p>	<p>The site is fully developed and intersected by the railway line. No obvious barriers to redevelopment were evident from the site visit.</p>	<p>Average</p>
<p>Market Attractiveness (including appropriateness, vacancy and market activity on site for the type of development proposed)</p>	<p>A small, awkward-shaped brownfield site within a lower value area, close to busy junction and surrounded by residential uses. The units adjacent to the railway line are more modern and in good condition; however, the units off Grove Way were more dated with some in poor condition. The environment is poor and the site would benefit from investment in public realm, landscaping and upgrading. The site was occupied by a range of employment, leisure (use class E) and sui generis uses and vacancy levels were low. The site meets local demand for starter offices/workshops.</p>	<p>Average</p>
<p>Strategic Fit with Growth Area Objectives (by target Market Segment)</p>	<p>This site already accommodates key industrial growth sectors as identified in the D2N2 Vision 2030 document including professional/business services, healthcare and creative and digital.</p>	<p>Average</p>
<p>OVERALL SITE RATING</p>	<p>Average</p>	
<p>Recommendation and Potential Future Uses</p>	<p>Protect for employment uses (i.e. retain allocation as a key / general employment area)</p>	
<p>SITE SUMMARY:</p>		
<p>This is a small existing employment site adjacent to Mansfield Woodhouse Railway Station and intersected by the railway line. It is an awkward-shaped site with significant level changes, some</p>		

restricted local road access and surrounded by residential areas. The units adjacent to the railway line are more modern and in good condition however, the units off Grove Way were more dated with some in poor condition. The site is primarily occupied by employment uses with limited leisure (use class E) and sui generis uses, vacancy levels were low. The site meets local demand for starter offices/workshops with good proximity to urban areas and services. The site is designated as a key / general employment area in the Local Plan and it is recommended that the site is protected for employment uses.

Ransom Wood Business Park (Ref: MDC9)



**GROSS SITE AREA:
7.23 ha**

**ESTIMATED NET DEVELOPABLE
AREA:
1.61 ha**
*Note: Based on the HELAA sites discussed
below*

CRITERIA	COMMENT	RATING
<p>Site Context</p> <ul style="list-style-type: none"> • Location with regards to existing employment areas and other sites • How the site fits into the overall portfolio 	<p>This former hospital site is located within established woodland and has been successfully converted into a popular business park. It is within a wider industrial area along Southwell Road West (A6191) on the south-eastern outskirts of Mansfield. It is adjacent to the Ratcher Hill employment area, and in close proximity to the Sherwood Oaks Business Park.</p>	
<p>Local Plan Designation</p>	<p>The Development Plan for Mansfield comprises of the Mansfield District Local Plan 2013-2033 (Adopted September 2020). The site is designated as a Key / General Employment Area (Policy E3l).</p>	
<p>Status in SHLAA</p>	<p>The HELAA (2017) identified a few smaller sites within the wider site as 'reasonable alternative' sites (site ref. 39a comprising of 1.35ha and site ref. 39b comprising of 0.26ha parking areas/grassland). However, the owner has stated there are no current plans for office development during the plan period as the focus is on developing other parts of the site for wider commercial uses.</p>	
<p>Planning History</p>	<p>There are a number of historical planning applications relating to the current uses on the site.</p>	
<p>Current Use and Land Type</p>	<p>This is a brownfield site occupied by a business park set within a woodland.</p>	
<p>Occupier Profile</p>	<p>The site is occupied by a number of detached office buildings.</p>	

<p>(if partly developed, including % of available land and levels of vacancy onsite)</p>	<p>Occupiers primarily include businesses within the professional and business services, creative and digital and healthcare industries. There is also a nursery, wellbeing centre and café/conference venue onsite.</p> <p>Tenants include:</p> <p>Creative Care (east Midlands) Ltd Finning (machinery supplier) BMI Healthcare ABL Health NHIS (National Health Interview Survey) A number of Hypnotherapy, Psychotherapy and Counselling providers. Rippon Homes (developer) Home Repair Network Limited BFS Accountants Skills Forward (software company) Eventure (web design) Education Mutual Brides and Mothers Designer Wedding Outlet Forever Green Café and Conference Venue Cedar House Day Nursery</p> <p>The site has a medium vacancy level, at the time of the site visit (November 2020) there were 25 office units of varying sizes available to let, comprising of a total of 2,454 sqm.</p>	
<p>Strategic Road Access</p>	<p>The site is accessed via the A6191 to the South West. The A6191 continues 4.3km North West to the A60 and Junction 28 of the M1 is 14.6km West of the site via the A617 and A38.</p>	<p>Average</p>
<p>Local Road Access</p>	<p>The site can be accessed via the A6191 which is a good free-moving road heading North West towards Mansfield and South East towards the B6020 (Mansfield Road) and the A617. The B6020 continues South East towards Rainworth. The A617 continues East towards Newark-on-Trent and West towards Sutton-in-Ashfield.</p>	<p>Very Good</p>
<p>Proximity to Urban Areas and Access to Labour and Services (including public transport / cycling / walking accessibility)</p>	<p>The site is located on the south-eastern outskirts of Mansfield. Mansfield town centre provides a wide range of facilities and services including schools, medical services, shops, recreational facilities and a police station. The residential suburb of Berry Hill is located to the south west of the site. The site is also to the east of Oak Tree Lane and surrounding residential area, as well as the Tesco Extra. The site is located 1.6 km North West of Rainworth village via the A6191 and B6020 which provides schools, a health centre, local shops, post office and takeaway.</p> <p>The site is serviced by regular bus services via</p>	

	<p>stops on the A6191 travelling South East (towards Nottingham and Rainworth, and less frequent services to Newark, Blidworth, Bilsthorpe and Eakring) and North West (towards Mansfield and Sutton in Ashfield).</p> <p>Mansfield railway station is 5km away and is serviced by regular bus stops on the A6191.</p>	
Compatibility of Adjoining Uses (including amenity impacts experienced by current/future occupiers and neighbouring areas)	The site is densely bordered by mature trees with greenfield land beyond to the North/East, Mansfield Asphalt plant to the North/West and a solar farm to the South East.	Very Good
Developmental and Environmental Constraints (e.g. size; topography; site access; roads, lighting, landscaping, mains utilities and communications infrastructure; flood risk; contamination; nature and heritage conservation)	<p>This is a relatively level site set within a dense woodland, utilities and communications infrastructure is in place. The site is accessed via internal spine roads from the A6191.</p> <p>The site is within Flood Zone 1 and therefore at low risk of flooding. There are no heritage designations within or in close proximity to the site.</p> <p>Strawberry Hill Heaths SSSI is approximately 400m north of the site. Oak Tree Heath Local Nature Reserve is approximately 650m north east of the site.</p>	Very Good
Barriers to Delivery and Mitigation (including ownership constraints - if known)	<p>There are a couple of small undeveloped sites within the business park which could accommodate limited sensitive development subject to availability being confirmed by the landowner.</p> <p>No other constraints to redevelopment were apparent from the site visit.</p>	Very Good
Market Attractiveness (including appropriateness, vacancy and market activity on site for the type of development proposed)	This is a successful business park set within an established woodland on the outskirts of Mansfield. The site provides facilities for businesses including a nursery, café and conference centre and a wellbeing centre. There were a reasonable number of vacancies at the time of the site visit and some older buildings would benefit from investment.	Good
Strategic Fit with Growth Area Objectives (by target Market Segment)	This site already accommodates key industrial growth sectors as identified in the D2N2 Vision 2030 document including professional/business services, creative and digital and healthcare.	Good
OVERALL SITE RATING	Good	
Recommendation and Potential Future Uses	<p>Allocate for employment uses (i.e. retain allocation as a key / general employment area)</p> <p>There is potential scope for mixed use development E, B2, C1</p>	

on small undeveloped sites within the designation.

SITE SUMMARY:

This former hospital site is located within established woodland and has been successfully converted into a popular business park. It is within a wider industrial area along Southwell Road West (A6191) on the south-eastern outskirts of Mansfield. It is adjacent to the Ratcher Hill employment area and in close proximity to the Sherwood Oaks Business Park. The site is primarily occupied by businesses within the professional and business services, creative and digital and healthcare industries. There is also a nursery, wellbeing centre and café/conference venue onsite.

There were a reasonable number of vacancies at the time of the site visit. There are a couple of small undeveloped sites within the business park which could accommodate limited sensitive development subject to availability being confirmed by the landowner. The site is designated as a key / general employment area in the Local Plan and it is recommended that the site is allocated for employment uses. There is potential scope for mixed use development E, B2, C1 on small undeveloped sites within the designation.

Bellamy Road Industrial Estate (Ref: MDC10)

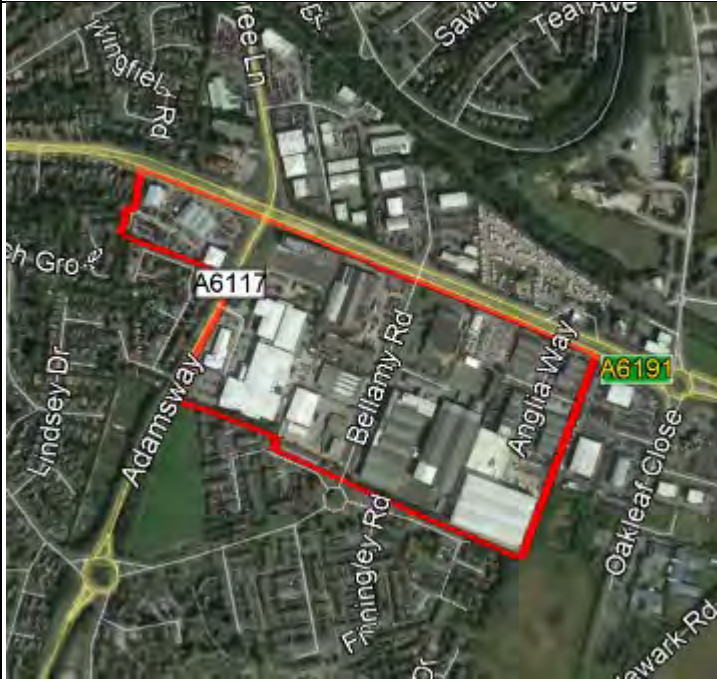

**GROSS SITE AREA:
19.54 ha**

**ESTIMATED NET DEVELOPABLE
AREA:
0 ha**

CRITERIA	COMMENT	RATING
<p>Site Context</p> <ul style="list-style-type: none"> • Location with regards to existing employment areas and other sites • How the site fits into the overall portfolio 	<p>This is a well-established industrial estate within a wider industrial area along Southwell Road West (A6191) on the south-eastern outskirts of Mansfield.</p> <p>It is adjacent to Sherwood Oaks Business Park and Oak Tree Business Park and also in close proximity to Ransom Wood Business Park and Ratcher Hill employment area.</p>	
<p>Local Plan Designation</p>	<p>The Development Plan for Mansfield comprises of the Mansfield District Local Plan 2013-2033 (Adopted September 2020). The site is designated as a Key / General Employment Area (Policy E3m).</p>	
<p>Status in SHLAA</p>	<p>The HELAA (2017) identified a site within the wider site as 'reasonable alternative' site (ref. 37); this is now occupied by a new Linney building. Another site within the wider site (ref. 138) was excluded at Stage 2 as permission for employment uses had been implemented.</p>	
<p>Planning History</p>	<p>Recent planning history includes:</p> <ul style="list-style-type: none"> • 2018/0762/FUL – Full planning application – New Warehouse (B8) Including Reception, Changing Facilities, Ancillary Office Space and Mezzanine Pick and Pack Facility. Hard and Soft Landscaping including service yard and parking for 118 vehicles – Resubmission of Planning Application • 2018/0157/FUL for (New Warehouse with Associated Facilities and Office Space, Parking and Servicing Areas) – Granted 29.01.2019 • 2014/0684/ST – Full planning application – Erection 	

	of a commercial unit for the Storage, Repair and Sales of Caravans and Motorhomes (Use classes B1, B2 and B8) – Granted 18.02.2015	
Current Use and Land Type	This is a brownfield site occupied by an industrial estate.	
Occupier Profile (if partly developed, including % of available land and levels of vacancy onsite)	<p>The site is part occupied by Linney marketing agency. There is a cluster of car salesrooms along Southwell Road West (A6191) including a Nissan and Citroen dealer on this site as well as the Pendragon Training Centre (automotive retail).</p> <p>Other occupiers of the site include Briggs Metals (scrap metal processing), Alton Cars (vehicle repairs) and Premier Self Storage. There is also The South Mansfield Christian Fellowship church located on Bellamy Road. There are a number of smaller workshop units off Anglia Way.</p> <p>At the time of the site visit (November 2020) all units appeared to be occupied.</p>	
Strategic Road Access	The site is adjacent to and accessed from Southwell Road West (A6191). The A6191 joins the A617 approximately 1km east of the site. The A6191 continues 3km North West to the A60 and Junction 28 of the M1 is 14.1km West of the site via the A617 and A38.	Average
Local Road Access	The site is accessed via Southwell Road West (A6191) to the north, Bellamy Road to the north and south, and Adamsway (A6117) to the west. The A6191 and A6117 are good, free-flowing roads with the former heading North West towards Mansfield and South East towards the B6020 (Mansfield Road) and the A617. Bellamy Road and Anglia Way branch off Southwell Road West. Bellamy Road is a smaller, predominantly residential road which also leads to residential areas.	Very Good
Proximity to Urban Areas and Access to Labour and Services (including public transport / cycling / walking accessibility)	<p>The site is located on the south-eastern outskirts of Mansfield. Mansfield town centre provides a wide range of facilities and services including schools, medical services, shops, recreational facilities and a police station.</p> <p>The residential suburb of Berry Hill is located to the west of the site. The site is also to the south of Oak Tree Lane and surrounding residential area, as well as the Tesco Extra. The site is located 2.4km North West of Rainworth village via the A6191 and B6020 which provides schools, a health centre, local shops, post office and takeaway.</p> <p>The site is serviced by regular bus services via</p>	Average / Good

	<p>stops on the A6191 travelling South East (towards Nottingham and Rainworth, and less frequent services to Newark, Blidworth, Bilsthorpe and Eakring) and North West (towards Mansfield and Sutton in Ashfield).</p> <p>Mansfield railway station is 4.5km away and is serviced by regular bus stops on the A6191. There are also bus stops on Bellamy Road.</p>	
<p>Compatibility of Adjoining Uses (including amenity impacts experienced by current/future occupiers and neighbouring areas)</p>	<p>The site is bordered by the A6191 to the north, with car salesrooms and employment uses beyond, by Sherwood Oaks Business Park to the east, by residential areas to the south and Adamsway (A6117) to the west with residential areas beyond.</p>	Average
<p>Developmental and Environmental Constraints (e.g. size; topography; site access; roads, lighting, landscaping, mains utilities and communications infrastructure; flood risk; contamination; nature and heritage conservation)</p>	<p>This is a large site with access from Southwell Road West, Adamsway and Bellamy Road, utilities and communications infrastructure are already in place.</p> <p>The site slopes gently from north to south and is within Flood Zone 1 and therefore at low risk of flooding. There are no heritage or environmental designations within or adjacent to the site.</p>	Very Good
<p>Barriers to Delivery and Mitigation (including ownership constraints - if known)</p>	<p>The site is fully developed and no other constraints to redevelopment were apparent from the site visit.</p>	Very Good
<p>Market Attractiveness (including appropriateness, vacancy and market activity on site for the type of development proposed)</p>	<p>This is a large site within the main urban area of Mansfield. It is highly visible from Southwell Road West and is occupied by a range of employment uses and has low vacancy levels. The area would benefit from investment in public realm, boundaries and landscaping to improve its kerb appeal.</p>	Good
<p>Strategic Fit with Growth Area Objectives (by target Market Segment)</p>	<p>This site already accommodates key industrial growth sectors as identified in the D2N2 Vision 2030 document including professional/business services, creative & digital and retail.</p>	Good
<p>OVERALL SITE RATING</p>	<p>Good</p>	
<p>Recommendation and Potential Future Uses</p>	<p>Protect for employment uses (i.e. retain allocation as a key / general employment area)</p>	
<p>SITE SUMMARY:</p> <p>This is a well-established industrial estate within a wider industrial area along Southwell Road West (A6191) on the south-eastern outskirts of Mansfield. The site is primarily occupied by Linney Group. There is a cluster of car salesrooms along Southwell Road West (A6191) including a Nissan and Citroen dealer on this site as well as the Pendragon Training Centre, the site has low vacancy levels. The site is designated as a key / general employment area in the Local Plan and it</p>		

is recommended that the site is protected for employment uses.

Hermitage Lane Industrial Estate (Ref: MDC11)



GROSS SITE AREA:
11.29 ha

ESTIMATED NET DEVELOPABLE AREA:
0 ha

CRITERIA	COMMENT	RATING
<p>Site Context</p> <ul style="list-style-type: none"> • Location with regards to existing employment areas and other sites • How the site fits into the overall portfolio 	<p>This is a well-established industrial estate within a wider industrial area on the south-western outskirts of Mansfield. It is adjacent to the Oakham Business Park and the new Amazon distribution centre at Summit Park is approximately 200m to the south.</p>	
<p>Local Plan Designation</p>	<p>The Development Plan for Mansfield comprises of the Mansfield District Local Plan 2013-2033 (Adopted September 2020). The site is designated as a Key / General Employment Area (Policy E3n).</p>	
<p>Status in SHLAA</p>	<p>The HELAA (2017) identified smaller sites within the site as 'reasonable alternative' consent sites (refs. 140, 212 and 215).</p>	
<p>Planning History</p>	<p>Recent planning history includes:</p> <ul style="list-style-type: none"> • 2016/0086/ST – Full planning application – Erection of 3 No. Light Industrial/Distribution Units (Use Class B1/B2/B8) – Granted 17.05.2016 • 2017/0155/FUL – Full planning application - New Light Industrial Unit – Granted 08.05.2017 • 2017/0850/FUL – Full planning application – 1 No. New Industrial Unit – Granted 22.02.2018 • 2018/0473/FUL – Full planning application – 1 No. New Attached Industrial Unit – Granted 14.08.2018 	
<p>Current Use and Land Type</p>	<p>This is a brownfield site occupied by an established industrial estate.</p>	
<p>Occupier Profile (if partly developed, including % of</p>	<p>This site is fully developed and occupied by a range of uses including:</p>	

<p>available land and levels of vacancy onsite)</p>	<p>UK Power Reserve Electricity Regeneration Plant; Abbey Trade Park – accommodating Screwfix, Travis Perkins, Tool Station, Edmundson Electrical and other homewares retailers; Tool Hire Express; Status Scientific Dynamant (scientific equipment supplier); T4 Design Glass Processors; and QRMS (recycling centre). There are a number of smaller trade units, including some relatively modern units.</p> <p>Overall, the site has good occupancy and at the time of the site visit (November 2020) there were only a few vacant units:</p> <p>A detached office/workshop unit of 363 sqm; and Three modern trade counter units which can be combined to comprise of a total of 778 sqm.</p>	
<p>Strategic Road Access</p>	<p>The A38 is approximately 500m north of the site via Hermitage Lane and the A617 is approximately 500m south of the site. The site is 1km from the A60 heading south east. The site is 9.1km from junction 28 of the M1 via the A617 and A38. The A617 and A38 are good, free-moving roads with the later providing direct access to Mansfield to the North East and Sutton-in-Ashfield to the West.</p>	<p>Poor / Average</p>
<p>Local Road Access</p>	<p>The site is accessed from east via Hermitage Lane which meets the A38 after 0.5km. Hermitage Lane access is constrained by a restricted-height railway bridge (max height 4.0m) which passes over the road approximately 200m north of the site. The A617 and A38 are good, free-moving roads with the later providing direct access to Mansfield to the North East and Sutton-in-Ashfield to the West.</p>	<p>Good</p>
<p>Proximity to Urban Areas and Access to Labour and Services (including public transport / cycling / walking accessibility)</p>	<p>The site is located on the South West outskirts of Mansfield centre which is 3.2km from the site via the A38. The town of Sutton-in-Ashfield is approximately 4km to the west of the site via the A617 and B6023.</p> <p>Mansfield and Sutton-in-Ashfield both provide a wide range of facilities and services including schools, medical services and shops. Mansfield also provides a range of recreational facilities and a police station.</p> <p>The Site is not serviced by regular public transport services, the closest regular bus services are accessed via stops on the A38 0.5km from the site. Buses from the A38 travel South/West towards Sutton-in-Ashfield, Nottingham, South</p>	<p>Good</p>

	<p>Normanton and Derby and North East towards Mansfield.</p> <p>Mansfield railway station is approximately 2.4km away and is serviced by regular buses from the A38.</p> <p>The Timberland Trail footpath adjoins the site boundary to the south and west.</p>	
<p>Compatibility of Adjoining Uses (including amenity impacts experienced by current/future occupiers and neighbouring areas)</p>	<p>The site is bordered by the East Midlands Railway line and the River Maun to the North/West with residential areas beyond to the North and greenfield land and reservoir beyond to the West. There are further industrial units bordering the site to the South and East.</p>	Very Good
<p>Developmental and Environmental Constraints (e.g. size; topography; site access; roads, lighting, landscaping, mains utilities and communications infrastructure; flood risk; contamination; nature and heritage conservation)</p>	<p>This is a large established industrial estate with access from Hermitage Lane and internal spine roads, utilities and communications infrastructure already in place.</p> <p>The site slopes gently from north to south. The majority of the site is within Flood Zone 1 and therefore at low risk of flooding, apart from a small area at the northern boundary within Flood Zone 2.</p> <p>Hermitage Mill immediately north of the site is grade II listed (ref. 1288578) and the railway bridge 100 metres west of Hermitage Mill is also grade II listed (ref. 1207169). The Hermitage Local Nature Reserve and King's Mill Viaduct scheduled monument are to the west of the site and the Oakham Local Nature Reserve is to the east of the site.</p>	Good
<p>Barriers to Delivery and Mitigation (including ownership constraints - if known)</p>	<p>The site is fully developed and no other barriers to redevelopment were evident from the site visit.</p>	Good
<p>Market Attractiveness (including appropriateness, vacancy and market activity on site for the type of development proposed)</p>	<p>This is a large site within the main urban area of Mansfield. It is occupied by a range of employment uses and has low vacancy levels. The area would benefit from investment in public realm, boundaries and landscaping.</p>	Average
<p>Strategic Fit with Growth Area Objectives (by target Market Segment)</p>	<p>This site already accommodates key industrial growth sectors as identified in the D2N2 Vision 2030 document including construction and retail.</p>	Average
<p>OVERALL SITE RATING</p>	<p>Good</p>	
<p>Recommendation and Potential Future Uses</p>	<p>Protect for employment uses (i.e. retain allocation as a key / general employment area)</p>	

SITE SUMMARY:

This is a well-established industrial estate within the Mansfield urban area, to the south of the town centre and within the wider Hamilton Way/Hermitage Lane industrial area. It is primarily occupied by construction industries, and trade counters. The site would benefit from improvements to bus services and investment in public realm. The site is designated as a key / general employment area in the Local Plan and it is recommended that the site is protected for employment uses.

Maunside, Hermitage Lane (Ref: MDC12)



**GROSS SITE AREA:
9.84 ha**

**ESTIMATED NET DEVELOPABLE
AREA:
0 ha**

CRITERIA	COMMENT	RATING
<p>Site Context</p> <ul style="list-style-type: none"> • Location with regards to existing employment areas and other sites • How the site fits into the overall portfolio 	<p>This is a well-established industrial estate within a wider industrial area on the south-western outskirts of Mansfield. It is adjacent to Oakham Business Park and the new Amazon distribution centre at Summit Park is approximately 200m to the south.</p>	
<p>Local Plan Designation</p>	<p>The Development Plan for Mansfield comprises of the Mansfield District Local Plan 2013-2033 (Adopted September 2020). The site is designated as a Key / General Employment Area (Policy E3o).</p>	
<p>Status in SHLAA</p>	<p>The HELAA (2017) identified the site as a 'reasonable alternative' consent site (ref. 123).</p>	
<p>Planning History</p>	<p>Recent planning history relates to the employment uses onsite.</p>	
<p>Current Use and Land Type</p>	<p>This is a brownfield site occupied by an established industrial estate.</p>	
<p>Occupier Profile (if partly developed, including % of available land and levels of vacancy onsite)</p>	<p>This site is fully developed and occupied by a range of B2/B8 units, smaller trade units and offices as well as waste and recycling centres.</p> <p>Occupiers include:</p> <p>Mansfield District Council Trade Waste Services Hermitage Lane Depot Mansfield Household Recycling Centre Greenline Industrial Estate – occupiers include Protrade</p>	

	<p>Depot, Crown Paints, Craft Signs, Virgin Media, Autoglass, Wolseley Willbond Plumbing Centre Booker Wholesale Cash and Carry Polyframe Trade Doors Mitchells Ironmongers Mansfield Tyres Webeye Limited (CCTV supplier) Peaceful Trust (Charity shop)</p> <p>At the time of the site visit (November 2020) all units appeared to be occupied.</p>	
Strategic Road Access	<p>The A38 is approximately 500m north of the site via Hermitage Lane and the A617 is approximately 500m south of the site. The site is 1km from the A60 heading south east. The site is 9.1km from junction 28 of the M1 via the A617 and A38. The A617 and A38 are good, free-moving roads with the later providing direct access to Mansfield to the North East and Sutton-in-Ashfield to the West.</p>	Poor / Average
Local Road Access	<p>The site is accessed from the west via Hermitage Lane which meets the A38 after 0.5km. Hermitage Lane access is constrained by a restricted-height railway bridge (max height 4.0m) which passes over the road approximately 200m north of the site. The A617 and A38 are good, free-moving roads with the later providing direct access to Mansfield to the North East and Sutton-in-Ashfield to the West. The site has multiple internal spine roads – Maunside, Melton Way and Kestral Road.</p>	Good
Proximity to Urban Areas and Access to Labour and Services (including public transport / cycling / walking accessibility)	<p>The site is located on the South West outskirts of Mansfield centre which is 3.2km from the site via the A38. The town of Sutton-in-Ashfield is approximately 4km to the west of the site via the A617 and B6023. Mansfield and Sutton-in-Ashfield both provide a wide range of facilities and services including schools, medical services and shops. Mansfield also provides a range of recreational facilities and a police station.</p> <p>The site is not serviced by regular public transport services, the closest regular bus services are accessed via stops on the A38 0.5km from the site. Buses from the A38 travel South/West towards Sutton-in-Ashfield, Nottingham, South Normanton and Derby and North East towards Mansfield.</p> <p>Mansfield railway station is approximately 2.4km</p>	Good

	<p>away and is serviced by regular buses from the A38.</p> <p>The Timberland Trail footpath adjoins the site boundary to the south.</p>	
<p>Compatibility of Adjoining Uses (including amenity impacts experienced by current/future occupiers and neighbouring areas)</p>	<p>The site is bordered to the North by the Oakham Local Nature Reserve with the River Maun and Mansfield concrete plant beyond, and further industrial units to the South, East and West.</p>	Very Good
<p>Developmental and Environmental Constraints (e.g. size; topography; site access; roads, lighting, landscaping, mains utilities and communications infrastructure; flood risk; contamination; nature and heritage conservation)</p>	<p>This is a large established industrial estate with access from Hermitage Lane and internal spine roads, utilities and communications infrastructure already in place.</p> <p>The site slopes gently from north to south. The majority of the site is within Flood Zone 1 and therefore at low risk of flooding. However, there is a small area off Maun Way within Flood Zones 2 and 3.</p> <p>The Oakham Local Nature Reserve bounds the site to the north. Hermitage Mill immediately west of the site is grade II listed (ref. 1288578). The railway bridge 100 metres west of Hermitage Mill is also grade II listed (ref. 1207169). The Hermitage Local Nature Reserve and King's Mill Viaduct scheduled monument are within 500m of the site. Matlock Mill Joinery works is approximately 250m east of the site and is grade II listed (ref. 1279862).</p>	Average
<p>Barriers to Delivery and Mitigation (including ownership constraints - if known)</p>	<p>The site is fully developed and no other barriers to redevelopment were evident from the site visit.</p>	Average
<p>Market Attractiveness (including appropriateness, vacancy and market activity on site for the type of development proposed)</p>	<p>This is a large site within the main urban area of Mansfield. It is occupied by a range of employment uses and has low vacancy levels.</p>	Average
<p>Strategic Fit with Growth Area Objectives (by target Market Segment)</p>	<p>This site already accommodates key industrial growth sectors as identified in the D2N2 Vision 2030 document including construction, professional/business services and retail.</p>	Average
<p>OVERALL SITE RATING</p>	<p>Good</p>	
<p>Recommendation and Potential Future Uses</p>	<p>Protect for employment uses (i.e. retain allocation as a key / general employment area)</p>	
<p>SITE SUMMARY:</p>		

This is a well-established industrial estate within a wider industrial area on the south-western outskirts of Mansfield. It is adjacent to Oakham Business Park and the new Amazon distribution centre at Summit Park is approximately 200m to the south. The site has low vacancy levels and accommodates key industrial growth sectors including construction, professional/business services and retail. There are also recycling and waste depots and a charity shop on the site. The site would benefit from improvements to bus services and investment in public realm. The site is designated as a key / general employment area in the Local Plan and it is recommended that the site is protected for employment uses.

Ratcher Hill Employment Area and Quarry (Ref: MDC13)



**GROSS SITE AREA:
7.25 ha**

**ESTIMATED NET DEVELOPABLE AREA:
3.45 ha**

CRITERIA	COMMENT	RATING
<p>Site Context</p> <ul style="list-style-type: none"> • Location with regards to existing employment areas and other sites • How the site fits into the overall portfolio 	<p>This site comprises of the existing Ratcher Hill Employment Area to the south and the allocated extension to the north. To the south there are a couple of detached office buildings adjacent to the A6191, the former NHS Mansfield and Ashfield CCG Birch House Offices to the east, a storage compound and a former under 17s driving area and the Breedon Mansfield Asphalt Plant to the north.</p> <p>The site is within a wider industrial area along Southwell Road West (A6191) on the south-eastern outskirts of Mansfield. It is adjacent to the Ransom Wood Business Park and Oak Tree Business Park, and in close proximity to the Sherwood Oaks Business Park, and Bellamy Road Industrial Estate.</p>	
<p>Local Plan Designation</p>	<p>The Development Plan for Mansfield comprises of the Mansfield District Local Plan 2013-2033 (Adopted September 2020). The Ratcher Hill Employment Area to the south is designated as a Key / General Employment Area (Policy E3s).</p> <p>The land occupied by the Breedon Mansfield Asphalt Plant to the north is designated as a new employment area – Ratcher Hill Quarry Employment Area (Policy E2a), a 3.45 ha extension to the Ratcher Hill Employment Area for office, warehousing and industrial development.</p>	
<p>Status in SHLAA</p>	<p>The HELAA (2017) identified the land to the north of the former NHS Birch House offices as a ‘reasonable alternative’ site (site ref. 38 comprising of 2.07 ha). The site is understood to be available for development and car park proposals would comprise 0.61 ha; however, land stability issues may restrict development of the remaining site area.</p>	

	<p>The HELAA also identified land south of the driving track (site ref. 151) comprising of 0.22 ha of carparking. However, the landowners indicated the site was no longer available and it was excluded at Stage 2.</p>	
Planning History	<p>Recent planning applications include:</p> <ul style="list-style-type: none"> • 2019/0445/COU - Mills Extreme Vehicles Ratcher Hill - Change of use from workshop (B1, B2 AND B3 use) to gymnastics centre (D2 use) – Granted 06.11.2019 • This application is outside the site boundary but immediately adjacent to the south-east: 2019/0019/FUL - Vacant Plot Of Land To The South Of Ransom Wood, Northeast Of The Roundabout At A6191 And Sherwood Avenue - the erection of four buildings comprising 2no. Restaurant / drive-thrus (class A3/A5); a restaurant (class A3); and a vehicle rental unit (sui generis) with associated vehicular access, parking, servicing, landscaping and associated works. - resubmission. – Granted 03.07.2020 	
Current Use and Land Type	<p>This is a brownfield site occupied by office buildings, storage land, a former driving practice track and an Asphalt Plant.</p>	
Occupier Profile (if partly developed, including % of available land and levels of vacancy onsite)	<p>Occupiers include the Breedon Mansfield Asphalt Plant, Persimmon Homes Nottingham Office, a storage compound and a former under 17s driving area.</p> <p>At the time of the site visit (November 2020) there was an office to let – Fountain House first floor comprising of 500sqm. The former driving practice track site was also available, it comprises of 1.64 ha of land suitable for vehicle storage or other employment uses subject to planning. Since the site visit, it is understood that the NHS Mansfield and Ashfield CCG Birch House Offices have also become vacant.</p>	
Strategic Road Access	<p>The site is accessed via the A6191 to the South. The A6191 continues 3.4km North West to the A60 and Junction 28 of the M1 is 15.2km West of the site via the A617 and A38.</p>	Average
Local Road Access	<p>The site can be accessed via the A6191 which is a good free-moving road heading North West towards Mansfield and South East towards the B6020 (Mansfield Road) and the A617. The B6020 continues South East towards Rainworth. The A617 continues East towards Newark-on-Trent and West towards Sutton-in-Ashfield.</p>	Very Good
Proximity to Urban Areas and Access to Labour and Services (including public transport / cycling / walking accessibility)	<p>The site is located on the south-eastern periphery of Mansfield. Mansfield town centre provides a wide range of facilities and services including schools, medical services, shops, recreational facilities and a police station. Mansfield railway station is 5.3km away and is serviced by regular</p>	

	<p>buses from the A6191 and A6117.</p> <p>The site is 2km North West of Rainworth village via the A6191 and B6020 which provides schools, a health centre, local shops, post office and takeaway.</p> <p>The Site is serviced by regular bus services via stops on the A6191 travelling South East (towards Nottingham and Rainworth, and less frequent services to Newark, Blidworth, Bilsthorpe and Eakring) and North West (towards Mansfield and Sutton in Ashfield).</p>	
<p>Compatibility of Adjoining Uses (including amenity impacts experienced by current/future occupiers and neighbouring areas)</p>	<p>The site is bordered to the North by the wider Ratcher Hill quarry site and Jubilee Way South and residential/commercial areas, to the East by Ransom Wood Business Park, to the South by the A6191, to the West by a caravan storage park.</p>	Good
<p>Developmental and Environmental Constraints (e.g. size; topography; site access; roads, lighting, landscaping, mains utilities and communications infrastructure; flood risk; contamination; nature and heritage conservation)</p>	<p>This site comprises of an Asphalt Plant to the north with employment and leisure uses to the south with utilities and communications infrastructure in place. There are significant level changes in the northern area of the site and potential ground stability and contaminated land issues.</p> <p>The site is accessed via internal spine roads from the A6191.</p> <p>The site is within Flood Zone 1 and therefore at low risk of flooding. There are no heritage designations within or in close proximity to the site.</p> <p>Strawberry Hill Heaths SSSI and Oak Tree Heath Local Nature Reserve are within 750m of the site to the north.</p>	Poor
<p>Barriers to Delivery and Mitigation (including ownership constraints - if known)</p>	<p>There may be some ground stability / contaminated land issues associated with the quarry immediately north of the site limiting the area available for redevelopment.</p> <p>Land to the north of the former NHS Birch House comprising of 2.07 ha is understood to be available for development; however, land stability issues may restrict development of the remaining site area to 0.61 ha.</p> <p>In addition, a small area (0.22ha comprising of carparking) was identified in the HELAA however, the landowners indicated the site was no longer available.</p> <p>The former driving track was on the market at the</p>	Average / Poor

	time of the site visit, advertised for vehicle storage uses and has potential for redevelopment.	
Market Attractiveness (including appropriateness, vacancy and market activity on site for the type of development proposed)	This site is adjacent to the A6191 and the successful Ransom Wood Business Park. It is an important employment area in a high-profile location. Vacancy levels were low at the time of the site visit. The site would benefit from investment in public realm particularly near its interface with the existing quarry.	Average
Strategic Fit with Growth Area Objectives (by target Market Segment)	This site already accommodates key industrial growth sectors as identified in the D2N2 Vision 2030 document including extractive industries, professional/business services, and healthcare.	Average
OVERALL SITE RATING	Average	
Recommendation and Potential Future Uses	Allocate for employment uses (i.e. retain allocation for key / general employment area to the south, and Ratcher Hill Quarry Employment Area (Policy E2a) to the north east)	
SITE SUMMARY:		
<p>This site comprises of the existing Ratcher Hill Employment Area to the south and the allocated extension to the north. To the south there are a couple of detached office buildings adjacent to the A6191, the former NHS Mansfield and Ashfield CCG Birch House Offices to the east, a storage compound, a former under 17's driving area and the Breedon Mansfield Asphalt Plant. At the time of the site visit an office unit and the former driving practice track were on the market. Since then, the Birch House offices have also become vacant. The former driving track and land to the north of Birch House offices have potential for redevelopment subject assessing ground stability. The site would benefit from investment in public realm particularly near its interface with the existing quarry. The southern portion of the site is designated as a key / general employment area and the land currently in use by Breedon Mansfield Asphalt Plant to the north is designated as a new employment area (E2a). It is recommended that the site is allocated for employment uses.</p>		

Bleaks Hill (Ref: MDC14)



GROSS SITE AREA:
6.08 ha

ESTIMATED NET DEVELOPABLE AREA:
0 ha

CRITERIA	COMMENT	RATING
<p>Site Context</p> <ul style="list-style-type: none"> • Location with regards to existing employment areas and other sites • How the site fits into the overall portfolio 	<p>This is an existing employment site within the Mansfield urban area and to the south-west of the town centre. It is adjacent to the Hamilton Way / Hermitage Lane industrial area.</p>	
<p>Local Plan Designation</p>	<p>The Development Plan for Mansfield comprises of the Mansfield District Local Plan 2013-2033 (Adopted September 2020). The site is designated as a Key / General Employment Area (Policy E3t).</p>	
<p>Status in SHLAA</p>	<p>N/A</p>	
<p>Planning History</p>	<p>Recent applications include:</p> <ul style="list-style-type: none"> • 2019/0320/COU - Change of use of storage units (use class B8) to dog day care (use class sui generis) at Unit 3, 4 And 6 Halls Work Space Hermitage Lane. • 2019/0324/FUL - Demolish existing building and erect two storey building for storage (use class B8) and offices (use class B1a) at Land At Bleak Hill Sidings • 2018/0449/NCC - Variation of condition 2 of planning permission ref 2/2011/0307/ST to erect a new storage bay for construction waste on same footprint. Full planning permission for new wash down area and drainage at A B Waste Disposal Limited Bleak Hill Sidings. • 2017/0261/NCC - Town and Country Planning (development management procedure) (England) Order 2015 - notice under article 18 consultation on planning application - proposed replacement facilities cabin, 	

	providing office accommodation, wc and restroom at A B Waste Disposal Limited Bleak Hill Sidings.	
Current Use and Land Type	This is a brownfield site occupied by employment uses.	
Occupier Profile (if partly developed, including % of available land and levels of vacancy onsite)	<p>This site is fully developed and occupied by:</p> <p>Cemex Mansfield Concrete Plant Environmental Coatings (construction) Cash & Carry Windows Trade Counter Wernick Hire (portable building manufacturer) WH Paint Finishers Ltd AB Waste Disposal (skip hire) AS Plant Limited (civil engineering and groundworks) Intex Facades (siding contractor) H Mills & Sons (electrician) 100vans.com salesroom J&S Trade Car Centre Mansfield Doggy Day Care</p> <p>All the units appeared to be occupied at the time of the site visit (November 2020).</p> <p>This a poor-quality employment area, which nevertheless serves an important role in providing 'bad neighbour' space for uses such as recycling and concrete mixing/ open storage.</p>	
Strategic Road Access	The A38 is approximately 500m north of the site via Hermitage Lane and Sheepbridge Lane. The site is 1km from the A60 heading North East and 1km from the A617 heading South West. The site is 10km from junction 28 of the M1 via the A617 and A38. The A617 and A38 are good, free-moving roads with the later providing direct access to Mansfield to the North East and Sutton-in-Ashfield to the West.	Poor
Local Road Access	<p>The site is accessed from the North East via Sheepbridge Lane, and from the West via Hermitage Lane. Access arrangements to the site are poor from Sheepbridge Lane with unmade roads. Sheepbridge Lane access is constrained by a restricted-height railway bridge (max height 3.3m) which passes over the road approximately 0.1km from the site. The turning into the site from Sheepbridge Lane is difficult.</p> <p>Hermitage Lane access is also constrained by a restricted-height railway bridge (max height 4.0m) which passes over the road approximately 0.2km from the site.</p>	Poor
Proximity to Urban Areas and	The site is located on the South West outskirts of	Average

<p>Access to Labour and Services (including public transport / cycling / walking accessibility)</p>	<p>Mansfield centre which is 2.4km from the site via the A38. The town of Sutton-in-Ashfield is approximately 4.2km to the west of the site via the A38 and B6023.</p> <p>Mansfield and Sutton-in-Ashfield both provide a wide range of facilities and services including schools, medical services and shops. Mansfield also provides a range of recreational facilities and a police station.</p> <p>The site is not serviced by regular public transport services, the closest regular bus services are accessed via stops on the A38 which is 0.5km from the site. Buses from the A38 travel South/West towards Sutton-in-Ashfield, Nottingham, South Normanton and Derby and North East towards Mansfield.</p> <p>Mansfield railway station is approximately 2km away and is serviced by regular buses from the A38.</p>	
<p>Compatibility of Adjoining Uses (including amenity impacts experienced by current/future occupiers and neighbouring areas)</p>	<p>The site is bordered by the East Midlands Railway line to the North with residential areas beyond, to the east by Sheepsbridge Lane with allotments beyond, to the south by the River Maun and Hamilton Local Nature Reserve with the Hermitage Lane / Hamilton Way industrial area beyond and to the west by Hermitage Lane.</p>	Average
<p>Developmental and Environmental Constraints (e.g. size; topography; site access; roads, lighting, landscaping, mains utilities and communications infrastructure; flood risk; contamination; nature and heritage conservation)</p>	<p>This is a small employment site with existing utilities and communications infrastructure. The site slopes up to the north and is bound by the railway line to the north and the River Maun with the Oakham Local Nature Reserve beyond to the south.</p> <p>The site is within Flood Zone 1 and therefore at low risk of flooding. A small section at the south west corner of the area lies within Flood Zone 3.</p> <p>Matlock Mill Joinery Works immediately east of the site is Grade II listed (ref. 1279862) and Hermitage Mill immediately west of the site is grade II listed (ref. 1288578). The railway bridge 100 metres west of Hermitage Mill is also grade II listed (ref. 1207169). The Hermitage Local Nature Reserve and King's Mill Viaduct scheduled monument are within 500m of the site.</p>	Average
<p>Barriers to Delivery and Mitigation (including ownership constraints - if known)</p>	<p>The site is fully developed and no other barriers to redevelopment were evident from the site visit.</p>	Average
<p>Market Attractiveness (including appropriateness, vacancy)</p>	<p>This is a small site within the main urban area of Mansfield. It is occupied by a range of</p>	Average

and market activity on site for the type of development proposed)	employment uses and has low vacancy levels. It is a poor-quality employment area which nevertheless fulfils an important local role.	
Strategic Fit with Growth Area Objectives (by target Market Segment)	This site already accommodates key industrial growth sectors as identified in the D2N2 Vision 2030 document including construction.	Average
OVERALL SITE RATING	Average	
Recommendation and Potential Future Uses	Protect for employment uses (i.e. retain allocation as a key / general employment area).	
SITE SUMMARY:		
<p>This is an existing employment site within the Mansfield urban area, to the south of the town centre and adjacent to the Hamilton Way/Hermitage Lane industrial area. It is primarily occupied by construction industries, car sales showrooms and a doggy day care centre. The overall quality of the estate is poor owing to the nature of the uses. The area would benefit from investment in public realm, formation of roads and landscaping. The site is designated as a key / general employment area in the Local Plan and it is recommended that the site is protected for employment uses.</p>		

Quarry Lane (Ref: MDC15)



GROSS SITE AREA:
4.62 ha

ESTIMATED NET DEVELOPABLE AREA:
0 ha

CRITERIA	COMMENT	RATING
<p>Site Context</p> <ul style="list-style-type: none"> • Location with regards to existing employment areas and other sites • How the site fits into the overall portfolio 	<p>This is an existing employment site within the Mansfield urban area and to the south of the town centre. It is approximately 500m north of the Hamilton Way industrial area.</p>	
<p>Local Plan Designation</p>	<p>The Development Plan for Mansfield comprises of the Mansfield District Local Plan 2013-2033 (Adopted September 2020). The site is designated as a Key / General Employment Area (Policy E3u).</p>	
<p>Status in SHLAA</p>	<p>N/A</p>	
<p>Planning History</p>	<p>2019/0153/FUL - Extensions and alterations to existing workshop including provision for additional staff welfare facilities and additional car parking – Granted with conditions 20.06.0219</p>	
<p>Current Use and Land Type</p>	<p>This is a brownfield site occupied by employment uses.</p>	
<p>Occupier Profile (if partly developed, including % of available land and levels of vacancy onsite)</p>	<p>This site is fully developed and primarily occupied by SDC Trailers (trailer manufacturer). There are a number of smaller workshops off Highfield Way and Broader Way accommodating a range of construction, engineering, manufacturing and vehicle servicing uses. All the units appeared to be occupied at the time of the site visit (November 2020).</p>	
<p>Strategic Road Access</p>	<p>The site is approximately 500m from the A60 and 1km from the A38. It is approximately 10.3km</p>	<p>Poor</p>

	from junction 28 of the M1 via the A617 and A38.	
Local Road Access	The site is accessed via Quarry Lane. Quarry Lane is easily accessible from the North East end via the A60, however, access from the South West end via Sheepbridge Lane is constricted by a restricted-height railway bridge (max height 4.8m and only passable by one vehicle at a time) which passes over the road to the South of the site. When approaching Quarry Lane via the A38, access is again constrained by another restricted-height railway bridge (max height 3.3m) on Sheepbridge Lane approximately 06.km from the site.	Poor
Proximity to Urban Areas and Access to Labour and Services (including public transport / cycling / walking accessibility)	The site is located towards the South West outskirts of Mansfield centre which is 2km from the site via the A60. Mansfield provides a wide range of facilities and services including schools, medical services, shops, a range of recreational facilities and a police station. The Site is not serviced by regular public transport services; the closest regular bus services are accessed via stops on the A60 which is 0.5 km from the site. Buses from the A60 travel North towards Mansfield and South towards Nottingham, Berry Hill and Forest Town. Mansfield railway station is approximately 1km away and is serviced by regular buses from the A60.	Average
Compatibility of Adjoining Uses (including amenity impacts experienced by current/future occupiers and neighbouring areas)	The site is bordered by Mansfield Town Football Club and Portland Retail Park to the East, the East Midlands Railway to the North, Quarry Lane with the River Maun and Quarry Lane Nature Reserve beyond to the South and the railway line and Moor Lane Park/allotment land to the West.	Good
Developmental and Environmental Constraints (e.g. size; topography; site access; roads, lighting, landscaping, mains utilities and communications infrastructure; flood risk; contamination; nature and heritage conservation)	This is a small employment site with existing utilities and communications infrastructure. The site slopes up to the north and is bound by the railway line to the north and west and the River Maun with the Quarry Lane Nature Reserve beyond to the south. Drury Dam Viaduct immediately south of the site is grade II listed (ref. 1207187). The site is within Flood Zone 1 and therefore at low risk of flooding.	Average
Barriers to Delivery and Mitigation	The site is fully developed and no other barriers to redevelopment were evident from the site visit.	Good

(including ownership constraints - if known)		
Market Attractiveness (including appropriateness, vacancy and market activity on site for the type of development proposed)	This is a small site in a good central location within the main urban area of Mansfield. It is occupied by a range of employment uses and has low vacancy levels but is in need of some repair and maintenance to improve its kerb appeal.	Average
Strategic Fit with Growth Area Objectives (by target Market Segment)	This site already accommodates key industrial growth sectors as identified in the D2N2 Vision 2030 document including transport equipment manufacturing.	Average
OVERALL SITE RATING	Average	
Recommendation and Potential Future Uses	Protect for employment uses (i.e. retain allocation as a key / general employment area)	
SITE SUMMARY:		
<p>This is an existing employment site within the Mansfield urban area, to the south of the town centre and approximately 500m north of the Hamilton Way industrial area. It is primarily occupied by a trailer manufacturer and a number of smaller workshop units. This is a small site in a good central location with low vacancy levels but is in need of some repair and maintenance. The site is designated as a key / general employment area in the Local Plan and it is recommended that the site is protected for employment uses.</p>		

Penniment Farm (Ref: MDC16)

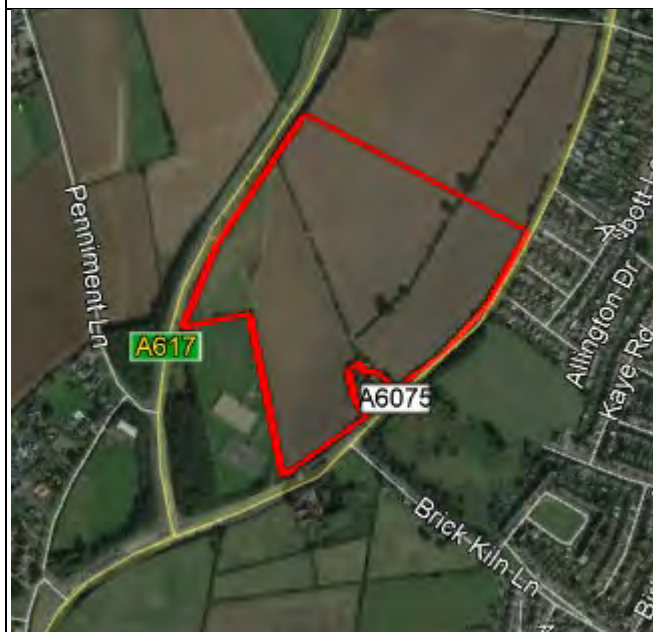

**GROSS SITE AREA:
12.72 ha**

**ESTIMATED NET DEVELOPABLE AREA:
9 ha**

(Note: The allocation is for a minimum of 9ha)

CRITERIA	COMMENT	RATING
<p>Site Context</p> <ul style="list-style-type: none"> • Location with regards to existing employment areas and other sites • How the site fits into the overall portfolio 	<p>This is a greenfield site to the west of Mansfield. It is part of a wider development (permission ref. 2010/0805/ST) for up to 430 homes, 39,216 sqm employment space and 84sqm of retail space. The first phase is being delivered by Persimmon to the south of Water Lane.</p>	
<p>Local Plan Designation</p>	<p>The Development Plan for Mansfield comprises of the Mansfield District Local Plan 2013-2033 (Adopted September 2020). The site is allocated for Employment (E2c). Policy E2c Penniment Farm allocates the site for a minimum of 9 hectares of employment uses and with direct access from the Mansfield and Ashfield Regeneration Route (MARR).</p> <p>The wider site to the north is allocated for Housing (H2).</p>	
<p>Status in SHLAA</p>	<p>The HELAA (2017) identified the site (ref. 82) as a 'reasonable alternative' consented site.</p>	
<p>Planning History</p>	<p>Recent planning applications include:</p> <ul style="list-style-type: none"> • 2010/0805/ST - Outline planning application (including the reserved matter of access) for mixed use development comprising housing (maximum 430 units) & employment (use classes b1, b2 and b8 - up to 39,216 sqm) retail (use class a1 - up to 84 sqm), open space, landscaping, access and infrastructure works – Granted with conditions 12.12.2012 This includes the appraisal site and land to the north. • 2017/0572/RES - Approval of reserved matters for the erection of 202 no. Residential (c3) dwellings including details for the layout, appearance, scale and landscaping 	

	<p>on outline planning application - 2010/0805/ST (outline application including the reserved matter of access for mixed use development comprising housing (maximum 430 units) and employment (use classes b1, b2 and b8 - up to 39,216 sqm) retail (class a1) up to 84 sqm, open space, landscaping, access and infrastructure works. – Granted with conditions 12.02.2018 This is Phase 1 of the wider development and is being brought forward by Persimmon. It is located in the north-eastern corner of the wider site.</p> <ul style="list-style-type: none"> • 2015/0502/ST - Application for the approval of the reserved matters of access, appearance, landscaping, layout and scale of phase 1 junction works to water lane following outline planning permission for mixed use development comprising housing (maximum 430 units) & employment (use classes b1, b2 and b8 - up to 39,216 sq m) retail (use class a1 - up to 84 sq m) (2010/0805/ST) – Grant approval 10.12.2015 • 2018/0791/RES - Approval of reserved matters on planning permission 2010/0805/ST (outline planning application (including the reserved matter of access) for mixed use development comprising housing (maximum 430 units) & employment (use classes b1, b2 and b8 - up to 39,216 sq m) retail (use class a1 - up to 84 sq m), open space, landscaping, access and infrastructure works) for appearance, landscaping, layout and scale for 220 residential dwellings only – Pending – Validated 10.12.2018 • 2018/0790/RES - Approval of reserved matters application for appearance, landscaping, layout and scale for the spine road on outline application 2010/0805/ST – Pending – Validated 10.12.2018 • There has also been non-material amendment, discharge of conditions and diversion of footpath applications in relation to development of the wider site. 	
Current Use and Land Type	This is a greenfield site in agricultural use.	
Occupier Profile (if partly developed, including % of available land and levels of vacancy onsite)	N/A – this is a vacant greenfield site.	
Strategic Road Access	The site is adjacent to the A617 but is 10 km from junction 29 of the M1 via the A617.	Average
Local Road Access	The site is bordered by the A617 to the West and North and the A6075 to the South and East. Both are good, free-flowing roads with the A617 continuing North onto the M1 and the A60785 continuing East to the town of Mansfield Woodhouse. There is a gate and track access to the site from the A617 to the north.	Good

<p>Proximity to Urban Areas and Access to Labour and Services (including public transport / cycling / walking accessibility)</p>	<p>The site is located on the western periphery of Mansfield, to the North East of Skegby and to the North of Sutton-in-Ashfield via the A6075. Mansfield town centre (approximately 3.8km from the site) provides a wide range of facilities and services including schools, medical services, shops, recreational facilities, police station and railway station. Infrequent bus services from the A6075 adjoining the site service Mansfield town centre and railway station, Bull Farm, Ladybrook and Kirkby in Ashfield.</p>	<p>Average</p>
<p>Compatibility of Adjoining Uses (including amenity impacts experienced by current/future occupiers and neighbouring areas)</p>	<p>The site is bordered by the A617 to the West and North with greenfield land beyond. The A6075 borders the site to the South and East with residential areas and greenfield land beyond. There are a couple of covered reservoirs adjacent to the site to the South-West.</p>	<p>Average</p>
<p>Developmental and Environmental Constraints (e.g. size; topography; site access; roads, lighting, landscaping, mains utilities and communications infrastructure; flood risk; contamination; nature and heritage conservation)</p>	<p>This is a relatively level greenfield site with a gated track access from the A617. Hedgerows intersect and demarcate the site. A footpath also intersects the site from east to west. The site is within Flood Zone 1 and therefore at a relatively low risk of flooding.</p> <p>There are two listed buildings within 400m north-west of the site: Penniment Lodge Farm (ref. 1096124) and Barn at Penniment Lodge Farm (ref. 1096123).</p>	<p>Good</p>
<p>Barriers to Delivery and Mitigation (including ownership constraints - if known)</p>	<p>The infrastructure requirements have been considered as part of the planning applications. No other barriers to delivery were evident from the site visit.</p>	<p>Very Good</p>
<p>Market Attractiveness (including appropriateness, vacancy and market activity on site for the type of development proposed)</p>	<p>This is a highly visible site on the outskirts of Mansfield with a new access from the MARR proposed. The site is likely to be attractive to a variety of employment uses.</p>	<p>Good</p>
<p>Strategic Fit with Growth Area Objectives (by target Market Segment)</p>	<p>This site has potential to accommodate key industrial growth sectors as identified in the D2N2 Vision 2030 document.</p>	<p>Good</p>
<p>OVERALL SITE RATING</p>	<p>Good</p>	
<p>Recommendation and Potential Future Uses</p>	<p>Allocate for employment uses (i.e. retain allocation for employment uses)</p>	
<p>SITE SUMMARY:</p>		
<p>This is a greenfield site to west of Mansfield. The site is allocated for employment uses - a</p>		

minimum of 9 ha and with direct access from the Mansfield and Ashfield Regeneration Route (MARR). Land to the north is allocated for housing. The site is within the wider site, including land to the north, granted outline permission for up to 430 homes, 39,216 sqm employment space and 84sqm of retail space. The first phase, to the south of Water Lane, is being delivered by Persimmon. It is recommended that the that the site is allocated for employment uses.

Old Mill Lane Industrial Estate (Ref: MDC1)



GROSS SITE AREA:
20.03 ha

ESTIMATED NET DEVELOPABLE AREA:
0 ha

CRITERIA	COMMENT	RATING
<p>Site Context</p> <ul style="list-style-type: none"> • Location with regards to existing employment areas and other sites • How the site fits into the overall portfolio 	<p>This is a successful and popular industrial estate on the northern periphery of Mansfield. The employment uses have been diluted by a range of other uses including a supermarket, bakery, leisure uses and a range of homewares/DIY shops.</p> <p>It is located 2.5 km west of the Crown Farm Way Industrial Estate, 1.6 km south of the Grove Way, Mansfield Woodhouse employment area, 3 km east of the Millennium Business Park and 2 km north of the Broadway Industrial Estate.</p>	
<p>Local Plan Designation</p>	<p>The Development Plan for Mansfield comprises of the Mansfield District Local Plan 2013-2033 (Adopted September 2020). The site is designated as a Key / General Employment Area (Policy E3a).</p>	
<p>Status in SHLAA</p>	<p>The Housing and Economic Land Availability Assessment (HELAA) (2017) identified a number of smaller areas within the site as follows:</p> <ul style="list-style-type: none"> • Site ref. 121 – Rippon Homes Building – 0.66ha – Excluded at Stage 2. This is now occupied by a new Lidl supermarket. • Site ref. 200 – Land to the rear of Grove Motors Units 1-2 Hallamway – 0.12 ha – Permission Granted, Reasonable Alternative. This is now occupied by Millwood Timber. • Site ref. 213 – Land between Hallamway and Units 1-3 Old Mill Lane – 1 ha – Permission Granted, Reasonable Alternative. This is now occupied by Screwfix, Greggs, Bubbles Bathrooms, ERF Electrical Wholesaler and a Volvo car service centre. 	

<p>Planning History</p>	<p>Recent planning history includes:</p> <ul style="list-style-type: none"> • 2020/0083/FUL – Full planning application – First Floor Extension to Offices – Granted 31.03.2020 • 2019/0716/NMA – Non-material amendment – Non-material amendment to Condition 7 on Planning – Application 2018/0702/FUL to delete words ‘And Bank Holiday’ from the Condition wording – Granted 19.11.2019 • 2018/0684/ADV – Advertisement Consent – Signage in the form of 2 No. Double Sided Externally illuminated totems – Granted 12.12.2018 • 2018/0702/FUL – Full planning application – Proposed retail supermarket with associated access, car parking and servicing – Granted 18.10.2019 • 2018/0820/FUL – Full planning application – Single Storey Extension for Office Use and Showroom – Granted 07.02.2019 • 2017/0598/PNSDM – Demolition of the former Rippons Homes Building, associated commercial unit and 2 No. Residential properties, and associated works – Granted 17.10.2017 • 2017/0066/FUL – Full planning application – Construction of 3 No. Industrial Units with B2 use, including vehicle access – Granted 23.03.2017 • 2017/0782/FUL – Full planning application – Single Storey Extension including warehouse extension, plant store and associated works – Granted 17.01.2018 • 2016/0137/NT – Full planning application - Creation of 3 No. New Trade Units Comprising 1 No. For B8 Use with Trade Counter, 2 No. For A1 (Convenience/Food A5, B1 and B8, and associated pick up point and car parking on existing industrial estate. Relocation of the existing site entrance to a new site entrance – Refused 17.03.2017 • 2016/0611/NT – Change of use – Change of use application - Change of use from A1 (Shops) to Use Class D2 (Assembly and Leisure) – Granted 20.12.2016 • 2016/0320/NT – Full planning application - Proposed extension – Granted 29.09.2016
<p>Current Use and Land Type</p>	<p>This is a brownfield site occupied by an industrial estate.</p>
<p>Occupier Profile (if partly developed, including % of available land and levels of vacancy onsite)</p>	<p>This site is fully developed and occupied by a mix of uses including a Lidl supermarket, i-Jump Trampoline Park, Greggs bakery, Angels Gym, a pet supplies store, a caravan dealer and a charity.</p> <p>There is a substantial number of homewares and DIY shops on the site including United Carpets and Beds, Bubbles Bathrooms, Screwfix, Appliance People, Kitchen World, Howdens Joinery, Jewson Building Supplies and Millwood Timber.</p>

	<p>There are a number of B2/B8 units occupied by a range of uses including tool manufacturers, metal fabricators, welders and commercial printers.</p> <p>Other occupiers include a Royal Mail delivery office and a waste management company, as well as a number of vehicle MOT and repair centres.</p> <p>At the time of the site visit (December 2020) all units appeared to be occupied with only Unit 6 Block 5 adjacent to Greggs comprising of a retail pod of 125.42 sqm currently under offer.</p> <p>Areas of the estate are in poor condition.</p>	
Strategic Road Access	The A60 adjoins the site's western boundary and the A6117 adjoins the site's northern boundary. Junction 28 of the M1 is approx. 13.5km from the site and is accessed via the A60 and A38.	Average
Local Road Access	The site can be accessed via the A6117 (Old Mill Lane) which is a good free-moving, largely residential road which heads South-West and adjoins the B6030 after 1.6km and the A6191 after 4km. From the site, the A60 is accessed via the A6117 to the North. The A60 heads North (Leeming Lane) towards Mansfield Woodhouse and South (Woodhouse Road) towards the centre of Mansfield. The units adjacent to the A60 have direct access from it.	Good
Proximity to Urban Areas and Access to Labour and Services (including public transport / cycling / walking accessibility)	<p>The site is approximately 2.2km North East of Mansfield town centre and approximately 1.6km South of Mansfield Woodhouse (part of the Mansfield Urban Area). The area provides a wide range of facilities and services including schools, medical services and shops. Mansfield also provides a range of recreational facilities and a police station.</p> <p>The A60 adjacent to the site is serviced by bus stops with regular services traveling North towards Shirebrook and Meden Vale and South towards Mansfield and Mansfield train station. Mansfield Woodhouse train station is not accessible from the site by public transport but is under a 2 km walk.</p>	Good / Very Good
Compatibility of Adjoining Uses (including amenity impacts experienced by current/future occupiers and neighbouring areas)	The site is bound by the A6117 to the north with residential areas beyond, by the River Maun, woodland and water treatment works to the east, to the south by residential areas and The Brunts Academy school and school fields and to the west by the A60 with residential areas beyond.	Average / Poor
Developmental and Environmental Constraints	This is a large industrial estate with utilities and communications infrastructure in place.	Good

<p>(e.g. size; topography; site access; roads, lighting, landscaping, mains utilities and communications infrastructure; flood risk; contamination; nature and heritage conservation)</p>	<p>The site slopes gently down from the A60 to the west.</p> <p>There is an electricity pylon in the west of the site and overhead lines intersect the site east to west.</p> <p>The site is within Flood Zone 1 and therefore at low risk of flooding.</p> <p>The Maun Valley Park Local Nature Reserve is approximately 175m east of the site.</p> <p>There is a grade II listed building Woodhouse Place (ref. 1251911) within 150m west of the site.</p>	
<p>Barriers to Delivery and Mitigation (including ownership constraints - if known)</p>	<p>The site is fully developed and no other barriers to redevelopment were evident from the site visit.</p>	<p>Very Good</p>
<p>Market Attractiveness (including appropriateness, vacancy and market activity on site for the type of development proposed)</p>	<p>This is a large site within the main urban area of Mansfield with good local road access and access to labour markets and services. Vacancy levels were low at the time of the site visit. Areas of the estate are in poor condition and would benefit from upgrade or renewal to improve the site's kerb appeal.</p>	<p>Average</p>
<p>Strategic Fit with Growth Area Objectives (by target Market Segment)</p>	<p>This site already accommodates key industrial growth sectors as identified in the D2N2 Vision 2030 document including construction and retail. It is located within Mansfield urban area and has potential to accommodate other key industrial growth sectors.</p>	<p>Average</p>
<p>OVERALL SITE RATING</p>	<p>Average</p>	
<p>Recommendation and Potential Future Uses</p>	<p>Protect for employment uses (i.e. retain employment land allocation as a as a key / general employment area).</p>	
<p>SITE SUMMARY:</p>		
<p>This is a successful industrial estate on the northern periphery of Mansfield. The employment uses have been diluted by a range of other uses including a supermarket, bakery, leisure uses and a range of homewares/DIY shops. Areas of the estate are in poor condition and would benefit from upgrade or renewal. However, the site is fully developed and vacancy levels are low. The site provides important local employment space and is designated as a key / general employment area and it is recommended that the site is protected for employment uses.</p>		

Sherwood Oaks Business Park (Ref: MDC2)



**GROSS SITE AREA:
11.45 ha**

**ESTIMATED NET DEVELOPABLE AREA:
3.09 ha**
(Note: Comprising of land to the south of the hospital (Local Plan ref: 1.41 ha) and land south of Oak leaf close (Local Plan ref, area 1.68 ha) excluding the MKM building supplies development)

CRITERIA	COMMENT	RATING
<p>Site Context</p> <ul style="list-style-type: none"> • Location with regards to existing employment areas and other sites • How the site fits into the overall portfolio 	<p>This site comprises of modern detached office buildings, car showrooms, a hospital, a supermarket, a pub/restaurant and a building supplies store. There are a couple of smaller undeveloped areas within the site comprising of land to the south of Oak Leaf Close and land to the south of St Andrew's Healthcare.</p> <p>It is within a wider industrial area along Southwell Road West (A6191) on the south-eastern outskirts of Mansfield. It is adjacent to the Bellamy Road Industrial Estate and the Ratcher Hill employment area, and in close proximity to Oak Tree Business Park and Ransom Wood Business Park.</p>	
<p>Local Plan Designation</p>	<p>The Development Plan for Mansfield comprises of the Mansfield District Local Plan 2013-2033 (Adopted September 2020). The site is designated as a Key / General Employment Area (Policy E3b).</p> <p>Two sites immediately west of Sherwood Avenue are allocated as a housing commitment (Policy H2) and a housing allocation (Policy H1e).</p> <p>Land immediately south of the site and south of Old Newark Road is allocated as a committed strategic urban extension (Policy SUE3).</p>	
<p>Status in SHLAA</p>	<p>The HELAA (2017) identified a few smaller sites within the</p>	

	wider site as 'reasonable alternative' sites (refs. 27c, 41 and 169). However, they are not currently being promoted through the HELAA.
Planning History	<p>Recent planning history includes:</p> <ul style="list-style-type: none"> • 2019/0444/FUL – Full planning application – 21 No. Industrial Units for B1C, B2 and B8 Use in 4 No. Blocks Including Associated External Works with Access to Existing Road – Pending Decision • 2018/0135/FUL – Full planning application – Erect building for use as a builder's merchant – Grant 01.05.2018 • 2013/0376/ST – Full planning application – Erect Two Storey, Self-contained office building – Grant 19.09.2013 <p>An outline application for 169 residential dwellings has been submitted, which borders the employment area to the south and is pending a decision:</p> <ul style="list-style-type: none"> • 2018/0379/OUT – Outline planning application – Outline application for up to 169 no. residential dwellings and means of access, with all other matters reserved. (Resubmission of Planning Application 2018/0379/OUT)
Current Use and Land Type	This is brownfield site occupied by a business park with a mix of uses including employment.
Occupier Profile (if partly developed, including % of available land and levels of vacancy onsite)	<p>The development is modern with an open layout and high-quality purpose-built buildings providing an attractive working environment.</p> <p>The employment uses on the site are somewhat diluted; the site contains car salesrooms, modern offices, a hospital, a restaurant, a supermarket and a building supplies shop. Occupiers include Ford and Skoda car salesrooms, St Andrew's Healthcare (mental health hospital), Bridge Bank (civil engineers), Miller Knight (fire protection service), The Golden Eagle Marston's restaurant, Aldi and MKM Building Supplies.</p> <p>At the time of the site visit (November 2020) there was one office on the market comprising of 288 sqm. However, this is now under offer.</p> <p>There are a few potential development plots on the site as follows:</p> <p>The land to the south of St Andrew's Healthcare comprising of 1.41 ha was vacant at the time of the site visit. It is identified in the HELAA (ref. 27c) as not currently being promoted by the landowner and therefore it is a reasonable alternative site. The site is limited to use class E office development due to adjoining residential uses. An application for employment uses is pending (ref. 2019/0444/FUL).</p>

	<p>The land to the south of the office units off Oak Leaf Close and east of the new Aldi store comprises of 2.67 ha. It includes the new MKM building supplies store (site area 0.7ha). However, the land to the south of Oak Leaf Close was vacant at the time of the site visit. The HELAA identified the site (ref. 41) as a reasonable alternative site and it was not being promoted by the landowner.</p> <p>The land adjacent Unit 3 is within the wider HELAA site ref. 41 discussed above. It is identified in the HELAA as comprising 0.12 ha (ref. 169), it has permission (ref. 2013/0376/ST) and is identified as a reasonable alternative site.</p>	
Strategic Road Access	<p>The site is adjacent to and accessed from Southwell Road West (A6191). The A6191 joins the A617 approximately 500m east of the site. The A6191 continues 3.4 km North West to the A60 and Junction 28 of the M1 is 14.3km away via the A617 and A38.</p>	Average
Local Road Access	<p>The site can be accessed from the A6191 which is a good free-moving road heading North West towards Mansfield and South East towards the B6020 (Mansfield Road) and the A617. The B6020 continues South East towards Rainworth. The A617 continues East towards Newark-on-Trent and West towards Sutton-in-Ashfield.</p> <p>The site's internal spine road Sherwood Avenue branches off from Southwell Road West.</p>	Very Good
Proximity to Urban Areas and Access to Labour and Services (including public transport / cycling / walking accessibility)	<p>The site is located on the south-eastern outskirts of Mansfield. Mansfield town centre provides a wide range of facilities and services including schools, medical services, shops, recreational facilities and a police station.</p> <p>The residential suburb of Berry Hill is located to the west of the site. The site is also to the south of Oak Tree Lane and surrounding residential area, as well as Tesco Extra. The site is located 2km North West of Rainworth village via the A6191 and B6020 which provides schools, a health centre, local shops, post office and takeaway.</p> <p>The site is serviced by regular bus services via stops on the A6191 travelling South East (towards Nottingham and Rainworth, and less frequent services to Newark, Blidworth, Bilsthorpe and Eakring) and North West (towards Mansfield and Sutton in Ashfield). Mansfield railway station is 4.5km away and is serviced by regular bus stops on the A6191.</p>	Average

Compatibility of Adjoining Uses (including amenity impacts experienced by current/future occupiers and neighbouring areas)	The site is bound by the A6191 to the north, Old Newark Road to the east and south (an unsurfaced track road, one-car wide) with fields beyond to the A617, and The Anglia Way/Bellamy Road industrial estates to the west.	Very Good
Developmental and Environmental Constraints (e.g. size; topography; site access; roads, lighting, landscaping, mains utilities and communications infrastructure; flood risk; contamination; nature and heritage conservation)	This is a large site with access from Southwell Road West, utilities and communications infrastructure are already in place. The site slopes gently from north to south and is within Flood Zone 1 and therefore at low risk of flooding. There are no heritage or environmental designations within or adjacent to the site.	Very Good
Barriers to Delivery and Mitigation (including ownership constraints - if known)	There are a couple of undeveloped sites comprising of land to the south of Oak Leaf Close and land to the south of St Andrew’s Healthcare. A small plot south of east of the office blocks is owned by Intelligent Money Limited. No other constraints to redevelopment were apparent from the site visit.	Very Good
Market Attractiveness (including appropriateness, vacancy and market activity on site for the type of development proposed)	This is a large site within the main urban area of Mansfield. It is highly visible from Southwell Road West and is occupied by a range of uses and has low vacancy levels. The development is modern with an open layout and high-quality purpose-built buildings providing an attractive working environment. Despite this, build-out of the site has been slow.	Good
Strategic Fit with Growth Area Objectives (by target Market Segment)	This site already accommodates key industrial growth sectors as identified in the D2N2 Vision 2030 document including professional/business services, healthcare and retail.	Good
OVERALL SITE RATING	Good	
Recommendation and Potential Future Uses	Allocate for employment uses – allocate undeveloped land for employment uses and protect remainder for employment uses (i.e. retain allocation as a key / general employment area).	
SITE SUMMARY:		
This site comprises of modern detached office buildings, car salesrooms, a hospital, a supermarket, a restaurant and a building supplies store. There are a couple of undeveloped sites comprising of land to the south of Oak Leaf Close and land to the south of St Andrew’s Healthcare. It is within a wider industrial area along Southwell Road West (A6191) on the south-eastern outskirts of Mansfield. It is adjacent to the Bellamy Road Industrial Estate and the Ratcher Hill employment area, and in close proximity to Oak Tree Business Park and Ransom Wood Business Park. It is designated in the Local Plan as a key / general employment area although it has become increasingly watered down by sui generis and other non-E/B class uses. It is recommended that the undeveloped land is allocated for employment uses and the remainder protected for employment uses.		

Millennium Business Park (Ref: MDC3)



**GROSS SITE AREA:
20.16 ha**

**ESTIMATED NET DEVELOPABLE
AREA:
0.51 ha**

CRITERIA	COMMENT	RATING
<p>Site Context</p> <ul style="list-style-type: none"> • Location with regards to existing employment areas and other sites • How the site fits into the overall portfolio 	<p>This is a modern and successful business park on the northern fringe of Mansfield.</p> <p>The site is approximately 2.5km north of the Penniment Farm site and 3km west of the Old Mill Lane Industrial Estate.</p>	
<p>Local Plan Designation</p>	<p>The Development Plan for Mansfield comprises of the Mansfield District Local Plan 2013-2033 (Adopted September 2020). The site is designated as a Key / General Employment Area (Policy E3c).</p>	
<p>Status in SHLAA</p>	<p>The HELAA (2017) identified a number of smaller areas within the site as follows:</p> <ul style="list-style-type: none"> • Site ref 148 – Millenium Business Park Site A off Concorde Way adjacent to the Bull Farm Primary Care Centre – 0.32 ha – reasonable alternative site. This site is still undeveloped. • Site ref 201 – Land behind Takbro Ltd off Concorde Way – 0.19 ha – unimplemented permission (2017/0100/FUL) – reasonable alternative site. This site is still undeveloped. • Site ref 202 – Plot 10a Enterprise Road – 1.59 ha – planning permission granted (2016/0715/FUL) – reasonable alternative site. This permission has been implemented and the site is occupied by JKS Boyles. 	
<p>Planning History</p>	<p>Recent planning applications include:</p> <ul style="list-style-type: none"> • 2016/0715/FUL – Full planning application – New Industrial Building Incorporating a combination of 	

	<p>workshops (B2 Use) with Associated Offices (B1 Use), Car Parking and External Yard Area</p> <ul style="list-style-type: none"> • 2017/0100/FUL – Full planning application – Erection of a single industrial unit for B1/B2/B8 use – Granted 04.05.2017 • 2017/0323/COU – Change of use application – Change of Use to Gymnasium • 2019/0113/FUL – Full planning application – Extension to Food Production Area and Reposition External Cold Store Plant Equipment to First Floor Internal Plant Room – Granted 24.04.2019 • 2019/0550/FUL – Full planning application – Demolish Wooden Single Storey Side Extension (121 sq.mtr.) and Erect a Single Storey Side Extension (542 sq. mtr.) to Existing Factory – Granted 24.09.2019
<p>Current Use and Land Type</p>	<p>This is a brownfield site occupied by a business park.</p>
<p>Occupier Profile (if partly developed, including % of available land and levels of vacancy onsite)</p>	<p>The development is modern with a spacious attractive layout and high-quality purpose-built buildings providing an attractive working environment.</p> <p>The site is occupied by Use Class E, B2, B8 and sui generis uses. The Mansfield Networkcentre is located on the site and comprises of 12 high quality workspace units. The Bull Farm Primary Care Centre is located in the southern corner of the site and there is a Volkswagen car salesroom in the western corner of the site.</p> <p>Other occupiers include: JKS Boyles (drilling equipment supplier) Howarth Timber Euro Car Parts Trent Ceramics (tile store) Realm Projects (shop fitter) Integrated Doorsets Future Products (double glazing supplier) Solus Scientific (manufacturer of food safety testing equipment)</p> <p>At the time of the site visit (November 2020) the following vacant units were apparent:</p> <ul style="list-style-type: none"> • Unit 1A Isabella Court – 646 sqm warehouse • Unit 3 Concorde Way – 1,061 sqm warehouse <p>There are also a couple remaining development plots on the site:</p> <ul style="list-style-type: none"> • HELAA ref 148 – Millenium Business Park Site A off Concorde Way adjacent to the Bull Farm Primary Care Centre – 0.32 ha – reasonable alternative site. This site is still undeveloped. • HELAA ref 201 – Land behind Takbro Ltd off Concorde Way – 0.19 ha – unimplemented permission (2017/0100/FUL) – reasonable alternative site. This site

	is still undeveloped.	
Strategic Road Access	The site adjoins the A6191 via its access roads (Enterprise Road and Concorde Way). The A6191 converges with the A617 approximately 800m north of the site. The site is 8.3 km from junction 29 of the M1 via the A617.	Average
Local Road Access	The site can be accessed from the A6191 which is a good free-moving road heading North West (Chesterfield Road North) towards the A617 and Pleasley and South East (Chesterfield Road South) towards Mansfield.	Very Good
Proximity to Urban Areas and Access to Labour and Services (including public transport / cycling / walking accessibility)	The site is located on the North West outskirts of Mansfield, with the village of Pleasley approximately 2.4km to the North West of the site and Mansfield Woodhouse approximately 3.2km to the East of the site. Pleasley is a small village with few amenities/services. Mansfield and Mansfield Woodhouse both provide a wide range of facilities and services including schools, medical services and shops. Mansfield also provides a range of recreational facilities and a police station. The Site is serviced by regular bus services via stops on the A6191 travelling South East towards Mansfield and Nottingham and North West towards Chesterfield and Whaley Thorns. Mansfield railway station is just over 4km away and is serviced by regular buses from the A6191. From the site, Mansfield Woodhouse railway station is not accessible by public transport.	Average
Compatibility of Adjoining Uses (including amenity impacts experienced by current/future occupiers and neighbouring areas)	The site is bound by a footpath to the North, North East and North West of the site and beyond that, a solar farm to the North East and greenfield land to the North and North West. The A6191 borders the South West of the site, with residential areas beyond and to the North West and South East.	Average
Developmental and Environmental Constraints (e.g. size; topography; site access; roads, lighting, landscaping, mains utilities and communications infrastructure; flood risk; contamination; nature and heritage conservation)	This is a well-established business park with utilities and communications infrastructure in place. The site is within Flood Zone 1 and therefore at low risk of flooding. There are no historic or environmental designations within or in close proximity to the site.	Very Good
Barriers to Delivery and Mitigation (including ownership constraints - if known)	No obvious barriers to redevelopment were evident from the site visit.	Very Good
Market Attractiveness (including appropriateness, vacancy and market	This is a well-established industrial estate on the northern fringe of Mansfield. The development is	Good

activity on site for the type of development proposed)	modern with a spacious attractive layout and high-quality purpose-built buildings providing an attractive working environment. Vacancy levels were low and there are a couple of small sites potentially suitable for redevelopment.	
Strategic Fit with Growth Area Objectives (by target Market Segment)	This site already accommodates key industrial growth sectors as identified in the D2N2 Vision 2030 document including professional/business services, healthcare, construction and retail.	Average
OVERALL SITE RATING	Good	
Recommendation and Potential Future Uses	Allocate for employment uses (i.e. retain allocation as a key / general employment area)	
SITE SUMMARY:		
<p>This is a modern and successful business park on the northern fringe of Mansfield. The employment uses are diluted by The Bull Farm Primary Care Centre and a Volkswagen car salesroom within the site. Vacancy levels were low and there are a couple of small sites potentially suitable for redevelopment.</p> <p>The site is designated as a key / general employment area in the Local Plan and it is recommended that the site is allocated for employment uses.</p>		

Oakham Business Park (Ref: MDC4)



GROSS SITE AREA: 25.69 ha	ESTIMATED NET DEVELOPABLE AREA: 0 ha
--	---

CRITERIA	COMMENT	RATING
Site Context <ul style="list-style-type: none"> • Location with regards to existing employment areas and other sites • How the site fits into the overall portfolio 	<p>This is a well-established business park within a wider industrial area on the south-western outskirts of Mansfield. It is adjacent to the Hermitage Lane Industrial Estate and the new Amazon distribution centre at Summit Park is approximately 200m to the south.</p>	
Local Plan Designation	<p>The Development Plan for Mansfield comprises of the Mansfield District Local Plan 2013-2033 (Adopted September 2020). The site is designated as a Key / General Employment Area (Policy E3d).</p>	
Status in SHLAA	<p>The HELAA (2017) identified a couple of small sites within the wider site as 'reasonable alternative' sites (ref. 141 and 142).</p>	
Planning History	<p>Recent planning history relates to the employment uses onsite.</p>	
Current Use and Land Type	<p>This is a brownfield site occupied by an established business park.</p>	
Occupier Profile (if partly developed, including % of available land and levels of vacancy onsite)	<p>The site is occupied by a range of B2/B8 warehouses as well as offices and starter units, most are modern units of good quality.</p> <p>Occupiers include: East Midlands Ambulance Support Mansfield Innovation Centre (business centre) Belton Massey Catalysts Total Integrated Solutions (security system installer)</p>	

	<p>Capita (intelligent communications) Marstons Logistics (food and drink) Paccor Packaging (manufacturing) Kent Group (electrical engineering) HAB Motorhomes (dealer) Mayborn Group Sangenic (baby products manufacturer) CEF Trade (electrical wholesaler) Glenair (electronics manufacturer) Reflex Labels (manufacturer) There were low vacancy levels at the time of the site visit (November 2020). There were only a number of offices to let in the Mansfield Innovation Centre and Enterprise Court.</p>	
Strategic Road Access	<p>The site is 1km from the A60 heading North East, 0.6km from the A38 heading North West and 0.5km from the A617 to the South West. The site is 9.3km from junction 28 of the M1 via the A617 and A38.</p>	Poor / Average
Local Road Access	<p>The site is accessed via Hamilton Way which runs from the North East through to the South West of the site. From the North East, Hamilton Way adjoins Sheepbridge Lane which is a good free-moving residential road eventually meeting the A60 heading South East (passing a Primary School). From the South West, Hamilton Way is accessed via Hamilton Road which meets the A617 after 0.5km.</p>	Good
Proximity to Urban Areas and Access to Labour and Services (including public transport / cycling / walking accessibility)	<p>The site is located on the South West outskirts of Mansfield, located 3.2km to the North East of the site via the A38. The town of Sutton-in-Ashfield is approximately 4km to the west of the site via the A617 and B6023.</p> <p>Mansfield and Sutton-in-Ashfield both provide a wide range of facilities and services including schools, medical services and shops. Mansfield also provides a range of recreational facilities and a police station.</p> <p>There are bus stops along Hamilton Way with services to Mansfield.</p> <p>Mansfield railway station is just over 2km away and is serviced by regular buses from the A38.</p>	Good
Compatibility of Adjoining Uses (including amenity impacts experienced by current/future occupiers and neighbouring areas)	<p>The site is bound to the North by the River Maun and Sheepbridge Lane with allotments and residential areas beyond, to the east by Oakham Nature Reserve and a small fishing lake, to the south by the new Amazon distribution centre at Summit Park and to the west by the wider Hermitage Lane industrial area.</p>	Good
Developmental and	<p>This is a large established business park with</p>	Poor

<p>Environmental Constraints (e.g. size; topography; site access; roads, lighting, landscaping, mains utilities and communications infrastructure; flood risk; contamination; nature and heritage conservation)</p>	<p>access from Hamilton Way and internal spine roads, utilities and communications infrastructure are already in place.</p> <p>The site slopes gently from north to south. The majority of the site is within Flood Zone 1 and therefore at low risk of flooding. However, there is a small area south of Sheepbridge Lane within Flood Zone 2 and 3.</p> <p>The Oakham Local Nature Reserve intersects the site and bounds the site to the east. Matlock Mill Joinery works within the northern portion of the site is grade II listed (ref. 1279862).</p> <p>Quarry Lane Local Nature Reserve is located immediately north of the site. Drury Dam Viaduct (grade II listed ref. 1207187), Hermitage Mill (grade II listed ref. 1288578) and the railway bridge 100 metres west of Hermitage Mill (grade II listed ref. 1207169) are within 400m of the site. The Hermitage Local Nature Reserve and King's Mill Viaduct scheduled monument are within 500m of the site.</p>	
<p>Barriers to Delivery and Mitigation (including ownership constraints - if known)</p>	<p>The majority of the site is in MDC ownership. The site is fully developed. Any redevelopment of the site would need to consider the environmental and heritage constraints listed above.</p>	Average
<p>Market Attractiveness (including appropriateness, vacancy and market activity on site for the type of development proposed)</p>	<p>This is a large site within the main urban area of Mansfield. It is occupied by a range of employment uses and has low vacancy levels. This is a high-quality modern employment area based on the Hamilton Lane corridor. The overall environmental quality is high.</p>	Very Good
<p>Strategic Fit with Growth Area Objectives (by target Market Segment)</p>	<p>This site already accommodates key industrial growth sectors as identified in the D2N2 Vision 2030 document including professional/business services, creative & digital, food & drink manufacturing, health & social care, logistics & e-commerce and retail.</p>	Good
<p>OVERALL SITE RATING</p>	<p>Good</p>	
<p>Recommendation and Potential Future Uses</p>	<p>Protect for employment uses (i.e. retain allocation as a key / general employment area)</p>	
<p>SITE SUMMARY:</p>		
<p>This is a well-established and popular industrial estate within a wider industrial area on the south-western outskirts of Mansfield. It is adjacent to the Hermitage Lane Industrial Estate and the new Amazon distribution centre at Summit Park is approximately 200m to the south. The site has a number of environmental and heritage constraints including areas at risk of flooding as well as Local Nature Reserves and heritage assets within or in close proximity to the site. The site</p>		

accommodates a range of B2/B8 warehouses as well as offices and starter units and the Mansfield Innovation Centre in a high-quality environment. The site is designated as a key / general employment area in the Local Plan and it is recommended that the site is protected for employment uses.

Oak Tree Business Park (Ref: MDC5)

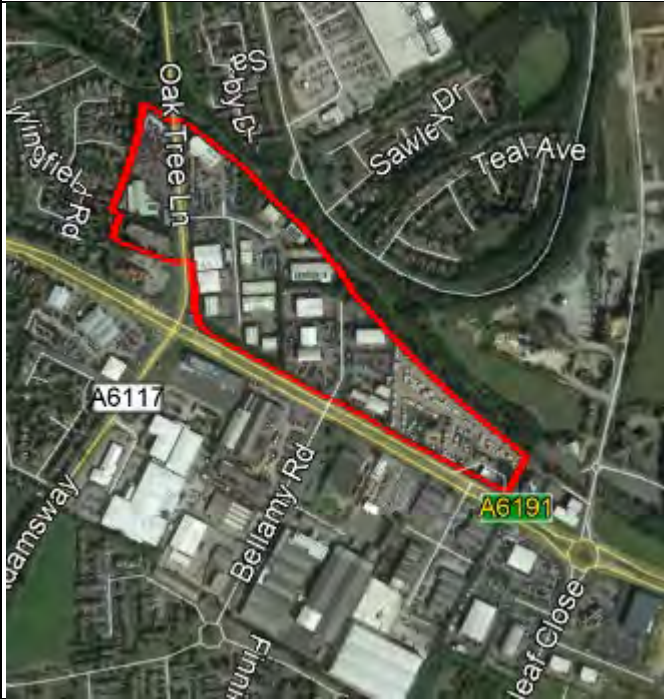

GROSS SITE AREA:
10.05 ha

ESTIMATED NET DEVELOPABLE AREA:
0 ha

CRITERIA	COMMENT	RATING
<p>Site Context</p> <ul style="list-style-type: none"> • Location with regards to existing employment areas and other sites • How the site fits into the overall portfolio 	<p>This site comprises of car salesrooms, MOT and service centres, some workspaces, caravan storage and homewares supply stores.</p> <p>The site is within a wider industrial area along Southwell Road West (A6191) on the south-eastern outskirts of Mansfield. It is adjacent to Ratcher Hill Employment Area and Quarry, and across the road from Bellamy Road Industrial Estate.</p>	
<p>Local Plan Designation</p>	<p>The Development Plan for Mansfield comprises of the Mansfield District Local Plan 2013-2033 (Adopted September 2020). The site is designated as a Key / General Employment Area (Policy E3e).</p>	
<p>Status in SHLAA</p>	<p>N/A</p>	
<p>Planning History</p>	<p>No recent planning history.</p>	
<p>Current Use and Land Type</p>	<p>This is a brownfield site currently occupied by a range of employment and sui generis uses.</p>	
<p>Occupier Profile (if partly developed, including % of available land and levels of vacancy onsite)</p>	<p>The site is primarily occupied by car salesrooms (Renault, Honda, Hyundai, Toyota and Peugeot), MOT and service centres, an Esso petrol filling station and a caravan storage site. There are a range of B2/B8 units off Oakwood Road/Acorn Way. Other occupiers include: Mansfield Sand, The Paint Shack.com, Water Direct, Sherwood Aluminium Systems and City Plumbing Supplies</p> <p>At the time of the site visit (November 2020) all units appeared to be occupied.</p>	

	The site would benefit from investment in public realm, boundaries and landscaping.	
Strategic Road Access	The site adjoins the A6191 via its access roads (Sovereign Way and Oakwood Road via Oak Tree Lane) and is 14.5km from junction 28 of the M1 via the A617 and A38.	Average
Local Road Access	The site can be accessed from the A6191 which is a good free-moving road heading North West towards Mansfield and South East towards the B6020 (Mansfield Road) and the A617. The B6020 continues South East towards Rainworth. The A617 continues East towards Newark-on-Trent and West towards Sutton-in-Ashfield.	Very Good
Proximity to Urban Areas and Access to Labour and Services (including public transport / cycling / walking accessibility)	<p>The site is located on the south-eastern periphery of Mansfield. Mansfield town centre provides a wide range of facilities and services including schools, medical services, shops, recreational facilities and a police station. Mansfield railway station is 5km away and is serviced by regular buses from the A6191 and A6117.</p> <p>The site is 2.9km North West of Rainworth village via the A6191 and B6020 which provides schools, a health centre, local shops, post office and takeaway.</p> <p>The Site is serviced by regular bus services via stops on the A6191 travelling South East (towards Nottingham and Rainworth, and less frequent services to Newark, Blidworth, Bilsthorpe and Eakring) and North West (towards Mansfield and Sutton in Ashfield). The North West of the site is also serviced by bus stops on the A6117 (Oak Tree Lane) for hourly services towards Mansfield and Forrest Town.</p>	Average / Good
Compatibility of Adjoining Uses (including amenity impacts experienced by current/future occupiers and neighbouring areas)	The site is bordered by mature trees with residential/commercial areas to the north, to the east by the Ratcher Hill employment area and quarry including the Mansfield Asphalt plant, to the south by the A6191 and to the west by residential areas.	Average
Developmental and Environmental Constraints (e.g. size; topography; site access; roads, lighting, landscaping, mains utilities and communications infrastructure; flood risk; contamination; nature and heritage conservation)	<p>This is a medium-sized site occupied by a range of employment and sui generis uses with utilities and communications infrastructure in place. It slopes gently down to the north.</p> <p>The site is within Flood Zone 1 and therefore at low risk of flooding. There are no heritage designations within or in close proximity to the</p>	Very Good

	<p>site.</p> <p>Oak Tree Heath Local Nature Reserve is within 250m of the site to the north.</p>	
<p>Barriers to Delivery and Mitigation (including ownership constraints - if known)</p>	<p>The site is fully developed. No other barriers to redevelopment were obvious at the site visit.</p>	<p>Very Good</p>
<p>Market Attractiveness (including appropriateness, vacancy and market activity on site for the type of development proposed)</p>	<p>This site has significant visibility and frontage onto the A6191 and is within the wider Southwell Road West industrial area. Vacancy levels were low.</p>	<p>Good</p>
<p>Strategic Fit with Growth Area Objectives (by target Market Segment)</p>	<p>This site already accommodates key industrial growth sectors as identified in the D2N2 Vision 2030 document including professional/business services, construction and retail.</p>	<p>Average</p>
<p>OVERALL SITE RATING</p>	<p>Average</p>	
<p>Recommendation and Potential Future Uses</p>	<p>Protect for employment uses (i.e. retain allocation as a key / general employment area)</p>	
<p>SITE SUMMARY:</p> <p>This site comprises of a mix of sui generis and employment uses - primarily car salesrooms, MOT and service centres, caravan storage and homewares supply stores. The site is within a wider industrial area along Southwell Road West (A6191) on the south-eastern outskirts of Mansfield. It is adjacent to Ratcher Hill Employment Area and Quarry, and across the road from Bellamy Road Industrial Estate. The site is fully developed and vacancy levels were low at the time of the site visit. The site is designated as a key / general employment area in the Local Plan and although it is dominated by Sui Generis uses with few E/B Class uses, it is recommended that the site is protected for employment uses.</p>		

Broadway Industrial Estate (Ref: MDC6)



GROSS SITE AREA:
4.24 ha

ESTIMATED NET DEVELOPABLE AREA:
0 ha

CRITERIA	COMMENT	RATING
<p>Site Context</p> <ul style="list-style-type: none"> • Location with regards to existing employment areas and other sites • How the site fits into the overall portfolio 	<p>This is a small existing employment site near the centre of Mansfield. The site is approximately 2km north east of the Hamilton Way industrial area and approximately 2.5km east of the Southwell Road West industrial area.</p>	
<p>Local Plan Designation</p>	<p>The Development Plan for Mansfield comprises of the Mansfield District Local Plan 2013-2033 (Adopted September 2020). The site is designated as a Key / General Employment Area (Policy E3g).</p>	
<p>Status in SHLAA</p>	<p>N/A</p>	
<p>Planning History</p>	<p>No recent planning history.</p>	
<p>Current Use and Land Type</p>	<p>This is a brownfield site occupied by an industrial estate.</p>	
<p>Occupier Profile (if partly developed, including % of available land and levels of vacancy onsite)</p>	<p>The site is occupied by a mixture of office space and B2/B8 industrial units. Non-employment uses include: Ace Carwash, Personal Best Academy (martial arts school), 776 Gymnastics and My Dentist.</p> <p>Severn Trent Water offices are located off Great Central Road, other employment uses include:</p> <p>RB Wholesale Catering Supplier Jewson builder's merchants Brandon Tool Hire Alma Engineering R&K Garage vehicle repairs</p>	

	<p>Clays Motors MOT Centre M J Stenson builder J&P Samples clothing manufacturer Arrowdale builder Heat Care plumber Electrotec BMS (energy equipment manufacturer) Mansfield Steel (manufacturer of outdoor shelters and street furniture)</p> <p>At the time of the site visit there was one unit on the market – a modern detached office/workshop comprising of 398 sqm.</p>	
Strategic Road Access	<p>The site is within 200m of the A60 via the A6191. The A60 heads north to Worksop and south to Nottingham. The A38 is approximately 1.3km from the site via the A60 and the A6191 is approximately 1km from the site via the A60.</p>	Poor
Local Road Access	<p>The site is accessed from Great Central Road to the east and the site's internal access road The Broadway. Great Central Road converges with the A6191 to the north which is a good free-moving road. The A6191 joins the A60 approximately 200m west of the site.</p>	Good
Proximity to Urban Areas and Access to Labour and Services (including public transport / cycling / walking accessibility)	<p>The site is situated within the Mansfield urban area approximately 1km from Mansfield railway station. Mansfield provides a wide range of facilities and services including schools, medical services, shops and recreational facilities.</p> <p>The A6191 adjoining the site provides a regular bus service to Mansfield and less frequent services to Sutton in Ashfield, Newark, Eakring, Rainworth, Oak Tree and Nottingham.</p>	Very Good
Compatibility of Adjoining Uses (including amenity impacts experienced by current/future occupiers and neighbouring areas)	<p>The site is bound by the A6191 to the north with residential and commercial uses beyond, by residential properties to the east and south and by Great Central Road to the west with Mansfield Police Station beyond.</p>	Poor
Developmental and Environmental Constraints (e.g. size; topography; site access; roads, lighting, landscaping, mains utilities and communications infrastructure; flood risk; contamination; nature and heritage conservation)	<p>This is a small employment site with utilities and communications infrastructure in place. There is a telecommunications mast located in the north-western corner of the site.</p> <p>33 Ratcliffe Gate opposite the site is Grade II listed (ref. 1215108). There is a cluster of listed buildings along Nottingham Road and also around Bridge Street, both within 400m to the west of the site.</p> <p>There are no environmental designations on or</p>	Average

	within close proximity to the site. The site is within Flood Zone 1 and therefore at low risk of flooding.	
Barriers to Delivery and Mitigation (including ownership constraints - if known)	Any future redevelopment of the site would need to take the amenity impact upon adjoining residential uses into consideration. The site is fully developed and no other constraints to redevelopment were evident from the site visit.	Average
Market Attractiveness (including appropriateness, vacancy and market activity on site for the type of development proposed)	This is a small existing employment site located close to the town centre with good local road access and access to labour markets and services. Vacancy levels were low at the time of the site visit. It would benefit from investment in public realm and landscaping.	Average
Strategic Fit with Growth Area Objectives (by target Market Segment)	This site does not currently accommodate key industrial growth sectors as identified in the D2N2 Vision 2030 document. However, it is located within Mansfield urban area and has potential to accommodate key industrial growth sectors.	Poor
OVERALL SITE RATING	Average	
Recommendation and Potential Future Uses	Protect for employment uses (i.e. retain allocation as a key / general employment area)	
SITE SUMMARY:		
This is a small existing employment site near the centre of Mansfield. The site is approximately 2km north east of the Hamilton Way industrial area and approximately 2.5km east of the Southwell Road West industrial area. The site is occupied by a mixture of office space and B2/B8 industrial units as well as some non-employment uses. The site is fully developed and only one unit was available at the time of the site visit. The site is designated as a key / general employment area in the Local Plan and it is recommended that the site is protected for employment uses.		

Crown Farm Industrial Estate (Ref: MDC7)



**GROSS SITE AREA:
56.64 ha**

**ESTIMATED NET DEVELOPABLE AREA:
4.05 ha**

(Comprising of HELAA sites 137, 143 and 216 which were still undeveloped. If the SUE2 (Land off Jubilee Way) allocation comes forward this could increase the net developable area by 1.6 ha.)

CRITERIA	COMMENT	RATING
<p>Site Context</p> <ul style="list-style-type: none"> • Location with regards to existing employment areas and other sites • How the site fits into the overall portfolio 	<p>This is a well-established industrial estate on the eastern fringe of Mansfield. The site provides accommodation to a number of key occupiers within the region including Toray Textiles, Crown Packaging, Plastek Limited and sps Aerostructures.</p> <p>The site is approximately 2km north of the Southwell Road West industrial area.</p>	
<p>Local Plan Designation</p>	<p>The Development Plan for Mansfield comprises of the Mansfield District Local Plan 2013-2033 (Adopted September 2020). The site is designated as a Key / General Employment Area (Policy E3j).</p> <p>There is an allocation for a Strategic Urban Extension SUE2 (Land off Jubilee Way) which is immediately to the south of the site. It comprises of 46.83 ha for c.800 dwellings and 1.6 ha (net developable area) extension to Crown Farm Industrial Estate. There is a housing allocation H1a (Clipstone Road East) immediately north east of the site which is split into two sections for 313 in the western portion and 198 dwellings in the eastern portion.</p>	
<p>Status in SHLAA</p>	<p>The HELAA (2017) identified a number of smaller areas within the site as follows:</p> <ul style="list-style-type: none"> • 71a – Site A, Long Stoop Way – 2.28ha – proposals for 	

	<p>modification/intensification of employment use however, the site is tenanted – reasonable alternative site.</p> <ul style="list-style-type: none"> • 71c – Site C, Long Stoop Way – 0.6 ha - proposals for modification/intensification of employment use however, the site is tenanted – reasonable alternative site. • 137 – Plot 17, Long Stoop Way – 0.25ha – lapsed planning permission – reasonable alternative site. This site is still vacant. • 143 – Crown Farm Industrial Estate Site A – 2.77 ha – not being actively promoted by the landowner – reasonable alternative site. This site is still vacant and comprises of the existing Local Plan allocation. • 216 - Crown Speciality Packaging UK Limited – 1.03ha – permission granted (2017/0843/FUL) – reasonable alternative site. This permission has not yet been implemented.
<p>Planning History</p>	<p>Recent applications on the site include:</p> <ul style="list-style-type: none"> • 2020/0156/FUL – Erection of an industrial stage unit - Plot 6 Mansfield Brick Crown Farm Way – awaiting decision – validated 27.03.2020 • 2017/0843/FUL – Erection of single storey storage building - Crown Speciality Packaging UK Limited, Crown Farm Way – granted – 14.02.2018. This permission has not yet been implemented. <p>There are a number of other historic and minor applications relating to the employment uses on the site.</p>
<p>Current Use and Land Type</p>	<p>This is a brownfield site occupied by B2/B8 employment uses.</p>
<p>Occupier Profile (if partly developed, including % of available land and levels of vacancy onsite)</p>	<p>The site provides modern accommodation to a number of key occupiers within the region including Toray Textiles, Crown Packaging, Plastek Limited and sps Aerostructures.</p> <p>At the time of the site visit (November 2020) there appeared to be only one vacant unit – a warehouse of 9,886 sqm on Crown Farm Way.</p> <p>There are a few remaining development plots on the site:</p> <ul style="list-style-type: none"> • HELAA site 137 – Plot 17, Long Stoop Way – 0.25ha – lapsed planning permission – reasonable alternative site. This site is still vacant. • HELAA site 143 – Crown Farm Industrial Estate Site A – 2.77 ha – not being actively promoted by the landowner – reasonable alternative site. This site is still vacant. • HELAA site 216 - Crown Speciality Packaging UK Limited – 1.03ha – permission granted (2017/0843/FUL) – reasonable alternative site. This permission has not yet been implemented.
<p>Strategic Road Access</p>	<p>The A6117 runs along the West of the site and</p>
	<p>Poor</p>

	<p>provides access to the site entry road, Crown Farm Way, which runs through the centre of the site.</p> <p>The M1 is 16km East from junction 28 of the M1 via the A6117, A617 and A38. The A60 is 2.5km from the site via the A6117 to the North</p>	
Local Road Access	<p>The site can be accessed via the A6117 which is a good, free-moving, largely residential road which heads South and adjoins the A6191 after 2km. The A60 (via the A6117) heads north towards Mansfield Woodhouse and South towards the centre of Mansfield.</p>	Good
Proximity to Urban Areas and Access to Labour and Services (including public transport / cycling / walking accessibility)	<p>The site is located to the south of Forest Town and approximately 3.2km east of Mansfield town Centre. Both settlements provide a wide range of facilities and services including schools, medical services and shops. Mansfield also provides a range of recreational facilities and a police station.</p> <p>The site is served by convenient bus stops on Crown Farm Way, Long Stop Way and Fletchers Way. In addition, busses from the B6030 (0.6km from the site) regularly service Mansfield and Mansfield train station to the West and Forest Town, Clipstone, Walesby and Kirton to the East.</p> <p>National Cycle Route 6 is approximately 1km east of the site with connecting cycle paths from Crown Farm Way.</p>	Average / Good
Compatibility of Adjoining Uses (including amenity impacts experienced by current/future occupiers and neighbouring areas)	<p>The site is bound by mature tree borders to the North and South and residential areas beyond. The A6117 borders the site to the West and greenfield land and Sherwood Forest golf club to the East.</p>	Average
Developmental and Environmental Constraints (e.g. size; topography; site access; roads, lighting, landscaping, mains utilities and communications infrastructure; flood risk; contamination; nature and heritage conservation)	<p>This is a large site occupied by B2/B8 employment uses with utilities and communications infrastructure in place. The site slopes gently down to the north and overhead lines run adjacent to Crown Farm Way.</p> <p>The site is within Flood Zone 1 and therefore at a low risk of flooding. There are areas of higher risk along the site's northern and eastern boundaries.</p> <p>Vicar Water Nature Reserve is approximately 300m east of the site. Sherwood Forest Golf Course SSSI is approximately 700m east of the site.</p>	Good

	The Grade II listed Kingsway Hall (ref. 1251849) is approximately 400m north of the site.	
Barriers to Delivery and Mitigation (including ownership constraints - if known)	No obvious barriers to redevelopment were evident from the site visit.	Very Good
Market Attractiveness (including appropriateness, vacancy and market activity on site for the type of development proposed)	This is a well-established industrial estate on the eastern fringe of Mansfield. The site provides accommodation to a number of key occupiers within the region including Toray Textiles, Crown Packaging, Plastek Limited and sps Aerostructures. Vacancy levels were low and a number of sites potentially suitable for redevelopment were available. The area would benefit from investment in public realm, signage and landscaping in places.	Good
Strategic Fit with Growth Area Objectives (by target Market Segment)	This site already accommodates key industrial growth sectors as identified in the D2N2 Vision 2030 document including professional/business services, construction and retail.	Average
OVERALL SITE RATING	Good	
Recommendation and Potential Future Uses	Allocate for employment uses (i.e. retain allocation as a key / general employment area)	
SITE SUMMARY:		
<p>This is a well-established industrial estate on the eastern fringe of Mansfield. The site provides accommodation to a number of key occupiers within the region including Toray Textiles, Crown Packaging, Plastek Limited and sps Aerostructures. The site is approximately 2km north of the Southwell Road West industrial area. Vacancy levels were low and there were a number of sites potentially suitable for redevelopment. If the SUE2 (Land off Jubilee Way) allocation comes forward in accordance with the Local Plan, including an extension to the Crown Farm Industrial Estate, this could increase the net developable area by 1.6 ha. The site is designated as a key / general employment area in the Local Plan and it is recommended that the site is allocated for employment uses.</p>		

Gateway Off Grove Way (Ref: MDC8)

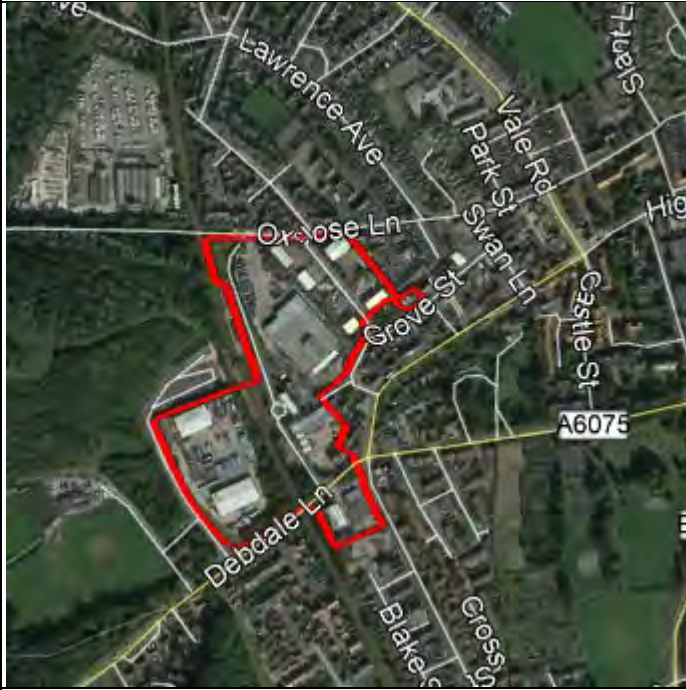

GROSS SITE AREA:
7.35 ha

ESTIMATED NET DEVELOPABLE AREA:
0 ha

CRITERIA	COMMENT	RATING
<p>Site Context</p> <ul style="list-style-type: none"> • Location with regards to existing employment areas and other sites • How the site fits into the overall portfolio 	<p>This is a small existing employment site adjacent to Mansfield Woodhouse Railway Station and intersected by the railway line. The site is 1.2km north-west of the Old Mill Lane Industrial Estate and approximately 1.8km east of the Millennium Business Park.</p>	
<p>Local Plan Designation</p>	<p>The Development Plan for Mansfield comprises of the Mansfield District Local Plan 2013-2033 (Adopted September 2020). The site is designated as a Key / General Employment Area (Policy E3k).</p>	
<p>Status in SHLAA</p>	<p>The HELAA (2017) identified an area within the site – land and buildings off Debdale Lane (0.48 ha); however, the site's availability was unknown, and it appeared to be in active employment use. The site was excluded at Stage 2. At the time of the site visit this was occupied by B&J Parr plastics recycling facility.</p>	
<p>Planning History</p>	<p>No recent planning history.</p>	
<p>Current Use and Land Type</p>	<p>This is a brownfield site in employment use.</p>	
<p>Occupier Profile (if partly developed, including % of available land and levels of vacancy onsite)</p>	<p>Redfern Travel and S&G Coachworks are located immediately to the west of the railway line and east of The Sidings. Immediately east of the railway line there is a small modern office development 'Woodhouse Station Gateway Centre' occupied by This is Kode (web designers) and Mansfield Fire Safety Training Centre. The Woodhouse Station Enterprise Centre is also located here and comprises of starter offices. These are occupied by Moneypennys, Omega Wolf Security,</p>	

	<p>Sports Injury Clinic and two of these units were vacant.</p> <p>To the south of Debdale Lane there is Davenport Accident Repair Centre, Line-X vehicle repairs and Spot-on 2 Snooker and Pool Club.</p> <p>AM Packaging and B&J Parr (plastics recycling facility) are located to the north of Debdale Lane. Off Grove Way there are a number of smaller workshops with occupiers including: D&D Engineering, The Tyre Bay, MB Motors Commercial Sales, Haynes Electrical Services and Blinds by Grace. Off Grove Street there are a few small workshop units occupied by Country Cradles and Picturesque.</p>	
Strategic Road Access	<p>The site is 1.3km from the A60 to the North East and 2.2km from the A6191 to the South West, both accessible via the A6075. Junction 29 of the M1 is approximately 10.8km from the site via the A6075 and A6191/A617.</p>	Poor
Local Road Access	<p>The site is accessed via The Sidings to the west of the site, Sherwood Street to the south east of the site and Station Hill (via Priory Square) leading to Grove Way to the east. All access roads adjoin the A6075 which is a good free-moving road; however, access is constrained by a restricted-height railway bridge (max height 4.0m and only passable by one vehicle at a time) which passes over the road to the south of the site.</p> <p>Grove Way adjoins Oxclose Lane to the north – Oxclose Lane is a narrow unsurfaced road only passable by one vehicle at a time and further constrained by a restricted-height railway bridge (max height 4.5m) to the north of the site.</p>	Poor
Proximity to Urban Areas and Access to Labour and Services (including public transport / cycling / walking accessibility)	<p>The site is situated within the town of Mansfield Woodhouse and approximately 2.3km from Mansfield Town Centre. Both towns provide a wide range of facilities and services including schools, medical services and shops. Mansfield also provides a range of recreational facilities and a police station.</p> <p>Mansfield Woodhouse railway station is situated directly adjacent to the site which provides regular train services to Mansfield and beyond towards Nottingham to the South and Worksop to the North.</p> <p>The A6075 adjoining the site provides a regular bus service to Mansfield. Sherwood Street (0.8km from the site) provides regular bus services towards Mansfield, South Normanton, Alferton and Huthwaite.</p>	Very Good

<p>Compatibility of Adjoining Uses (including amenity impacts experienced by current/future occupiers and neighbouring areas)</p>	<p>The site is bordered by Oxclose Lane to the north with residential areas and caravan storage beyond, by residential areas to the east, by Debdale Lane and residential areas to the south and by Debdale Park and Sports Club to the west. The East Midlands Railway line runs through the centre of the site.</p>	<p>Poor</p>
<p>Developmental and Environmental Constraints (e.g. size; topography; site access; roads, lighting, landscaping, mains utilities and communications infrastructure; flood risk; contamination; nature and heritage conservation)</p>	<p>This is a small and awkward-shaped site with significant changes in levels adjacent to the railway line. The railway line intersects the site from north to south. The site has utilities and communications infrastructure in place.</p> <p>There is a cluster of listed buildings within 400m west of the site at Debdale Hall. There is also a cluster of listed buildings along Station Street within 400m east of the site. There are no environmental designations on or within close proximity to the site.</p> <p>The site is within Flood Zone 1 and therefore at low risk of flooding.</p>	<p>Poor</p>
<p>Barriers to Delivery and Mitigation (including ownership constraints - if known)</p>	<p>The site is fully developed and intersected by the railway line. No obvious barriers to redevelopment were evident from the site visit.</p>	<p>Average</p>
<p>Market Attractiveness (including appropriateness, vacancy and market activity on site for the type of development proposed)</p>	<p>A small, awkward-shaped brownfield site within a lower value area, close to busy junction and surrounded by residential uses. The units adjacent to the railway line are more modern and in good condition; however, the units off Grove Way were more dated with some in poor condition. The environment is poor and the site would benefit from investment in public realm, landscaping and upgrading. The site was occupied by a range of employment, leisure (use class E) and sui generis uses and vacancy levels were low. The site meets local demand for starter offices/workshops.</p>	<p>Average</p>
<p>Strategic Fit with Growth Area Objectives (by target Market Segment)</p>	<p>This site already accommodates key industrial growth sectors as identified in the D2N2 Vision 2030 document including professional/business services, healthcare and creative and digital.</p>	<p>Average</p>
<p>OVERALL SITE RATING</p>	<p>Average</p>	
<p>Recommendation and Potential Future Uses</p>	<p>Protect for employment uses (i.e. retain allocation as a key / general employment area)</p>	
<p>SITE SUMMARY:</p>		
<p>This is a small existing employment site adjacent to Mansfield Woodhouse Railway Station and intersected by the railway line. It is an awkward-shaped site with significant level changes, some</p>		

restricted local road access and surrounded by residential areas. The units adjacent to the railway line are more modern and in good condition however, the units off Grove Way were more dated with some in poor condition. The site is primarily occupied by employment uses with limited leisure (use class E) and sui generis uses, vacancy levels were low. The site meets local demand for starter offices/workshops with good proximity to urban areas and services. The site is designated as a key / general employment area in the Local Plan and it is recommended that the site is protected for employment uses.

Ransom Wood Business Park (Ref: MDC9)



**GROSS SITE AREA:
7.23 ha**

**ESTIMATED NET DEVELOPABLE
AREA:
1.61 ha**
*Note: Based on the HELAA sites discussed
below*

CRITERIA	COMMENT	RATING
<p>Site Context</p> <ul style="list-style-type: none"> • Location with regards to existing employment areas and other sites • How the site fits into the overall portfolio 	<p>This former hospital site is located within established woodland and has been successfully converted into a popular business park. It is within a wider industrial area along Southwell Road West (A6191) on the south-eastern outskirts of Mansfield. It is adjacent to the Ratcher Hill employment area, and in close proximity to the Sherwood Oaks Business Park.</p>	
<p>Local Plan Designation</p>	<p>The Development Plan for Mansfield comprises of the Mansfield District Local Plan 2013-2033 (Adopted September 2020). The site is designated as a Key / General Employment Area (Policy E31).</p>	
<p>Status in SHLAA</p>	<p>The HELAA (2017) identified a few smaller sites within the wider site as 'reasonable alternative' sites (site ref. 39a comprising of 1.35ha and site ref. 39b comprising of 0.26ha parking areas/grassland). However, the owner has stated there are no current plans for office development during the plan period as the focus is on developing other parts of the site for wider commercial uses.</p>	
<p>Planning History</p>	<p>There are a number of historical planning applications relating to the current uses on the site.</p>	
<p>Current Use and Land Type</p>	<p>This is a brownfield site occupied by a business park set within a woodland.</p>	
<p>Occupier Profile</p>	<p>The site is occupied by a number of detached office buildings.</p>	

<p>(if partly developed, including % of available land and levels of vacancy onsite)</p>	<p>Occupiers primarily include businesses within the professional and business services, creative and digital and healthcare industries. There is also a nursery, wellbeing centre and café/conference venue onsite.</p> <p>Tenants include:</p> <p>Creative Care (east Midlands) Ltd Finning (machinery supplier) BMI Healthcare ABL Health NHIS (National Health Interview Survey) A number of Hypnotherapy, Psychotherapy and Counselling providers. Rippon Homes (developer) Home Repair Network Limited BFS Accountants Skills Forward (software company) Eventure (web design) Education Mutual Brides and Mothers Designer Wedding Outlet Forever Green Café and Conference Venue Cedar House Day Nursery</p> <p>The site has a medium vacancy level, at the time of the site visit (November 2020) there were 25 office units of varying sizes available to let, comprising of a total of 2,454 sqm.</p>	
<p>Strategic Road Access</p>	<p>The site is accessed via the A6191 to the South West. The A6191 continues 4.3km North West to the A60 and Junction 28 of the M1 is 14.6km West of the site via the A617 and A38.</p>	<p>Average</p>
<p>Local Road Access</p>	<p>The site can be accessed via the A6191 which is a good free-moving road heading North West towards Mansfield and South East towards the B6020 (Mansfield Road) and the A617. The B6020 continues South East towards Rainworth. The A617 continues East towards Newark-on-Trent and West towards Sutton-in-Ashfield.</p>	<p>Very Good</p>
<p>Proximity to Urban Areas and Access to Labour and Services (including public transport / cycling / walking accessibility)</p>	<p>The site is located on the south-eastern outskirts of Mansfield. Mansfield town centre provides a wide range of facilities and services including schools, medical services, shops, recreational facilities and a police station. The residential suburb of Berry Hill is located to the south west of the site. The site is also to the east of Oak Tree Lane and surrounding residential area, as well as the Tesco Extra. The site is located 1.6 km North West of Rainworth village via the A6191 and B6020 which provides schools, a health centre, local shops, post office and takeaway.</p> <p>The site is serviced by regular bus services via</p>	

	<p>stops on the A6191 travelling South East (towards Nottingham and Rainworth, and less frequent services to Newark, Blidworth, Bilsthorpe and Eakring) and North West (towards Mansfield and Sutton in Ashfield).</p> <p>Mansfield railway station is 5km away and is serviced by regular bus stops on the A6191.</p>	
Compatibility of Adjoining Uses (including amenity impacts experienced by current/future occupiers and neighbouring areas)	The site is densely bordered by mature trees with greenfield land beyond to the North/East, Mansfield Asphalt plant to the North/West and a solar farm to the South East.	Very Good
Developmental and Environmental Constraints (e.g. size; topography; site access; roads, lighting, landscaping, mains utilities and communications infrastructure; flood risk; contamination; nature and heritage conservation)	<p>This is a relatively level site set within a dense woodland, utilities and communications infrastructure is in place. The site is accessed via internal spine roads from the A6191.</p> <p>The site is within Flood Zone 1 and therefore at low risk of flooding. There are no heritage designations within or in close proximity to the site.</p> <p>Strawberry Hill Heaths SSSI is approximately 400m north of the site. Oak Tree Heath Local Nature Reserve is approximately 650m north east of the site.</p>	Very Good
Barriers to Delivery and Mitigation (including ownership constraints - if known)	<p>There are a couple of small undeveloped sites within the business park which could accommodate limited sensitive development subject to availability being confirmed by the landowner.</p> <p>No other constraints to redevelopment were apparent from the site visit.</p>	Very Good
Market Attractiveness (including appropriateness, vacancy and market activity on site for the type of development proposed)	This is a successful business park set within an established woodland on the outskirts of Mansfield. The site provides facilities for businesses including a nursery, café and conference centre and a wellbeing centre. There were a reasonable number of vacancies at the time of the site visit and some older buildings would benefit from investment.	Good
Strategic Fit with Growth Area Objectives (by target Market Segment)	This site already accommodates key industrial growth sectors as identified in the D2N2 Vision 2030 document including professional/business services, creative and digital and healthcare.	Good
OVERALL SITE RATING	Good	
Recommendation and Potential Future Uses	<p>Allocate for employment uses (i.e. retain allocation as a key / general employment area)</p> <p>There is potential scope for mixed use development E, B2, C1</p>	

on small undeveloped sites within the designation.

SITE SUMMARY:

This former hospital site is located within established woodland and has been successfully converted into a popular business park. It is within a wider industrial area along Southwell Road West (A6191) on the south-eastern outskirts of Mansfield. It is adjacent to the Ratcher Hill employment area and in close proximity to the Sherwood Oaks Business Park. The site is primarily occupied by businesses within the professional and business services, creative and digital and healthcare industries. There is also a nursery, wellbeing centre and café/conference venue onsite.

There were a reasonable number of vacancies at the time of the site visit. There are a couple of small undeveloped sites within the business park which could accommodate limited sensitive development subject to availability being confirmed by the landowner. The site is designated as a key / general employment area in the Local Plan and it is recommended that the site is allocated for employment uses. There is potential scope for mixed use development E, B2, C1 on small undeveloped sites within the designation.

Bellamy Road Industrial Estate (Ref: MDC10)

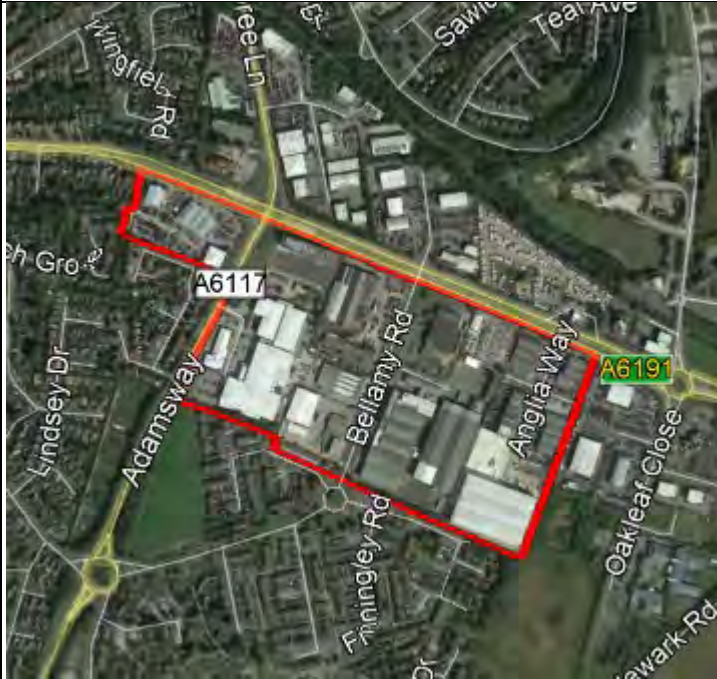

**GROSS SITE AREA:
19.54 ha**

**ESTIMATED NET DEVELOPABLE
AREA:
0 ha**

CRITERIA	COMMENT	RATING
<p>Site Context</p> <ul style="list-style-type: none"> • Location with regards to existing employment areas and other sites • How the site fits into the overall portfolio 	<p>This is a well-established industrial estate within a wider industrial area along Southwell Road West (A6191) on the south-eastern outskirts of Mansfield.</p> <p>It is adjacent to Sherwood Oaks Business Park and Oak Tree Business Park and also in close proximity to Ransom Wood Business Park and Ratcher Hill employment area.</p>	
<p>Local Plan Designation</p>	<p>The Development Plan for Mansfield comprises of the Mansfield District Local Plan 2013-2033 (Adopted September 2020). The site is designated as a Key / General Employment Area (Policy E3m).</p>	
<p>Status in SHLAA</p>	<p>The HELAA (2017) identified a site within the wider site as 'reasonable alternative' site (ref. 37); this is now occupied by a new Linney building. Another site within the wider site (ref. 138) was excluded at Stage 2 as permission for employment uses had been implemented.</p>	
<p>Planning History</p>	<p>Recent planning history includes:</p> <ul style="list-style-type: none"> • 2018/0762/FUL – Full planning application – New Warehouse (B8) Including Reception, Changing Facilities, Ancillary Office Space and Mezzanine Pick and Pack Facility. Hard and Soft Landscaping including service yard and parking for 118 vehicles – Resubmission of Planning Application • 2018/0157/FUL for (New Warehouse with Associated Facilities and Office Space, Parking and Servicing Areas) – Granted 29.01.2019 • 2014/0684/ST – Full planning application – Erection 	

	of a commercial unit for the Storage, Repair and Sales of Caravans and Motorhomes (Use classes B1, B2 and B8) – Granted 18.02.2015	
Current Use and Land Type	This is a brownfield site occupied by an industrial estate.	
Occupier Profile (if partly developed, including % of available land and levels of vacancy onsite)	<p>The site is part occupied by Linney marketing agency. There is a cluster of car salesrooms along Southwell Road West (A6191) including a Nissan and Citroen dealer on this site as well as the Pendragon Training Centre (automotive retail).</p> <p>Other occupiers of the site include Briggs Metals (scrap metal processing), Alton Cars (vehicle repairs) and Premier Self Storage. There is also The South Mansfield Christian Fellowship church located on Bellamy Road. There are a number of smaller workshop units off Anglia Way.</p> <p>At the time of the site visit (November 2020) all units appeared to be occupied.</p>	
Strategic Road Access	The site is adjacent to and accessed from Southwell Road West (A6191). The A6191 joins the A617 approximately 1km east of the site. The A6191 continues 3km North West to the A60 and Junction 28 of the M1 is 14.1km West of the site via the A617 and A38.	Average
Local Road Access	The site is accessed via Southwell Road West (A6191) to the north, Bellamy Road to the north and south, and Adamsway (A6117) to the west. The A6191 and A6117 are good, free-flowing roads with the former heading North West towards Mansfield and South East towards the B6020 (Mansfield Road) and the A617. Bellamy Road and Anglia Way branch off Southwell Road West. Bellamy Road is a smaller, predominantly residential road which also leads to residential areas.	Very Good
Proximity to Urban Areas and Access to Labour and Services (including public transport / cycling / walking accessibility)	<p>The site is located on the south-eastern outskirts of Mansfield. Mansfield town centre provides a wide range of facilities and services including schools, medical services, shops, recreational facilities and a police station.</p> <p>The residential suburb of Berry Hill is located to the west of the site. The site is also to the south of Oak Tree Lane and surrounding residential area, as well as the Tesco Extra. The site is located 2.4km North West of Rainworth village via the A6191 and B6020 which provides schools, a health centre, local shops, post office and takeaway.</p> <p>The site is serviced by regular bus services via</p>	Average / Good

	<p>stops on the A6191 travelling South East (towards Nottingham and Rainworth, and less frequent services to Newark, Blidworth, Bilsthorpe and Eakring) and North West (towards Mansfield and Sutton in Ashfield).</p> <p>Mansfield railway station is 4.5km away and is serviced by regular bus stops on the A6191. There are also bus stops on Bellamy Road.</p>	
<p>Compatibility of Adjoining Uses (including amenity impacts experienced by current/future occupiers and neighbouring areas)</p>	<p>The site is bordered by the A6191 to the north, with car salesrooms and employment uses beyond, by Sherwood Oaks Business Park to the east, by residential areas to the south and Adamsway (A6117) to the west with residential areas beyond.</p>	Average
<p>Developmental and Environmental Constraints (e.g. size; topography; site access; roads, lighting, landscaping, mains utilities and communications infrastructure; flood risk; contamination; nature and heritage conservation)</p>	<p>This is a large site with access from Southwell Road West, Adamsway and Bellamy Road, utilities and communications infrastructure are already in place.</p> <p>The site slopes gently from north to south and is within Flood Zone 1 and therefore at low risk of flooding. There are no heritage or environmental designations within or adjacent to the site.</p>	Very Good
<p>Barriers to Delivery and Mitigation (including ownership constraints - if known)</p>	<p>The site is fully developed and no other constraints to redevelopment were apparent from the site visit.</p>	Very Good
<p>Market Attractiveness (including appropriateness, vacancy and market activity on site for the type of development proposed)</p>	<p>This is a large site within the main urban area of Mansfield. It is highly visible from Southwell Road West and is occupied by a range of employment uses and has low vacancy levels. The area would benefit from investment in public realm, boundaries and landscaping to improve its kerb appeal.</p>	Good
<p>Strategic Fit with Growth Area Objectives (by target Market Segment)</p>	<p>This site already accommodates key industrial growth sectors as identified in the D2N2 Vision 2030 document including professional/business services, creative & digital and retail.</p>	Good
<p>OVERALL SITE RATING</p>	<p>Good</p>	
<p>Recommendation and Potential Future Uses</p>	<p>Protect for employment uses (i.e. retain allocation as a key / general employment area)</p>	
<p>SITE SUMMARY:</p> <p>This is a well-established industrial estate within a wider industrial area along Southwell Road West (A6191) on the south-eastern outskirts of Mansfield. The site is primarily occupied by Linney Group. There is a cluster of car salesrooms along Southwell Road West (A6191) including a Nissan and Citroen dealer on this site as well as the Pendragon Training Centre, the site has low vacancy levels. The site is designated as a key / general employment area in the Local Plan and it</p>		

is recommended that the site is protected for employment uses.

Hermitage Lane Industrial Estate (Ref: MDC11)



GROSS SITE AREA:
11.29 ha

ESTIMATED NET DEVELOPABLE AREA:
0 ha

CRITERIA	COMMENT	RATING
<p>Site Context</p> <ul style="list-style-type: none"> • Location with regards to existing employment areas and other sites • How the site fits into the overall portfolio 	<p>This is a well-established industrial estate within a wider industrial area on the south-western outskirts of Mansfield. It is adjacent to the Oakham Business Park and the new Amazon distribution centre at Summit Park is approximately 200m to the south.</p>	
<p>Local Plan Designation</p>	<p>The Development Plan for Mansfield comprises of the Mansfield District Local Plan 2013-2033 (Adopted September 2020). The site is designated as a Key / General Employment Area (Policy E3n).</p>	
<p>Status in SHLAA</p>	<p>The HELAA (2017) identified smaller sites within the site as 'reasonable alternative' consent sites (refs. 140, 212 and 215).</p>	
<p>Planning History</p>	<p>Recent planning history includes:</p> <ul style="list-style-type: none"> • 2016/0086/ST – Full planning application – Erection of 3 No. Light Industrial/Distribution Units (Use Class B1/B2/B8) – Granted 17.05.2016 • 2017/0155/FUL – Full planning application - New Light Industrial Unit – Granted 08.05.2017 • 2017/0850/FUL – Full planning application – 1 No. New Industrial Unit – Granted 22.02.2018 • 2018/0473/FUL – Full planning application – 1 No. New Attached Industrial Unit – Granted 14.08.2018 	
<p>Current Use and Land Type</p>	<p>This is a brownfield site occupied by an established industrial estate.</p>	
<p>Occupier Profile (if partly developed, including % of</p>	<p>This site is fully developed and occupied by a range of uses including:</p>	

<p>available land and levels of vacancy onsite)</p>	<p>UK Power Reserve Electricity Regeneration Plant; Abbey Trade Park – accommodating Screwfix, Travis Perkins, Tool Station, Edmundson Electrical and other homewares retailers; Tool Hire Express; Status Scientific Dynamant (scientific equipment supplier); T4 Design Glass Processors; and QRMS (recycling centre). There are a number of smaller trade units, including some relatively modern units.</p> <p>Overall, the site has good occupancy and at the time of the site visit (November 2020) there were only a few vacant units:</p> <p>A detached office/workshop unit of 363 sqm; and Three modern trade counter units which can be combined to comprise of a total of 778 sqm.</p>	
<p>Strategic Road Access</p>	<p>The A38 is approximately 500m north of the site via Hermitage Lane and the A617 is approximately 500m south of the site. The site is 1km from the A60 heading south east. The site is 9.1km from junction 28 of the M1 via the A617 and A38. The A617 and A38 are good, free-moving roads with the later providing direct access to Mansfield to the North East and Sutton-in-Ashfield to the West.</p>	<p>Poor / Average</p>
<p>Local Road Access</p>	<p>The site is accessed from east via Hermitage Lane which meets the A38 after 0.5km. Hermitage Lane access is constrained by a restricted-height railway bridge (max height 4.0m) which passes over the road approximately 200m north of the site. The A617 and A38 are good, free-moving roads with the later providing direct access to Mansfield to the North East and Sutton-in-Ashfield to the West.</p>	<p>Good</p>
<p>Proximity to Urban Areas and Access to Labour and Services (including public transport / cycling / walking accessibility)</p>	<p>The site is located on the South West outskirts of Mansfield centre which is 3.2km from the site via the A38. The town of Sutton-in-Ashfield is approximately 4km to the west of the site via the A617 and B6023.</p> <p>Mansfield and Sutton-in-Ashfield both provide a wide range of facilities and services including schools, medical services and shops. Mansfield also provides a range of recreational facilities and a police station.</p> <p>The Site is not serviced by regular public transport services, the closest regular bus services are accessed via stops on the A38 0.5km from the site. Buses from the A38 travel South/West towards Sutton-in-Ashfield, Nottingham, South</p>	<p>Good</p>

	<p>Normanton and Derby and North East towards Mansfield.</p> <p>Mansfield railway station is approximately 2.4km away and is serviced by regular buses from the A38.</p> <p>The Timberland Trail footpath adjoins the site boundary to the south and west.</p>	
<p>Compatibility of Adjoining Uses (including amenity impacts experienced by current/future occupiers and neighbouring areas)</p>	<p>The site is bordered by the East Midlands Railway line and the River Maun to the North/West with residential areas beyond to the North and greenfield land and reservoir beyond to the West. There are further industrial units bordering the site to the South and East.</p>	Very Good
<p>Developmental and Environmental Constraints (e.g. size; topography; site access; roads, lighting, landscaping, mains utilities and communications infrastructure; flood risk; contamination; nature and heritage conservation)</p>	<p>This is a large established industrial estate with access from Hermitage Lane and internal spine roads, utilities and communications infrastructure already in place.</p> <p>The site slopes gently from north to south. The majority of the site is within Flood Zone 1 and therefore at low risk of flooding, apart from a small area at the northern boundary within Flood Zone 2.</p> <p>Hermitage Mill immediately north of the site is grade II listed (ref. 1288578) and the railway bridge 100 metres west of Hermitage Mill is also grade II listed (ref. 1207169). The Hermitage Local Nature Reserve and King's Mill Viaduct scheduled monument are to the west of the site and the Oakham Local Nature Reserve is to the east of the site.</p>	Good
<p>Barriers to Delivery and Mitigation (including ownership constraints - if known)</p>	<p>The site is fully developed and no other barriers to redevelopment were evident from the site visit.</p>	Good
<p>Market Attractiveness (including appropriateness, vacancy and market activity on site for the type of development proposed)</p>	<p>This is a large site within the main urban area of Mansfield. It is occupied by a range of employment uses and has low vacancy levels. The area would benefit from investment in public realm, boundaries and landscaping.</p>	Average
<p>Strategic Fit with Growth Area Objectives (by target Market Segment)</p>	<p>This site already accommodates key industrial growth sectors as identified in the D2N2 Vision 2030 document including construction and retail.</p>	Average
<p>OVERALL SITE RATING</p>	<p>Good</p>	
<p>Recommendation and Potential Future Uses</p>	<p>Protect for employment uses (i.e. retain allocation as a key / general employment area)</p>	

SITE SUMMARY:

This is a well-established industrial estate within the Mansfield urban area, to the south of the town centre and within the wider Hamilton Way/Hermitage Lane industrial area. It is primarily occupied by construction industries, and trade counters. The site would benefit from improvements to bus services and investment in public realm. The site is designated as a key / general employment area in the Local Plan and it is recommended that the site is protected for employment uses.

Maunside, Hermitage Lane (Ref: MDC12)



**GROSS SITE AREA:
9.84 ha**

**ESTIMATED NET DEVELOPABLE
AREA:
0 ha**

CRITERIA	COMMENT	RATING
<p>Site Context</p> <ul style="list-style-type: none"> • Location with regards to existing employment areas and other sites • How the site fits into the overall portfolio 	<p>This is a well-established industrial estate within a wider industrial area on the south-western outskirts of Mansfield. It is adjacent to Oakham Business Park and the new Amazon distribution centre at Summit Park is approximately 200m to the south.</p>	
<p>Local Plan Designation</p>	<p>The Development Plan for Mansfield comprises of the Mansfield District Local Plan 2013-2033 (Adopted September 2020). The site is designated as a Key / General Employment Area (Policy E3o).</p>	
<p>Status in SHLAA</p>	<p>The HELAA (2017) identified the site as a 'reasonable alternative' consent site (ref. 123).</p>	
<p>Planning History</p>	<p>Recent planning history relates to the employment uses onsite.</p>	
<p>Current Use and Land Type</p>	<p>This is a brownfield site occupied by an established industrial estate.</p>	
<p>Occupier Profile (if partly developed, including % of available land and levels of vacancy onsite)</p>	<p>This site is fully developed and occupied by a range of B2/B8 units, smaller trade units and offices as well as waste and recycling centres.</p> <p>Occupiers include:</p> <p>Mansfield District Council Trade Waste Services Hermitage Lane Depot Mansfield Household Recycling Centre Greenline Industrial Estate – occupiers include Protrade</p>	

	<p>Depot, Crown Paints, Craft Signs, Virgin Media, Autoglass, Wolseley Willbond Plumbing Centre Booker Wholesale Cash and Carry Polyframe Trade Doors Mitchells Ironmongers Mansfield Tyres Webeye Limited (CCTV supplier) Peaceful Trust (Charity shop)</p> <p>At the time of the site visit (November 2020) all units appeared to be occupied.</p>	
Strategic Road Access	<p>The A38 is approximately 500m north of the site via Hermitage Lane and the A617 is approximately 500m south of the site. The site is 1km from the A60 heading south east. The site is 9.1km from junction 28 of the M1 via the A617 and A38. The A617 and A38 are good, free-moving roads with the later providing direct access to Mansfield to the North East and Sutton-in-Ashfield to the West.</p>	Poor / Average
Local Road Access	<p>The site is accessed from the west via Hermitage Lane which meets the A38 after 0.5km. Hermitage Lane access is constrained by a restricted-height railway bridge (max height 4.0m) which passes over the road approximately 200m north of the site. The A617 and A38 are good, free-moving roads with the later providing direct access to Mansfield to the North East and Sutton-in-Ashfield to the West. The site has multiple internal spine roads – Maunside, Melton Way and Kestral Road.</p>	Good
Proximity to Urban Areas and Access to Labour and Services (including public transport / cycling / walking accessibility)	<p>The site is located on the South West outskirts of Mansfield centre which is 3.2km from the site via the A38. The town of Sutton-in-Ashfield is approximately 4km to the west of the site via the A617 and B6023. Mansfield and Sutton-in-Ashfield both provide a wide range of facilities and services including schools, medical services and shops. Mansfield also provides a range of recreational facilities and a police station.</p> <p>The site is not serviced by regular public transport services, the closest regular bus services are accessed via stops on the A38 0.5km from the site. Buses from the A38 travel South/West towards Sutton-in-Ashfield, Nottingham, South Normanton and Derby and North East towards Mansfield.</p> <p>Mansfield railway station is approximately 2.4km</p>	Good

	<p>away and is serviced by regular buses from the A38.</p> <p>The Timberland Trail footpath adjoins the site boundary to the south.</p>	
<p>Compatibility of Adjoining Uses (including amenity impacts experienced by current/future occupiers and neighbouring areas)</p>	<p>The site is bordered to the North by the Oakham Local Nature Reserve with the River Maun and Mansfield concrete plant beyond, and further industrial units to the South, East and West.</p>	Very Good
<p>Developmental and Environmental Constraints (e.g. size; topography; site access; roads, lighting, landscaping, mains utilities and communications infrastructure; flood risk; contamination; nature and heritage conservation)</p>	<p>This is a large established industrial estate with access from Hermitage Lane and internal spine roads, utilities and communications infrastructure already in place.</p> <p>The site slopes gently from north to south. The majority of the site is within Flood Zone 1 and therefore at low risk of flooding. However, there is a small area off Maun Way within Flood Zones 2 and 3.</p> <p>The Oakham Local Nature Reserve bounds the site to the north. Hermitage Mill immediately west of the site is grade II listed (ref. 1288578). The railway bridge 100 metres west of Hermitage Mill is also grade II listed (ref. 1207169). The Hermitage Local Nature Reserve and King's Mill Viaduct scheduled monument are within 500m of the site. Matlock Mill Joinery works is approximately 250m east of the site and is grade II listed (ref. 1279862).</p>	Average
<p>Barriers to Delivery and Mitigation (including ownership constraints - if known)</p>	<p>The site is fully developed and no other barriers to redevelopment were evident from the site visit.</p>	Average
<p>Market Attractiveness (including appropriateness, vacancy and market activity on site for the type of development proposed)</p>	<p>This is a large site within the main urban area of Mansfield. It is occupied by a range of employment uses and has low vacancy levels.</p>	Average
<p>Strategic Fit with Growth Area Objectives (by target Market Segment)</p>	<p>This site already accommodates key industrial growth sectors as identified in the D2N2 Vision 2030 document including construction, professional/business services and retail.</p>	Average
<p>OVERALL SITE RATING</p>	<p>Good</p>	
<p>Recommendation and Potential Future Uses</p>	<p>Protect for employment uses (i.e. retain allocation as a key / general employment area)</p>	
<p>SITE SUMMARY:</p>		

This is a well-established industrial estate within a wider industrial area on the south-western outskirts of Mansfield. It is adjacent to Oakham Business Park and the new Amazon distribution centre at Summit Park is approximately 200m to the south. The site has low vacancy levels and accommodates key industrial growth sectors including construction, professional/business services and retail. There are also recycling and waste depots and a charity shop on the site. The site would benefit from improvements to bus services and investment in public realm. The site is designated as a key / general employment area in the Local Plan and it is recommended that the site is protected for employment uses.

Ratcher Hill Employment Area and Quarry (Ref: MDC13)



**GROSS SITE AREA:
7.25 ha**

**ESTIMATED NET DEVELOPABLE AREA:
3.45 ha**

CRITERIA	COMMENT	RATING
<p>Site Context</p> <ul style="list-style-type: none"> • Location with regards to existing employment areas and other sites • How the site fits into the overall portfolio 	<p>This site comprises of the existing Ratcher Hill Employment Area to the south and the allocated extension to the north. To the south there are a couple of detached office buildings adjacent to the A6191, the former NHS Mansfield and Ashfield CCG Birch House Offices to the east, a storage compound and a former under 17s driving area and the Breedon Mansfield Asphalt Plant to the north.</p> <p>The site is within a wider industrial area along Southwell Road West (A6191) on the south-eastern outskirts of Mansfield. It is adjacent to the Ransom Wood Business Park and Oak Tree Business Park, and in close proximity to the Sherwood Oaks Business Park, and Bellamy Road Industrial Estate.</p>	
<p>Local Plan Designation</p>	<p>The Development Plan for Mansfield comprises of the Mansfield District Local Plan 2013-2033 (Adopted September 2020). The Ratcher Hill Employment Area to the south is designated as a Key / General Employment Area (Policy E3s).</p> <p>The land occupied by the Breedon Mansfield Asphalt Plant to the north is designated as a new employment area – Ratcher Hill Quarry Employment Area (Policy E2a), a 3.45 ha extension to the Ratcher Hill Employment Area for office, warehousing and industrial development.</p>	
<p>Status in SHLAA</p>	<p>The HELAA (2017) identified the land to the north of the former NHS Birch House offices as a ‘reasonable alternative’ site (site ref. 38 comprising of 2.07 ha). The site is understood to be available for development and car park proposals would comprise 0.61 ha; however, land stability issues may restrict development of the remaining site area.</p>	

	<p>The HELAA also identified land south of the driving track (site ref. 151) comprising of 0.22 ha of carparking. However, the landowners indicated the site was no longer available and it was excluded at Stage 2.</p>	
Planning History	<p>Recent planning applications include:</p> <ul style="list-style-type: none"> • 2019/0445/COU - Mills Extreme Vehicles Ratcher Hill - Change of use from workshop (B1, B2 AND B3 use) to gymnastics centre (D2 use) – Granted 06.11.2019 • This application is outside the site boundary but immediately adjacent to the south-east: 2019/0019/FUL - Vacant Plot Of Land To The South Of Ransom Wood, Northeast Of The Roundabout At A6191 And Sherwood Avenue - the erection of four buildings comprising 2no. Restaurant / drive-thrus (class A3/A5); a restaurant (class A3); and a vehicle rental unit (sui generis) with associated vehicular access, parking, servicing, landscaping and associated works. - resubmission. – Granted 03.07.2020 	
Current Use and Land Type	<p>This is a brownfield site occupied by office buildings, storage land, a former driving practice track and an Asphalt Plant.</p>	
Occupier Profile (if partly developed, including % of available land and levels of vacancy onsite)	<p>Occupiers include the Breedon Mansfield Asphalt Plant, Persimmon Homes Nottingham Office, a storage compound and a former under 17s driving area.</p> <p>At the time of the site visit (November 2020) there was an office to let – Fountain House first floor comprising of 500sqm. The former driving practice track site was also available, it comprises of 1.64 ha of land suitable for vehicle storage or other employment uses subject to planning. Since the site visit, it is understood that the NHS Mansfield and Ashfield CCG Birch House Offices have also become vacant.</p>	
Strategic Road Access	<p>The site is accessed via the A6191 to the South. The A6191 continues 3.4km North West to the A60 and Junction 28 of the M1 is 15.2km West of the site via the A617 and A38.</p>	Average
Local Road Access	<p>The site can be accessed via the A6191 which is a good free-moving road heading North West towards Mansfield and South East towards the B6020 (Mansfield Road) and the A617. The B6020 continues South East towards Rainworth. The A617 continues East towards Newark-on-Trent and West towards Sutton-in-Ashfield.</p>	Very Good
Proximity to Urban Areas and Access to Labour and Services (including public transport / cycling / walking accessibility)	<p>The site is located on the south-eastern periphery of Mansfield. Mansfield town centre provides a wide range of facilities and services including schools, medical services, shops, recreational facilities and a police station. Mansfield railway station is 5.3km away and is serviced by regular</p>	

	<p>buses from the A6191 and A6117.</p> <p>The site is 2km North West of Rainworth village via the A6191 and B6020 which provides schools, a health centre, local shops, post office and takeaway.</p> <p>The Site is serviced by regular bus services via stops on the A6191 travelling South East (towards Nottingham and Rainworth, and less frequent services to Newark, Blidworth, Bilsthorpe and Eakring) and North West (towards Mansfield and Sutton in Ashfield).</p>	
<p>Compatibility of Adjoining Uses (including amenity impacts experienced by current/future occupiers and neighbouring areas)</p>	<p>The site is bordered to the North by the wider Ratcher Hill quarry site and Jubilee Way South and residential/commercial areas, to the East by Ransom Wood Business Park, to the South by the A6191, to the West by a caravan storage park.</p>	Good
<p>Developmental and Environmental Constraints (e.g. size; topography; site access; roads, lighting, landscaping, mains utilities and communications infrastructure; flood risk; contamination; nature and heritage conservation)</p>	<p>This site comprises of an Asphalt Plant to the north with employment and leisure uses to the south with utilities and communications infrastructure in place. There are significant level changes in the northern area of the site and potential ground stability and contaminated land issues.</p> <p>The site is accessed via internal spine roads from the A6191.</p> <p>The site is within Flood Zone 1 and therefore at low risk of flooding. There are no heritage designations within or in close proximity to the site.</p> <p>Strawberry Hill Heaths SSSI and Oak Tree Heath Local Nature Reserve are within 750m of the site to the north.</p>	Poor
<p>Barriers to Delivery and Mitigation (including ownership constraints - if known)</p>	<p>There may be some ground stability / contaminated land issues associated with the quarry immediately north of the site limiting the area available for redevelopment.</p> <p>Land to the north of the former NHS Birch House comprising of 2.07 ha is understood to be available for development; however, land stability issues may restrict development of the remaining site area to 0.61 ha.</p> <p>In addition, a small area (0.22ha comprising of carparking) was identified in the HELAA however, the landowners indicated the site was no longer available.</p> <p>The former driving track was on the market at the</p>	Average / Poor

	time of the site visit, advertised for vehicle storage uses and has potential for redevelopment.	
Market Attractiveness (including appropriateness, vacancy and market activity on site for the type of development proposed)	This site is adjacent to the A6191 and the successful Ransom Wood Business Park. It is an important employment area in a high-profile location. Vacancy levels were low at the time of the site visit. The site would benefit from investment in public realm particularly near its interface with the existing quarry.	Average
Strategic Fit with Growth Area Objectives (by target Market Segment)	This site already accommodates key industrial growth sectors as identified in the D2N2 Vision 2030 document including extractive industries, professional/business services, and healthcare.	Average
OVERALL SITE RATING	Average	
Recommendation and Potential Future Uses	Allocate for employment uses (i.e. retain allocation for key / general employment area to the south, and Ratcher Hill Quarry Employment Area (Policy E2a) to the north east)	
SITE SUMMARY:		
<p>This site comprises of the existing Ratcher Hill Employment Area to the south and the allocated extension to the north. To the south there are a couple of detached office buildings adjacent to the A6191, the former NHS Mansfield and Ashfield CCG Birch House Offices to the east, a storage compound, a former under 17's driving area and the Breedon Mansfield Asphalt Plant. At the time of the site visit an office unit and the former driving practice track were on the market. Since then, the Birch House offices have also become vacant. The former driving track and land to the north of Birch House offices have potential for redevelopment subject assessing ground stability. The site would benefit from investment in public realm particularly near its interface with the existing quarry. The southern portion of the site is designated as a key / general employment area and the land currently in use by Breedon Mansfield Asphalt Plant to the north is designated as a new employment area (E2a). It is recommended that the site is allocated for employment uses.</p>		

Bleaks Hill (Ref: MDC14)



GROSS SITE AREA:
6.08 ha

ESTIMATED NET DEVELOPABLE AREA:
0 ha

CRITERIA	COMMENT	RATING
<p>Site Context</p> <ul style="list-style-type: none"> • Location with regards to existing employment areas and other sites • How the site fits into the overall portfolio 	<p>This is an existing employment site within the Mansfield urban area and to the south-west of the town centre. It is adjacent to the Hamilton Way / Hermitage Lane industrial area.</p>	
<p>Local Plan Designation</p>	<p>The Development Plan for Mansfield comprises of the Mansfield District Local Plan 2013-2033 (Adopted September 2020). The site is designated as a Key / General Employment Area (Policy E3t).</p>	
<p>Status in SHLAA</p>	<p>N/A</p>	
<p>Planning History</p>	<p>Recent applications include:</p> <ul style="list-style-type: none"> • 2019/0320/COU - Change of use of storage units (use class B8) to dog day care (use class sui generis) at Unit 3, 4 And 6 Halls Work Space Hermitage Lane. • 2019/0324/FUL - Demolish existing building and erect two storey building for storage (use class B8) and offices (use class B1a) at Land At Bleak Hill Sidings • 2018/0449/NCC - Variation of condition 2 of planning permission ref 2/2011/0307/ST to erect a new storage bay for construction waste on same footprint. Full planning permission for new wash down area and drainage at A B Waste Disposal Limited Bleak Hill Sidings. • 2017/0261/NCC - Town and Country Planning (development management procedure) (England) Order 2015 - notice under article 18 consultation on planning application - proposed replacement facilities cabin, 	

	providing office accommodation, wc and restroom at A B Waste Disposal Limited Bleak Hill Sidings.	
Current Use and Land Type	This is a brownfield site occupied by employment uses.	
Occupier Profile (if partly developed, including % of available land and levels of vacancy onsite)	<p>This site is fully developed and occupied by:</p> <p>Cemex Mansfield Concrete Plant Environmental Coatings (construction) Cash & Carry Windows Trade Counter Wernick Hire (portable building manufacturer) WH Paint Finishers Ltd AB Waste Disposal (skip hire) AS Plant Limited (civil engineering and groundworks) Intex Facades (siding contractor) H Mills & Sons (electrician) 100vans.com salesroom J&S Trade Car Centre Mansfield Doggy Day Care</p> <p>All the units appeared to be occupied at the time of the site visit (November 2020).</p> <p>This a poor-quality employment area, which nevertheless serves an important role in providing 'bad neighbour' space for uses such as recycling and concrete mixing/ open storage.</p>	
Strategic Road Access	The A38 is approximately 500m north of the site via Hermitage Lane and Sheepbridge Lane. The site is 1km from the A60 heading North East and 1km from the A617 heading South West. The site is 10km from junction 28 of the M1 via the A617 and A38. The A617 and A38 are good, free-moving roads with the later providing direct access to Mansfield to the North East and Sutton-in-Ashfield to the West.	Poor
Local Road Access	<p>The site is accessed from the North East via Sheepbridge Lane, and from the West via Hermitage Lane. Access arrangements to the site are poor from Sheepbridge Lane with unmade roads. Sheepbridge Lane access is constrained by a restricted-height railway bridge (max height 3.3m) which passes over the road approximately 0.1km from the site. The turning into the site from Sheepbridge Lane is difficult.</p> <p>Hermitage Lane access is also constrained by a restricted-height railway bridge (max height 4.0m) which passes over the road approximately 0.2km from the site.</p>	Poor
Proximity to Urban Areas and	The site is located on the South West outskirts of	Average

<p>Access to Labour and Services (including public transport / cycling / walking accessibility)</p>	<p>Mansfield centre which is 2.4km from the site via the A38. The town of Sutton-in-Ashfield is approximately 4.2km to the west of the site via the A38 and B6023.</p> <p>Mansfield and Sutton-in-Ashfield both provide a wide range of facilities and services including schools, medical services and shops. Mansfield also provides a range of recreational facilities and a police station.</p> <p>The site is not serviced by regular public transport services, the closest regular bus services are accessed via stops on the A38 which is 0.5km from the site. Buses from the A38 travel South/West towards Sutton-in-Ashfield, Nottingham, South Normanton and Derby and North East towards Mansfield.</p> <p>Mansfield railway station is approximately 2km away and is serviced by regular buses from the A38.</p>	
<p>Compatibility of Adjoining Uses (including amenity impacts experienced by current/future occupiers and neighbouring areas)</p>	<p>The site is bordered by the East Midlands Railway line to the North with residential areas beyond, to the east by Sheepsbridge Lane with allotments beyond, to the south by the River Maun and Hamilton Local Nature Reserve with the Hermitage Lane / Hamilton Way industrial area beyond and to the west by Hermitage Lane.</p>	Average
<p>Developmental and Environmental Constraints (e.g. size; topography; site access; roads, lighting, landscaping, mains utilities and communications infrastructure; flood risk; contamination; nature and heritage conservation)</p>	<p>This is a small employment site with existing utilities and communications infrastructure. The site slopes up to the north and is bound by the railway line to the north and the River Maun with the Oakham Local Nature Reserve beyond to the south.</p> <p>The site is within Flood Zone 1 and therefore at low risk of flooding. A small section at the south west corner of the area lies within Flood Zone 3.</p> <p>Matlock Mill Joinery Works immediately east of the site is Grade II listed (ref. 1279862) and Hermitage Mill immediately west of the site is grade II listed (ref. 1288578). The railway bridge 100 metres west of Hermitage Mill is also grade II listed (ref. 1207169). The Hermitage Local Nature Reserve and King's Mill Viaduct scheduled monument are within 500m of the site.</p>	Average
<p>Barriers to Delivery and Mitigation (including ownership constraints - if known)</p>	<p>The site is fully developed and no other barriers to redevelopment were evident from the site visit.</p>	Average
<p>Market Attractiveness (including appropriateness, vacancy)</p>	<p>This is a small site within the main urban area of Mansfield. It is occupied by a range of</p>	Average

and market activity on site for the type of development proposed)	employment uses and has low vacancy levels. It is a poor-quality employment area which nevertheless fulfils an important local role.	
Strategic Fit with Growth Area Objectives (by target Market Segment)	This site already accommodates key industrial growth sectors as identified in the D2N2 Vision 2030 document including construction.	Average
OVERALL SITE RATING	Average	
Recommendation and Potential Future Uses	Protect for employment uses (i.e. retain allocation as a key / general employment area).	
SITE SUMMARY:		
<p>This is an existing employment site within the Mansfield urban area, to the south of the town centre and adjacent to the Hamilton Way/Hermitage Lane industrial area. It is primarily occupied by construction industries, car sales showrooms and a doggy day care centre. The overall quality of the estate is poor owing to the nature of the uses. The area would benefit from investment in public realm, formation of roads and landscaping. The site is designated as a key / general employment area in the Local Plan and it is recommended that the site is protected for employment uses.</p>		

Quarry Lane (Ref: MDC15)



**GROSS SITE AREA:
4.62 ha**

**ESTIMATED NET DEVELOPABLE
AREA:
0 ha**

CRITERIA	COMMENT	RATING
<p>Site Context</p> <ul style="list-style-type: none"> • Location with regards to existing employment areas and other sites • How the site fits into the overall portfolio 	<p>This is an existing employment site within the Mansfield urban area and to the south of the town centre. It is approximately 500m north of the Hamilton Way industrial area.</p>	
<p>Local Plan Designation</p>	<p>The Development Plan for Mansfield comprises of the Mansfield District Local Plan 2013-2033 (Adopted September 2020). The site is designated as a Key / General Employment Area (Policy E3u).</p>	
<p>Status in SHLAA</p>	<p>N/A</p>	
<p>Planning History</p>	<p>2019/0153/FUL - Extensions and alterations to existing workshop including provision for additional staff welfare facilities and additional car parking – Granted with conditions 20.06.0219</p>	
<p>Current Use and Land Type</p>	<p>This is a brownfield site occupied by employment uses.</p>	
<p>Occupier Profile (if partly developed, including % of available land and levels of vacancy onsite)</p>	<p>This site is fully developed and primarily occupied by SDC Trailers (trailer manufacturer). There are a number of smaller workshops off Highfield Way and Broader Way accommodating a range of construction, engineering, manufacturing and vehicle servicing uses. All the units appeared to be occupied at the time of the site visit (November 2020).</p>	
<p>Strategic Road Access</p>	<p>The site is approximately 500m from the A60 and 1km from the A38. It is approximately 10.3km</p>	<p>Poor</p>

	from junction 28 of the M1 via the A617 and A38.	
Local Road Access	The site is accessed via Quarry Lane. Quarry Lane is easily accessible from the North East end via the A60, however, access from the South West end via Sheepbridge Lane is constricted by a restricted-height railway bridge (max height 4.8m and only passable by one vehicle at a time) which passes over the road to the South of the site. When approaching Quarry Lane via the A38, access is again constrained by another restricted-height railway bridge (max height 3.3m) on Sheepbridge Lane approximately 06.km from the site.	Poor
Proximity to Urban Areas and Access to Labour and Services (including public transport / cycling / walking accessibility)	The site is located towards the South West outskirts of Mansfield centre which is 2km from the site via the A60. Mansfield provides a wide range of facilities and services including schools, medical services, shops, a range of recreational facilities and a police station. The Site is not serviced by regular public transport services; the closest regular bus services are accessed via stops on the A60 which is 0.5 km from the site. Buses from the A60 travel North towards Mansfield and South towards Nottingham, Berry Hill and Forest Town. Mansfield railway station is approximately 1km away and is serviced by regular buses from the A60.	Average
Compatibility of Adjoining Uses (including amenity impacts experienced by current/future occupiers and neighbouring areas)	The site is bordered by Mansfield Town Football Club and Portland Retail Park to the East, the East Midlands Railway to the North, Quarry Lane with the River Maun and Quarry Lane Nature Reserve beyond to the South and the railway line and Moor Lane Park/allotment land to the West.	Good
Developmental and Environmental Constraints (e.g. size; topography; site access; roads, lighting, landscaping, mains utilities and communications infrastructure; flood risk; contamination; nature and heritage conservation)	This is a small employment site with existing utilities and communications infrastructure. The site slopes up to the north and is bound by the railway line to the north and west and the River Maun with the Quarry Lane Nature Reserve beyond to the south. Drury Dam Viaduct immediately south of the site is grade II listed (ref. 1207187). The site is within Flood Zone 1 and therefore at low risk of flooding.	Average
Barriers to Delivery and Mitigation	The site is fully developed and no other barriers to redevelopment were evident from the site visit.	Good

(including ownership constraints - if known)		
Market Attractiveness (including appropriateness, vacancy and market activity on site for the type of development proposed)	This is a small site in a good central location within the main urban area of Mansfield. It is occupied by a range of employment uses and has low vacancy levels but is in need of some repair and maintenance to improve its kerb appeal.	Average
Strategic Fit with Growth Area Objectives (by target Market Segment)	This site already accommodates key industrial growth sectors as identified in the D2N2 Vision 2030 document including transport equipment manufacturing.	Average
OVERALL SITE RATING	Average	
Recommendation and Potential Future Uses	Protect for employment uses (i.e. retain allocation as a key / general employment area)	
SITE SUMMARY:		
<p>This is an existing employment site within the Mansfield urban area, to the south of the town centre and approximately 500m north of the Hamilton Way industrial area. It is primarily occupied by a trailer manufacturer and a number of smaller workshop units. This is a small site in a good central location with low vacancy levels but is in need of some repair and maintenance. The site is designated as a key / general employment area in the Local Plan and it is recommended that the site is protected for employment uses.</p>		

Penniment Farm (Ref: MDC16)



GROSS SITE AREA:
12.72 ha

ESTIMATED NET DEVELOPABLE AREA:
9 ha

(Note: The allocation is for a minimum of 9ha)

CRITERIA	COMMENT	RATING
<p>Site Context</p> <ul style="list-style-type: none"> • Location with regards to existing employment areas and other sites • How the site fits into the overall portfolio 	<p>This is a greenfield site to the west of Mansfield. It is part of a wider development (permission ref. 2010/0805/ST) for up to 430 homes, 39,216 sqm employment space and 84sqm of retail space. The first phase is being delivered by Persimmon to the south of Water Lane.</p>	
<p>Local Plan Designation</p>	<p>The Development Plan for Mansfield comprises of the Mansfield District Local Plan 2013-2033 (Adopted September 2020). The site is allocated for Employment (E2c). Policy E2c Penniment Farm allocates the site for a minimum of 9 hectares of employment uses and with direct access from the Mansfield and Ashfield Regeneration Route (MARR).</p> <p>The wider site to the north is allocated for Housing (H2).</p>	
<p>Status in SHLAA</p>	<p>The HELAA (2017) identified the site (ref. 82) as a 'reasonable alternative' consented site.</p>	
<p>Planning History</p>	<p>Recent planning applications include:</p> <ul style="list-style-type: none"> • 2010/0805/ST - Outline planning application (including the reserved matter of access) for mixed use development comprising housing (maximum 430 units) & employment (use classes b1, b2 and b8 - up to 39,216 sqm) retail (use class a1 - up to 84 sqm), open space, landscaping, access and infrastructure works – Granted with conditions 12.12.2012 This includes the appraisal site and land to the north. • 2017/0572/RES - Approval of reserved matters for the erection of 202 no. Residential (c3) dwellings including details for the layout, appearance, scale and landscaping 	

	<p>on outline planning application - 2010/0805/ST (outline application including the reserved matter of access for mixed use development comprising housing (maximum 430 units) and employment (use classes b1, b2 and b8 - up to 39,216 sqm) retail (class a1) up to 84 sqm, open space, landscaping, access and infrastructure works. – Granted with conditions 12.02.2018 This is Phase 1 of the wider development and is being brought forward by Persimmon. It is located in the north-eastern corner of the wider site.</p> <ul style="list-style-type: none"> • 2015/0502/ST - Application for the approval of the reserved matters of access, appearance, landscaping, layout and scale of phase 1 junction works to water lane following outline planning permission for mixed use development comprising housing (maximum 430 units) & employment (use classes b1, b2 and b8 - up to 39,216 sq m) retail (use class a1 - up to 84 sq m) (2010/0805/ST) – Grant approval 10.12.2015 • 2018/0791/RES - Approval of reserved matters on planning permission 2010/0805/ST (outline planning application (including the reserved matter of access) for mixed use development comprising housing (maximum 430 units) & employment (use classes b1, b2 and b8 - up to 39,216 sq m) retail (use class a1 - up to 84 sq m), open space, landscaping, access and infrastructure works) for appearance, landscaping, layout and scale for 220 residential dwellings only – Pending – Validated 10.12.2018 • 2018/0790/RES - Approval of reserved matters application for appearance, landscaping, layout and scale for the spine road on outline application 2010/0805/ST – Pending – Validated 10.12.2018 • There has also been non-material amendment, discharge of conditions and diversion of footpath applications in relation to development of the wider site. 	
Current Use and Land Type	This is a greenfield site in agricultural use.	
Occupier Profile (if partly developed, including % of available land and levels of vacancy onsite)	N/A – this is a vacant greenfield site.	
Strategic Road Access	The site is adjacent to the A617 but is 10 km from junction 29 of the M1 via the A617.	Average
Local Road Access	The site is bordered by the A617 to the West and North and the A6075 to the South and East. Both are good, free-flowing roads with the A617 continuing North onto the M1 and the A60785 continuing East to the town of Mansfield Woodhouse. There is a gate and track access to the site from the A617 to the north.	Good

<p>Proximity to Urban Areas and Access to Labour and Services (including public transport / cycling / walking accessibility)</p>	<p>The site is located on the western periphery of Mansfield, to the North East of Skegby and to the North of Sutton-in-Ashfield via the A6075. Mansfield town centre (approximately 3.8km from the site) provides a wide range of facilities and services including schools, medical services, shops, recreational facilities, police station and railway station. Infrequent bus services from the A6075 adjoining the site service Mansfield town centre and railway station, Bull Farm, Ladybrook and Kirkby in Ashfield.</p>	<p>Average</p>
<p>Compatibility of Adjoining Uses (including amenity impacts experienced by current/future occupiers and neighbouring areas)</p>	<p>The site is bordered by the A617 to the West and North with greenfield land beyond. The A6075 borders the site to the South and East with residential areas and greenfield land beyond. There are a couple of covered reservoirs adjacent to the site to the South-West.</p>	<p>Average</p>
<p>Developmental and Environmental Constraints (e.g. size; topography; site access; roads, lighting, landscaping, mains utilities and communications infrastructure; flood risk; contamination; nature and heritage conservation)</p>	<p>This is a relatively level greenfield site with a gated track access from the A617. Hedgerows intersect and demarcate the site. A footpath also intersects the site from east to west. The site is within Flood Zone 1 and therefore at a relatively low risk of flooding.</p> <p>There are two listed buildings within 400m north-west of the site: Penniment Lodge Farm (ref. 1096124) and Barn at Penniment Lodge Farm (ref. 1096123).</p>	<p>Good</p>
<p>Barriers to Delivery and Mitigation (including ownership constraints - if known)</p>	<p>The infrastructure requirements have been considered as part of the planning applications. No other barriers to delivery were evident from the site visit.</p>	<p>Very Good</p>
<p>Market Attractiveness (including appropriateness, vacancy and market activity on site for the type of development proposed)</p>	<p>This is a highly visible site on the outskirts of Mansfield with a new access from the MARR proposed. The site is likely to be attractive to a variety of employment uses.</p>	<p>Good</p>
<p>Strategic Fit with Growth Area Objectives (by target Market Segment)</p>	<p>This site has potential to accommodate key industrial growth sectors as identified in the D2N2 Vision 2030 document.</p>	<p>Good</p>
<p>OVERALL SITE RATING</p>	<p>Good</p>	
<p>Recommendation and Potential Future Uses</p>	<p>Allocate for employment uses (i.e. retain allocation for employment uses)</p>	
<p>SITE SUMMARY:</p>		
<p>This is a greenfield site to west of Mansfield. The site is allocated for employment uses - a</p>		

minimum of 9 ha and with direct access from the Mansfield and Ashfield Regeneration Route (MARR). Land to the north is allocated for housing. The site is within the wider site, including land to the north, granted outline permission for up to 430 homes, 39,216 sqm employment space and 84sqm of retail space. The first phase, to the south of Water Lane, is being delivered by Persimmon. It is recommended that the that the site is allocated for employment uses.

Newark Industrial Estate (NUA/E/1) (Ref: NSDC1)



**GROSS SITE AREA:
96.08 ha**

**ESTIMATED NET DEVELOPABLE AREA:
23.56 ha**
(Note: Comprising of Land off Beacon Hill Road (NSDC3) 16ha and Land west of the A1 on Stephenson Way (NUA/E/2) (NSDC22) 7.56ha)

CRITERIA	COMMENT	RATING
<p>Site Context</p> <ul style="list-style-type: none"> • Location with regards to existing employment areas and other sites • How the site fits into the overall portfolio 	<p>This site comprises of the well-established and popular Newark Industrial Estate which is situated on the north-eastern side of Newark-upon-Trent. There are areas of undeveloped greenfield land within the north and east of the site offering potential expansion space for employment uses.</p> <p>This site includes other smaller sites assessed within this study: Land off Beacon Hill (greenfield land to the east) and NUA/E/2 Land West of the A1 on Stephenson Way (greenfield land to the north-east). The site is also within close proximity of the Dixons Mastercare site (on the eastern side of the A1) and the mixed-use allocation NUA/MU/1 North of the A17.</p>	
<p>Local Plan Designation</p>	<p>The Development Plan for the District comprises of the Amended Core Strategy (adopted 7th March 2019) and Allocations & Development Management (adopted 16 July 2013) Development Plan Documents. The site is within the NUA/E/1 – Newark Urban Area – Newark Industrial Estate Policy Area (Allocations & Development Management DPD, 2013).</p> <p>Other sites within this site include NUA/E/2 and NUA/E/3 (Newark Urban Area – Newark Industrial Estate Policy Area) (Allocations & Development Management DPD, 2013).</p> <p>To the north of the site is an area of land designated as a mixed-use allocation (non-residential) (NUA/MU/2,</p>	

	<p>Allocations & Development Management DPD, 2013); to the west, land used for Public Open Space/School Playing Fields (Policy SP8, Amended Core Strategy, 2019); and to the south of the site a second mixed-use allocation (NUA/MU/3, Allocations & Development Management DPD, 2013) and a Site of Interest in Nature Conservation (Core Policy 12 and DM7).</p> <p>To the west is NUA/Ho/4 which is a significant regeneration scheme (this site includes significant public open space which abuts the Industrial estate). The site is contained within the Urban Boundary of Newark Urban Area as defined in Policy DM1 of the Allocations & Development Management DPD.</p> <p>The site is contained within the urban boundary/village envelope (DM1) as defined in the Newark & Sherwood LDF Policies Map.</p>
Status in SHLAA	Site Ref: Land East of Northern Road (08_0651) for a proposed yield of 29 dwellings. The site could be available in 10-15 years.
Planning History	<p>Recent planning history includes;</p> <ul style="list-style-type: none"> • 19/01631/FUL - Vehicle fuelling facility - 0.58ha/5,769 sqm • 18/00018/FULM - 23 industrial units - 1.10ha/10,991 sqm – this permission is being implemented. • 14/01376/FUL - CU to vehicle hire - 0.16ha/1,558 sqm • 18/00708/FUL - Containerised self-storage - 0.48ha/4,757 sqm • 18/01122/FUL - Motor vehicle storage - 0.86ha/8,576 sqm • 10/01349/FUL - Proposed new secure vehicle parking depot -0.58ha/5,825 sqm • 20/00309/FULM - Erection of proposed builders merchant -0.81ha/8,056 sqm • 16/SCR/00001 - Request for screening opinion for Industrial development - Environmental Impact Assessment Required – 18.04.2016. This relates to the undeveloped greenfield site to the east ‘Land off Beacon Hill Road’
Current Use and Land Type	This is primarily a brownfield site occupied by an industrial estate, with areas of undeveloped greenfield land to the east.
Occupier Profile (if partly developed, including % of available land and levels of vacancy onsite)	<p>This is a large industrial estate occupied by a range of employment uses, occupiers include:</p> <ul style="list-style-type: none"> • Food manufacturing - Bakkavor Desserts, Goodlife Foods and Daloon Foods. Kevin Hancock Chilled Food (cold storage facility). • Vodafone call centre • Timico (Software company) • Vehicle sales, MOT and service centres.

	<ul style="list-style-type: none"> • Building and DIY stores including Howdens, Screwfix and Travis Perkins. • Logistics providers – Buffalo • Healthcare and medical equipment suppliers including St Johns Ambulance First Aid Training Centre and Hillside Medical Supplies • Everyday Champions (Conference centre) and Flexspace (business centre) • Household Waste and Recycling Centre • NCP Car Park • Newark & Sherwood District Council Brunel Drive Depot • Sports Direct Gym <p>There are undeveloped sites within the wider site as follows:</p> <ul style="list-style-type: none"> • Land off Beacon Hill Road is an undeveloped greenfield site comprising of 16 ha net developable area and is currently on the market for build-to-suit logistics/warehouse up to 70,978 sqm. • In relation to the NUA/E/2 Land west of the A1 on Stephenson Way (within the north east of this site) there is 7.56 ha net developable area as follows: The northern area has been partially developed: Compound 1 (18/00708/FUL) 0.48ha of containerised self-storage occupied by Loc-Box; and Compound 2 (18/01122/FUL) 0.86ha of motor vehicle storage associated with Brownhills Motorhomes adjacent. The southern area is vacant greenfield land and the land between the two areas outlined in red has been developed for a Moy Park hatchery (agricultural use) (ref. 16/00166/FULM). <p>The following units were vacant at the time of the site visit (December 2020):</p> <ul style="list-style-type: none"> • Unit 8 Glenholm Park, Brunel Drive – modern industrial trade counter/warehouse of 195 sqm • Unit 5 Newark Business Park – industrial workshop of 625.6 sqm • Units 21 and 22 Newark Business Park – modern light industrial units of 202 sqm and 313.75 sqm • Unit A4 Enterprise Park – modern trade counter/warehouse of 173 sqm • Unit 3-4 Newark Business Park – warehouse and ancillary offices of 1804 sqm • Northern Road – fenced compound – 1705 sqm • Flexspace – office space 37 – 186 sqm • Jessop Park, Jessop Close (the units being developed under permission ref. 18/00018/FULM) Block 1 was available in September 2020 and Block 2 was due to commence in 2021. Units between 93 sqm – 652 sqm. 		
Strategic Road Access	<table border="1" style="width: 100%;"> <tr> <td style="width: 80%;">The site is adjacent to the A1 and can be accessed via Lincoln Road within 1km.</td> <td style="width: 20%;">Good / Very</td> </tr> </table>	The site is adjacent to the A1 and can be accessed via Lincoln Road within 1km.	Good / Very
The site is adjacent to the A1 and can be accessed via Lincoln Road within 1km.	Good / Very		

		Good
Local Road Access	The site can be accessed at two points along Lincoln Road - to the North (onto Brunel Drive) and West (onto Northern Road), and from The South via Beacon Hill Road (onto Northern Road). Both Lincoln Road and Beacon Hill Road travel through residential areas in places. Due to congestion, accessing and exiting the site at peak times can be problematic.	Good
Proximity to Urban Areas and Access to Labour and Services (including public transport / cycling / walking accessibility)	The site is situated to the North East of the residential town of Newark-upon-Trent. Newark provides a wide range of services and amenities including a hospital, schools, a shopping centre, retail park, restaurants and various recreational facilities. Newark Northgate railway station provides regular train services towards Nottingham, Lincoln and London – the station is less than 0.5km from the site to the South West but is not directly accessible by foot or public transport. Buses from Lincoln Road provide regular services into Newark centre. Buses from Beacon Hill Road provide regular services to Coddington and Newark centre. National Cycle Route 64 runs alongside the site beyond the railway line to the South West, however, there is no direct access to this from the site.	Good / Very Good
Compatibility of Adjoining Uses (including amenity impacts experienced by current/future occupiers and neighbouring areas)	The site is bordered by residential areas to the North West and South, by greenfield land to the East and further industrial/retail units with the East Midlands Railway line beyond to the South West/West.	Average
Developmental and Environmental Constraints (e.g. size; topography; site access; roads, lighting, landscaping, mains utilities and communications infrastructure; flood risk; contamination; nature and heritage conservation)	This is a large relatively level site occupied by an established industrial estate with existing utilities and communications infrastructure. A review of Flood Maps for Planning (Gov.uk, 2021) shows the site is not located within a flood zone. There is a drainage ditch onsite. The site is not subject to any listed buildings nor are there any within the immediate vicinity (Historic England Listing Map, 2021). Slough Dyke, with possible hazardous landfill gases within the site. Beacon Hill Conservation Park is immediately to the east of the site.	Average

<p>Barriers to Delivery and Mitigation (including ownership constraints - if known)</p>	<p>The Bridge Ward Neighbourhood Study identified key concerns with traffic flow and parking within the NUA/E/1 Policy Area. The District Council will work with the County Council, the owners and businesses located within the Policy Area to resolve existing traffic issues and seek to secure additional connectivity to the wider Bridge Ward including Newark Northgate Station (Allocations & Development Management DPD, 2013).</p> <p>Slough Dyke, possible hazardous landfill gases within the site. No other barriers to delivery were evident from the site visit.</p>	<p>Average</p>
<p>Market Attractiveness (including appropriateness, vacancy and market activity on site for the type of development proposed)</p>	<p>This site has good strategic road access and visibility from the adjoining A1. It is a well-established and popular industrial estate on the edge of Newark and would be an attractive location for a range of occupiers.</p>	<p>Good</p>
<p>Strategic Fit with Growth Area Objectives (by target Market Segment)</p>	<p>This site already accommodates key industrial growth sectors as identified in the D2N2 Vision 2030 document including Food & Drink Manufacturing, Transport Equipment Manufacturing, Creative & Digital, Logistics & E-Commerce, Construction, Retail, Health/Social Care and Professional/Business Services. The site has the potential to accommodate further businesses within key growth sectors, particularly logistics.</p>	<p>Very Good</p>
<p>OVERALL SITE RATING</p>	<p>Good</p>	
<p>Recommendation and Potential Future Uses</p>	<p>Allocate for employment uses (i.e. retain Newark Industrial Estate Policy Area)</p>	
<p>SITE SUMMARY:</p>		
<p>This site comprises of the well-established and popular Newark Industrial Estate which is situated on the north-eastern side of Newark-upon-Trent. This site includes other smaller sites assessed within this study: Land off Beacon Hill (greenfield land to the east) and NUA/E/2 Land West of the A1 on Stephenson Way (greenfield land to the north-east).</p> <p>This is a large industrial estate occupied by a range of uses including Food & Drink Manufacturing, Logistics & E-Commerce, Professional/Business Services and Health/Social Care. Key occupiers include a Vodafone Call Centre and Bakkavor Desserts. Non-employment uses include a Household Waste and Recycling Centre, NCP Car Park, Newark & Sherwood District Council Brunel Drive Depot and Sports Direct Gym. There was a low level of vacant units at the time of the site visit. There are undeveloped greenfield sites within the wider site including land off Beacon Hill Road (within the east of the site) comprising of 16 ha net-developable area and land west of the A1 on Stephenson Way (within the north east of this site) comprising of 7.56 ha net-developable area.</p>		
<p>The site is within the NUA/E/1 – Newark Urban Area – Newark Industrial Estate Policy Area and</p>		

it is recommended that it is allocated for employment uses.

Dixons Mastercare Site (Ref: NSDC2)



**GROSS SITE AREA:
39.71 ha**

**ESTIMATED NET DEVELOPABLE AREA:
4.45 ha**

CRITERIA	COMMENT	RATING
<p>Site Context</p> <ul style="list-style-type: none"> • Location with regards to existing employment areas and other sites • How the site fits into the overall portfolio 	<p>This is a key employment site occupied by Dixons Mastercare with excellent strategic road access.</p> <p>The site is within close proximity of the Brunel Drive industrial area to the west of the A1 and a site allocated for mixed-use (NUA/MU/1) to the north of the A17 which is now being delivered, Wirtgen Group machinery manufacturer occupy the eastern portion.</p>	
<p>Local Plan Designation</p>	<p>The Development Plan for the District comprises of the Amended Core Strategy (adopted 7th March 2019) and Allocations & Development Management (adopted 16 July 2019) Development Plan Documents.</p> <p>The Newark & Sherwood Local Development Framework Policies Map shows the site is not allocated, a small allocation for employment use (with planning permission, April 2011) is however designated on undeveloped land to the north of the site bordering the road network.</p> <p>Beyond the A1 to the west is an additional employment site (NUA/E/2 – Newark Urban Area – Employment Site 2, Allocations & Development Management DPD, 2013) and a mixed-use allocation (non-residential) (NUA/MU/2 – Newark Urban Area – Mixed Use Site 2, Allocations & Development Management DPD, 2013). A second mixed-use allocation (NUA/MU/1 – Newark Urban Area – Mixed Use Site 1, Allocations & Development Management DPD, 2013) is located across the A17 to the north-east.</p>	

	The site is also contained within the urban boundary/village envelope (DM1) as defined in the Newark & Sherwood Local Development Framework Policies Map.	
Status in SHLAA	N/A	
Planning History	Recent planning history includes: 16/01505/FULM - New warehouse - 617.5m ² – Granted 07.12.2016. This relates to the Dixons Carphone Warehouse. 08/00235/OUTM - Outline application for multi-let office development and storage/distribution building – Site area 4.45ha – Granted 11.11.2010. This relates to the vacant land within the northern area of the site.	
Current Use and Land Type	This is a brownfield site occupied by logistics warehousing.	
Occupier Profile (if partly developed, including % of available land and levels of vacancy onsite)	The site is occupied by Dixons Mastercare, Currys PC World, Carphone Warehouse Distribution Centre, Team Knowhow and Ford & Slater Truck Dealers. The buildings are modern and the quality of the environment is good. There is an undeveloped area of land within the site adjacent to the access road from the A17. It comprises of 4.45ha and has historical planning permission for office and warehouse development.	
Strategic Road Access	The site adjoins the A17 and A46 to the North and the A1 to the West.	Very Good
Local Road Access	The site can be directly accessed from both the A1 (Northbound and Southbound) and the A46 (Eastbound and Westbound) via a junction with the A17. The site can also be accessed via Lincoln Road which is the main road through the centre of the town of Newark-upon-Trent. All are good, free-moving roads however, Lincoln Road is residential in places.	Very Good
Proximity to Urban Areas and Access to Labour and Services (including public transport / cycling / walking accessibility)	The site is situated on the North Eastern outskirts of the residential town of Newark-upon-Trent. Newark provides a wide range of services and amenities including a hospital, schools, a shopping centre, retail park, restaurants and various recreational facilities. Newark Northgate railway station provides regular train services towards Nottingham, Lincoln and London – the station is 2.7km from the site to the South West but is not directly accessible by public transport. There are cycle paths onsite.	
Compatibility of Adjoining Uses	The site is bordered by the A17 to the North, the	Very Good

(including amenity impacts experienced by current/future occupiers and neighbouring areas)	A1 to the West/South West and greenfield land to the South and East.	
Developmental and Environmental Constraints (e.g. size; topography; site access; roads, lighting, landscaping, mains utilities and communications infrastructure; flood risk; contamination; nature and heritage conservation)	<p>This is a large relatively level site with existing utilities and communications infrastructure in place. A landscaping buffer forms the western site boundary with A1.</p> <p>A review of Flood Maps for Planning (Gov.uk, 2021) shows the site is not located within a flood zone.</p> <p>However, there may be some surface water drainage issues.</p> <p>The site is not subject to any listed buildings nor are there any within the immediate vicinity (Historic England Listing Map, 2021).</p>	Very Good
Barriers to Delivery and Mitigation (including ownership constraints - if known)	There is a landscape buffer adjacent to the A1 and potential surface water drainage issues. No other barriers to development were evident at the site visit.	Very Good
Market Attractiveness (including appropriateness, vacancy and market activity on site for the type of development proposed)	<p>This site has very good strategic road access and significant visibility from adjoining highways. The site is occupied by high-profile businesses and is within close proximity of Newark.</p> <p>There is an undeveloped area of land within the site adjacent to the access road from the A17. It comprises of 4.45 ha and has historical planning permission for office and warehouse development.</p>	Very Good
Strategic Fit with Growth Area Objectives (by target Market Segment)	This site already accommodates key industrial growth sectors as identified in the D2N2 Vision 2030 document including professional/business services, logistics & E-commerce and transport equipment manufacturing. The site has potential to accommodate other key industrial growth sectors on the undeveloped site to the north.	Very Good
OVERALL SITE RATING	Very Good	
Recommendation and Potential Future Uses	Allocate for employment uses.	
SITE SUMMARY:		
<p>This is a key employment site occupied by Dixons Mastercare and Team Knowhow with excellent strategic road access. The site is within close proximity of the Brunel Drive industrial area to the west of the A1 and a site allocated for mixed-use (NUA/MU/1) to the north of the A17 which is now being delivered.</p> <p>The Newark & Sherwood Local Development Framework Policies Map shows the site is not allocated,</p>		

a small allocation for employment use (with planning permission, April 2011) is however designated on undeveloped land to the north of the site bordering the road network. This site comprises of 4.45 ha and has historical planning permission for office and warehouse development. It is recommended that the undeveloped land is allocated for employment uses, with the built-up area of the Mastercare site protected for employment uses.

Land off Beacon Hill Road (G Park) (Ref: NSDC3)



**GROSS SITE AREA:
17.78 ha**

**ESTIMATED NET DEVELOPABLE AREA:
16 ha**
(Note: based on a 90% gross to net ratio)

CRITERIA	COMMENT	RATING
<p>Site Context</p> <ul style="list-style-type: none"> • Location with regards to existing employment areas and other sites • How the site fits into the overall portfolio 	<p>This greenfield site provides natural expansion space for the adjacent Newark industrial estate. It is immediately to the south of the A1 and west of the Dixons Mastercare site.</p>	
<p>Local Plan Designation</p>	<p>The Development Plan for the District comprises of the Amended Core Strategy (adopted 7th March 2019) and Allocations & Development Management (adopted 16 July 2013) Development Plan Documents.</p> <p>The Newark & Sherwood Local Development Framework Policies Map shows the site as an employment site (with planning permission, April 2011).</p> <p>Land off Beacon Hill is also contained within the Newark Industrial Estate Policy Area (NUA/E/1, Allocations & Development Management DPD, 2013).</p> <p>The site also borders a second employment site to the north-east (NUA/E/2 – Newark Urban Area – Employment Site 2, Allocations & Development Management DPD, 2013) and is located adjacent a Site of Interest in Nature Conservation so the south-west (Core Policy 12 and DM7).</p>	
<p>Status in SHLAA</p>	<p>N/A</p>	
<p>Planning History</p>	<p>16/SCR/00001 - Request for screening opinion for Industrial development - Environmental Impact Assessment Required – 18.04.2016</p>	

Current Use and Land Type	This is an undeveloped greenfield site.	
Occupier Profile (if partly developed, including % of available land and levels of vacancy onsite)	This is an undeveloped greenfield site currently on the market for build-to-suit logistics/warehouse up to 70,978 sqm.	
Strategic Road Access	The A1 travels past the North Eastern corner of the site and shares a junction with the A46 approximately 1km from the site.	Good
Local Road Access	The site is currently undeveloped and there is no direct access onto the site by road. Access to the site could be created from Jessop Way to the south. There is a farm track access in the northern corner of the site with an underpass under the A1 to the agricultural land to the east. The A1 and A46 are good, free-moving roads which also share a junction with Lincoln Road approximately 1km from the site. Lincoln Road is the main road through the centre of the town of Newark-upon-Trent and is residential in places. Due to congestion, accessing and exiting the site at peak times can be problematic.	Good
Proximity to Urban Areas and Access to Labour and Services (including public transport / cycling / walking accessibility)	The site is situated on the North Eastern outskirts of the residential town of Newark-upon-Trent. Newark provides a wide range of services and amenities including a hospital, schools, a shopping centre, retail park, restaurants and various recreational facilities. Newark Northgate railway station provides regular train services towards Nottingham, Lincoln and London – the station is 2km from the site to the South West but is not currently accessible by road or public transport.	Good
Compatibility of Adjoining Uses (including amenity impacts experienced by current/future occupiers and neighbouring areas)	The site is bordered to the North, South and East by greenfield land with the A1 passing the top North-Eastern corner. Industrial/retail units border the site to the West.	Very Good
Developmental and Environmental Constraints (e.g. size; topography; site access; roads, lighting, landscaping, mains utilities and communications infrastructure; flood risk; contamination; nature and heritage conservation)	This is a greenfield site adjacent to the Newark Industrial Estate. A review of Flood Maps for Planning (Gov.uk, 2021) shows the site is not located within a flood zone. A drainage channel is located to the west of the site. The site is not subject to any listed buildings nor are there any within the immediate vicinity	Average

	(Historic England Listing Map, 2021). However, the site is close to area where significant archaeological items from Civil War could be found. Slough Dyke, possible hazardous landfill gases within the site.	
Barriers to Delivery and Mitigation (including ownership constraints - if known)	Works to the Jessop Way access road may be required and impact upon traffic on Lincoln Road/Brunel Drive assessed and mitigated. Slough Dyke, possible hazardous landfill gases within the site. No other barriers to delivery were evident from the site visit.	Average
Market Attractiveness (including appropriateness, vacancy and market activity on site for the type of development proposed)	This site has good strategic road access and visibility from the adjoining A1. The site is within the wider Newark Industrial Estate on the outskirts of Newark. It would be an attractive location for logistics operators.	Good
Strategic Fit with Growth Area Objectives (by target Market Segment)	This site has potential to accommodate key industrial growth sectors as identified in the D2N2 Vision 2030 document particularly logistics.	Good
OVERALL SITE RATING	Good	
Recommendation and Potential Future Uses	Allocate for employment uses	
SITE SUMMARY:		
This greenfield site provides natural expansion space for the adjacent Newark industrial estate. It is immediately south of the A1 and west of the Dixons Mastercare site. It has been subject to an EIA screening opinion for Industrial development and is on the market as a development opportunity for a logistics/warehouse of up to 70,978 sqm. It is recommended that this site should be allocated for employment uses.		

British Sugar Corporation, Great North Road (Ref: NSDC4)



**GROSS SITE AREA:
85.10 ha**

**ESTIMATED NET DEVELOPABLE AREA:
5 ha**
(Note: Comprising of land in the south adjacent to Great North Road).

CRITERIA	COMMENT	RATING
<p>Site Context</p> <ul style="list-style-type: none"> • Location with regards to existing employment areas and other sites • How the site fits into the overall portfolio 	<p>This site accommodates the British Sugar manufacturing plant. The site is located on the northern periphery of Newark-on-Trent and approximately 2.5km west of the Brunel Drive Industrial Estate.</p>	
<p>Local Plan Designation</p>	<p>The Development Plan for the District comprises of the Amended Core Strategy (adopted 7th March 2019) and Allocations & Development Management (adopted 16 July 2013) Development Plan Document.</p> <p>The site is undesignated within the LDF.</p> <p>The site is outside the urban boundary/village envelope (DM1), as defined in the Newark & Sherwood Local Development Framework Policies Map.</p> <p>The centre of the site is subject to a hazardous installations designation (DM10, Allocations & Development Management DPD, 2013), with Scheduled Ancient Monuments (Core Policy 14 and DM9) located to the west of the lake in the southern area of the site and also within the east of the site.</p> <p>The south-western corner and northern corridor of the site is designated as a Site of Interest in Nature Conservation (Core Policy 12 and DM7, October 2013).</p>	
<p>Status in SHLAA</p>	<p>N/A</p>	

<p>Planning History</p>	<p>Recent planning history includes: 18/01148/FULR3N - Development is for a change of use from Agricultural land to allow land to be used for conditioning (drying by windrowing) of Topsoil material recovered from sugar beet delivered and excavated from soil settlement lagoons onsite, and engineering works to construct flood compensatory area 17/00587/FUL - Install a sand separation plant and construction of an additional soil storage shed. 16/SCR/00002 - Combined heat and power plant 16/SCR/00003 – Screening request for combined heat and power plant 09/01413/FUL - Erection of 2no portal frame buildings for storage of topsoil - 540m2</p>	
<p>Current Use and Land Type</p>	<p>This is a primarily brownfield site occupied by food manufacturing and topsoil processing premises.</p>	
<p>Occupier Profile (if partly developed, including % of available land and levels of vacancy onsite)</p>	<p>This site accommodates the British Sugar manufacturing plant. British Sugar Topsoil also occupy the site and are a subsidiary of British Sugar plc. The majority of the site is occupied by industrial buildings and car parking, as well as the settlements ponds, land used for topsoil conditioning and topsoil storage.</p> <p>At the time of the site visit the land in the southern portion of the site adjacent to the Great North Road (A616) was undeveloped grassland and potentially suitable for redevelopment.</p>	
<p>Strategic Road Access</p>	<p>Junctions with the A46 and A617 are approximately 0.6km from the site via the A616 (Great North Road). The A1 is approximately 4 km from the site and is accessible via the A46.</p>	<p>Good</p>
<p>Local Road Access</p>	<p>The site is accessed via two points off Great North Road (A616) to the West. The A1, A46, A616 and A617 are all good, free-moving roads. The A616 becomes the B6326 after the junction with the A46 and A617 (approx. 0.6km from the site) and continues towards the town of Newark-upon-Trent.</p>	<p>Very Good</p>
<p>Proximity to Urban Areas and Access to Labour and Services (including public transport / cycling / walking accessibility)</p>	<p>The residential town of Newark-upon-Trent is approximately 1.2km from the site and provides a wide range of services and amenities including a hospital, schools, a shopping centre, retail park, restaurants and various recreational facilities.</p> <p>Newark Castle railway station is approximately 1km from the site and provides regular train services to Lincoln and Nottingham. Buses from the A616 adjacent to the site provide</p>	

	<p>regular services into Newark centre and Newark Castle train station Southbound and Retford Northbound.</p> <p>Newark Northgate railway station provides regular train services towards Nottingham, Lincoln and London – the station is less than 3km from the site to the South West but is not directly accessible by public transport.</p>	
<p>Compatibility of Adjoining Uses (including amenity impacts experienced by current/future occupiers and neighbouring areas)</p>	<p>The site is bound by the A616 to the West, the A46 to the South and the East Midlands Railway line and River Trent to the East. Smeatons Lakes Caravan and Fishing Park borders the site to the North.</p>	Average
<p>Developmental and Environmental Constraints (e.g. size; topography; site access; roads, lighting, landscaping, mains utilities and communications infrastructure; flood risk; contamination; nature and heritage conservation)</p>	<p>This is a large, relatively level site with existing infrastructure associated with the British Sugar operations.</p> <p>A review of Flood Maps for Planning (Gov.uk, 2021) shows the majority of the site is located within a Flood Zone 3, with a significant Flood Zone 2 designation towards the north of the site. The main river is located to the west of the site. There are various settlement ponds located on the site associated with the topsoil processing.</p> <p>The site is also subject to a couple of Scheduled Monuments (ref. 1016046) in the south and in the east (ref. 1016152), additional listed structures are located on the sites border with the Great Northern Road (causeway arches, Grade II listed) (Historic England Listing Map, 2021). There are also environmental designations in close proximity to the site.</p> <p>The centre of the site is subject to a hazardous installations designation.</p> <p>Overhead lines run adjacent to the site’s western boundary and cross the southern portion of the site. There is also a telecommunications mast within the centre of the site.</p> <p>The south-western corner and northern corridor of the site is designated as a Site of Interest in Nature Conservation (Core Policy 12 and DM7, October 2013).</p>	Very Poor
<p>Barriers to Delivery and Mitigation (including ownership constraints - if known)</p>	<p>There are probable contamination issues onsite due to its current use. The majority of the site is at medium to high risk of flooding and this risk would need mitigating as part of part of any future redevelopment. Redevelopment of any area</p>	Very Poor

	identified as a site of interest in nature conservation would need to demonstrate the need for development outweighed the nature conservation value, be supported by an ecological assessment and the development designed to avoid significantly harmful ecological impacts alongside appropriate mitigation/compensation.	
Market Attractiveness (including appropriateness, vacancy and market activity on site for the type of development proposed)	This is a large site in an accessible location on the edge of Newark. Areas of the southern portion of the site adjacent to Great North Road may be suitable for redevelopment.	Good
Strategic Fit with Growth Area Objectives (by target Market Segment)	This site already accommodates key industrial growth sectors as identified in the D2N2 Vision 2030 document including food and drink manufacturing. British Sugar is a key employer for the District.	Good
OVERALL SITE RATING	Average	
Recommendation and Potential Future Uses	Allocate for employment uses, protect land occupied by British Sugar for ongoing employment uses.	
SITE SUMMARY:		
<p>This site is occupied by British Sugar food manufacturing and topsoil processing premises, a key employer for the District. The site is located on the northern periphery of Newark-on-Trent and approximately 2.5km west of the Brunel Drive Industrial Estate. It is in an accessible location within close proximity of the A1. Redevelopment of the site is constrained by its location within Flood Zone 3 and the multiple ponds onsite. The site is also subject to a couple of Scheduled Monuments and additional listed structures on the western boundary. The majority of the site is occupied by manufacturing buildings and car parking, as well as the settlements ponds, land used for topsoil conditioning and topsoil storage.</p> <p>At the time of the site visit, the land in the southern portion of the site adjacent to the Great North Road (A616) appeared to be undeveloped grassland and potentially suitable for redevelopment, albeit a portion of this site is designated as a Site of Interest in Nature Conservation in the Local Plan. The wider site is undesignated within the Local Development Framework and it is recommended that it is allocated for employment.</p>		

Bowbridge Road Policy Area (NUA Ho 7) (Ref: NSDC5)



**GROSS SITE AREA:
23.09 ha**

**ESTIMATED NET DEVELOPABLE AREA:
2.48 ha**
(Note: based on undeveloped site allocated for housing ref. NUA/Ho/8 and now subject to a planning application for residential development ref. 20/00580/FULM)

CRITERIA	COMMENT	RATING
<p>Site Context</p> <ul style="list-style-type: none"> • Location with regards to existing employment areas and other sites • How the site fits into the overall portfolio 	<p>This site is primarily occupied by construction and extractive industries as well as a modern industrial development – Balderton Business Park. The site is immediately to the north west of the Flowserve Pump Division site. The site is also to the north of the ‘Middlebeck’ sustainable urban extension comprising of up to 3,150 homes.</p> <p>The first phases are under construction, indeed, Bellway and Avant Homes are bringing forward sites immediately south of the site.</p>	
<p>Local Plan Designation</p>	<p>The Development Plan for the District comprises of the Amended Core Strategy (adopted 7th March 2019) and Allocations & Development Management (adopted 16 July 2013) Development Plan Documents. The site is allocated under policy NUA/Ho/7 (Newark Urban Area – Bowbridge Road Policy Area (see excerpt of the Policies Map below), Allocations & Development Management DPD, 2013), within this area, proposals to redevelop vacant brownfield sites will be encouraged.</p> <p>As set out in the DPD, this area is going through a period of change as long-established industrial uses are disappearing and brownfield sites are becoming vacant. The normal recycling of land however is restricted by continuing neighbouring uses within the Area. Therefore, a policy to facilitate re-use of the sites is proposed to ensure proper redevelopment of the area.</p>	

Figure 1 Newark & Sherwood Policies Map

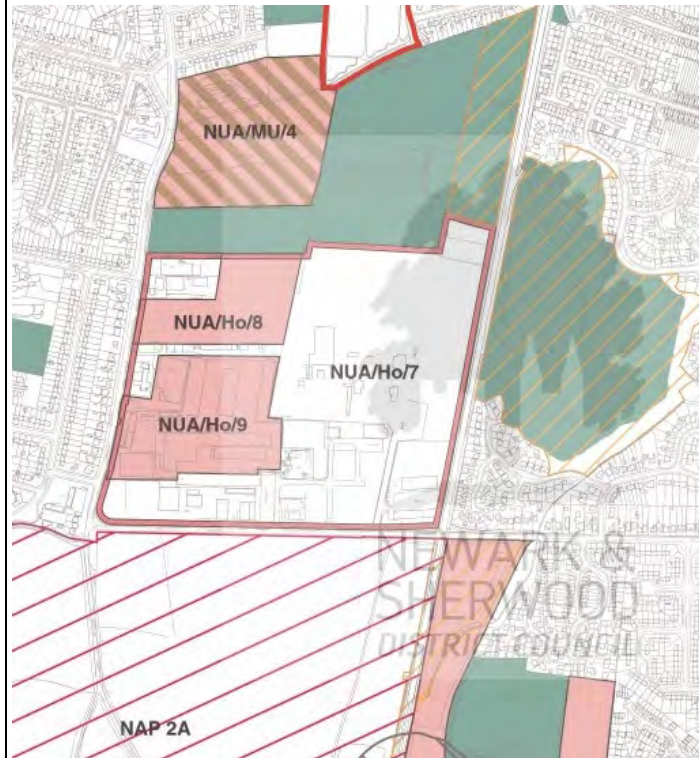

Source: Newark & Sherwood District Council

The north-west corner of the site is allocated as NUA/Ho/8 (Newark Urban Area – Housing Site 8 – c.86 dwellings), this site is currently subject to a planning application for residential development as discussed below. The south-west corner of the site is allocated as NUA/Ho/9 (Newark Urban Area – Housing Site 9 – c. 150 dwellings). This site is currently occupied by employment uses. (Allocations & Development Management DPD, 2013).

Bordering the site to the south is a Strategic Site (Land South of Newark – NAP 2A) with designated Public Open Space/School Playing Fields (Core Strategy, Spatial Policy 8) to the north. The sustainable urban extension comprises of up to 3,150 new homes, a strategic link road between the A1 and A46 and 49 ha of employment, as well as community facilities and open spaces. Outline permission has been granted for the wider development known as ‘Middlebeck’ with reserved matters permission for the first phases, development of these is underway.

To the east of the site is a second site allocated for Public Open Space/School Playing Fields (Spatial Policy 8) this area of land is also designated as a Site of Interest in Nature Conservation (Core Policy 12 and DM7).

<p>Status in SHLAA</p>	<p>Site Ref: Ash Pile off Hawton Lane (08_0543) for a proposed yield of 304 dwellings (40dph). The site could be available in 10-15 years. Site Considered Suitable.</p> <p>Site Ref: Newark Storage, Bowbridge Road (08_0243) for a proposed yield of 128 dwellings (40dph). The site could be available in 5-10 years. Site May be Considered Suitable.</p> <p>Site Ref: East of Bowbridge Road (08_0542) for a proposed yield of 21 dwellings. The site could be available in 10-15 years. Site May be Considered Suitable.</p>	
<p>Planning History</p>	<p>Recent planning history includes: 20/00580/FULM – Erection of 98 dwellings – validated 21.05.2020 – This relates to allocated housing site NUA/Ho/8 and the site area comprises of 2.48ha of vacant land previously used for industrial purposes. 18/02202/FUL - Office attached to existing approved industrial units</p>	
<p>Current Use and Land Type</p>	<p>This is a brownfield site in employment use.</p>	
<p>Occupier Profile (if partly developed, including % of available land and levels of vacancy onsite)</p>	<p>This site is occupied by a range of employment uses primarily in the construction and extractive industries: Tarmac Newark Aggregate Block Plant Hy-Ten – steel reinforcement fabrications and supplier Centrum Pile – piling manufacturer and supplier Farmstar Ltd – agricultural machine parts Jewson - building materials supplier BP Petrol Filling Station (including Greggs bakery) Newark self-storage Reflex Gaming – gaming design and development Richford Motor Services Vehicle Repairs and Dealerships</p> <p>Balderton Business Park is within the site, located between Jewson and Tarmac. It is a modern, high quality, courtyard industrial development. At the time of the site visit (December 2020) there was one unit of 70.5 sqm on the market for sale.</p> <p>Within the site, there is a vacant site of 2.48ha (allocated for housing ref. NUA/Ho/8) previously used for industrial purposes. It is now subject to a planning application for residential development ref. 20/00580/FULM.</p>	
<p>Strategic Road Access</p>	<p>The A1 is approximately 2.5km from the site via Hawton Lane and the B6326 (London Road). Albeit, strategic Road Access will improve as the Southern Link Road is developed.</p>	<p>Poor</p>
<p>Local Road Access</p>	<p>The site is accessed via Hawton Lane to the south</p>	<p>Average</p>

	and Bowbridge Road to the West - both are residential roads. The A1 can be accessed via Hawton Lane and the B6326 (London Road). London Road passes through the residential town of Balderton en-route to the A1.	
Proximity to Urban Areas and Access to Labour and Services (including public transport / cycling / walking accessibility)	<p>The site is situated towards the South Eastern border of the residential town of Newark-upon-Trent and the Western border of the smaller residential town of Balderton/New Balderton. Balderton provides schools, a medical centre and local shops and amenities.</p> <p>Newark on Trent provides a wide range of services and amenities including a hospital, schools, a shopping centre, retail park, restaurants and various recreational facilities.</p> <p>Buses from Bowbridge Road adjacent to the site provide regular services into Newark, Hawtonville and Balderton.</p> <p>Newark Castle railway station is approximately 3.4km from the site and provides regular train services to Lincoln and Nottingham. Newark Northgate railway station is approximately 2.7km from the site and provides regular train services towards Nottingham, Lincoln and London. Neither train station is directly accessible by public transport; however, National Cycle Route 64 along the East of the site continues directly through to Newark Northgate station.</p>	Good / Average
Compatibility of Adjoining Uses (including amenity impacts experienced by current/future occupiers and neighbouring areas)	<p>The site is bordered by Balderton Road to the West, allotment/recreational ground to the North with YMCA Activity Village and the recently developed Gladstone House Retirement Home and Newark Sports and Fitness Centre beyond, Hawton Lane to the South with new residential development beyond and National Cycle Route 64 to the East with residential areas and Balderton Lake beyond.</p> <p>The land to the south of the site is being developed for new residential properties by Bellway and Avant Homes, as part of the wider Middlebeck urban extension.</p>	Poor
Developmental and Environmental Constraints (e.g. size; topography; site access; roads, lighting, landscaping, mains utilities and communications infrastructure; flood risk; contamination; nature and heritage conservation)	<p>This is a large, relatively level site in employment use with utilities and communications infrastructure in place.</p> <p>Disused railway line, now path/cycle route and residential properties to east.</p> <p>A review of Flood Maps for Planning (Gov.uk, 2021) shows the site is not located within a Flood Zone. A Flood Zone 3 however is designated to the</p>	Average

	<p>east of the site.</p> <p>The site is not subject to any listed structures nor are there any evident in the immediate vicinity (Historic England Listing Map, 2021).</p>	
<p>Barriers to Delivery and Mitigation (including ownership constraints - if known)</p>	<p>As the site is occupied there may be constraints in relation to availability of land. Any future redevelopment should seek to ensure that the impact of neighbouring uses is fully taken into account.</p> <p>Potential contamination issues at the site would need to be investigated and mitigated if necessary.</p>	Average
<p>Market Attractiveness (including appropriateness, vacancy and market activity on site for the type of development proposed)</p>	<p>The site is adjacent to the Middlebeck strategic allocation and the delivery of the southern link road between the A46 and A1 will significantly improve strategic road access. The site accommodates some significant businesses and a modern industrial development. Vacancy levels were low at the time of the site visit. There is a vacant site of 2.48 ha currently subject to a planning application for residential development. The site is in close proximity to residential areas which is likely to bring it in conflict with residential amenity.</p>	Average / Poor
<p>Strategic Fit with Growth Area Objectives (by target Market Segment)</p>	<p>This site already accommodates key industrial growth sectors as identified in the D2N2 Vision 2030 document including construction and extractive industries.</p>	Average
<p>OVERALL SITE RATING</p>	<p>Average</p>	
<p>Recommendation and Potential Future Uses</p>	<p>Consider releasing for Alternative Uses</p> <p>The site is an established employment area containing a range of businesses primarily in the construction and extractive industries. However, there are a number of housing allocations within the site which would be incompatible with ongoing construction and extractive uses. Albeit, it is understood that the largest extractive use has indicated they would be prepared to relocate.</p> <p>It is recommended that the Council considers releasing this site for alternative uses, although the potential economic impact of a change of use of this large site should not be under-estimated. The Council would need to consider/help to facilitate occupiers relocating to more suitable and accessible locations elsewhere in the District. This will require careful consultation with existing occupiers of the site.</p>	
<p>SITE SUMMARY:</p>		
<p>This site is primarily occupied by construction and extractive industries as well as a modern</p>		

industrial development – Balderton Business Park. The site is fully developed including a modern industrial park – Balderton Business Park, the only vacant land is site NUA/Ho/8. The site is immediately to the north of the ‘Middlebeck’ sustainable urban extension comprising of up to 3,150 homes. Bellway and Avant Homes are bringing forward sites immediately south of the site.

The site is allocated under policy NUA/Ho/7 (Newark Urban Area – Bowbridge Road Policy Area), within this area, proposals to redevelop vacant brownfield sites will be encouraged. Two areas within the site are allocated for residential development - NUA/Ho/8 is vacant and pending planning permission for residential development and NUA/Ho/9 is occupied by employment uses. Given, the housing allocations within the site, it is recommended that further consideration be given to releasing this site from the employment land portfolio.

FlowsERVE Pump Division, Hawton Lane (Ref: NSDC6)



**GROSS SITE AREA:
12.50 ha**

**ESTIMATED NET DEVELOPABLE
AREA:
0 ha**

CRITERIA

COMMENT

RATING

Site Context

- Location with regards to existing employment areas and other sites
- How the site fits into the overall portfolio

This is a cleared development site formerly occupied by buildings associated with the adjacent FlowsERVE Corporation (manufacturer of pumps and pumping equipment).

The site is south of the Bowbridge Road Policy Area and west of the Land South of Newark strategic allocation, the first phases are under construction.

Local Plan Designation

The Development Plan for the District comprises of the Amended Core Strategy (adopted 7th March 2019) and Allocations & Development Management (adopted 16 July 2013) Development Plan Document. The site is unallocated land within the Newark Urban Area (Policy NAP1). In the middle of the site is an area of land designated for public open space/school playing fields (Core Strategy Spatial Policy 8).

The site is bound by a Strategic Site to the south-east (Land south of Newark - NAP 2A, Amended Core Strategy, 2019). The sustainable urban extension comprises of up to 3,150 new homes, a strategic link road between the A1 and A46 and 49 ha of employment, as well as community facilities and open spaces. Outline permission has been granted for the wider development known as 'Middlebeck' with reserved matters permission for the first phases, development of these is underway.

The Newark Southern Link Road (NAP 4, Amended Core

	<p>Strategy, 2019) passes the Flowserve Pump Division site at the south-east corner.</p> <p>To the west of the site is a Site of Interest in Nature Conservation (Core Policy 12 and DM7) with an allocation for housing beyond (NUA/Ho/10 – Newark Urban Area – Housing Site 10, Allocations & Development Management DPD, 2013).</p>
Status in SHLAA	Site Ref: Flowserve, Hawton Lane (08_0434). Planning permission has been granted for 210 dwellings. The site is suitable.
Planning History	<p>Recent planning history includes:</p> <ul style="list-style-type: none"> • 18/01235/FULM - Demolition of buildings, new drainage pond and watercourse to create development site - 13ha (approx.). Note - The planning application sought full planning permission for the Demolition of existing buildings, remediation of site, formation of drainage pond, diversion of culvert and raising of ground levels to create a development site for future residential development. • 19/SCR/00007 EIA Screening request for residential development • 19/00854/OUTM Outline application with all matters reserved except access for up to 322-unit residential development on land at Flowserve premises – Refused – 06.08.2020 – On the grounds that the proposals represented unsustainable development due to the significant level of development proposed and lack of full and appropriate mitigation measures in terms of the provision of any affordable housing, community facilities, health care, public open space, libraries and transport improvements. This decision is currently subject to appeal. • 19/00752/DEM Demolition of Simpson Building, Worthington Building, Main Building, Water Tank and Building, Gas Governor Building and Security Building • 12/00561/OUTM - Application for a new planning permission to replace an extant planning permission, 07/01840/OUTM (for 210 homes) – Granted 07.03.2013
Current Use and Land Type	This is primarily a brownfield site formerly occupied by buildings associated with the adjacent industrial premises. It is now a cleared development site. There are areas of undeveloped greenfield land within the northern and eastern portion of the site.
Occupier Profile (if partly developed, including % of available land and levels of vacancy onsite)	This is a cleared development site formerly occupied by buildings associated with the adjacent Flowserve Corporation (manufacturer of pumps and pumping equipment).

<p>Strategic Road Access</p>	<p>The A1 is approximately 2.1km from the site via Hawton Lane and the B6326 (London Road).</p>	<p>Poor</p>
<p>Local Road Access</p>	<p>Access to the site is via Hawton Lane to the North. Hawton Lane is a residential road and the access road itself passes behind a residential estate.</p> <p>The A1 can be accessed via Hawton Lane and the B6326 (London Road). London Road passes through the residential town of Balderton en route to the A1.</p>	<p>Average</p>
<p>Proximity to Urban Areas and Access to Labour and Services (including public transport / cycling / walking accessibility)</p>	<p>The site is situated approximately 2.2km South East from the centre of the residential town of Newark-upon-Trent and approximately 1.6km West from the centre of the smaller residential town of Balderton/New Balderton. Balderton provides schools, a medical centre and local shops and amenities.</p> <p>Newark on Trent provides a wide range of services and amenities including a hospital, schools, a shopping centre, retail park, restaurants and various recreational facilities. The nearest bus stops providing regular services to Newark and Balderton are 0.5km from the site entrance on Hawton Lane.</p> <p>Newark Castle railway station is approximately 4.3km from the site and provides regular train services to Lincoln and Nottingham. Newark Northgate railway station is approximately 3.7km from the site and provides regular train services towards Nottingham, Lincoln and London. Neither train station is directly accessible by public transport however, National Cycle Route 64 along the West of the site continues directly through to Newark Northgate station.</p>	<p>Good / Average</p>
<p>Compatibility of Adjoining Uses (including amenity impacts experienced by current/future occupiers and neighbouring areas)</p>	<p>The site is bordered by Flowserve Sports and Social club and associated recreational land to the North with residential areas beyond (Hawton Lane also borders the very top of the site to the North), greenfield land to the South and East and National Cycle Route 64 to the West with residential areas beyond.</p>	<p>Average / Poor</p>

<p>Developmental and Environmental Constraints (e.g. size; topography; site access; roads, lighting, landscaping, mains utilities and communications infrastructure; flood risk; contamination; nature and heritage conservation)</p>	<p>A public right of way crosses the site and a cycle route follows the former railway to west.</p> <p>There are possible contamination issues.</p> <p>Substantial areas of the site are within Flood zone 2 and 3, Middlebeck channel passes through site and Lowfield drain to south. This could limit the developable area significantly.</p> <p>The site is not subject to any grade listed structures nor are there any located within the immediate vicinity (Historic England Listing Map, 2021).</p>	<p>Poor</p>
<p>Barriers to Delivery and Mitigation (including ownership constraints - if known)</p>	<p>The site is close to residential properties and a sports facility and amenity impacts upon these users would need consideration. Contamination and flooding issues would need to be addressed.</p>	<p>Poor</p>
<p>Market Attractiveness (including appropriateness, vacancy and market activity on site for the type of development proposed)</p>	<p>The site is adjacent to the Middlebeck strategic allocation and the delivery of the southern link road between the A46 and A1 will significantly improve strategic road access. The site has a historical permission for residential development. It is considered more suitable for residential uses.</p>	<p>Poor</p>
<p>Strategic Fit with Growth Area Objectives (by target Market Segment)</p>	<p>This site has a historical permission for residential development and is currently subject to appeal for a decision to refuse permission for residential development - realistically it is more likely to come forward for housing.</p>	<p>Poor</p>
<p>OVERALL SITE RATING</p>	<p>Poor</p>	
<p>Recommendation and Potential Future Uses</p>	<p>Consider releasing for alternative uses</p>	
<p>SITE SUMMARY:</p>		
<p>This is a cleared development site formerly occupied by buildings associated with the adjacent Flowserve Corporation (manufacturer of pumps and pumping equipment). The site is south of the Bowbridge Road Policy Area and west of the Land South of Newark strategic allocation, the first phases are under construction. The site has a historical permission for residential development of 210 homes.</p> <p>The site is currently subject to an appeal against the refusal of permission for 322 homes. There are a number of constraints which would require mitigation, namely the flood risk associated with Middlebeck which intersects the site and the Lowfield drain to the south as well as remediation for any potential contamination.</p> <p>Subject to addressing the constraints of the site, it is considered more suitable for residential development. It is recommended that the site be released for alternative uses, most likely housing.</p>		

Land North and South of Cross Lane (Ref: NSDC7)



GROSS SITE AREA:
7.77 ha

ESTIMATED NET DEVELOPABLE AREA:
7.38 ha
(Note: based on a 95% gross to net ratio adjustment)

CRITERIA	COMMENT	RATING
<p>Site Context</p> <ul style="list-style-type: none"> • Location with regards to existing employment areas and other sites • How the site fits into the overall portfolio 	<p>This is an undeveloped site located within the partially developed Fernwood Business Park. Occupiers include a school, assisted living facility, gym, restaurant and modern office development.</p> <p>The site is immediately north of a strategic site within the NAP2C Land Around Fernwood Allocation and immediately to the east of the Middlebeck sustainable urban extension.</p>	
<p>Local Plan Designation</p>	<p>The Development Plan for the District comprises of the Amended Core Strategy (adopted 7th March 2019) and Allocations & Development Management (adopted 16th July 2013) Development Plan Document.</p> <p>The site is located within the Strategic Site allocation (<i>NAP 2C Land around Fernwood and Core Strategy Spatial Policy 5</i>); it is identified for Use Class E office development. It is also included within the Newark Urban Area – Phasing Policy (NUA/Ph/1) (Allocations & Development Management DPD, 2013).</p> <p>The Newark Southern Link Road (Core Strategy NAP 4) adjoins the B6326 to the north-west of the site.</p> <p>The site is also contained within the urban boundary/village envelope (DM1) within the Newark & Sherwood Local Development Framework Policies Map.</p> <p>The site is included within the ‘Fernwood Parish Neighbourhood Plan’ (2016-2031) boundary. There are no specific employment policies within the plan, however</p>	

	Community Objective 9 states a requirement for Pre-Application Community Consultation.	
Status in SHLAA	N/A	
Planning History	Recent planning history includes: 07/01081/OUTM - B1 Business development of up to 47,500 square metres - 12.78 ha /127,788 sqm	
Current Use and Land Type	This is an undeveloped greenfield site.	
Occupier Profile (if partly developed, including % of available land and levels of vacancy onsite)	<p>The site is undeveloped, although areas of land around the site have been developed as follows:</p> <ul style="list-style-type: none"> To the north of the site adjacent to the B6326 are the Marstons Restaurant and Code Fitness Gym. Within the centre of the site off the northern roundabout is a modern office development – Halifax Court including Fernwood Business Centre, A8 Managed Technologies, Fisher German, The Advertiser, Symphony Retail, DJ Swallow and EHS Data. <p>A few units were available from 96.15 sqm – 566.71 sqm.</p> <ul style="list-style-type: none"> To the south of cross lane off the southern roundabout are The Suthers School, Lancaster Grange Assisted Living and Spectrum Wellness and Performance. <p>The western parcel of land (2.13 ha) to the north of Cross Lane was being marketed by JLL as a commercial development opportunity for offices.</p>	
Strategic Road Access	The A1 runs adjacent to the site to the West and can be accessed via a junction with the B6326.	Very Good
Local Road Access	Access to the site is via Cross Lane through the centre of the site and William Hall Way to the North-East. Both are off the B6326 which is a good free-flowing road which shares junctions with the A1 to the North and South. Alongside the planned expansion of Fernwood there will be junction improvements and the A1 overbridge which will improve local road access.	Very Good
Proximity to Urban Areas and Access to Labour and Services (including public transport / cycling / walking accessibility)	<p>There is a Marstons Restaurant and Code Fitness gym immediately north of the site. The site is adjacent to the residential village of Fernwood, a small, recently built village with basic local shops and amenities.</p> <p>The larger residential town of Balderton/New Balderton lies towards the North West of the site approximately 1km away via the B6326. Balderton provides schools, a medical centre and local shops and amenities.</p> <p>The town of Newark on Trent is approximately</p>	

	<p>5km from the site via the B6326. Newark on Trent provides a wide range of services and amenities including a hospital, schools, a shopping centre, retail park, restaurants and various recreational facilities.</p> <p>There is a limited irregular bus service from the B6326 at the entrance to the site to Newark/Balderton and Grantham.</p>	
<p>Compatibility of Adjoining Uses (including amenity impacts experienced by current/future occupiers and neighbouring areas)</p>	<p>The site is part of a larger site including a school, gym, restaurant and assisted living facility. The A1 borders the site as a whole to the West with the B6326 and the village of Fernwood to the North and East and greenfield land to the South.</p>	Average
<p>Developmental and Environmental Constraints (e.g. size; topography; site access; roads, lighting, landscaping, mains utilities and communications infrastructure; flood risk; contamination; nature and heritage conservation)</p>	<p>This is a level site adjacent to the partially developed Fernwood Business Park.</p> <p>Possible habitat of Watervoles.</p> <p>A review of Flood Maps for Planning (Gov.uk, 2021) shows the site is not located within a Flood Zone.</p> <p>The site is not subject to any grade listed structures nor are any located within the immediate locality (Historic England Listing Map, 2021).</p>	Very Good
<p>Barriers to Delivery and Mitigation (including ownership constraints - if known)</p>	<p>Vehicular access to the site would need to be created from the spine roads within the wider site. Consideration of adjoining uses, primarily The Suthers School and Lancaster Grange Assisted Living. No other barriers to development were evident from the site visit.</p>	Good
<p>Market Attractiveness (including appropriateness, vacancy and market activity on site for the type of development proposed)</p>	<p>This is a level site adjacent to the partially developed Fernwood Business Park with good visibility from the adjacent A1. It would be attractive to a range of occupiers.</p>	Very Good
<p>Strategic Fit with Growth Area Objectives (by target Market Segment)</p>	<p>This site has potential to accommodate key industrial growth sectors as identified in the D2N2 Vision 2030 document.</p>	Average
<p>OVERALL SITE RATING</p>	<p>Very Good</p>	
<p>Recommendation and Potential Future Uses</p>	<p>Allocate for employment uses</p> <p>Retain strategic site allocation (Land around Fernwood – NAP 2C) for Use Class E office development.</p>	

	<p>However, in reality, it is unlikely that the whole site will come forward for Use Class E office development and there is likely to be an element of mixed-use development, the following possible alternative uses could be considered:</p> <ul style="list-style-type: none"> • Uses within Use Class E- Commercial, Business and Service, although the Council may wish to exclude Class E(a) retail; • Class C1 Hotels; • Class C2 Residential Institutions; • Class F1 Learning and Non-Residential Institutions; • Specific Sui-generis uses e.g. Public Houses/ Drinking Establishments with Expanded Food Provision (formerly Class A4) and Hot Food Takeaways (formerly Class A5). <p>It is not the purpose of this study to determine the split of these uses.</p>
--	--

SITE SUMMARY:

This is an undeveloped grassland site within the wider Fernwood Business Park site adjacent to the A1. It is immediately to the east of the Middlebeck sustainable urban extension. There is no existing vehicular access to the site, but there is potential for access from existing roads within the wider site. This site has potential to accommodate key industrial growth sectors and would likely be attractive to a range of occupiers. It is recommended that the site is allocated for employment uses i.e. the strategic site allocation NAP 2C Land around Fernwood (Core Strategy, 2019) is retained for development of the wider site for use Class E offices. However, in reality, it is unlikely that the whole site will come forward for Use Class E office development and there is likely to be an element of mixed-use development.

Staythorpe Power Station (Ref: NSDC8)



GROSS SITE AREA:
74.35 ha

ESTIMATED NET DEVELOPABLE AREA:
5.51 ha
(Note: comprising of land within the south west of the site, 95% gross to net adjustment applied)

CRITERIA	COMMENT	RATING
<p>Site Context</p> <ul style="list-style-type: none"> • Location with regards to existing employment areas and other sites • How the site fits into the overall portfolio 	<p>This is the site of two former coal-fired power plants which is now occupied by National Grid Substations and the Staythorpe Power Plant – a gas-fired combined-cycle gas turbine power plant. This is a relatively remote site in a rural location. Newark on Trent is approximately 6.5km east of the site.</p>	
<p>Local Plan Designation</p>	<p>The Development Plan for the District comprises of the Amended Core Strategy (adopted 7th March 2019) and Allocations & Development Management (adopted 16 July 2013) Development Plan Document.</p> <p>The site is not allocated within the Local Development Framework.</p> <p>The power station itself is designated as a hazardous installation (DM10, Allocations & Development Management DPD, 2013) and the River Trent that flows along the southern border of the site is recognised as a Site of Interest in Nature Conservation (Core Policy 12 and DM7).</p>	
<p>Status in SHLAA</p>	<p>N/A</p>	
<p>Planning History</p>	<p>Recent planning applications:</p> <ul style="list-style-type: none"> • 20/SCR/00004 – Screening Request for Proposed Emergency Back-up Generating Plant 	
<p>Current Use and Land Type</p>	<p>This is a brownfield site in use for energy-generation.</p>	

<p>Occupier Profile (if partly developed, including % of available land and levels of vacancy onsite)</p>	<p>The north of the site is occupied by the National Grid Staythorpe Report Centre 132kv and 400kv Substations. The south of the site is occupied by the Staythorpe Power Plant – a gas-fired combined-cycle gas turbine power plant that began commercial operation towards the end of 2010.</p> <p>There is an undeveloped area of land (approximately 5.8ha) adjacent to the western boundary and south of the drainage pond (adjacent to the site recently identified for an Emergency Back-up Generating Plant ref. 20/SCR/00004 – comprising of 0.79ha) which may be suitable for redevelopment for employment uses. Albeit there are a number of electricity pylons within the site and overhead lines intersect the majority of the site.</p>	
<p>Strategic Road Access</p>	<p>The A617 within 0.7km of the site. The A1 is approximately 8km from the site via the A617 and A46.</p>	<p>Poor</p>
<p>Local Road Access</p>	<p>Access to the site is via Staythorpe Road which is a good free-moving road which joins the A617 within 0.7 km of the site Northbound. Southbound, Staythorpe Road continues past the site and into the residential village of Rolleston.</p>	<p>Average</p>
<p>Proximity to Urban Areas and Access to Labour and Services (including public transport / cycling / walking accessibility)</p>	<p>There are a number of small residential villages/residential sites within 2km of the site including Rolleston. There are no shops and few amenities.</p> <p>The town of Newark on Trent is approximately 6.5 km from the site via the A617 and B6326.</p> <p>Newark on Trent provides a wide range of services and amenities including a hospital, schools, a shopping centre, retail park, restaurants and various recreational facilities.</p> <p>Bus stops are less than 0.2km from the site entrance on Staythorpe Road provide a limited irregular bus service to Newark on Trent to the East and Mansfield to the North West.</p>	<p>Poor</p>
<p>Compatibility of Adjoining Uses (including amenity impacts experienced by current/future occupiers and neighbouring areas)</p>	<p>The site is bordered by Staythorpe Road to the North West, a small residential area to the North, the River Trent to the South and greenfield land to the North, East and West. A railway line intersects the centre of the site.</p>	<p>Average</p>
<p>Developmental and Environmental Constraints (e.g. size; topography; site access; roads, lighting, landscaping, mains utilities and communications)</p>	<p>This is a large, gently undulating site, which slopes gently from north to south down to the River Trent.</p> <p>A review of Flood Maps for Planning (Gov.uk,</p>	<p>Very Poor</p>

<p>infrastructure; flood risk; contamination; nature and heritage conservation)</p>	<p>2021) shows the site is located within a Flood Zone 2 and 3. The site is adjacent to the River Trent, Rundell Dyke runs adjacent to the access road and there are drainage ponds within the site.</p> <p>The site is not subject to any listed structures nor are there any located in the immediate locality (Historic England Listing Map, 2021).</p> <p>Likely contamination due to previous site uses.</p> <p>A railway line intersects the site and may constrain future redevelopment. The site is also intersected by overhead lines and multiple pylons are located within the site.</p>	
<p>Barriers to Delivery and Mitigation (including ownership constraints - if known)</p>	<p>Any redevelopment of the site would need to mitigate against flood risk and any probable land contamination may require remediation.</p>	<p>Very Poor</p>
<p>Market Attractiveness (including appropriateness, vacancy and market activity on site for the type of development proposed)</p>	<p>This is a remote site in a rural location, Newark on Trent is approximately 6.5km east of the site. The site is occupied by electricity substations and a gas-fired power plant. Any redevelopment would be constrained by the undulating topography, flood risk, railway, pylons and overhead lines intersecting the site and potential contamination.</p>	<p>Poor</p>
<p>Strategic Fit with Growth Area Objectives (by target Market Segment)</p>	<p>This site is in a rural location 6.5km from Newark-on-Trent. It serves an important function in accommodating national grid substations and a gas-fired power station.</p>	<p>Average</p>
<p>OVERALL SITE RATING</p>	<p>Poor</p>	
<p>Recommendation and Potential Future Uses</p>	<p>Do not allocate for employment uses</p>	
<p>SITE SUMMARY:</p>		
<p>This site was formerly in use by two former coal-fired power plants, it is now occupied by National Grid Substations and the Staythorpe Power Plant – a gas-fired combined-cycle gas turbine power plant. This is a relatively remote site in a rural location, Newark on Trent is approximately 6.5km east of the site. Any redevelopment would be constrained by the undulating topography, flood risk, a railway line and overhead lines intersecting the site and potential contamination. The site is not allocated within the Local Plan and it is not recommended that it is not allocated for employment uses.</p>		

Staunton Works, Alverton Road (Ref: NSDC9)



**GROSS SITE AREA:
6.78 ha**

**ESTIMATED NET DEVELOPABLE AREA:
1.8 ha**

CRITERIA	COMMENT	RATING
<p>Site Context</p> <ul style="list-style-type: none"> • Location with regards to existing employment areas and other sites • How the site fits into the overall portfolio 	<p>This is a small industrial estate located in a rural setting. The site is approximately 4.5km directly south of NAP2A Land south of Newark strategic site comprising of up to 3,150 new homes, a strategic link road between the A1 and A46 and 49 ha of employment, as well as community facilities and open spaces.</p> <p>Outline permission has been granted for the wider development known as 'Middlebeck' with reserved matters permission for the first phases, development of these is underway.</p>	
<p>Local Plan Designation</p>	<p>The Development Plan for the District comprises of the Amended Core Strategy (adopted 7th March 2019) and Allocations & Development Management (adopted 16 July 2013) Development Plan Document.</p> <p>The site is not allocated within the Local Development Framework.</p> <p>The site is located within the open countryside as defined in the Newark & Sherwood Local Development Framework Policies Map and the site immediately neighbours a Site of Interest in Nature Conservation (Core Policy 12 and DM7) to the south.</p>	
<p>Status in SHLAA</p>	<p>N/A</p>	
<p>Planning History</p>	<p>Recent planning history includes:</p> <ul style="list-style-type: none"> • 16/00316/FULM - Erection of 6 poultry buildings - 5.98ha/ 59759m2 • 09/00995/FULM - CU for storage - 5.96ha/ 59,637 	

	<p>sqm</p> <ul style="list-style-type: none"> • 19/00761/FULM - Erection of building to provide covered loading - 0.91ha/ 9139m2 • 	
Current Use and Land Type	This is a brownfield site occupied by an industrial estate.	
Occupier Profile (if partly developed, including % of available land and levels of vacancy onsite)	<p>The site accommodates dated industrial workshops, some in poor condition and storage space. Occupiers include Farrells Transport distribution warehouse and depot, United Garden Buildings, Pegasus Pump manufacturer and MH Motors vehicle repair. All units appeared to be occupied at the time of the site visit (December 2020).</p> <p>Approximately 1.8 ha of land within the eastern half of the site is undeveloped.</p>	
Strategic Road Access	<p>The A1 is approximately 5 km to the east of the site via Alverton Road and Valley Lane.</p> <p>As part of the Middlebeck proposals, there is a new southern link road proposed between the A46 and A1, albeit this will be quite a distance north of this site.</p>	Very Poor
Local Road Access	<p>There are 2 access roads onto the site, both off Alverton Road - a narrow, two-lane rural road. The A1 can be reached by either following Alverton Road to the North and then Valley Lane, or by following Alverton Road to the South and then High Street. These roads are narrow rural roads constrained by speed restrictions though residential areas and restricted access for 7.5 tonne vehicles.</p> <p>As part of the Middlebeck proposals, the access to the NAP2A strategic site to the north via Grange Lane is proposed to be upgraded. If this was extended south down Grange Lane, it would significantly benefit this site.</p>	Very Poor
Proximity to Urban Areas and Access to Labour and Services (including public transport / cycling / walking accessibility)	<p>The residential village of Long Bennington is approximately 5km from the site to the East and can be reached by following (Alverton Road) to the North and then Valley Lane. Long Bennington provides schools, a medical centre and various local shops and amenities.</p> <p>The larger residential town of Newark on Trent is approximately 9km to the North of the site via the A1 and B6326. Newark provides a wide range of services and amenities including a hospital, schools, a shopping centre, retail park, restaurants and various recreational facilities.</p> <p>There are very limited and irregular bus services</p>	Very Poor

	<p>from Riverside Cottage approximately 0.6km from the site which service Long Bennington and Newark.</p> <p>The National Cycle Route 64 follows along the West of the site and continues directly through to Newark but is not directly accessible from the site.</p>	
<p>Compatibility of Adjoining Uses (including amenity impacts experienced by current/future occupiers and neighbouring areas)</p>	<p>The site is bordered by greenfield land in all directions with National Cycle Route 64 along the West of the site.</p>	Very Good
<p>Developmental and Environmental Constraints (e.g. size; topography; site access; roads, lighting, landscaping, mains utilities and communications infrastructure; flood risk; contamination; nature and heritage conservation)</p>	<p>This is an existing small industrial estate with communications and utilities infrastructure in place and the site is level.</p> <p>The site is within the open countryside and there is a Local Wildlife Site and Site of Interest in Nature Conservation approximately 100m west of the site.</p> <p>A review of Flood Maps for Planning (Gov.uk, 2021) shows a Flood Zone 2/3 designation within the western half of the site.</p> <p>There are several listed buildings within 1km of the site.</p>	Poor
<p>Barriers to Delivery and Mitigation (including ownership constraints - if known)</p>	<p>Any development of the site would need to mitigate flood risk and impact upon local environmental and heritage designations.</p>	Poor
<p>Market Attractiveness (including appropriateness, vacancy and market activity on site for the type of development proposed)</p>	<p>This is small, rural industrial estate. Some of the units could benefit from improvements. Due to the relatively isolated location of this site, it is less likely to be attractive to a range of occupiers. Delivery of the NAP2A Land south of Newark a strategic Site is progressing approximately 4.5km north of the site.</p>	Poor
<p>Strategic Fit with Growth Area Objectives (by target Market Segment)</p>	<p>This site already accommodates a logistics business, logistics is identified as a key industrial growth sector in the D2N2 Vision 2030 document. The site is in a rural and isolated location, with limited potential to accommodate other key industrial growth sectors.</p>	Poor
<p>OVERALL SITE RATING</p>	Poor	
<p>Recommendation and Potential Future Uses</p>	Do not allocate for employment uses	

SITE SUMMARY:

This is a small industrial estate located in open countryside. The site is approximately 4.5km directly south of NAP2A Land south of Newark strategic site. Local road access is via narrow rural roads and the A1 is approximately 5km away. This is an isolated site, the nearest village being approximately 5km away. The site accommodates a logistics business and a number of smaller workshops which appeared to be occupied, albeit would benefit from improvements.

Approximately 1.8ha of the site remains undeveloped. The site is constrained by flood risk and there are also a number of heritage and environmental designations in close proximity. The site is not allocated within the Local Development Framework and it is not recommended that it be allocated.

Caledonian, Carlton Works (Ref: NSDC10)



GROSS SITE AREA:
17.12 ha

ESTIMATED NET DEVELOPABLE AREA:
0 ha

CRITERIA	COMMENT	RATING
<p>Site Context</p> <ul style="list-style-type: none"> • Location with regards to existing employment areas and other sites • How the site fits into the overall portfolio 	<p>This site is occupied by Caledonian Modular (home builder). The site is located adjacent to the A1, in a relatively rural location in the north of district. It is approximately 2.5 km south of the ST/E/1 employment site.</p>	
<p>Local Plan Designation</p>	<p>The Development Plan for the District comprises of the Amended Core Strategy (adopted 7th March 2019) and Allocations & Development Management (adopted 16 July 2013) Development Plan Document.</p> <p>The site is not allocated within the Local Development Framework nor is it subject to any planning constraints.</p> <p>Beyond the A1, to the south-east, is a Conservation Area (Core Policy 14 and DM9).</p>	
<p>Status in SHLAA</p>	<p>N/A</p>	
<p>Planning History</p>	<p>Recent planning history includes: 07/01866/FULM - Erection of two extensions to factory building - 1476m²</p>	
<p>Current Use and Land Type</p>	<p>This is a brownfield site occupied by employment uses.</p>	
<p>Occupier Profile (if partly developed, including % of available land and levels of vacancy onsite)</p>	<p>This site is fully developed and occupied by Caledonian Modular home builder head office and manufacturing facility.</p>	

Strategic Road Access	The site is directly adjacent to the A1 which shares a junction with the site's access road (B1164 Ossington Road) within 0.2km of the site entrance.	Very Good
Local Road Access	<p>The site is accessed via 2 entrances (one servicing the Eastern site and one servicing the Western site) off the B1164 Ossington Road. The B1164 is a good, free-flowing but rural road which passes through some residential areas and a level crossing situated just outside the site between the 2 access roads.</p> <p>The narrow road (Main Street) off Ossington Road traveling South from the site towards Norwell is considered unsuitable for heavy goods vehicles.</p>	Good
Proximity to Urban Areas and Access to Labour and Services (including public transport / cycling / walking accessibility)	<p>The site is situated approximately 0.5km from the small residential village of Carlton-on-Trent to the East and approximately 2.3km from the larger residential village of Sutton on Trent to the North East. There are no local shops or amenities within Carlton-on-Trent but Sutton on Trent provides a Primary school and local shops and amenities.</p> <p>The larger residential town of Newark on Trent is approximately 15km to the South of the site via the A1. Newark provides a wide range of services and amenities including a hospital, schools, a shopping centre, retail park, restaurants and various recreational facilities.</p> <p>The site is serviced by local buses between 8am and 6pm. Ferry Lane bus stop heading North (0.5 from the site entrance on Ossington Road) provides hourly services to Tuxford/Retford. Ferry Lane bus stop heading South (0.6km from the site entrance on Ferry Lane) provides hourly services to Newark centre.</p>	Very Poor
Compatibility of Adjoining Uses (including amenity impacts experienced by current/future occupiers and neighbouring areas)	<p>The site is bordered by the A1 to the East/North and a farm and associated greenfield land to the North, South and West. The East Coast Main Line travels through the centre of the site effectively separating the site into East and West sections.</p> <p>There are residential properties approximately 85 metres away.</p>	Very Good
Developmental and Environmental Constraints (e.g. size; topography; site access; roads, lighting, landscaping, mains utilities and communications)	<p>This is a large, relatively level site occupied by employment uses with communications and utilities infrastructure in place.</p> <p>A review of Flood Maps for Planning (Gov.uk,</p>	Very Good

infrastructure; flood risk; contamination; nature and heritage conservation)	2021) shows the site is not located within a flood zone. A Flood Zone 2 however is located beyond the A1 to the east. The site is not subject to any listed structures nor are there any within the immediate locality (Historic England Listing Map, 2021).	
Barriers to Delivery and Mitigation (including ownership constraints - if known)	The East Coast Main Line travels through the centre of the site and may be a constraint to any future redevelopment of the site. No other barriers to redevelopment were evident from the site visit.	Good
Market Attractiveness (including appropriateness, vacancy and market activity on site for the type of development proposed)	The site is fully occupied and conveniently located adjacent to a junction of the A1.	Good
Strategic Fit with Growth Area Objectives (by target Market Segment)	This site already accommodates key industrial growth sectors as identified in the D2N2 Vision 2030 document including construction.	Good
OVERALL SITE RATING	Good	
Recommendation and Potential Future Uses	Protect for employment uses	
SITE SUMMARY:		
This site is occupied by Caledonian Modular (home builder). The site is located in a relatively rural location in the north of district. The site is directly adjacent to the A1 which shares a junction with the site's access road within 0.2km of the site entrance. The East Coast Main Line travels through the centre of the site and may be a constraint to any future redevelopment. The site is not allocated in the Local Plan and it is recommended that it is protected for employment uses going forward.		

Land off Old Great North Road (ST/E/1) (Ref: NSDC11)

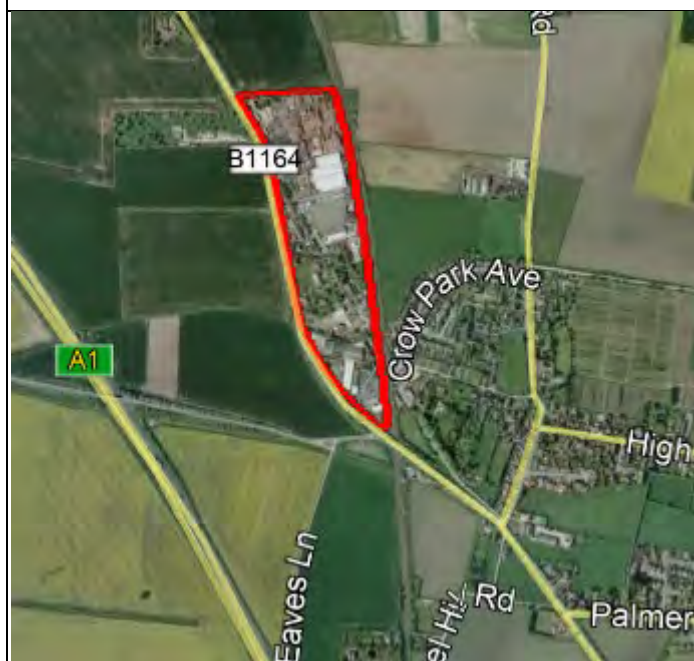

GROSS SITE AREA:
9.53 ha

ESTIMATED NET DEVELOPABLE AREA:
0 ha

CRITERIA	COMMENT	RATING
<p>Site Context</p> <ul style="list-style-type: none"> • Location with regards to existing employment areas and other sites • How the site fits into the overall portfolio 	<p>This site is primarily occupied by garden products and outdoor buildings manufacturers, distribution centres and showrooms. The site is located in within the village of Sutton on Trent, in the north of district. It is approximately 2.5 km north of the Caledonian Modular, Carlton Works site.</p>	
<p>Local Plan Designation</p>	<p>The Development Plan for the District comprises of the Amended Core Strategy (adopted 7th March 2019) and Allocations & Development Management (adopted 16 July 2013) Development Plan Document. The site is identified as an Industrial Estate/Existing Employment Policy Area (ref. ST/EA/1).</p> <p>The site also borders a Conservation Area (Core Policy 14 and DM9) to the east.</p>	
<p>Status in SHLAA</p>	<p>N/A</p>	
<p>Planning History</p>	<p>Recent planning history includes:</p> <ul style="list-style-type: none"> • 17/01976/FULM - Storage unit attached to current factory unit - 4.12ha/41215m² • 17/01977/FULM - Steel extension to factory unit - 4.12ha/41215m² • 16/01221/FUL - new ancillary office, training room and toilet facility - 0.90ha/9036m² 	
<p>Current Use and Land Type</p>	<p>This is a brownfield site in employment use.</p>	
<p>Occupier Profile (if partly developed, including % of available land and levels of vacancy onsite)</p>	<p>This site is primarily occupied by manufacturers of garden products and buildings – Mercia Garden Products, BVG Group and Waltons. Other occupiers include Gardener Team Motorsport Race and Trailers (trailer hire and sale)</p>	

	and Marshalls of Sutton on Trent Bus Depot. There are also a number of smaller workshop units on Old Great North Road, all units appeared to be occupied at the time of the site visit (December 2020).	
Strategic Road Access	The A1 is accessible approximately 3.2km South and 7.2km North from the site via the B1164.	Average / Poor
Local Road Access	The site is accessed via Old Great North Road off the B1164 (Great North Road). The B1164 is a good, free-flowing road however, it is constrained by speed limits and junctions through residential areas.	Average
Proximity to Urban Areas and Access to Labour and Services (including public transport / cycling / walking accessibility)	<p>The site is on the outskirts of the residential village of Sutton-on-Trent to the East/South East. Sutton-on-Trent provides a Primary school and local shops and amenities.</p> <p>The larger residential town of Newark on Trent is approximately 17km to the South of the site via the A1. Newark provides a wide range of services and amenities including a hospital, schools, a shopping centre, retail park, restaurants and various recreational facilities.</p> <p>The site is serviced by local buses between 8am and 5:30pm. There are 2 “Great North Road” bus stops just outside the site entrance on Great North Road which, heading North, provide hourly services to Retford and, heading South, provide hourly services to Newark centre.</p>	Very Poor
Compatibility of Adjoining Uses (including amenity impacts experienced by current/future occupiers and neighbouring areas)	<p>The site is bordered to the West and South by the B1164 with greenfield land beyond, to the East by the East Coast Main Line with greenfield land and the village of Sutton-on-Trent beyond, and to the North by greenfield land.</p> <p>There are residential properties within the Employment Policy Area and the policy seeks to manage this conflict.</p>	Poor
Developmental and Environmental Constraints (e.g. size; topography; site access; roads, lighting, landscaping, mains utilities and communications infrastructure; flood risk; contamination; nature and heritage conservation)	<p>This site is a level site occupied by employment uses with utilities and communications infrastructure in place.</p> <p>The railway line bounds the site to the east and there are residential dwellings adjacent to the site.</p> <p>A review of Flood Maps for Planning (Gov.uk, 2021) shows the site is not located within a flood Zone.</p> <p>The site is not subject to any listed structures nor</p>	Good

	are there any in the immediate locality (Historic England Listing Map, 2021).	
Barriers to Delivery and Mitigation (including ownership constraints - if known)	Any redevelopment would need to take into consideration the amenity impacts upon neighbouring residential properties. The adjacent railway line may also constrain development. This is a fully developed site and no other barriers to redevelopment were evident from the site visit.	Good
Market Attractiveness (including appropriateness, vacancy and market activity on site for the type of development proposed)	The site is occupied by garden products manufacturers and a number of worksops. There were low vacancy levels on the site at the time of the site visit.	Average
Strategic Fit with Growth Area Objectives (by target Market Segment)	This site already accommodates key industrial growth sectors as identified in the D2N2 Vision 2030 document including construction.	Average
OVERALL SITE RATING	Average	
Recommendation and Potential Future Uses	Protect for employment uses	
SITE SUMMARY:		
<p>This site is primarily occupied by garden products and outdoor buildings manufacturers, distribution centres and showrooms. The site is located in within the village of Sutton on Trent, in the north of district. It is approximately 2.5 km north of the Caledonian Modular, Carlton Works site. The site is within relatively close proximity of the A1 accessed via the B1164 (Great North Road).</p> <p>The site is identified as an Industrial Estate/Existing Employment Policy Area (ref. ST/EA/1) in the adopted Local Plan and the policy seeks to manage the conflict between employment and residential uses. Redevelopment of the site may be constrained by the adjacent railway line and residential dwellings. The site should be protected for employment uses.</p>		

Crew Lane Industrial Area, Southwell (So/E/1) (Ref: NSDC12)

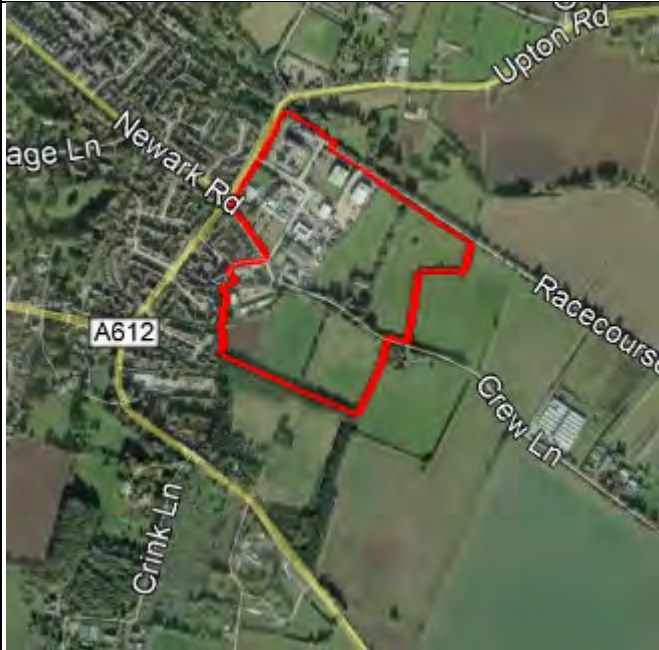

**GROSS SITE AREA:
12.57 ha**

**ESTIMATED NET DEVELOPABLE AREA:
4.65 ha**

(Note: based on the two areas of undeveloped land within the east and south of the site currently allocated for employment uses, namely So/E/2 (2.71ha) and So/E/3 (2.18ha) with a 95% gross to net adjustment applied)

CRITERIA	COMMENT	RATING
<p>Site Context</p> <ul style="list-style-type: none"> • Location with regards to existing employment areas and other sites • How the site fits into the overall portfolio 	<p>This is an existing employment site on the edge of the town of Southwell, approximately 7.7 km west of the Staythorpe Power Station site. The industrial nature of the site is diluted by non-employment uses adjacent to Upton Road. Land to the east and south of the industrial estate is allocated for future expansion.</p>	
<p>Local Plan Designation</p>	<p>The Development Plan for the District comprises of the Amended Core Strategy (adopted 7th March 2019) and Allocations & Development Management (adopted 16 July 2013) Development Plan Document.</p> <p>The site is allocated as an Industrial Estate/Existing Employment Area (So/E/1 – Southwell – Crew Lane Industrial Estate Policy Area) (Allocations & Development Management DPD, 2013) where new employment development will be encouraged.</p> <p>So/E/1 also incorporates two areas of undeveloped land which are currently allocated for employment uses– So/E/2 (2.71ha) and So/E/3 (2.18ha).</p> <p>The Southwell Bypass designation runs through the centre of the site, albeit, it is understood that this bypass is not due to be constructed and therefore the route is no longer protected.</p>	

The site is also contained within the urban boundary/village envelope (DM1) as defined in the Newark & Sherwood Local Development Framework Policies Map.

Figure 1 Newark & Sherwood Policies Map



Source: Newark & Sherwood District Council

The site is included within the 'Southwell Neighbourhood Plan' designated area (2015-2026). Objective 6: Housing and Employment states that *'To support residential and commercial development within the town, through meeting the strategic requirements for growth whilst maximizing the benefits for the community'*.

Immediately to the north of Racecourse Road is Thurgarton Hundred Workhouse Immediate Surrounds Policy So/WH of the Allocations and Development Management DPD which seeks to protect and enhance the setting of the workhouse. Proposals within the Crew Lane Industrial should not negatively impact upon the setting of the workhouse.

Status in SHLAA

Site Ref: Land off Crew Lane (08_0115) (Southwell). Developer has shown interest in the site, developer has invested in the site, there is a number/type of dwellings in mind (detail not provided). Available in 5 years. This area relates to the eastern half of the site, north of Crew Lane, comprising 3.56 ha. Development of the site has potential to impact upon the setting of The Workhouse to the north. Town Council preference for employment/commercial uses on this site. Substantial improvements to infrastructure in Southwell needed to enable site to come forward for residential.

Planning History	<p>Recent planning history includes;</p> <ul style="list-style-type: none"> • 19/02263/FULM - Phased development – 3 new industrial buildings - 0.64ha/6,433 sqm. This is being implemented. • 18/00755/FUL - Convert units 3 & 4 from manufacturing/offices to light industrial and gym - 0.17ha/1744m² 	
Current Use and Land Type	<p>This site is partially brownfield land occupied by an industrial estate and partially undeveloped grassland.</p>	
Occupier Profile (if partly developed, including % of available land and levels of vacancy onsite)	<p>The north-west corner of the site adjacent to Upton Road is occupied by Southwell Court Care Home, south of this there is a BP petrol filling station with M&S Simply Food kiosk. There is also a kennels located within the eastern side of the site.</p> <p>The western half of the site comprises of a number of light industrial units and also Southwell Business Centre. Occupiers include: The House of Cars Southwell Autocentre Oliver Used Cars MJC Motors Energy Manor (manufacturer of pumps) A&V Squires Plant Handicentre DIY store</p> <p>Southwell Business Centre was more modern and occupiers included a personal training studio, healthcare seating provider, a podiatrist, acupuncture clinic, a cake maker, a magazine editors, promotional product supplier and an electrician. At the time of the site visit (December 2020) only one unit was vacant out of the 15 total units.</p> <p>There are two areas of undeveloped land within the east and south of the site which are currently allocated for employment uses – So/E/2 (2.71ha) and So/E/3 (2.18ha).</p>	
Strategic Road Access	<p>The site is 2.7 km from the A617 and 7.4km from the A616. The A1 can be accessed 12.7 km from the site.</p>	<p>Very Poor</p>
Local Road Access	<p>Crew Lane is the site's main access road which travels from the North West off Upton Road through the site. Crew Lane provides reasonable access to the site but then continues through the site to provide access to further properties to the South East and the quality of the road becomes poor.</p> <p>Road access to the A617/A616 is constrained by speed restrictions, winding roads, travel through residential areas and some unmarked roads.</p>	

	<p>The A1 can be accessed via the A616/617.</p> <p>Access to the site is not permitted from Crew Lane Close.</p>	
<p>Proximity to Urban Areas and Access to Labour and Services (including public transport / cycling / walking accessibility)</p>	<p>The site is situated on the Eastern outskirts of the residential town of Southwell which provides schools, a local high street with local shops and amenities and local sports/leisure facilities.</p> <p>A bus stop on Upton Road approximately 0.8 km from the entrance to the site provides regular bus services into the centre of Southwell and onto Nottingham.</p> <p>The site is approximately 3km west of Fiskerton Railway Station and Rolleston Railway Station. Southwell Racecourse is also approximately 3km east of the site.</p>	Average / Good
<p>Compatibility of Adjoining Uses (including amenity impacts experienced by current/future occupiers and neighbouring areas)</p>	<p>The site is bordered by Racecourse Road and the River Greet to the north, agricultural land to the east/south, residential properties to the south and Upton Road to the west with residential properties beyond.</p>	Poor
<p>Developmental and Environmental Constraints (e.g. size; topography; site access; roads, lighting, landscaping, mains utilities and communications infrastructure; flood risk; contamination; nature and heritage conservation)</p>	<p>This is a relatively level site with utilities and communications infrastructure existing within the developed western half of the site.</p> <p>Crew Lane is an unmade road heading east out of the industrial estate. There is a residential property (Home Cottage) and kennel within this area.</p> <p>Overhead lines intersect the site from north to south.</p> <p>The northern half of the site is within Flood Zone 2 and the River Greet is to the north.</p> <p>There are mature trees and hedgerows within the site.</p> <p>It is understood that Asbestos may be present onsite.</p> <p>There is operational gas apparatus within the site boundary.</p> <p>The site is not subject to any listed structures. Beyond Upton Road to the north is Thurgarton Hundred Workhouse (Grade II* Park and Garden) (Historic England Listing Map, 2021).</p>	Poor
<p>Barriers to Delivery and</p>	<p>Crew Lane is an unmade road heading east from</p>	Average

<p>Mitigation (including ownership constraints - if known)</p>	<p>the industrial estate, upgrading of this may be required. Any redevelopment would have to assess and mitigate against flood risk and loss of existing trees. Impact upon the residential property off Crew Lane would need to be considered and upon the Thurgarton Hundred Workhouse to the north.</p> <p>Development will be required to seek to maintain and enhance the current provision of Right of Ways along the eastern boundary of the site.</p> <p>Access to any new development would not be permitted from Crew Lane Close.</p>	
<p>Market Attractiveness (including appropriateness, vacancy and market activity on site for the type of development proposed)</p>	<p>This employment site is conveniently located on the edge of Southwell with good access to local services and labour market. Vacancy levels were low at the time of the site visit with new industrial units under construction. There are two undeveloped areas adjacent to the site which would allow for expansion of the existing industrial uses subject to development of suitable access arrangements.</p>	Good
<p>Strategic Fit with Growth Area Objectives (by target Market Segment)</p>	<p>The site already accommodates key industrial growth sectors as identified in the D2N2 Vision 2030 document including Health/Social Care and Retail. The site has potential to accommodate other key industrial growth sectors albeit it has relatively poor strategic road access.</p>	Average
<p>OVERALL SITE RATING</p>	<p>Average / Poor</p>	
<p>Recommendation and Potential Future Uses</p>	<p>Protect the developed area of So/E/1 for employment uses, amending the boundary to exclude the Southwell Court Care Home and Petrol Filling Station adjacent to Upton Road.</p> <p>Allocate So/E/2 for employment uses (2.71ha).</p> <p>Due to potential access issues it is considered that So/E/3 is more likely to come forward later as part of any Local Plan Review and therefore the Council may wish to consider safeguarding this part of the site for employment uses, with potential future scope for an element of mixed-use development.</p>	
<p>SITE SUMMARY:</p>		
<p>This is an existing employment site (So/E/1 – Southwell – Crew Lane Industrial Estate Policy Area) on the edge of the town of Southwell. Vacancy levels were low at the time of the site visit and new industrial units were under construction. The industrial nature of the site is diluted by non-employment uses adjacent to Upton Road. Land to the east and south of the industrial estate is currently allocated for future expansion (So/E/2 and So/E/3). It is recommended that the developed area of So/E/1 is protected for employment uses with the boundary amended to exclude the non-employment uses adjacent to Upton Road. So/E/2 should be allocated for</p>		

employment uses. So/E/3 should be safeguarded for future employment uses, with potential for mixed-use development.

Boughton Industrial Estate North (OB/E/1) (Ref: NSDC13)



**GROSS SITE AREA:
25.49 ha**

**ESTIMATED NET DEVELOPABLE AREA:
1.2 ha**

CRITERIA	COMMENT	RATING
-----------------	----------------	---------------

Site Context

- Location with regards to existing employment areas and other sites
- How the site fits into the overall portfolio

This site is occupied by the northern portion of the Boughton Industrial Estate. This is a large site accommodating an extensive complex of Nissen Huts of curved corrugated sheet construction, as well as some modern small industrial units. The site is 200m west of the Kirton Brickworks Site.

Local Plan Designation

The Development Plan for the District comprises of the Amended Core Strategy (adopted 7th March 2019) and Allocations & Development Management (adopted 16 July 2013) Development Plan Document. The site is within an Industrial Estate / Existing Employment Policy Area (OB/E/1 – Ollerton & Boughton – Boughton Industrial Estate (North) Policy Area 1) (Allocations & Development Management DPD, 2013 – see extract below).

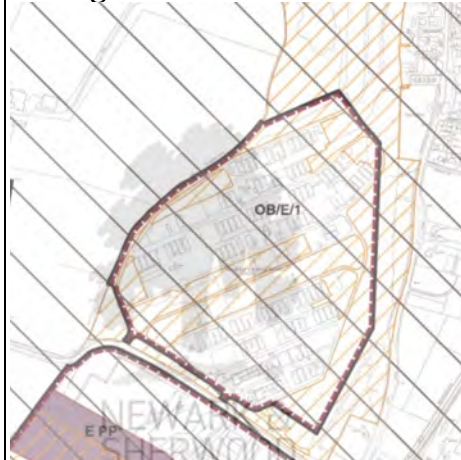

The site also falls within a Source Protection Zone 3 (DM10) and a Site of Interest in Nature Conservation (Core Policy 12 and DM7).

Beyond the A6075 to the south is a second employment site

	<p>– OB/E/2 – Boughton Industrial Estate (South) Policy Area 2 (Allocations & Development Management DPD, 2013).</p> <p>The site is also contained within the urban boundary/village envelope (DM1) as defined in the Newark & Sherwood Local Development Framework Policies Map.</p>	
Status in SHLAA	N/A	
Planning History	<p>Recent planning history includes:</p> <ul style="list-style-type: none"> • 15/00391/FULM - Development and Operation of a Plant Training and Testing Centre including erection of offices, training room, welfare facilities, secure compound and ancillary development - 1.24 ha/12,389 sqm 	
Current Use and Land Type	This is a brownfield site occupied by an industrial estate.	
Occupier Profile (if partly developed, including % of available land and levels of vacancy onsite)	<p>The site is fully developed and accommodates an extensive complex of Nissen Huts of curved corrugated sheet construction, many of which are in poor condition, as well as some modern small industrial units in good condition.</p> <p>Occupiers include: Jordan Aggregates (construction) Plant Testing LTD (plant and machinery training centre) Arable Services LTD (agricultural contractors) The Furniture Project (charity) Merlins MOT Kingsmill Concrete Products Town & Country Grounds Maintenance Key Building Supplies</p> <p>There is also a Flexspace Business Centre, a modern business centre providing small offices, workshops and studios. There are also areas of open-air storage onsite.</p> <p>Vacancy levels appeared to be low at the time of the site visit (December 2020). There was an undeveloped plot within the centre of the site of approximately 1.2 ha.</p>	
Strategic Road Access	<p>The A6075 (Cocking Hill) runs adjacent to the site. The A614 can be accessed approximately 3.6km west of the site and the A1 can be accessed approximately 7.7km from the site via the A6075 and Ashvale Road.</p>	Average / Poor
Local Road Access	<p>There are two access roads onto the site off the A6075 (Cocking Hill). The A6075 is a good free-moving road but is constrained by residential areas, both to the North East towards the A1 and to the West where it passes through a number of residential towns. There are 2 height-restricted railway bridges less than 1km from the site - 0.3km from the entrance to the site to the South</p>	Average

	East on Cocking Hill (max height 4.5m) and on the A6075 0.8km from the site to the West (max height 4.6m).	
Proximity to Urban Areas and Access to Labour and Services (including public transport / cycling / walking accessibility)	<p>The site is approximately 1.5 km from the residential village of Boughton and 2.5 km from the larger residential town of Ollerton/New Ollerton to the West. Boughton provides a school and local shops/amenities; Ollerton provides further schools and a wider range of shops and amenities including a medical centre and police station.</p> <p>The small residential village of Kirton lies to the North of the site but provides no local amenities.</p> <p>Bus stops just outside the entrance to the site on Cocking Hill provide regular bus services to Kirton (and less regular services to Retford) to the North and hourly buses to Mansfield via Boughton and Ollerton to the West/South West.</p>	Average / Poor
Compatibility of Adjoining Uses (including amenity impacts experienced by current/future occupiers and neighbouring areas)	The site is bordered by mature trees with greenfield land beyond with the A6075 running along the South and East of the site. Further industrial/retail units are situated beyond the A6075 to the South. Boughton Dyke follows along the edge of the site to the West/North West.	Very Good
Developmental and Environmental Constraints (e.g. size; topography; site access; roads, lighting, landscaping, mains utilities and communications infrastructure; flood risk; contamination; nature and heritage conservation)	<p>This is relatively level, existing employment site with utilities and communications infrastructure in place. The site access is an un-adopted highway and some of the roads within the site are unmade.</p> <p>A review of Flood Maps for Planning (Gov.uk, 2021) shows the site is not located within a Flood Zone however the site does border the Boughton Dyke to the west. The dyke is designated as a Flood Zone 3.</p> <p>The site is not subject to any listed structures nor are there any located in the immediate vicinity (Historic England Listing Map, 2021).</p> <p>There are some protected trees and areas identified as Sites of Interest in Nature Conservation within the site.</p>	Average
Barriers to Delivery and Mitigation (including ownership constraints - if known)	<p>Any redevelopment of the site would need to be mindful of impact upon the protected trees and sites of Interest in Nature Conservation within the site and mitigate any impact accordingly.</p> <p>Development proposals within and with the potential to impact on the Groundwater Source Protection</p>	Average / Good

	Zone, should address the potential risk through mitigation as part of the development or through off site measures where necessary.	
Market Attractiveness (including appropriateness, vacancy and market activity on site for the type of development proposed)	This is a large employment site accommodating a wide range of businesses, with limited vacancies at the time of the site visit (December 2020). However, the site would benefit from investment in the road infrastructure and the employment units.	Good
Strategic Fit with Growth Area Objectives (by target Market Segment)	The site already accommodates key industrial growth sectors as identified in the D2N2 Vision 2030 document including construction.	Average
OVERALL SITE RATING	Average	
Recommendation and Potential Future Uses	Allocate for employment uses (i.e. retain protection for employment uses (OB/E/1 – Ollerton & Boughton – Boughton Industrial Estate (North) Policy Area 1) (Allocations & Development Management DPD, 2013))	
SITE SUMMARY:		
<p>This site is occupied by the northern portion of the Boughton Industrial Estate, it is a large site accommodating an extensive complex of Nissen Huts of curved corrugated sheet construction, as well as some modern small industrial units. The site is 200m west of the Kirton Brickworks Site. The site would benefit from investment in the road infrastructure and the employment units albeit vacancy levels appeared to be low at the time of the site visit (December 2020). There was an undeveloped plot within the centre of the site of approximately 1.2 ha. The site is located within an Industrial Estate/Existing Employment Policy Area (OB/E/1 – Ollerton & Boughton – Boughton Industrial Estate (North) Policy Area 1) in the Local Plan and it is recommended that the site is allocated for employment uses.</p>		

Boughton Industrial Estate South (OB/E/2) (Ref: NSDC14)



**GROSS SITE AREA:
31.46 ha**

**ESTIMATED NET DEVELOPABLE AREA:
3.59 ha**
(Note: comprising of the OB/E/3 allocation with a 95% gross to net adjustment)

CRITERIA

COMMENT

RATING

Site Context

- Location with regards to existing employment areas and other sites
- How the site fits into the overall portfolio

This site is occupied by the southern portion of the Boughton Industrial Estate, it is a large site accommodating a range of businesses primarily logistics, construction and transport equipment manufacturing. The site is 200m west of the Kirton Brickworks Site.

Local Plan Designation

The Development Plan for the District comprises of the Amended Core Strategy (adopted 7th March 2019) and Allocations & Development Management (adopted 16 July 2013) Development Plan Document. The site is located within an Industrial Estate/Existing Employment Policy Area (OB/E/2 – Ollerton & Boughton – Boughton Industrial Estate (South) Policy Area 2 (Allocations & Development Management DPD, 2013 – see extract below).



Within the south of the site, there is an area of undeveloped land allocated for employment (OB/E/3 – Ollerton &

	<p>Boughton – Employment Site 1) (Allocations & Development Management DPD, 2013). Within the north of the site there is an area identified as having planning permission for employment uses (E PP) (Allocations & Development Management DPD, 2013).</p> <p>The site also falls within a Source Protection Zone 3 (DM10) and a Site of Interest in Nature Conservation (Core Policy 12 and DM7).</p> <p>Beyond the A6075 to the north is a second employment site – OB/E/1 – Boughton Industrial Estate (North) Policy Area 1 (Allocations & Development Management DPD, 2013).</p> <p>The site is also contained within the urban boundary/village envelope (DM1) as defined in the Newark & Sherwood Local Development Framework Policies Map.</p>
Status in SHLAA	N/A
Planning History	<p>Recent planning history includes:</p> <ul style="list-style-type: none"> • 18/00542/FUL - 6 industrial units - 0.39ha/3920m2 • 11/00768/FULM - Erection of an extension to B8 warehouse building - 13,000m2
Current Use and Land Type	This is a primarily brownfield site occupied by an industrial estate, although there are undeveloped grassland sites within the western half of the site.
Occupier Profile (if partly developed, including % of available land and levels of vacancy onsite)	<p>The site accommodates a range of businesses including:</p> <p>Clipper logistics Boughton Sawmills S&E Timber Supplies Munson Transport Limited AB Conveyors A1 Flue Systems Plasmor (concrete product supplier) Carwood (vehicle parts remanufacturing and repair) Weonlymot.co.uk</p> <p>At the time of the site visit (December 2020) the former Rollins steel fabrication workshop was on the market (0.55 ha plot).</p> <p>The site identified within the Allocations & Development Management DPD as having permission for employment (E PP) is within the Clipper Logistics site and has been partially developed for an extension to the B8 warehousing (11/00768/FULM). The remainder of this site is reserved for future expansion of Clipper Logistics.</p> <p>The employment designation (OB/E/3) within the south of the site remains undeveloped and comprises of 3.78 ha.</p>
Strategic Road Access	The A6075 (Cocking Hill) runs adjacent to the site. Average /

	The A614 can be accessed approximately 3.6km west of the site and the A1 can be accessed approximately 7.7km from the site via the A6075 and Ashvale Road.	Poor
Local Road Access	There are two access roads onto the site off the A6075 (Cocking Hill). The A6075 is a good free-moving road but is constrained by residential areas, both to the North East towards the A1 and to the West where it passes through a number of residential towns. There are 2 height-restricted railway bridges less than 1km from the site - 0.3km from the entrance to the site to the South East on Cocking Hill (max height 4.5m) and on the A6075 0.8km from the site to the West (max height 4.6m).	Average
Proximity to Urban Areas and Access to Labour and Services (including public transport / cycling / walking accessibility)	<p>The site is approximately 1.5km from the residential village of Boughton and 2.5km from the larger residential town of Ollerton/New Ollerton to the West. Boughton provides a school and local shops/amenities, Ollerton provides further schools and a wider range of shops and amenities including a medical centre and police station.</p> <p>The small residential village of Kirton lies approximately 1.1km to the North of the site but provides no local amenities.</p> <p>Bus stops just outside the entrance to the site on Cocking Hill provide regular bus services to Kirton (and less regular services to Retford) to the North and hourly buses to Mansfield via Boughton and Ollerton to the West/South West.</p>	Average / Poor
Compatibility of Adjoining Uses (including amenity impacts experienced by current/future occupiers and neighbouring areas)	The site is bordered by mature trees with greenfield land beyond and the A6075 running along the North of the site. Further industrial/retail units are situated beyond the A6075 to the North and a sewage works is situated towards the West. A railway line runs along the South East border of the site.	Very Good
Developmental and Environmental Constraints (e.g. size; topography; site access; roads, lighting, landscaping, mains utilities and communications infrastructure; flood risk; contamination; nature and heritage conservation)	<p>This is relatively level, existing employment site with utilities and communications infrastructure in place. The site access is an un-adopted highway and some of the roads within the site are unmade.</p> <p>A review of Flood Maps for Planning (Gov.uk, 2021) shows the site is not located within a flood zone. However, the site borders Boughton Dyke to the west. The dyke is designated as a Flood Zone 3.</p> <p>The site is not subject to any listed structures nor are there any located within the immediate locality (Historic England Listing Map, 2021).</p>	Average

	<p>There are protected trees within close proximity, the site is in close proximity to Wellow Park SSSI and was formerly identified as a SINC.</p> <p>Potential contamination from former railway land to the south.</p>	
<p>Barriers to Delivery and Mitigation (including ownership constraints - if known)</p>	<p>Development proposals within and with the potential to impact on the Groundwater Source Protection Zone, should address the potential risk through mitigation as part of the development or through off site measures where necessary.</p> <p>Any redevelopment of the site would need to assess the impact upon the sites of Interest in Nature Conservation within the site and mitigate any impact. Potential contamination may require mitigation.</p>	Average / Good
<p>Market Attractiveness (including appropriateness, vacancy and market activity on site for the type of development proposed)</p>	<p>This is a large employment site accommodating a wide range of businesses, with limited vacancies at the time of the site visit (December 2020). However, it would benefit from investment in the road infrastructure and the employment units.</p>	Good
<p>Strategic Fit with Growth Area Objectives (by target Market Segment)</p>	<p>The site already accommodates key industrial growth sectors as identified in the D2N2 Vision 2030 document including logistics, transport equipment manufacturing and construction.</p>	Average
<p>OVERALL SITE RATING</p>	<p>Average</p>	
<p>Recommendation and Potential Future Uses</p>	<p>Allocate for employment uses (i.e. retain existing employment protection OB/E/2 and OB/E/3)</p>	
<p>SITE SUMMARY:</p> <p>This site is occupied by the southern portion of the Boughton Industrial Estate, it is a large site accommodating a range of businesses primarily logistics, construction and transport equipment manufacturing. The site is 200m west of the Kirton Brickworks Site. The site would benefit from investment in the road infrastructure and the employment units.</p> <p>The site identified in the Allocations & Development Management DPD (2013) as having planning permission for employment uses (E PP) within the north of the site is within the Clipper Logistics site and has been partially developed, with the remainder reserved for future expansion. The employment designation (OB/E/3) within the south of the site remains undeveloped and comprises of 3.78 ha. The site is protected as an Industrial Estate/Existing Employment Policy Area (OB/E/2 – Ollerton & Boughton – Boughton Industrial Estate (South) Policy Area 2) and the undeveloped site to the south is designated for employment protection (OB/E/3) in the Local Plan, it is recommended that this site is allocated for employment uses.</p>		

Sherwood Energy Village (Ref: NSDC15)



**GROSS SITE AREA:
10.68 ha**

**ESTIMATED NET DEVELOPABLE AREA:
2 ha**

(Note: based upon the two sites within the western site c. 0.9ha and c.1.1ha which were previously identified as having planning permission for employment in the Allocations & Development Management DPD).

CRITERIA	COMMENT	RATING
<p>Site Context</p> <ul style="list-style-type: none"> • Location with regards to existing employment areas and other sites • How the site fits into the overall portfolio 	<p>This is the site of the former Ollerton Colliery. The colliery closed in 1994 and the site is being redeveloped into The Sherwood Energy Village, an environmentally friendly business park.</p> <p>The site is immediately north-west of the Murphy Pipelines site. It is also 2.7 km to the east of the Thoresby Colliery site and 3km to the west of the Boughton Industrial Estate and Kirton Brickworks.</p>	
<p>Local Plan Designation</p>	<p>The Development Plan for the District comprises of the Amended Core Strategy (adopted 7th March 2019) and Allocations & Development Management (adopted 16 July 2013) Development Plan Document.</p> <p>The sites are identified in the Newark & Sherwood Local Development Framework Policies Map as follows:</p>	

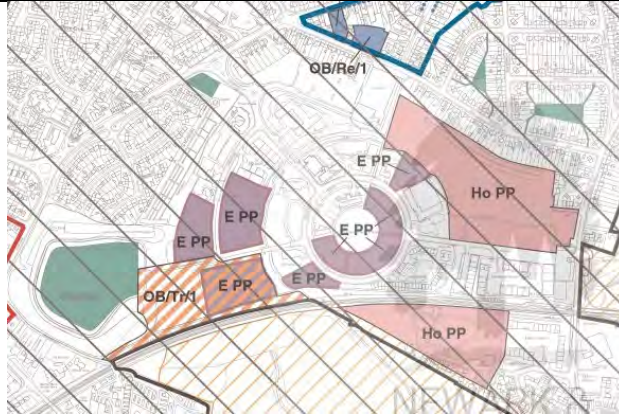

- The eastern site is identified as a Housing Site with Planning Permission (Ho PP) (April 2011);
- The central teardrop shaped sites are unallocated;
- The small site to the west of the central teardrop shaped sites is identified as a site with Planning Permission for Employment (E PP) (April 2011); and
- The western site comprises of sites with planning permission for employment uses (E PP) (April 2011) in the northern and eastern portions; a Transport Allocation (OB/Tr/1 – Ollerton & Boughton – Transport Allocation 1, Allocations & Development Management DPD, 2013) within the south of the site adjacent to the disused railway line; and a site for Public Open Space/School Playing Fields (protected by Spatial Policy 8) to the west of the site by Back Lane. The transport allocation relates to a general area of search for a new station and car park to allow for the potential reopening of the Dukeries railway line. Development on or around this site will not be permitted where it would prejudice this scheme coming forward.

The site also falls within a Source Protection Zone (DM10), with two respective area designated as a Site of Interest in Nature Conservation (Core Policy 12 and DM7) to the south and east of the site.

To the south of the sites centre is another site identified as having planning permission for housing (Ho PP) (April 2011) with an area allocated for retail to the immediate north of the site (OB/Re/1 and OB/Re/2 – Ollerton & Boughton – Retail Allocation 1 and 2, Allocations & Development Management DPD, 2013).

The site is also contained within the urban boundary/village envelope (DM1) as defined in the Newark & Sherwood Local Development Framework Policies Map.

Status in SHLAA

N/A

Planning History

- 16/00902/FULM - Construction of 24 two bedroom apartments and 27 three bedroom houses. **(Note: this relates to the small site to the west of the central teardrop shaped sites. The permission has been**

	<p>implemented).</p> <ul style="list-style-type: none"> • 05/02273/FULM - Erection of 134 No. houses, 23 No. bungalows & 27 No. apartments (Resubmission). Applications were also submitted to discharge conditions in 2014 and then an EIA screening request in 2015 - 15/SCR/00015 Proposed Residential Development (Note: these applications relate to the eastern site, albeit the site remains undeveloped). • 05/00297/FULM - New offices and storage unit. (Note: this relates to an area within the western site, albeit it has not been implemented). • 01/00942/FUL - Proposed new access road and associated infrastructure to serve proposed development • 01/00875/OUT - Sherwood Energy Village (mix of industry, commerce, housing, recreation, education and associated works) 	
Current Use and Land Type	<p>This is a former colliery site, now a partially complete business park. The eastern and western sites are undeveloped grassland. The central teardrop shaped sites comprise of a play area, sports courts and recreational space within the Central Park area and the small site immediately to the west has been developed for residential apartments.</p>	
Occupier Profile (if partly developed, including % of available land and levels of vacancy onsite)	<p>The eastern and western sites are undeveloped grassland. The central teardrop shaped sites comprise of a play area, sports courts and recreational space within the Central Park area and the small site immediately to the west has been developed for residential apartments.</p> <p>Occupiers on the wider Sherwood Energy Village site include a Tesco Superstore and petrol filling station, Centre Parcs Head Office, Nottinghamshire County Council, Pathfinders Care, Linden Management Training Centre, Experian credit reporting agency, Independent Civils Solutions (building materials supplier) and a nursery. There are also residential uses within the central circle, with Central Park play area in the middle.</p> <p>Vacancy levels on the wider site appeared to be low at the time of the site visit (December 2020).</p>	
Strategic Road Access	<p>The A6075 (Forest Road) runs adjacent to the site as a whole to the North West. The A614 is approximately 1.5 km west of the site via the A6075. The A1 can be accessed approximately 10.6km from the site via the A6075 and Ashvale Road.</p>	Average / Poor
Local Road Access	<p>The site as a whole is accessed via Edison Rise of the A6075 (Forest Road). The A6075 is a good free-moving road but is constrained by residential areas,</p>	Average

	<p>both to the North East towards the A1 and to the West where it passes through a number of residential towns.</p> <p>There is a height-restricted railway bridge (max height 4.6m). 1.7km from the site on the A6075 (Tuxford Road) traveling East towards the A1.</p> <p>The eastern site can be accessed via Culpepper Avenue from Newark Road to the east and access could be created from the spine road heading east off Darwin Drive. The central teardrop shaped sites do not have vehicular access, access is via footpath only. The small residential site to the west is accessed from Darwin Drive and the western site could be accessed from a stub-road off Darwin Drive.</p>	
<p>Proximity to Urban Areas and Access to Labour and Services (including public transport / cycling / walking accessibility)</p>	<p>The site is on the Southern outskirts of the residential town of Ollerton/New Ollerton. Ollerton provides schools and a range of shops including supermarkets and amenities including a medical centre and police station – many are within (0.5km) walking distance of the site entrance.</p> <p>Bus stops just outside the entrance to the site on Forest Road provide regular bus services to Walesby and Kirton to the North East and half-hourly buses to Mansfield (and less regular services to Nottingham) to the South West. There is also a bus stop within the centre circle of the site.</p>	Good
<p>Compatibility of Adjoining Uses (including amenity impacts experienced by current/future occupiers and neighbouring areas)</p>	<p>The highlighted areas above are part of an established office/industrial park.</p> <p>The larger site to the West is bordered by mature trees to the West with the A616 and some residential areas beyond. There are further residential areas and a cemetery to the North and the larger office/industrial park continues to the East. A disused railway line travels along the Southern edge of the site with greenfield land beyond.</p> <p>The larger site to the East is bordered by residential areas to the North and East and the larger office/industrial park continues to the South and West.</p> <p>The smaller sites are within the centre of the larger office/industrial park along with established office and residential buildings.</p>	Average
<p>Developmental and Environmental Constraints (e.g. size; topography; site access; roads, lighting, landscaping, mains)</p>	<p>The majority of the site is relatively level, albeit the western site rises a few metres to the west before reaching a plateau. There are some trees and hedgerows on the site.</p>	Very Good

<p>utilities and communications infrastructure; flood risk; contamination; nature and heritage conservation)</p>	<p>A review of Flood Maps for Planning (Gov.uk, 2021) shows the site is not located within a flood zone.</p> <p>The site is not subject to any listed structures nor are there any within the immediate locality (Historic England Listing Map, 2021).</p>	
<p>Barriers to Delivery and Mitigation (including ownership constraints - if known)</p>	<p>Close proximity to residential properties and the disused railway to the south. The central tear-drop sites are within the Central Park area and the small site to the west of this has been developed for residential apartments, and therefore are not available for redevelopment. No other barriers to redevelopment were evident from the site visit.</p>	<p>Very Good</p>
<p>Market Attractiveness (including appropriateness, vacancy and market activity on site for the type of development proposed)</p>	<p>The sites are within the partially-developed Sherwood Energy Village, which accommodates some key employers for the district and is in an accessible location within close proximity to the labour market and services within Ollerton and New Ollerton. The buildings are modern purpose-built units and the environmental quality is good. The smaller sites in the centre are not available for redevelopment.</p> <p>The eastern site is likely to come forward for residential uses given the historic permissions on the site. Areas within the western site would be more suitable for employment uses with the remainder of the site is allocated as public open space and protected for transport schemes.</p>	<p>Very Good</p>
<p>Strategic Fit with Growth Area Objectives (by target Market Segment)</p>	<p>The wider Sherwood Energy Village site already accommodates key industrial growth sectors as identified in the D2N2 Vision 2030 document including Health/Social Care, Professional/Business Service, Construction and Retail. The site has potential to accommodate other key industrial growth sectors.</p>	<p>Very Good</p>
<p>OVERALL SITE RATING</p>	<p>Very Good</p>	
<p>Recommendation and Potential Future Uses</p>	<p>Allocate for employment uses as per the below.</p> <p>Allocate sites identified in the Allocations & Development Management DPD (2013) as having planning permission for employment (E PP) within the western site for employment uses; retain the eastern site identified as having planning permission for residential (Ho PP) for residential uses; and protect the recreational space on the central teardrop shaped sites. The small site to west of the central sites should not be allocated, given it has been developed for residential apartments.</p>	

To the north of the site, the former Experian offices have been redeveloped for residential. The Sherwood Energy Village was intended to be developed as a business park and further residential development would dilute the employment uses here. It is recommended that the impact of this type of change is assessed in order to understand whether further such loss would be undesirable and therefore should be prevented.

SITE SUMMARY:

This is site of the former Ollerton Colliery. The colliery closed in 1994 and the site is being redeveloped into The Sherwood Energy Village, an environmentally friendly business park. The site is immediately north-west of the Murphy Pipelines site. It is also 2.7km to the east of the Thoresby Colliery site and 3km to the west of the Boughton Industrial Estate and Kirton Brickworks. Occupiers on the wider Sherwood Energy Village site include a Tesco Superstore and petrol filling station, Centre Parcs Head Office, Nottinghamshire County Council, a nursery, residential properties and Central Park play area in the middle.

The eastern site is identified in the Allocations & Development Management DPD (2013) as a site with planning permission for residential (Ho PP) and has historical permissions for residential development, albeit it remains undeveloped. The central teardrop shaped sites comprise of a play area, sports courts and recreational space within the Central Park area and are unallocated. The small site to the west of the central teardrop shaped sites was identified in the Allocations & Development Management DPD (2013) as having planning permission for employment (E PP) but has since been developed for residential apartments. The western site comprises of undeveloped grassland and is allocated in the Local Plan as follows: a Transport Allocation (OB/Tr/1 – Ollerton & Boughton – Transport Allocation 1, Allocations & Development Management DPD, 2013) within the south of the site adjacent to the disused railway line; and a site for Public Open Space/School Playing Fields (protected by Spatial Policy 8) to the west of the site by Back Lane. There are also two sites within the northern and eastern areas of the western site which were identified as having planning permission for employment in the Allocations & Development Management DPD (2013) and remain undeveloped.

It is recommended that the sites identified in the Allocations & Development Management DPD (2013) as having planning permission for employment (E PP) within the western site are allocated for employment uses; the eastern site identified as having planning permission for residential (Ho PP) should be retained for residential uses; and the recreational space on the central teardrop shaped sites should be protected. The small site to west of the central sites should not be allocated, given it has been developed for residential apartments.

Murphy Pipelines Ltd, Newark Road (Ref: NSDC16)



**GROSS SITE AREA:
7.41 ha**

**ESTIMATED NET DEVELOPABLE AREA:
0 ha**

CRITERIA	COMMENT	RATING
<p>Site Context</p> <ul style="list-style-type: none"> • Location with regards to existing employment areas and other sites • How the site fits into the overall portfolio 	<p>The site is occupied by J. Murphy & Sons Ltd, a global, specialist engineering and construction company. It is immediately south-east of the Sherwood Energy Village and 4km to the east of the Thoresby Colliery site and 2.3km to the west of the Boughton Industrial Estate and Kirton Brickworks.</p>	
<p>Local Plan Designation</p>	<p>The Development Plan for the District comprises of the Amended Core Strategy (adopted 7th March 2019) and Allocations & Development Management (adopted 16 July 2013) Development Plan Document.</p> <p>The site is unallocated.</p> <p>Murphy Pipeline Ltd. is enveloped by a Site of Nature Conservation (Core Policy 12 and DM7) and is located within a Source Protection Zone 3 (DM10).</p> <p>Further to the south and beyond the sites borders is a Conservation Area (Core Policy 14 and DM8) and land designated as a Main Open Area within the Newark & Sherwood Local Development Framework Policies Map. A Housing Site with Planning Permission (April 2011) is located to the west of the site, past Newark Road.</p> <p>The site is also contained within the urban boundary/village envelope (DM1) on the designations edge, within the Newark & Sherwood Local Development Framework Policies Map.</p>	
<p>Status in SHLAA</p>	<p>Site Ref: Newark Road (08_0569) (Ollerton & Boughton) for a proposed yield of 149 dwellings. The site is economically</p>	

	viable/achievable for housing and could be available in 10-15 years' time.	
Planning History	Recent planning history includes: <ul style="list-style-type: none"> 18/02090/FUL - Replacement of temporary structures and erection of a two-storey building in existing yard - 1.02 ha/10,191 sqm 	
Current Use and Land Type	This is a brownfield site in employment use.	
Occupier Profile (if partly developed, including % of available land and levels of vacancy onsite)	The site is occupied by J. Murphy & Sons Ltd, a global specialist engineering and construction company.	
Strategic Road Access	The A616 is accessed approximately 0.8 km from the site entrance with the A1 approximately 15km from the site via the A616 and Ossington Road.	Average / Poor
Local Road Access	The entrance to the site is via Newark Road which joins the A6075 to the North and the A616 to the South. Newark Road travels through residential areas and is further constrained by a height-restricted bridge (max height 4.2m) approximately 0.1 km from the site entrance to the North	Average
Proximity to Urban Areas and Access to Labour and Services (including public transport / cycling / walking accessibility)	The site is approximately 1.5km from the centre of the residential town of Ollerton/New Ollerton. Ollerton provides schools and a range of shops including supermarkets and amenities including a medical centre and police station. The nearest bus stop is 0.8km north of the site on the A6075 (Tuxford Road) which provide regular bus services to Walesby and Kirton to the north east and half-hourly buses to Mansfield (and less regular services to Nottingham) to the south west.	Average
Compatibility of Adjoining Uses (including amenity impacts experienced by current/future occupiers and neighbouring areas)	The site is bordered by Newark Road to the West with a further industrial site beyond and the site also surrounds a residential area to the West. A crematorium borders the site to the South West with greenfield land to the North, South and East. A disused railway line travels across the top of the Northern border of the site.	Average / Poor
Developmental and Environmental Constraints (e.g. size; topography; site access; roads, lighting, landscaping, mains utilities and communications)	This is an existing employment site with utilities and communications infrastructure in place. A review of Flood Maps for Planning (Gov.uk, 2021) shows the site is not located within a flood	Very Good

infrastructure; flood risk; contamination; nature and heritage conservation)	<p>zone.</p> <p>The site is not subject to any listed structures nor are there any within the immediate vicinity (Historic England Listing Map, 2021).</p> <p>The site is bound by a Site of Nature Conservation.</p>	
Barriers to Delivery and Mitigation (including ownership constraints - if known)	In terms of redevelopment, the following neighbouring uses may pose a constraint/require mitigation, as the site is adjacent to a crematorium, wraps around a residential area, a disused railway line is adjacent to the northern boundary and protected open space bounds the site to the north, east and south.	Poor
Market Attractiveness (including appropriateness, vacancy and market activity on site for the type of development proposed)	The site accommodates an important local employer within a global business and is fully occupied.	Good
Strategic Fit with Growth Area Objectives (by target Market Segment)	The site already accommodates key industrial growth sectors as identified in the D2N2 Vision 2030 document including construction.	Good
OVERALL SITE RATING	Average	
Recommendation and Potential Future Uses	Protect for employment uses	
SITE SUMMARY:		
<p>The site is occupied by J. Murphy & Sons Ltd, a global, specialist engineering and construction company and an important local employer. It is immediately south-east of the Sherwood Energy Village and 4km to the east of the Thoresby Colliery site and 2.3 km to the west of the Boughton Industrial Estate and Kirton Brickworks. Any future redevelopment of the site may be constrained by the adjoining uses - the site is adjacent to a crematorium, wraps around a residential area, a disused railway line is adjacent to the northern boundary and protected open space bounds the site to the north, east and south. The site is unallocated within the Local Development Framework and it is recommended that it is protected for employment uses going forward.</p>		

Kirton Brick Works, Main Street (Ref: NSDC17)



**GROSS SITE AREA:
86.17 ha**

**ESTIMATED NET DEVELOPABLE AREA:
0 ha**

CRITERIA	COMMENT	RATING
<p>Site Context</p> <ul style="list-style-type: none"> • Location with regards to existing employment areas and other sites • How the site fits into the overall portfolio 	<p>The site is occupied by Kirton Brickworks and clay pit, operated by Forterra – one of the largest manufacturers of building products in the UK. The site is 200m east of the Boughton Industrial Estate.</p>	
<p>Local Plan Designation</p>	<p>The Development Plan for the District comprises of the Amended Core Strategy (adopted 7th March 2019) and Allocations & Development Management (adopted 16 July 2013) Development Plan Document.</p> <p>The majority of the Kirton Brick Works site is not subject to any planning policy designation (Newark & Sherwood Local Development Framework Policies Map).</p>  <p>However, the site is allocated as land with planning permission to extract minerals and 15 ha of land to the north of Kirton Brickworks (between the railway line and Kirton Road) are allocated as a proposed area for future mineral working (clay extraction) (Policy M11.1 Kirton Allocation, see image above) in the Adopted Nottinghamshire Minerals Local Plan (2005). This is now being updated by a new minerals plan. The site is designated as a permitted site for the</p>	

extraction of brick clay (MP6a – Kirton) in the Publication Version Nottinghamshire Minerals Local Plan (2019), the plan is currently undergoing public examination.

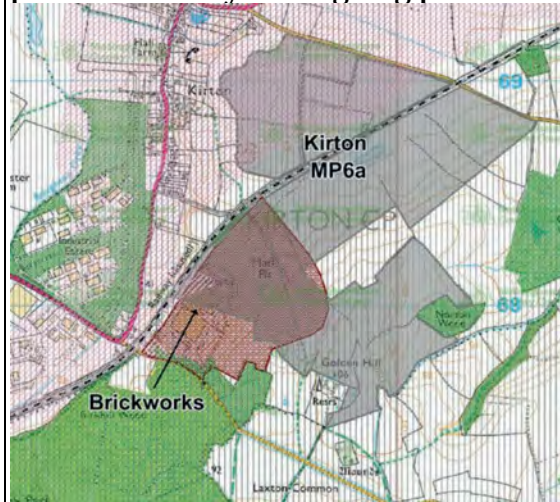

The western half of the site is located within a Source Protection Zone 3 (DM10) and includes several patches of land designated as a Site of Interest in Nature Conservation (Core Policy 12 and DM7) with a Regionally Important Geology Site (Core Policy 12) towards the centre of the site.

The Brickworks itself is designated as a hazardous installation (DM10).

Bordering the site to the south-east is a Site of Interest in Nature Conservation (Core Policy 12 and DM7) containing an Ancient Woodland (Core Policy 12 and DM7).

Status in SHLAA

N/A

Planning History

Recent planning applications:

17/00897/CMM - Winning and working of clay, shales, mudstones, sandstones and siltstones comprising a western extension to the existing Kirton north quarry workings. Restoration to open water, woodland and grassland. Retention of temporary railway bridge crossing and haul road. Clay and soil stockpiling and variation to the restoration of Kirton North.

17/01851/CMASCO - Winning and working of clay, shales, mudstones, sandstones and siltstones comprising a western extension to the existing Kirton north quarry workings. Restoration to open water, woodland and grassland. Retention of temporary railway bridge crossing and haul road. Clay and soil stockpiling and variation to the restoration of Kirton North.

16/01393/CMASCO - Proposed western extension

Current Use and Land Type

This is a brownfield site in use as a brickworks and clay pit. The current workings at Kirton brickworks are being

	progressively restored back to their previous agricultural use, by reprofiling the hillside from which the clay has been extracted.	
Occupier Profile (if partly developed, including % of available land and levels of vacancy onsite)	The site is occupied by Kirton Brickworks and clay pit, operated by Forterra – one of the largest manufacturers of building products in the UK. The site incorporates the brickworks itself and land used for the extraction of clay.	
Strategic Road Access	The A6075 (Cocking Hill) is less than 0.2 km from the entrance to the site. The A1 can be accessed approximately 7.6km from the site via the A6075 and Ashvale Road.	Average / Poor
Local Road Access	<p>There is one access road onto the site via Cocking Hill, approximately 0.2km before Cocking Hill meets the A6075.</p> <p>Cocking Hill to the South of the A6075 becomes Acre Edge Road, a rural two-lane road which continues East towards the village of Laxton.</p> <p>The A6075 is a good free-moving road but is constrained by residential areas, both to the North East towards the A1 and to the West where it passes through a number of residential towns. There are 2 height-restricted railway bridges less than 1.5km from the site – less than 0.1km from the entrance to the site to the West on Cocking Hill (max height 4.5m) and on the A6075 1.4km from the site to the West (max height 4.6m).</p>	Average
Proximity to Urban Areas and Access to Labour and Services (including public transport / cycling / walking accessibility)	<p>The site is approximately 2.4km from the residential village of Broughton and 2.7km from the larger residential town of Ollerton/New Ollerton to the West. Broughton provides a school and local shops/amenities, Ollerton provides further schools and a wider range of shops and amenities including a medical centre and police station.</p> <p>The small residential village of Kirton lies less than 1km to the North of the site but provides no local amenities.</p> <p>Bus stops on Cocking Hill approximately 0.5km from the entrance to the site provide regular bus services to Kirton (and less regular services to Retford) to the North and hourly buses to Mansfield via Broughton and Ollerton to the West/South West.</p>	Average / Poor
Compatibility of Adjoining Uses (including amenity impacts experienced by current/future)	The site is bordered by Cocking Hill and a residential property to the South and Kirton Road to the North. The majority of the site adjoins	Very Good

occupiers and neighbouring areas)	greenfield land. A railway line runs along the Western border of the bottom of site then continues through to dissect the top of the site.	
Developmental and Environmental Constraints (e.g. size; topography; site access; roads, lighting, landscaping, mains utilities and communications infrastructure; flood risk; contamination; nature and heritage conservation)	<p>This is a large gently undulating site with a railway line intersecting the northern half of the site, with drainage ponds adjacent to this.</p> <p>A review of Flood Maps for Planning (Gov.uk, 2021) shows the site is not located within a flood zone.</p> <p>The site is not subject to any listed structures, however further to the south-east are three scheduled monuments (Historic England Listing Map, 2021).</p> <p>The western half of the site is located within a Source Protection Zone 3 (DM10) and includes several areas of land designated as a Site of Interest in Nature Conservation (Core Policy 12 and DM7) with a Regionally Important Geology Site (Core Policy 12) towards the centre of the site.</p> <p>The Brickworks itself is designated as a hazardous installation (DM10).</p> <p>Bordering the site to the south-east is a Site of Interest in Nature Conservation containing an Ancient Woodland.</p> <p>There may be land stability and ground contamination present.</p>	Poor
Barriers to Delivery and Mitigation (including ownership constraints - if known)	<p>Development proposals within and with the potential to impact on the Groundwater Source Protection Zone should address the potential risk through mitigation as part of the development or through off site measures where necessary.</p> <p>Any redevelopment of the site would need to assess the impact upon the sites of Interest in Nature Conservation within the site and mitigate any impact.</p> <p>Potential contamination may require mitigation as part of a wider quarry restoration scheme.</p> <p>The railway line intersecting the site may constrain redevelopment of the site.</p>	Poor
Market Attractiveness (including appropriateness, vacancy and market activity on site for the type of	<p>This is a large site on the outskirts of Kirton and in close proximity to Boughton and Ollerton/New Ollerton. It is occupied by the Kirton Brickworks</p>	Average

development proposed)	and clay pit, operated by Forterra. It is an important local employment site. There are a number of constraints affecting any future redevelopment of the site.	
Strategic Fit with Growth Area Objectives (by target Market Segment)	The site already accommodates key industrial growth sectors as identified in the D2N2 Vision 2030 document including extractive industries and construction.	Good
OVERALL SITE RATING	Average / Poor	
Recommendation and Potential Future Uses	Do not allocate for employment uses (i.e. retain designation as a permitted site for the extraction of minerals - brick clay)	
SITE SUMMARY:		
<p>The site is occupied by Kirton Brickworks and clay pit, operated by Forterra – one of the largest manufacturers of building products in the UK. The site incorporates the brickworks itself and land used for the extraction of clay. The site is 200m east of the Boughton Industrial Estate. There are a number of constraints to redevelopment of the site including, the remediation of any land contamination as part of wider quarry restoration scheme, the gently undulating topography, the railway line intersecting the site, the environmental designations within and adjacent the site, nearby scheduled monuments, the ground water protection status of areas of the site and the hazardous installation designation.</p> <p>However, the current workings at Kirton brickworks are being progressively restored back to their previous agricultural use, by reprofiling the hillside from which the clay has been extracted. It is recommended that the designation as a permitted site for the extraction of minerals (brick clay) be retained. Do not allocate for office/industrial or distribution uses. It is the responsibility of the County Council to make any changes any to this allocation (Publication Version of the draft Nottinghamshire Minerals Local Plan allocation number: MP6a).</p>		

Belle Eau Park (Ref: NSDC18)



**GROSS SITE AREA:
17.99 ha**

**ESTIMATED NET DEVELOPABLE AREA:
1.9 ha**

(Note: comprising of the undeveloped plot within the Lineage site and a 95% gross to net developable area).

CRITERIA	COMMENT	RATING
<p>Site Context</p> <ul style="list-style-type: none"> • Location with regards to existing employment areas and other sites • How the site fits into the overall portfolio 	<p>This is an existing employment site in the open countryside, the nearest village is Bilsthorpe/Bilsthorpe Moor approximately 0.8km to the north west. It is in a relatively remote location and is not within close proximity of any other strategic employment sites.</p>	
<p>Local Plan Designation</p>	<p>The Development Plan for the District comprises of the Amended Core Strategy (adopted 7th March 2019) and Allocations & Development Management (adopted 16 July 2013) Development Plan Document.</p> <p>The site is not subject to any planning policy designations within the Newark & Sherwood Local Development Framework.</p> <p>The site is located just beyond the boundaries of the urban boundary/village envelope (DM1) and the designated Source Protection Zone 3 (DM10).</p>	
<p>Status in SHLAA</p>	<p>N/A</p>	
<p>Planning History</p>	<p>Recent planning history includes:</p> <ul style="list-style-type: none"> • 20/SCR/00005 - Screening Opinion for proposed erection of extension to existing Lineage warehouse/distribution centre to create additional floorspace for B8 use (storage and distribution), parking and associated works (planning application 20/00636/FULM) 	

	<ul style="list-style-type: none"> • 20/00636/FULM - Erection of extension to existing Lineage warehouse/distribution centre to create additional floorspace for B8 use (storage and distribution), parking and associated works – Refused • 04/01076/FUL - Proposed new quality assurance building - 7.89ha/78937m2 	
Current Use and Land Type	This is a brownfield site occupied by employment uses.	
Occupier Profile (if partly developed, including % of available land and levels of vacancy onsite)	<p>This is an existing employment site occupied by a range of larger industrial and warehousing units and smaller workshops/offices. Occupiers include: Lineage Logistics (food distribution) and Brakes (wholesale food supplier) occupy the southern half of the site Noble (fresh food supplier) BSSB Contract Services (building maintenance and repairs) MBS Motor Factors vehicle repair MLB Engineering Oasis Image Studio (photography) Cedar House modern office suites.</p> <p>All units appeared to be occupied at the time of the site visit (December 2020). There are some older units in poor condition in the northern half of the estate, the Noble Foods and Lineage premises are modern purpose-built premises and the Cedar House offices have been refurbished recently.</p> <p>There is an undeveloped plot within the south of the site, which is part of the wider Lineage logistics site, it comprises of approximately 2ha.</p>	
Strategic Road Access	The site is approximately 0.8 km from the A617 (Kirklington Road). The site is approximately 19.7km from the A1 via the A617.	Poor
Local Road Access	The site has two access roads off Kirklington Road which joins the A617 under 1km from the site. The A617 is a good free-moving road which continues West towards Mansfield and Sutton-in-Ashfield and South East towards Newark but is constrained by speed restrictions and residential areas in places.	Good
Proximity to Urban Areas and Access to Labour and Services (including public transport / cycling / walking accessibility)	<p>The residential village of Bilsthorpe/Bilsthorpe Moor are approximately 0.8km from the site to the North West. Bilsthorpe provides some local shops and amenities including a post office.</p> <p>The site is not serviced by public transport with the nearest local bus stops being 1km from the entrance to the site on Farnsfield Road. Buses from these stops provide regular services to Mansfield, Nottingham, Ollerton and Eakring.</p>	Very Poor
Compatibility of Adjoining	The site is surrounded by greenfield land with	Average

<p>Uses (including amenity impacts experienced by current/future occupiers and neighbouring areas)</p>	<p>Kirklington Road bordering the site to the South West. The site wraps around a residential property accessed from Kirklington Road.</p>	
<p>Developmental and Environmental Constraints (e.g. size; topography; site access; roads, lighting, landscaping, mains utilities and communications infrastructure; flood risk; contamination; nature and heritage conservation)</p>	<p>This is an existing employment area with utilities and communications infrastructure in place. Some the access roads around the northern portion of the site are unmade.</p> <p>A review of Flood Maps for Planning (Gov.uk, 2021) shows the site is not located within a flood zone.</p> <p>The site is not subject to any listed structures nor are there any within the immediate locality (Historic England Listing Map, 2021).</p> <p>The site is adjacent to open countryside and there are mature trees on site.</p> <p>Access through the site to Robin Hood Retreat Camping and Caravanning Park to the north.</p>	<p>Good</p>
<p>Barriers to Delivery and Mitigation (including ownership constraints - if known)</p>	<p>There is an undeveloped plot within the south of the site, which is part of the wider Lineage logistics site.</p>	<p>Good</p>
<p>Market Attractiveness (including appropriateness, vacancy and market activity on site for the type of development proposed)</p>	<p>This employment site is in a relatively remote location although all units appeared to be occupied. There is an undeveloped plot within the south of the site, part of the wider Lineage logistics site.</p>	<p>Poor</p>
<p>Strategic Fit with Growth Area Objectives (by target Market Segment)</p>	<p>The site already accommodates key industrial growth sectors as identified in the D2N2 Vision 2030 document including Food & Drink Manufacturing, Logistics and e-commerce, Professional/Business Services and Construction. The site has potential to accommodate other key industrial growth sectors albeit it is located within open countryside and has relatively poor strategic road access.</p>	<p>Average</p>
<p>OVERALL SITE RATING</p>	<p>Average / Poor</p>	
<p>Recommendation and Potential Future Uses</p>	<p>Allocate for employment uses</p>	
<p>SITE SUMMARY:</p>		
<p>This is an existing employment site in the open countryside, the nearest village is Bilsthorpe/Bilsthorpe Moor approximately 0.8 km to the north west. It is in a relatively remote location and is not within close proximity of any other strategic employment sites. It is primarily occupied by purpose-built food and drink manufacturing and logistics premises. There is also a</p>		

small, modern office block as well as smaller, more dated workshops, some of which are in poor condition. However, all units appeared to be occupied and there is an undeveloped plot within the south of the site, part of the wider Lineage logistics site.

The site is unallocated in the Local Plan and despite its relative remoteness, recent applications suggest that there remains development interest in the site going forward. It is recommended that it is allocated for employment uses going forward.

Blidworth Industrial Park (Ref: NSDC19)

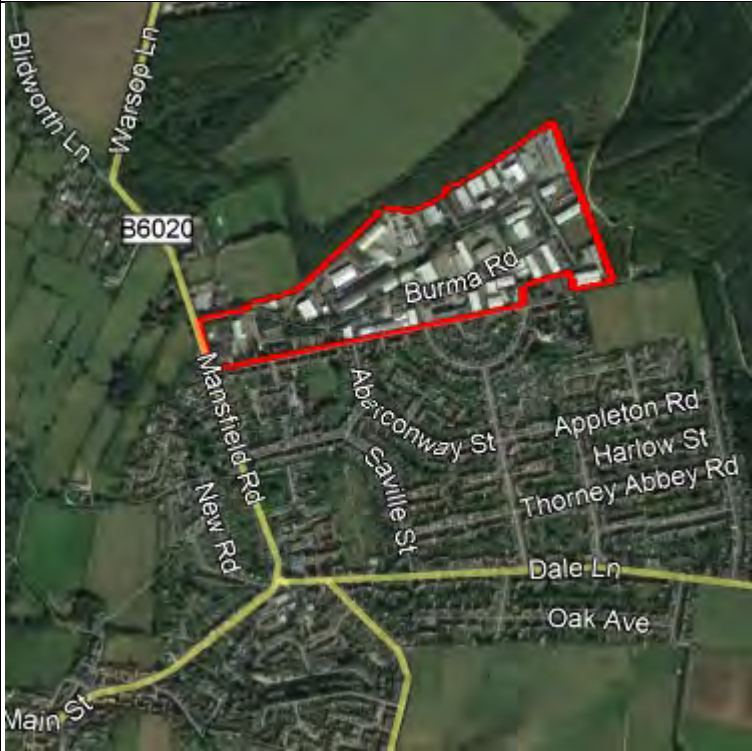

**GROSS SITE AREA:
15.75 ha**

**ESTIMATED NET DEVELOPABLE AREA:
0.33 ha**

(Note: comprising of an undeveloped plot at the intersection of Burma Road and Gilbert Way allocated for employment - BI/E/1)

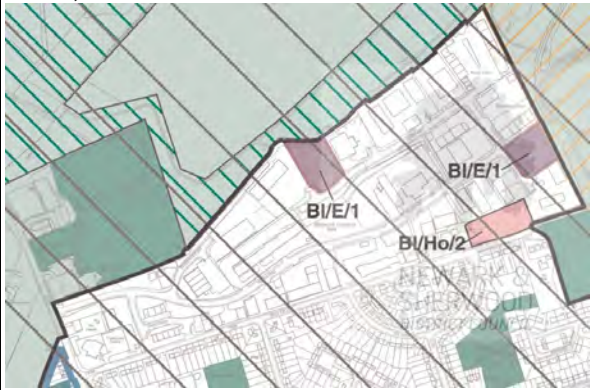
CRITERIA	COMMENT	RATING
<p>Site Context</p> <ul style="list-style-type: none"> • Location with regards to existing employment areas and other sites • How the site fits into the overall portfolio 	<p>This site is part of the wider former Blidworth Colliery site and is occupied by the well-established and popular Blidworth Industrial Estate, as well as Blidworth Fire Station and Blidworth Leisure Centre. It is located within the village of Blidworth and is not in close proximity to any other strategic employment sites.</p>	
<p>Local Plan Designation</p>	<p>The Development Plan for the District comprises of the Amended Core Strategy (adopted 7th March 2019) and Allocations & Development Management (adopted 16 July 2013) DPD.</p>  <p>The majority of the site is unallocated within the LDF. Two small areas within the site however are allocated as employment sites (BI/E/1) - a total of 1 ha. One of these sites comprises of an undeveloped plot (0.33ha) to the eastern side of the site at</p>	

	<p>the intersection of Burma Road and Gilbert Way. The other is within the north of the site off Leach Way and is currently in use as open-air storage for adjacent businesses.</p> <p>The site is also designated as a Source Protection Zone 3 (DM10), bordering a National/Local Nature Reserve to the north and Site of Interest in Nature Conservation to the east (Core Policy 12 and DM7).</p> <p>To the north, the site borders the Green Belt (SP4A/4B, Amended Core Strategy, 2019) and an area of land designated for public open space/school playing fields (Spatial Policy 8). The rectangular area excluded from the sites borders to the east is allocated for housing (Bi/Ho/2 – Bilsthorpe – Housing Site 2, Allocations & Development Management DPD, 2013).</p> <p>The site is also contained within the urban boundary/village envelope (DM1) as defined in the Newark & Sherwood Local Development Framework Policies Map.</p>
Status in SHLAA	Site Ref: Blidworth Industrial Park (08_0603) for 12 proposed dwellings. The site could be available in 10-15 years.
Planning History	<p>Recent planning history includes:</p> <ul style="list-style-type: none"> • 21/00172/FUL - Extension to side of existing unit • 20/02438/FUL - Proposed two story industrial unit • 20/01663/FUL - Proposed industrial unit to connect to existing unit • 20/00838/FUL - Remove the existing dilapidated single storey office unit and replace with a new two storey office • 15/00662/FULM - Proposed Industrial Units - 0.33ha (unimplemented)
Current Use and Land Type	This is a brownfield site occupied by an industrial estate.
Occupier Profile (if partly developed, including % of available land and levels of vacancy onsite)	<p>This is an established industrial estate accommodating a range of industrial units, smaller workshops and offices. The majority of units were in good condition and the working environment was of a good quality. Occupiers included:</p> <p>Sign up Systems (graphic specialist for events and exhibitions) Ulyett Landscapes (landscape gardener) Flowerline Florist John Walker Timber Midway Fencing Contractors Scott Engineering and Fabrication Desman Engineering (precision engineering) Corden Group (construction equipment manufacturing) Multy Forktruck dealer BTP Wholesale Trailer Parts</p> <p>Fairdale House Offices – Clarity Homecare (health service provider) and smaller workshops at Boundary Court and Hazel Court.</p>

	<p>Blidworth Fire Station and Blidworth Leisure Centre are also within the site at the intersection of Mansfield Road and Belle Vue Lane.</p> <p>At the time of the site visit (December 2020) only two industrial units were on the market comprising of Units 1 & 2 Burma Road (415 sqm), however they were under offer.</p> <p>There is one remaining undeveloped plot to the eastern side of the site at the intersection of Burma Road and Gilbert Way. It comprises of 0.33 ha, is allocated for employment development (Bl/E/1) and has historical permission for industrial units (15/00662/FULM). The other site allocated for employment development is within the north of the site off Leach Way and is currently in use as open-air storage for adjacent businesses.</p>	
Strategic Road Access	The site is accessed off the B6020 Mansfield Road which joins both the A614, A60 and A617 within 5km. Junction 27 of the M1 is approximately 13.8km from the site.	Very Poor
Local Road Access	The site has one main access road (Burma Road) off the B6020 (Mansfield Road). The B6020 joins the A617 to the North after approximately 4km and the A60 to the West after approximately 4.8km. The B6020 is constrained by residential areas, schools and various speed restrictions/junctions.	Poor
Proximity to Urban Areas and Access to Labour and Services (including public transport / cycling / walking accessibility)	The site is situated on the northern edge of the village of Blidworth. Blidworth provides a school, medical centre and various local shops and amenities including a leisure centre. Bus stops less than 0.1km from the site entrance provide regular services to Mansfield and limited services to Sutton-in-Ashfield, Nottingham, Newark, Bilsthorpe and Eakring.	Average
Compatibility of Adjoining Uses (including amenity impacts experienced by current/future occupiers and neighbouring areas)	The site is bordered by residential areas to the South, greenfield land to the North and East and the B6020 to the West. Blidworth Miners Social Club and recreational land adjoins the site to the North off the B6020.	Poor
Developmental and Environmental Constraints (e.g. size; topography; site access; roads, lighting, landscaping, mains utilities and communications infrastructure; flood risk; contamination; nature and heritage conservation)	<p>This is an existing employment site with communications and utilities infrastructure in place. Internal access roads within the estate are in good condition.</p> <p>A review of Flood Maps for Planning (Gov.uk, 2021) shows the site is not located within a flood zone.</p> <p>The site is not subject to any listed structures nor are there any located in the immediate locality (Historic England Listing Map, 2021).</p> <p>Land to east is Green Belt. Designated Local Wildlife</p>	Good

	Site – Blidworth Colliery Spoil (Dismantled Railway) Path located along north boundary.	
Barriers to Delivery and Mitigation (including ownership constraints - if known)	Potential contamination issues on the site. Any redevelopment would also need to take into consideration the impact on neighbouring uses including residential properties, leisure uses and environmental designations, in addition to the source protection zone designation on the site.	Average
Market Attractiveness (including appropriateness, vacancy and market activity on site for the type of development proposed)	This employment site is conveniently located within Blidworth village with easy access to local services and labour market. The industrial estate is well-established, and the units were in decent condition. Vacancy levels were low at the time of the site visit.	Good
Strategic Fit with Growth Area Objectives (by target Market Segment)	The site already accommodates key industrial growth sectors as identified in the D2N2 Vision 2030 document including Health/Social Care, Transport Equipment Manufacturing, Professional/Business services, Construction and Retail. The site has potential to accommodate other key industrial growth sectors albeit it has relatively poor strategic road access.	Good
OVERALL SITE RATING	Average	
Recommendation and Potential Future Uses	Allocate for employment uses. Protect remaining site for employment uses and retain existing allocations within that overall designation.	
SITE SUMMARY:		
<p>This site is part of the wider former Blidworth Colliery site and is occupied by the well-established and popular Blidworth Industrial Estate as well as Blidworth Fire Station and Blidworth Leisure Centre. It is located within the village of Blidworth and is not within close proximity to any other strategic employment sites. The majority of units were in good condition and the working environment was of a good quality, vacancy levels were low at the time of the site visit. The majority of the site is unallocated within the Local Plan except for two small areas allocated as employment sites (BI/E/1) - a total of 1 ha. One of these sites comprises of an undeveloped plot (0.33ha) to the eastern side of the site at the intersection of Burma Road and Gilbert Way. The other is within the north of the site off Leach Way and is currently in use as open-air storage for adjacent businesses. It is recommended that the undeveloped land is allocated for employment uses and the developed areas protected for employment uses, with the existing allocated sites within that overall designation retained.</p>		

Land North of the A17 (NUA/MU/1) (Ref: NSDC20)



**GROSS SITE AREA:
21.79 ha**

**ESTIMATED NET DEVELOPABLE AREA:
6.32 ha**

(Note: based on 50% of site being brought forward for employment (10.88 ha) as per the Allocations DPD excluding Wirtgen Group site (3.86 ha) and a 90% gross to net adjustment applied. The areas being developed for the agricultural machinery dealership and coffee shop have not been deducted as it assumed they are included within the 50% of the site being brought forward for non-employment uses)

CRITERIA	COMMENT	RATING
<p>Site Context</p> <ul style="list-style-type: none"> • Location with regards to existing employment areas and other sites • How the site fits into the overall portfolio 	<p>This site is north of the A17 on the disused airfield south of Newark & Nottinghamshire Agricultural Society Showground. It is an allocated mixed-use site and is partly developed – Wirtgen Group machinery manufacturer occupy the eastern portion.</p> <p>The Dixons Mastercare site is opposite this site on the southern side of the A17. The site is also within close proximity of the Brunel Drive industrial area to the west of the A1.</p>	
<p>Local Plan Designation</p>	<p>The Development Plan for the District comprises of the Amended Core Strategy (adopted 7th March 2019) and Allocations & Development Management (adopted 16 July 2013) Development Plan Document. The site is allocated as a mixed-use site with Planning Permission (April 2011) (NUA/MU/1 – Newark Urban Area – Mixed Use Site 1, Allocations & Development Management DPD, 2013). The site will accommodate a Hotel/Conference Facility, restaurant facilities to support the wider showground uses, and employment uses. The Allocations DPD assumes 50% of the site will be brought forward for employment</p>	

	<p>(10.88ha). The site is also located within the Newark Showground Policy Area (NUA/SPA/1).</p> <p>Beyond the A46 to the north is a Conservation Area (Core Policy 14 and DM9) with land designated as open breaks within the Newark & Sherwood Local Development Framework Policies Map. To the south of the site, across the A17, is a small area of land allocated for employment use (with planning permission).</p> <p>The site is also located on the border of the urban boundary/village envelope (DM1) as defined in the Newark & Sherwood Local Development Framework Policies Map.</p>
Status in SHLAA	Site Ref: Newark Showground (08_0690) (Winthorpe). The site is identified as being not suitable.
Planning History	<p>Recent planning history:</p> <p>20/01219/FULM - Erection of an agricultural machinery dealership (Use Class: Sui Generis) comprised of maintenance, sale and repair with associated infrastructure – Granted – 12.10.2020 – This site comprises of 2.02ha of land adjacent to the A17 and to the west of the Wirtgen Group site. This permission is being implemented.</p> <p>16/01796/FULM - Vehicle/plant servicing and repair workshop, storage, office, sales etc – 3.86 ha - Granted 27.01.2017. This relates to the Wirten Group site.</p> <p>20/00217/FUL - Erection of a coffee shop with drive thru and associated infrastructure - Land Rear of The Friendly Farmer Fosse Road Winthorpe Nottinghamshire – Granted 06.04.2020. This permission was being implemented at the time of the site visit.</p> <p>PRE/00338/11 – Pre-application request for an eco-motel.</p>
Current Use and Land Type	This is a brownfield site formerly in use as an airfield. It is now being redeveloped for a mix of uses.
Occupier Profile (if partly developed, including % of available land and levels of vacancy onsite)	<p>The site is partly developed – Wirtgen Group machinery manufacturer occupy the eastern portion. A permission for a coffee shop with drive thru on the western portion is being implemented and pre-application discussions regarding an eco-motel have taken place. Permission was also recently granted for an agricultural machinery dealership comprised of maintenance, sale and repair with associated infrastructure.</p> <p>The Wirtgen Group sites occupies 3.86 ha. The area of land being developed for the coffee shop and drive thru comprises of 0.24 ha. The area of land being developed for the agricultural</p>

	<p>machinery dealership comprises of 2.02ha. Therefore, the land remaining for development within the wider site comprises of approximately 15.67 ha gross.</p>	
Strategic Road Access	<p>The A17 and A46 run adjacent to the site and the A1 is less than 1km away.</p>	Very Good
Local Road Access	<p>The site looks to be accessible by road via the Newark Showground entrance off Drove Lane. The site adjoins the A17 to the South and the A46 to the West, however, there is currently no direct access onto the site from either of these roads. Both the A17 and A46 share a junction with the A1 which can be accessed within 1km from the site.</p> <p>The A46 and A17 are a good, free-flowing roads avoiding larger residential areas. The A46 continues Northwards from the site towards Lincoln and Southwards towards Leicester.</p>	Very Good
Proximity to Urban Areas and Access to Labour and Services (including public transport / cycling / walking accessibility)	<p>The site is situated on the North Eastern outskirts of the residential town of Newark-upon-Trent. Newark provides a wide range of services and amenities including a hospital, schools, a shopping centre, retail park, restaurants and various recreational facilities.</p> <p>The smaller residential village of Winthorpe is situated to the West of the site beyond the A46. Winthorpe provides few local amenities other than a school, local post office and community centre.</p> <p>There are no local bus stops servicing the site. Newark Northgate railway station provides regular train services towards Nottingham, Lincoln and London – the station is 4.3km from the site to the South West but is not directly accessible by public transport.</p>	Average / Poor
Compatibility of Adjoining Uses (including amenity impacts experienced by current/future occupiers and neighbouring areas)	<p>The site is situated to the South of Newark Showground and is bordered by the A17 to the South and the A46 to the West.</p>	Good
Developmental and Environmental Constraints (e.g. size; topography; site access; roads, lighting, landscaping, mains utilities and communications infrastructure; flood risk; contamination; nature and heritage conservation)	<p>A review of Flood Maps for Planning (Gov.uk, 2021) shows the site is not located within a flood zone. There may be surface water drainage issues on the site and the site is located north of an IDB maintained waterway.</p> <p>The site is not subject to any listed structures nor are there any within the immediate locality (Historic England Listing Map, 2021).</p>	Very Good

	A public right of way crosses the site near the entrance.	
Barriers to Delivery and Mitigation (including ownership constraints - if known)	Aside from potential surface water drainage issues, no other barriers to development were evident at the site visit.	Very Good
Market Attractiveness (including appropriateness, vacancy and market activity on site for the type of development proposed)	This site has very good strategic road access with significant visibility from adjoining highways and is within close proximity of Newark.	Very Good
Strategic Fit with Growth Area Objectives (by target Market Segment)	This site already accommodates key industrial growth sectors as identified in the D2N2 Vision 2030 document including transport equipment manufacturing. The site has potential to accommodate other key industrial growth sectors on the undeveloped areas of the site.	Good
OVERALL SITE RATING	Good	
Recommendation and Potential Future Uses	Designate for mixed-use with an element of employment uses (i.e. retain mixed-use allocation NUA/MU/1 – Newark Urban Area – Mixed Use Site 1, Allocations & Development Management DPD, 2013)	
SITE SUMMARY:		
This site is north of the A17 on the disused airfield south of Newark & Nottinghamshire Agricultural Society Showground. It is an allocated mixed-use site to accommodate a Hotel/Conference Facility, restaurant facilities to support the wider showground uses, and employment uses. The site is partly developed – Wirtgen Group machinery manufacturer occupy the eastern portion. A permission for a coffee shop with drive thru on the western portion is being implemented, permission has also been granted for an agricultural machinery dealership and pre-application discussions regarding an eco-motel have taken place. It is recommended that the site is designated for mixed-use with an element of employment uses.		

Land at NSk, Northern Road (NUA/MU/3) (Ref: NSDC21)



**GROSS SITE AREA:
10.11 ha**

**ESTIMATED NET DEVELOPABLE
AREA:
0 ha**

CRITERIA	COMMENT	RATING
<p>Site Context</p> <ul style="list-style-type: none"> • Location with regards to existing employment areas and other sites • How the site fits into the overall portfolio 	<p>This site comprises of existing employment uses adjacent to the well-established and popular Newark Industrial Estate which is situated on the north-eastern side of Newark-upon-Trent. The primary occupier is the NSK Europe Ltd headquarters (bearings manufacturer).</p>	
<p>Local Plan Designation</p>	<p>The Development Plan for the District comprises of the Amended Core Strategy (adopted 7th March 2019) and Allocations & Development Management (adopted 16 July 2013) Development Plan Document. The site is allocated as a mixed-use site with Planning Permission (April 2011) (NUA/MU/3 – Newark Urban Area – Mixed Use Site 3, Allocations & Development Management DPD, 2013). The site will accommodate around 150 dwellings, employment provision and retail provision up to 10,000 square metres (net).</p> <p>To the north-east, the site immediately borders and Industrial Estate/Existing Employment Policy Area (NUA/E/1 – Newark Urban Area – Newark Industrial Estate Policy Area) and to the west, the railway line and adjoining area are designated as transport allocation NUA/Tr/1/ - Northgate Station Policy Area (Allocations & Development Management DPD, 2013). Further to the east of the site is Site of Interest in Nature Conservation (Core Policy 12 and DM7).</p> <p>The site is also contained within the urban boundary/village envelope (DM1) as defined in the Newark & Sherwood Local</p>	

	Development Framework Policies Map.	
Status in SHLAA	Site Ref: NSK Europe Limited, Northern Road (08_0310) for a proposed yield of 381 dwellings (viable at 50dph). The site could be available in 5-10 years.	
Planning History	Recent planning history includes: <ul style="list-style-type: none"> 14/02212/FUL - Reconfiguration from two units to four units, CU within B class - 0.42ha/4236m2 	
Current Use and Land Type	This is a brownfield site occupied by employment uses.	
Occupier Profile (if partly developed, including % of available land and levels of vacancy onsite)	<p>This site is primarily occupied by NSK Europe Ltd which manufactures bearings. This plant has a history of over 100 years and this site is the company headquarters.</p> <p>Other occupiers include Abbott & Co (manufacturers of air receivers and pressure vessels), We only MOT and Richmond Plant and Tool Hire.</p> <p>At the time of the site visit (December 2020) there were two spaces available to let in the modern warehouse development at Mayden Park between Northern Road and the railway line. The ground floor (132 sqm) and first floor (352 sqm) were available.</p> <p>The site is fully developed.</p>	
Strategic Road Access	The A1 is accessible approximately 2km from the site entrance via Beacon Hill Road/Beckingham Road.	Average
Local Road Access	The site's access road (Northern Road) can be accessed off Lincoln Road (B6166) to the North and from The South via Beacon Hill Road. Both Lincoln Road and Beacon Hill Road are good, free-moving roads but travel through residential areas in places.	Good
Proximity to Urban Areas and Access to Labour and Services (including public transport / cycling / walking accessibility)	<p>The site is situated to the North East of the residential town of Newark-upon-Trent. Newark provides a wide range of services and amenities including a hospital, schools, a shopping centre, retail park, restaurants and various recreational facilities.</p> <p>Newark Northgate railway station provides regular train services towards Nottingham, Lincoln and London – the station is 1.1km from the site to the West by foot via a public footpath and via National Cycle Route 64, both of which</p>	Good / Very Good

	<p>run alongside the site beyond the railway line to the West and can be accessed via Beacon Hill Road.</p> <p>Bus stops on Beacon Hill Road (approximately 0.3km from the site) provide hourly services between 08:30am and 18:30pm to Coddington and Newark centre.</p>	
<p>Compatibility of Adjoining Uses (including amenity impacts experienced by current/future occupiers and neighbouring areas)</p>	<p>The site is bordered by further industrial/retail units to the North and North East, mature trees with recreational land beyond to the East, Beacon Hill Road to the South and the East Midlands Railway line to the West.</p> <p>Beacon Hill Retail Park is located immediately adjacent to the south.</p>	Good
<p>Developmental and Environmental Constraints (e.g. size; topography; site access; roads, lighting, landscaping, mains utilities and communications infrastructure; flood risk; contamination; nature and heritage conservation)</p>	<p>This is a relatively level site occupied by employment uses with existing utilities and communications infrastructure.</p> <p>A review of Flood Maps for Planning (Gov.uk, 2021) shows the site is not located within a flood zone.</p> <p>The site is not subject to any listed structures; however, Beacon Hill Tollhouse is located on the site's southern boundary, a Grade II Listed structure on Beacon Hill Road (Historic England Listing Map, 2021).</p>	Average
<p>Barriers to Delivery and Mitigation (including ownership constraints - if known)</p>	<p>No ownership constrains (0-5 years) (SHLAA).</p> <p>No other barriers to redevelopment were evident at the site visit.</p>	Very Good
<p>Market Attractiveness (including appropriateness, vacancy and market activity on site for the type of development proposed)</p>	<p>This site has good proximity to urban areas and services. It is adjacent to a well-established and popular industrial estate on the edge of Newark and would be an attractive location for a range of occupiers.</p>	Good
<p>Strategic Fit with Growth Area Objectives (by target Market Segment)</p>	<p>This site already accommodates key industrial growth sectors as identified in the D2N2 Vision 2030 document including Transport Equipment Manufacturing. The site has the potential to accommodate further businesses within key growth sectors.</p>	Good
<p>OVERALL SITE RATING</p>	Good	
<p>Recommendation and</p>	Protect for mixed-use with an element of employment uses	

Potential Future Uses	
------------------------------	--

SITE SUMMARY:

<p>This site is fully developed and comprises of existing employment uses adjacent to the well-established and popular Newark Industrial Estate which is situated on the north-eastern side of Newark-upon-Trent. The primary occupier is the NSK Europe Ltd headquarters (bearings manufacturer). The site is allocated as a mixed-use site in the Local Plan for around 150 dwellings, employment provision and retail provision up to 10,000 square metres (net).</p>
--

<p>This site has good access to labour supply and services, including the adjacent Beacon Hill retail park. It is recommended that the site is protected for mixed-use with an element of employment uses.</p>
--

Land west of the A1 on Stephenson Way (NUA/E/2) (Ref: NSDC22)



**GROSS SITE AREA:
9.30 ha**

**ESTIMATED NET DEVELOPABLE AREA:
7.56 ha**
(Note: excludes 1.34ha developed within northern site and 95% gross to net adjustment applied)

CRITERIA	COMMENT	RATING
<p>Site Context</p> <ul style="list-style-type: none"> • Location with regards to existing employment areas and other sites • How the site fits into the overall portfolio 	<p>This greenfield site provides natural expansion space for the adjacent Newark Industrial Estate. It is adjacent to the A1 and immediately west of the Dixons Mastercare site. The land between the two areas outlined in red has been developed for a Moy Park hatchery (agricultural use) (ref. 16/00166/FULM).</p>	
<p>Local Plan Designation</p>	<p>The Development Plan for the District comprises of the Amended Core Strategy (adopted 7th March 2019) and Allocations & Development Management (adopted 16 July 2013) Development Plan Documents. The site is allocated for employment development (NUA/E/2 – Newark Urban Area – Employment Site 2, Allocations & Development Management DPD, 2013). The site is also included within the Industrial Estate/Existing Employment Policy Area (NUA/E/1, Allocations & Development Management DPD, 2013).</p> <p>The site also borders land allocated for employment along its southern border and land allocated for mixed use along its northern border (NUA/MU/2). The site is contained within the urban boundary/village envelope (DM1) as defined in the Newark & Sherwood Local Development Framework Policies Map.</p>	
<p>Status in SHLAA</p>	<p>N/A</p>	
<p>Planning History</p>	<p>Recent applications include:</p>	

	<p>18/00708/FUL - Containerised self-storage - 0.48ha/4757sqm 18/01122/FUL - Motor vehicle storage - 0.86ha/8576sqm 10/01349/FUL - Proposed new secure vehicle parking depot - 0.58ha/5825sqm 20/00309/FULM - Erection of proposed builder's merchant - 0.81ha/8056sqm</p> <p>Land to the north of the southern site adjacent to Stephenson Way has permission for a builder's merchant (20/00309/FULM) and a BIO-CNG fuelling station (19/01631/FUL). Land to the south of the southern site has been subject to a screening opinion (ref. 16/SCR/00001) for industrial development.</p>	
Current Use and Land Type	This is a greenfield site; the northern area is partially developed for motor vehicle storage and self-storage.	
Occupier Profile (if partly developed, including % of available land and levels of vacancy onsite)	<p>The northern site has been partially developed: Compound 1 (18/00708/FUL) 0.48ha of containerised self-storage occupied by Loc-Box; and Compound 2 (18/01122/FUL) 0.86ha of motor vehicle storage associated with Brownhills Motorhomes adjacent.</p> <p>The southern site is vacant greenfield land.</p> <p>The land between the two areas outlined in red has been developed for a Moy Park hatchery (agricultural use) (ref. 16/00166/FULM).</p>	
Strategic Road Access	The A1 borders the site to the East and can be accessed from the junction approximately 200m north of the site.	Good / Very Good
Local Road Access	Access to the sites is via Brunel Drive, then Stephenson Way. There is the possibility of continuing established roads within the adjoining industrial/retail areas to the West in order to create access.	Good
Proximity to Urban Areas and Access to Labour and Services (including public transport / cycling / walking accessibility)	<p>The site is situated to the North East of the residential town of Newark-upon-Trent. Newark provides a wide range of services and amenities including a hospital, schools, a shopping centre, retail park, restaurants and various recreational facilities.</p> <p>Newark Northgate railway station provides regular train services towards Nottingham, Lincoln and London – the station is 2.3km from the Northern edge of the site to the South West but is not directly accessible by public transport with the nearest bus stops into Newark Centre being along Lincoln Road approximately 1km from the site.</p>	Good

Compatibility of Adjoining Uses (including amenity impacts experienced by current/future occupiers and neighbouring areas)	The site is bordered by established industrial/retail units to the West and by the A1 to the North and East. Greenfield land borders the site to the South.	Very Good
Developmental and Environmental Constraints (e.g. size; topography; site access; roads, lighting, landscaping, mains utilities and communications infrastructure; flood risk; contamination; nature and heritage conservation)	<p>This is a greenfield site adjacent to the Newark industrial estate.</p> <p>A review of Flood Maps for Planning (Gov.uk, 2021) shows the site is not located within a flood zone. The main river is located to the west of the site.</p> <p>Slough Dyke, possible hazardous landfill gases within the site.</p> <p>The site is not subject to any listed structures nor are there any in the immediate locality (Historic England Listing Map, 2021). However, the site is close to areas where significant archaeological items from Civil War could be found.</p>	Average
Barriers to Delivery and Mitigation (including ownership constraints - if known)	Works to the access road may be required and impact upon traffic on Lincoln Road/Brunel Drive assessed and mitigated. Slough Dyke, possible hazardous landfill gases within the site. No other barriers to delivery were evident from the site visit.	Average
Market Attractiveness (including appropriateness, vacancy and market activity on site for the type of development proposed)	This site has good strategic road access and significant visibility from the adjoining A1. The site is within the wider Brunel Drive industrial area on the outskirts of Newark.	Good
Strategic Fit with Growth Area Objectives (by target Market Segment)	This site has potential to accommodate key industrial growth sectors as identified in the D2N2 Vision 2030 document.	Good
OVERALL SITE RATING	Good	
Recommendation and Potential Future Uses	Allocate for employment uses	
SITE SUMMARY:		
<p>This greenfield site provides natural expansion space for the adjacent Newark Industrial Estate. It is adjacent to the A1 and immediately west of the Dixons Mastercare site. The northern area is partially developed for motor vehicle storage and self-storage, the southern area is undeveloped greenfield land and the central site between the two has been developed for a Moy Park hatchery. The site is allocated as a new employment area in the Local Plan and it is recommended the site is allocated for employment uses.</p>		

NAP 2A Land south of Newark (Ref: NSDC23)



**GROSS SITE AREA:
48.77 ha**

**ESTIMATED NET DEVELOPABLE AREA:
43.89 ha**
(Note: based on a 90% gross to net adjustment)

CRITERIA	COMMENT	RATING
<p>Site Context</p> <ul style="list-style-type: none"> • Location with regards to existing employment areas and other sites • How the site fits into the overall portfolio 	<p>This is a large undeveloped greenfield site to the south of Newark-upon-Trent. The site forms part of the Strategic Site Designation Land South of Newark – NAP 2A. The sustainable urban extension comprises of up to 3,150 new homes, a strategic link road between the A1 and A46 and 49 ha of employment, as well as community facilities and open spaces. Outline permission has been granted for the wider development known as ‘Middlebeck’ with reserved matters permission for the first phases, development of these is underway. This site is identified for employment development within the approved outline planning permission.</p> <p>Saint Gobain Formula (manufacturer of industrial plaster and gypsum) is located immediately north of the site. Staple Quarry Landfill site is located approximately 400m south of the site.</p>	
<p>Local Plan Designation</p>	<p>The Development Plan for the District comprises of the Amended Core Strategy (adopted 7th March 2019) and Allocations & Development Management (adopted 16 July 2013) Development Plan Documents. The site forms part of the Strategic Site Designation (Land South of Newark – NAP 2A, Amended Core Strategy 2019).</p> <p>Bordering the site to the west is a Site of Interest in Nature Conservation (Core Policy 12 and DM7), with a Regionally Important Geology Site to the east (Core Policy 12).</p> <p>Further to the north, the site neighbours the Newark Southern Link Road (NAP 4, Core Strategy 2019).</p>	

	<p>The site is located on the outskirts of the urban boundary/village envelope (DM1) as defined in the Newark & Sherwood Local Development Framework Policies Map.</p>	
Status in SHLAA	<p>Site Ref: Land South of Newark (08_0318) (Hawton) for a proposed yield of 3100 dwellings. The site is economically viable/achievable for housing, available within 5 years. No ownership constrains – mainly in one land ownership.</p>	
Planning History	<p>Recent planning applications:</p> <ul style="list-style-type: none"> 19/01377/RMA - Two-storey building for use as an office and café – 118 sqm <p>Land south of Newark – Middlebeck Urban Extension:</p> <p>10/01586/OUTM - Outline planning application with means of access (in part) for development comprising demolition of existing buildings and the construction of up to 3,150 dwellings (Class 3); two local centres including retail and commercial premises (Classes A1 to A5), a 60 bed care home (Class 2), 2 primary schools, day nurseries/creches, multi-use community buildings including a medical centre (Class D1); a mixed use commercial estate of up to 50 hectares comprising employment uses (Class B1, B2 and B8) and a creche (Class D1); provision of associated vehicular and cycle parking; creation of ecological habitat areas; creation of general amenity areas, open space and sports pitches; creation of landscaped areas; new accesses for vehicles, pedestrians and cyclists (including the Southern Link Road); sustainable drainage measures, including storage ponds for surface water attenuation; associated engineering operations (including flood compensation measures); provision of utilities infrastructure; and all enabling and ancillary works.</p> <p>14/01978/OUTM - Application to vary conditions of Outline planning permission 10/01586/OUTM</p> <p>Multiple reserved matters permissions have also been granted for the first phases.</p>	
Current Use and Land Type	<p>This is an undeveloped greenfield site.</p>	
Occupier Profile (if partly developed, including % of available land and levels of vacancy onsite)	<p>N/A</p>	
Strategic Road Access	<p>The delivery of the southern link road between the A46 and A1 will significantly improve access to the site.</p> <p>The A1 can be accessed approximately 2.4km from the site.</p>	<p>Average</p>

<p>Local Road Access</p>	<p>There are three access gates from Grange Lane to the east for agricultural vehicles. Grange Lane has a 7.5 tonne weight limit.</p> <p>As part of the Middlebeck proposals, the access to the site via Grange Lane is proposed to be upgraded.</p> <p>There is currently no formal road access onto the site however, the site is bordered by Grange Lane to the East. The A1 can be accessed via Grange Lane and Staple Lane which are both free-moving but semi-rural roads which pass through some residential areas.</p>	<p>Average</p>
<p>Proximity to Urban Areas and Access to Labour and Services (including public transport / cycling / walking accessibility)</p>	<p>The site is approximately 2.3km from the residential town of Balderton/New Balderton and the smaller residential village of Fernwood to the North East. Fernwood provides a shop, primary school and limited local amenities.</p> <p>Balderton provides schools, a medical centre and various local shops and amenities.</p> <p>The site is not serviced by public transport with the nearest bus stops being within the village of Balderton. National Cycle Route 64 travels along the West of the site (although there is no direct access from the site itself) and continues North towards Newark on Trent and South towards Melton Mowbray.</p> <p>The site will be well located in relation to the facilities planned as part of the wider Middlebeck development.</p>	<p>Poor</p>
<p>Compatibility of Adjoining Uses (including amenity impacts experienced by current/future occupiers and neighbouring areas)</p>	<p>The site is bordered by Grange Lane to the East and National Cycle Route 64 to the West with mainly greenfield land beyond and to the South. There are quarry sites to the North beyond Bowbridge Lane and East beyond Grange Lane.</p>	<p>Very Good</p>
<p>Developmental and Environmental Constraints (e.g. size; topography; site access; roads, lighting, landscaping, mains utilities and communications infrastructure; flood risk; contamination; nature and heritage conservation)</p>	<p>This is a large, relatively level, undeveloped site.</p> <p>A review of Flood Maps for Planning (Gov.uk, 2021) shows parts of the site is located within a Flood Zone 2.</p> <p>The site is not subject to any listed structures however to the north-east of the site is Gypsum Grinding Mill, a Grade II listed building (Historic England Listing Map, 2021).</p> <p>There is a mound of c. 3m height in the centre of the site.</p>	<p>Good</p>

	<p>Bordering the site to the west is a Site of Interest in Nature Conservation (Core Policy 12 and DM7), with a Regionally Important Geology Site to the east (Core Policy 12).</p> <p>Development underway on Middlebeck.</p>	
<p>Barriers to Delivery and Mitigation (including ownership constraints - if known)</p>	<p>The delivery of the southern link road and upgrades to Grange Lane are proposed to enable access to the site for the proposed employment uses. No other barriers to delivery were evident from the site visit.</p>	Good
<p>Market Attractiveness (including appropriateness, vacancy and market activity on site for the type of development proposed)</p>	<p>This is a large site which is due to come forward within the Middlebeck sustainable urban extension. The delivery of the southern link road between the A46 and A1 will significantly improve access to the site. This site is likely to be attractive to a range of employment use occupiers. The site is currently on the market as 'Newark Gateway' - a design and build opportunity for up to 185,806 sqm industrial and logistics space.</p>	Good
<p>Strategic Fit with Growth Area Objectives (by target Market Segment)</p>	<p>This site has significant potential to accommodate key industrial growth sectors as identified in the D2N2 Vision 2030 document, particularly the logistics and e-commerce sector.</p>	Good
<p>OVERALL SITE RATING</p>	<p>Good</p>	
<p>Recommendation and Potential Future Uses</p>	<p>Allocate for employment uses (i.e. retain strategic site designation with employment uses on this site)</p>	
<p>SITE SUMMARY:</p> <p>This is a large undeveloped greenfield site to the south of Newark-upon-Trent. The site forms part of the Strategic Site Designation Land South of Newark – NAP 2A in the Local Plan. The sustainable urban extension comprises of up to 3,150 new homes, a strategic link road between the A1 and A46 and 49 ha of employment, as well as community facilities and open spaces. Outline permission has been granted for the wider development known as 'Middlebeck' with reserved matters permission for the first phases and development of these underway.</p> <p>This site is identified for employment development within the approved outline planning permission and is currently on the market as 'Newark Gateway' - a logistics and industrial opportunity. The proposed southern link road between the A46 and A1 and improvements to the site access along Grange Lane will significantly improve access to the site and enable delivery. Furthermore, the site will be well located in relation to the facilities planned as part of the wider Middlebeck development. It is recommended that the site is allocated for employment uses.</p>		

Land around Fernwood (NAP 2C) (Ref: NSDC24)



**GROSS SITE AREA:
14.20 ha**

**ESTIMATED NET DEVELOPABLE AREA:
13.49 ha**
(Note: based on a 95% gross to net ratio adjustment)

CRITERIA	COMMENT	RATING
<p>Site Context</p> <ul style="list-style-type: none"> • Location with regards to existing employment areas and other sites • How the site fits into the overall portfolio 	<p>This is an undeveloped grassland site immediately south of Fernwood Business Park and adjacent to the A1. It is immediately to the east of the Middlebeck sustainable urban extension.</p>	
<p>Local Plan Designation</p>	<p>The Development Plan for the District comprises of the Amended Core Strategy (adopted 7th March 2019) and Allocations & Development Management (adopted 16 July 2013) Development Plan Documents.</p> <p>The site is allocated as a Strategic Site (Land around Fernwood – NAP 2C) and Spatial Policy 5 (Delivering the Strategy) in the Core Strategy, 2019), it is identified for Use Class E office development.</p> <p>The site is also included within the Newark Urban Area – Phasing Policy (NUA/Ph/1, Allocations & Development Management DPD, 2013).</p> <p>Further to the north-east of the site, the Southern Link Road adjoins the B6326 (NAP 4, Core Strategy, 2019).</p> <p>The site is also contained within the urban boundary/village envelope (DM1) as defined in the Newark & Sherwood Local Development Framework Policies Map.</p> <p>The site is included within the ‘Fernwood Parish Neighbourhood Plan’ (2016-2031) boundary. There are no specific employment policies within the plan, however</p>	

	Community Objective 9 states a requirement for Pre-Application Community Consultation.	
Status in SHLAA	N/A	
Planning History	Recent planning history includes: 17/00347/DISCON - Request for confirmation that all conditions are discharged attached to planning permission 10/SCR/00001 Screening opinion request for mixed use & residential development. 10/SCR/00001 - Screening opinion request for mixed use & residential development. This relates to this site and the site to the south.	
Current Use and Land Type	This is a greenfield site in agricultural use.	
Occupier Profile (if partly developed, including % of available land and levels of vacancy onsite)	The site is undeveloped.	
Strategic Road Access	The A1 runs adjacent to the site to the West and can be accessed via a junction with the B6326 in approximately 1.6km Northbound and approximately 2km Southbound.	Good / Very Good
Local Road Access	The nearest vehicular access to the site is via Cross Lane and via William Hall Way to the North. Both roads are off the B6326 which is a good free-flowing road which shares junctions with the A1 to the North and South. There is no vehicular access on the site but there is potential access from an extension of the existing access stub road to the north of the site.	Very Good
Proximity to Urban Areas and Access to Labour and Services (including public transport / cycling / walking accessibility)	<p>There is a gym and Marstons restaurant at the Fernwood Business Park immediately north of the site. The site is to the South West of the residential village of Fernwood, a small, recently built village with basic local shops and amenities. The larger residential town of Balderton/New Balderton lies towards the North West of the site approximately 1.6km away via the B6326. Balderton provides schools, a medical centre and local shops and amenities.</p> <p>The residential town of Newark on Trent is approximately 5km from the site via the B6326. Newark on Trent provides a wide range of services and amenities including a hospital, schools, a shopping centre, retail park, restaurants and various recreational facilities.</p> <p>There is a limited irregular bus service from the</p>	Average

	B6326 approximately 0.5km from the site to Newark/Balderton and Grantham.	
Compatibility of Adjoining Uses (including amenity impacts experienced by current/future occupiers and neighbouring areas)	To the North, the site is adjacent to the partially developed Fernwood Business Park including The Suthers School and Lancaster Grange Assisted Living. The A1 borders the site to the West with the B6326 to the East with greenfield land beyond and the village of Fernwood beyond to the North East. A small residential farm plot borders the South Eastern corner of the site with greenfield land beyond to the South.	Good
Developmental and Environmental Constraints (e.g. size; topography; site access; roads, lighting, landscaping, mains utilities and communications infrastructure; flood risk; contamination; nature and heritage conservation)	This is a level site adjacent to the partially developed Fernwood Business Park. A review of Flood Maps for Planning (Gov.uk, 2021) shows the site is not located within a flood zone. There is a drainage pond within the north of the site. The site is not subject to any listed structures nor are there any within the immediate locality (Historic England Listing Map, 2021).	Very Good
Barriers to Delivery and Mitigation (including ownership constraints - if known)	Vehicular access to the site would need to be created from the road to the north. Consideration of adjoining uses, primarily The Suthers School and Lancaster Grange Assisted Living to the north and some residential properties to the south. No other barriers to development were evident from the site visit.	Good
Market Attractiveness (including appropriateness, vacancy and market activity on site for the type of development proposed)	This is a level site adjacent to the partially developed Fernwood Business Park with good visibility from the adjacent A1. It would be attractive to a range of occupiers.	Good
Strategic Fit with Growth Area Objectives (by target Market Segment)	This site has potential to accommodate key industrial growth sectors as identified in the D2N2 Vision 2030 document.	Average
OVERALL SITE RATING	Very Good	
Recommendation and Potential Future Uses	Allocate for employment uses i.e. retain strategic site allocation (Land around Fernwood – NAP 2C) for Use Class E office development However, in reality, it is unlikely that the whole site will come forward for Use Class E office development and there is likely to be an element of mixed-use development, the following possible alternative uses could be considered:	

	<ul style="list-style-type: none"> • Uses within Use Class E- Commercial, Business and Service, although the Council may wish to exclude Class E(a) retail; • Class C1 Hotels; • Class C2 Residential Institutions; • Class F1 Learning and Non-Residential Institutions; • Specific Sui-generis uses e.g. Public Houses/ Drinking Establishments with Expanded Food Provision (formerly Class A4) and Hot Food Takeaways (formerly Class A5). <p>It is not the purpose of this study to determine the split of these uses.</p>
--	--

SITE SUMMARY:

This is an undeveloped grassland site immediately south of Fernwood Business Park and adjacent to the A1. It is immediately to the east of the Middlebeck sustainable urban extension. There is no vehicular access to the site but there is potential access from an extension of the existing access stub road to the north of the site. This site has potential to accommodate key industrial growth sectors and would likely be attractive to a range of occupiers. It is recommended that the site is allocated for employment uses, i.e. the strategic site allocation (Core Strategy, 2019) for is retained for development of the site for use class E offices. However, in reality, it is unlikely that the whole site will come forward for Use Class E office development and there is likely to be an element of mixed-use development.

ShAP 4 Land at Thoresby Colliery (Ref: NSDC25)



**GROSS SITE AREA:
8.40 ha**

**ESTIMATED NET DEVELOPABLE AREA:
3.24 ha**
*(Note: based on proposed employment floorspace
planning permission ref. 16/02173/OUTM)*

CRITERIA	COMMENT	RATING
<p>Site Context</p> <ul style="list-style-type: none"> • Location with regards to existing employment areas and other sites • How the site fits into the overall portfolio 	<p>This site is part of the wider former Thoresby Colliery site which is being redeveloped by Harworth Group. The wider development will comprise of 800 new homes accompanied by a local centre, primary school, leisure facilities, a 350-acre country park and a 25-acre business park. The first phase known as 'Thoresby Vale' is being delivered by Harron Homes, and construction has commenced.</p> <p>The site is approximately 7km north east of the former Clipstone Colliery site, now allocated as a mixed-use site.</p>	
<p>Local Plan Designation</p>	<p>The Development Plan for the District comprises of the Amended Core Strategy (adopted 7th March 2019) and Allocations & Development Management (adopted 16 July 2013) Development Plan Documents. The site is allocated as ShAP4 (Core Strategy 2019) a strategic site for housing (in the region of 800 dwellings); employment land uses (B uses: 10 hectares); a community centre, comprising leisure and community uses along with retail to meet local needs; and associated green, transport and other infrastructure. The distribution of proposed uses is indicatively illustrated within the Core Strategy (see below), and this site is identified for commercial development alongside green infrastructure and landscape buffers.</p>	

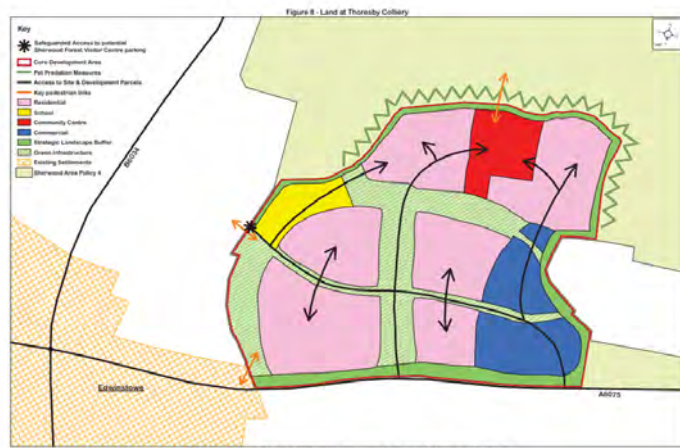

The site is not included within the Edwinstowe Conservation Area.

To the immediate east of the site is land designated by Public Open Space/School Playing Fields (protected by Spatial Policy 8) and National Nature Reserves.

The majority of the site is also contained in the village envelope but excludes the rectangular eastern portion of the site (Edwinstowe Policy Map – Inset Map 9).

Status in SHLAA

N/A

Planning History

- Recent planning history includes:
- 20/02488/RMAM - Reserved matters for the phase 3 - phase 9 enabling infrastructure works and conditions attached to permission 16/02173/OUTM.
 - 20/01908/DISCON - Discharge of conditions attached to planning permission 16/02173/OUTM in respect of Phase 2 Residential Development up to 800 dwellings (Class C3), Strategic Employment Site comprising up to 4,855 sqm Class B1a, up to 13,760 sqm Class B1c, and up to 13,760 sqm Class B2, a new Country Park, a Local Centre, "The Heart of the New Community" containing a mix of leisure (to include zip wire), commercial, employment, community, retail (up to 500 sqm), health, and residential uses, a Primary School, Open Space and Green Infrastructure (including SUDS), and associated access works including the details of the primary access junctions into the site from Ollerton Road.
 - 19/00674/RMAM - Submission of reserved matters for the first phase enabling infrastructure works, comprising a new ghost island junction on Ollerton Road, a new main Spine Road connecting through the development site, and associated highway drainage, together with surface and foul water infrastructure drainage systems, remediation, landscaping and earthworks, ecology, lighting and new roads together with Air Quality Monitoring for the whole site (Conditon 20)

- 19/02284/DISCON – Discharge of conditions related to Phase 1 and attached to planning permission 16/02173/OUTM
- 19/01116/DISCON - Discharge of conditions attached to planning permission 16/02173/OUTM
- 19/01117/DISCON - Discharge of conditions attached to planning permission 16/02173/OUTM
- 16/SCR/00009 - Proposed mixed uses including residential, employment and recreational uses
- 16/02173/OUTM - Residential Development up to 800 dwellings (Class C3), Strategic Employment Site comprising up to 4,855 sqm Class B1a, up to 13,760 sqm Class B1c, and up to 13,760 sqm Class B2, a new Country Park, a Local Centre, "The Heart of the New Community" containing a mix of leisure (to include zip wire), commercial, employment, community, retail (up to 500 sqm), health, and residential uses, a Primary School, Open Space and Green Infrastructure (including SUDS), and associated access works including the details of the primary access junctions into the site from Ollerton Road. Approved Masterplan is included for reference below).



Current Use and Land Type

This is a former colliery site. The northern area is now a cleared development site and the southern area is grassland.

Occupier Profile
(if partly developed, including % of available land and levels of vacancy onsite)

This site comprises of a cleared development site to the north and grassland to the south.

Strategic Road Access

The A614 and A616 are approximately 1.3 km to the west and can be accessed via Ollerton Road. It adjoins the A6075 to the south.

Average

Local Road Access

There is no existing vehicular access to this site at present, albeit it is adjacent to Ollerton Road (A6075). Ollerton Road is a good free-moving road. Access roads are proposed as part of the

Average

	wider Thoresby Vale development.	
Proximity to Urban Areas and Access to Labour and Services (including public transport / cycling / walking accessibility)	<p>The site is approximately 1.2km east of the village of Edwinstowe. Edwinstowe provides a medical practice, convenience stores, a primary school, cafes and takeaways. The site is approximately 2km west of Ollerton which can be accessed via Ollerton Road. Ollerton town provides a range of services and amenities including supermarkets and schools.</p> <p>There are bus stops on Ollerton Road adjacent to the site with regular services to Ollerton, Walesby, Kirton and Mansfield.</p>	Average / Poor
Compatibility of Adjoining Uses (including amenity impacts experienced by current/future occupiers and neighbouring areas)	<p>The site is bound to the north by the wider former colliery site; to the east by Cockglode and Rotary Wood Local Nature Reserve and residential properties; to the south by Ollerton Road with grassland, the River Maun and a water treatment works beyond; and to the west by the wider former colliery site.</p> <p>The approved masterplan for the site shows that the employment uses will be bound by residential properties to the north and west.</p>	Average
Developmental and Environmental Constraints (e.g. size; topography; site access; roads, lighting, landscaping, mains utilities and communications infrastructure; flood risk; contamination; nature and heritage conservation)	<p>This is a relatively level site. There are some hedgerows and trees intersecting the site and along the boundaries.</p> <p>Overhead lines intersect the centre of the site from north to south.</p> <p>A review of Flood Maps for Planning (Gov.uk, 2021) shows the site is not located within a flood zone. However, beyond the A6075 to the south is a designated Flood Zone 3 and 2. There is a drainage pond in the centre of the site.</p> <p>The site is not subject to any listed structures nor are there any within the immediate locality (Historic England Listing Map, 2021).</p> <p>Cockglode and Rotary Wood Local Nature Reserve bounds the site to the east.</p> <p>There is likely to be contamination associated with the former colliery use of the site.</p>	Average
Barriers to Delivery and Mitigation (including ownership constraints - if known)	The constraints and appropriate mitigation are addressed in the planning applications for the redevelopment of the wider site. No other barriers to redevelopment were evident from the site visit.	Good

<p>Market Attractiveness (including appropriateness, vacancy and market activity on site for the type of development proposed)</p>	<p>This site has significant frontage onto Ollerton Road and is being delivered as part of the wider redevelopment of the former colliery. It is identified for development for a mix of uses including employment and is likely to be attractive to a range of occupiers.</p>	<p>Average</p>
<p>Strategic Fit with Growth Area Objectives (by target Market Segment)</p>	<p>This site has the potential to accommodate industries identified as key industrial growth sectors in the D2N2 Vision 2030 document.</p>	<p>Average</p>
<p>OVERALL SITE RATING</p>	<p>Average</p>	
<p>Recommendation and Potential Future Uses</p>	<p>Designate for mixed-uses with employment uses on this site (i.e. retain ShAP4 allocation as a mixed-use strategic site including employment land uses on this site - Core Strategy, 2019)</p>	
<p>SITE SUMMARY:</p>		
<p>This site is part of the wider former Thoresby Colliery site which is being redeveloped by Harworth Group. The wider development will comprise of 800 new homes accompanied by a local centre, primary school, leisure facilities, a 350-acre country park and a 25-acre business park offering up to 250,000 sq ft of employment space. Outline permission, multiple reserved matters permissions and applications to discharge conditions have been granted. The first phase known as ‘Thoresby Vale’ is being delivered by Harron Homes and construction has commenced. This site is identified for development for employment uses in the approved masterplan and is likely to be attractive to a range of occupiers. The site is allocated as a mixed-use strategic site in the Local Plan including an element of office floorspace and it is recommended that the site is allocated for mixed-uses with employment uses on this site.</p>		

CI/MU/1 Former Clipstone Colliery (Ref: NSDC26)



**GROSS SITE AREA:
27.64 ha**

**ESTIMATED NET DEVELOPABLE AREA:
10.8 ha**
(Note: comprising of 12 ha identified for employment within wider mixed-use allocation and a 90% gross to net adjustment applied)

CRITERIA	COMMENT	RATING
<p>Site Context</p> <ul style="list-style-type: none"> • Location with regards to existing employment areas and other sites • How the site fits into the overall portfolio 	<p>This is a former colliery site, the majority of which is now grassland, with just the abandoned headstocks and powerhouse remaining. It is allocated as a mixed-use site with Planning Permission - CI/MU/1, Clipstone – Mixed Use Site 1. It is located within the east of the district, in close proximity to Mansfield and approximately 2.5km west of the Crown Farm Way Industrial Estate.</p>	
<p>Local Plan Designation</p>	<p>The Development Plan for the District comprises of the Amended Core Strategy (adopted 7th March 2019) and Allocations & Development Management (adopted 16 July 2013) Development Plan Documents. The site is allocated as a mixed-use site with Planning Permission (April 2011) (CI/MU/1, Clipstone – Mixed Use Site 1, Allocations & Development Management DPD, 2013). Assuming the retention of the headstocks and powerhouse, the site will accommodate around 120 dwellings, 12 hectares of employment provision, retail and enhanced Public Open Space.</p> <p>The site is also located within a Source Protection Zone 3 (DM10) and immediately borders a Site of Interest in Nature Conservation (Core Policy 12 and DM7) and National/Local Nature Reserve (Core Policy 12 and DM7) to the west.</p> <p>The site is contained within the urban boundary/village envelope (DM1) as defined in the Newark & Sherwood Local Development Framework Policies Map.</p>	

Status in SHLAA	Site Ref: Former Clipstone Colliery (08_0195) for 724 dwellings. The site could be available in 5 years. Information submitted: Phased development of 800 houses and employment on the remainder.	
Planning History	Recent planning history includes: <ul style="list-style-type: none"> • 20/02481/LBC - Demolition of the three-storey conveyor building on the south-western corner of the southerly headstock and the single storey lean-to building on the south-western corner of the northerly headstock • 18/SCR/00010 - Request for a Screening Opinion for retention of Headstocks and power house and erection of approximately 120 No. dwellings and 12 ha of employment provision, retail and enhanced public open space • 16/SCR/00006 - Request for Screening Opinion for development proposal 	
Current Use and Land Type	This is a former colliery site, the majority of which is now grassland, with just the abandoned headstocks and powerhouse remaining.	
Occupier Profile (if partly developed, including % of available land and levels of vacancy onsite)	The majority of the site is undeveloped grassland with just the abandoned headstocks and powerhouse adjacent to Mansfield Road remaining.	
Strategic Road Access	The A60 is approximately 5.5 km to the west via the B6030 and New Mill Lane and the A614 is approximately 6.5km to the east via the B6030.	Poor
Local Road Access	The site can be accessed from Mansfield Road (B6030) on the northern boundary. This is a good free-moving road albeit passing through residential areas.	Good
Proximity to Urban Areas and Access to Labour and Services (including public transport / cycling / walking accessibility)	The site is located within the settlement of Clipstone which has a range of local shops, schools and a medical centre. The site is approximately 6.5 km east of the centre of Mansfield. There are bus stops of Mansfield Road adjacent to the site with services to Mansfield, Walesby and Kirton. National Cycle Route 6 runs along the site's southern boundary.	
Compatibility of Adjoining Uses (including amenity impacts experienced by current/future occupiers and neighbouring areas)	The site is bound to the north by Mansfield Road with residential properties beyond; to the east by residential properties and industrial workshops; to the south by grassland, Vicar Water and National Cycle Route 6 and a disused railway line beyond, with Clipstone Forest and Sherwood Forest further to the south; and to the west by	

	residential properties, Vicar Water Local Nature Reserve, Clipstone Heath SSSI and Sherwood Forest Golf Course SSSI beyond.	
Developmental and Environmental Constraints (e.g. size; topography; site access; roads, lighting, landscaping, mains utilities and communications infrastructure; flood risk; contamination; nature and heritage conservation)	<p>This is a large relatively level site.</p> <p>A review of Flood Maps for Planning (Gov.uk, 2021) shows the site is not located within a flood zone. However, Vicar Water, passes the site along the eastern border is designated as a Flood Zone 3.</p> <p>The site contains a Grade II Listed Building (Headstocks and Powerhouse) (Historic England Listing Map, 2021).</p> <p>There are a number of environmental designations adjacent to the site.</p>	Average / Poor
Barriers to Delivery and Mitigation (including ownership constraints - if known)	The remaining headstocks and powerhouse are Grade II listed and due to the former colliery use of the site there are potential contamination issues. There are potential flood issues associated with Vicar Water to the south of the site. Any redevelopment of the site would need to assess impact upon and mitigate against harmful effects on the adjoining environmental designations. Impact upon the amenity of neighbouring residential uses would also need to be considered.	Poor
Market Attractiveness (including appropriateness, vacancy and market activity on site for the type of development proposed)	This is a larger relatively level site within Clipstone and with significant frontage onto Mansfield Road. However, there are a number of significant constraints to redevelopment relating to the former colliery use, the Grade II listed buildings onsite, the adjacent environmental designations and flood risk onsite. Subject to overcoming these constraints, the site is likely to be attractive for mixed-use development.	Average
Strategic Fit with Growth Area Objectives (by target Market Segment)	This site has potential to accommodate industries identified as key industrial growth sectors in the D2N2 Vision 2030 document.	Average
OVERALL SITE RATING	Average / Poor	
Recommendation and Potential Future Uses	Designate for mixed-use with an element of employment uses on this site. (i.e. retain allocation as a mixed-use site - CI/MU/1 Clipstone Mixed Use Site 1 (Allocations & Development Management DPD, 2013), including 12 ha (gross) for employment)	
SITE SUMMARY:		
This is a former colliery site, the majority of which is now grassland, with just the abandoned headstocks and powerhouse (Grade II Listed) remaining. It is allocated as a mixed-use site with		

Planning Permission - CI/MU/1, Clipstone – Mixed Use Site 1. It is located within the east of the district, in close proximity to Mansfield and approximately 2.5km west of the Crown Farm Way Industrial Estate. There are a number of significant constraints to redevelopment relating to the former colliery use, the Grade II listed buildings onsite, the adjacent environmental designations and flood risk onsite. Subject to overcoming these constraints, the site is likely to be attractive for mixed-use development. It is recommended that the site is allocated for mixed-use, including 12 ha gross for employment uses.

Glaisdale (Ref: NCC1)



**GROSS SITE AREA:
42.63 ha**

**ESTIMATED NET DEVELOPABLE AREA:
2.93 ha
(vacant plots)**

CRITERIA	COMMENT	RATING
<p>Site Context</p> <ul style="list-style-type: none"> • Location with regards to existing employment areas and other sites • How the site fits into the overall portfolio 	<p>The site is located within the outer Nottingham suburb of Bilborough, a predominately residential area with a number of schools and colleges, Bilborough Medical Centre and local shopping facilities such as Co-op Food and Asda.</p> <p>Nottingham Business Park is located approximately 3.4 km to the north of Glaisdale and c.6.7 km to the west of Nottingham City Centre.</p>	
<p>Local Plan Designation</p>	<p>The site is allocated within the Nottingham City Local Plan as a Major Business Park/Industrial Estate (Local Plan Policy EE2).</p> <p>The site is also located within an Air Quality Management Area (Local Plan Policy IN2) and a Mineral Safeguarding Area (Local Plan Policy MI1). Proposed cycle route improvements are allocated along Wigman Road (Local Plan Policy TR3).</p> <p>Allocated allotments are also designated near the central area of the site, but outwith the employment area boundaries (Plots 83, Local Plan Policy EN4). To the immediate east of the site is a proposed cycle route (Bilborough to City, Local Plan Policy TR3). To the south-east of the site, an allocation for housing is also designated for 110 dwellings (SR29).</p>	
<p>Status in SHLAA</p>	<p>N/A</p>	
<p>Planning History</p>	<p>Recent planning history includes;</p> <ul style="list-style-type: none"> • 19/00697/PFUL3 – Full planning application – Two storey side extension, single storey front and rear extension, dormer to rear – Granted (10 August 2020) 	

	<ul style="list-style-type: none"> 20/00855/PFUL3 – Full planning application – Erection of new industrial warehouse unit with ancillary offices (Use Classes B2 and B8) associated service yards, parking, landscaping, reconfiguration of site access points, relocation of existing bus stop and alteration to on-street parking zones. 	
Current Use and Land Type	<p>The site consists of a series of industrial units and courts with some of the buildings including ancillary car parking facilities. The buildings are of a mixed type including small and large industrial units, some with office facilities and areas of vacant brownfield land. The site includes premises operating within class D2, E, B2, B8 and Sui Generis uses.</p> <p>The buildings are generally in good/very good conditions, dating from the 1990s to modern premises.</p>	
Occupier Profile (if partly developed, including % of available land and levels of vacancy onsite)	<p>Occupiers of the site include: Eight Days a week print solutions, Kingston Communications, Amari Digital Supplies, Habasit (UK) Ltd, Sprite Labels Ltd, Moldex Metric AG & Co KG, Art Systems, Bosch, Alton Cars, FXD Fitness, British Red Cross (Community Equipment Services), ACORN Trade Windows and Doors, Agilitas Central Dry Cleaners, F Tawse Ltd., ASM, Wollaton Gate & Fabrications, Excel, Goldfish, The Royal Logistic Corps (162 Regiment), Army Reserve Centre, AAA Gearboxes, Drain Scan Limited, M.S.M Hygiene Ltd., Nottingham Industrial Cleaners Ltd., Webuyanycar.com, Kendon Packaging Group plc., Willbond Plumbing Heating Bathrooms, Taylors Transport Group UK & International Haulage Storage and Distribution, Worktop Fabrications, Hillarys, Royal Mail, and Blue Whale Spa.</p> <p>Less than 5% of the site is vacant with 1 unit available at Glaisdale Point, 2 at Parkway Court and two small areas of brownfield land for development within the central area of the site and to the east, approximately 2.93ha in developable space. The site (0.86ha) has received planning permission for build to suit industrial/warehouse up to 100,000 sq. ft. (ref. 20/00855/PFUL3).</p>	
Strategic Road Access	The site is readily accessible to the A609 to the south and joins the M1 approximately 4.5km to the east.	Average / Poor
Local Road Access	The site is accessed along its northern end along Glaisdale Drive East and Glaisdale Drive West. The roads also serve the adjoining residential area to the north. Part of the site is accessed from Wigman Road, along the sites north-east boundary.	Average / Poor

	<p>Glaisdale Drive West connects to the A609 via a traffic light junction. Access to Glaisdale Drive East is difficult as a consequence of a four-armed mini roundabout on Wigman Road.</p>	
<p>Proximity to Urban Areas and Access to Labour and Services (including public transport / cycling / walking accessibility)</p>	<p>Located within the outer Nottingham suburb of Bilborough, the site connects to the wider area via excellent pedestrian infrastructure.</p> <p>The site is very well served by public transport, benefiting from multiple bus stops throughout the site. The buses provide a regular service to Assarts Farm, Beechdale and Nottingham City Centre.</p> <p>Parking is permitted along Glaisdale Drive West and Glaisdale Drive East but is restricted to permit holders, card holders (3GP) or at a charge between 9:00-17:00, Monday – Friday.</p> <p>Overall, the site has limited cycle infrastructure; however, a designated cycle lane runs along Wigman Road with both Glaisdale Drive West and Glaisdale Drive East wide enough to safely accommodate cyclists.</p>	<p>Very Good</p>
<p>Compatibility of Adjoining Uses (including amenity impacts experienced by current/future occupiers and neighbouring areas)</p>	<p>The site neighbours' residential areas on all compass trajectories. The site is also bound by an active train line along its entire southern boundary and approximately 3.1 ha of allotments are located in the centre of the site.</p>	<p>Very Poor</p>
<p>Developmental and Environmental Constraints (e.g. size; topography; site access; roads, lighting, landscaping, mains utilities and communications infrastructure; flood risk; contamination; nature and heritage conservation)</p>	<p>The site is one of the largest employment areas in Nottinham. Glaisdale forms a long and relatively wide strip of industrial units and courts that follow the curving Glaisdale Drive East and Glaisdale Drive West roads.</p> <p>Glaisdale Drive East gradually inclines to the west with access from Wigman Road to Glaisdale Drive East made difficult as a consequence of a 4-armed mini round about.</p> <p>As the site is located immediately opposite an established residential area, the site benefits from good levels of lighting along the pavements.</p> <p>A review of Flood Maps for Planning (2021) and Historic England's listing map (2021) indicates that the site is not at risk of flooding and nor does it contain any listed buildings.</p>	<p>Good</p>
<p>Barriers to Delivery and Mitigation (including ownership constraints - if known)</p>	<p>The site is located within an Air Quality Management Area (Local Plan Policy IN2) and a Mineral Safeguarding Area (Local Plan Policy MI1).</p>	<p>Average</p>

<p>Market Attractiveness (including appropriateness, vacancy and market activity on site for the type of development proposed)</p>	<p>Two areas of brownfield land are available for development within the site. The central plot of land measures c.0.64 ha, the site has a sloping drive access but is generally regular in shape and level in appearance with concreted foundations covered in natural vegetation.</p> <p>The larger vacant area of land (c.2.3 ha) located to the east of the site is promoted by JLL, who are marketing the site for build to suit industrial/warehouse units up to 100,000 sq. ft.) (ref. 20/00855/PFUL3).</p> <p>The site was the former Former Chromoworks Ltd site (JLL) and is owned by industrial developer Sladen. Prior to acquisition of the land by Sladen, the initial marketing period saw a significant level of <i>“interest from developers and property funds who clearly realised the importance of the site and regarded it as a valuable development opportunity”</i> (NG Chartered Surveyors)</p> <p>A blue-chip company had shown interest in moving to the site and occupying 80% of the land leaving enough space for a small retailer to occupy the rest. According to NG Chartered Surveyors, the deal fell through.</p>	<p>Good</p>
<p>Strategic Fit with Growth Area Objectives (by target Market Segment)</p>	<p>The following industrial growth sectors are already located within the site:</p> <ul style="list-style-type: none"> • Creative & Digital • Logistics & E-Commerce <p>The site is located within the Nottingham ‘<i>Regional Centre</i>’ (as identified in the D2N2 Vision 2030 document).</p>	<p>Good</p>
<p>OVERALL SITE RATING</p>	<p>Good</p>	
<p>Recommendation and Potential Future Uses</p>	<p>Allocate for employment uses</p> <p>Retain current Local Plan designation as a major business park/industrial estate</p> <p>The site is an established industrial site with notable development opportunities and limited vacancies. The planning history of the site reflects continued interest in the site, specifically in developing future employment premises. The opportunities and planning permissions (ref. 20/00855/PFUL3) themselves have attracted the attention of a blue-chip organisation. The site is also located within Nottingham’s ‘Regional Centre’.</p>	
<p>SITE SUMMARY:</p>		

The site is located within the outer Nottingham suburb of Bilborough approximately 6.69km to the west of the city centre. The site is also relatively close to Nottingham Business Park, c. 3.4km to the north. Glaisdale consists of a series of industrial units and courts containing a mix of business premises defined within class **D2, E, B2, B8 and Sui generis** uses. Occupiers include The Royal Logistic Corps (162 Regiment) and Army Reserve Centre.

Glaisdale has two vacant areas of developable brownfield land equating to a combined total of c. 2.9 ha. Planning permission has been approved for B2/B8 industrial warehouse unit with ancillary offices. The marketing agent is promoting the site for build-to-suit industrial/warehousing of up to 100,000 sq. ft. The development opportunity has already received attention from a blue-chip organisation. Given the site is located within the 'Regional Centre' of Nottingham, is an established site and the planning and marketing history of the site indicates ongoing interest in the site for employment uses, the site should retain its allocation as a Major Business Park/Industrial Estate, and it is recommended to allocate the site for employment uses.

Blenheim (Ref: NCC2)



**GROSS SITE AREA:
40.81 ha**

**ESTIMATED NET DEVELOPABLE AREA:
7.05 ha**

CRITERIA	COMMENT	RATING
<p>Site Context</p> <ul style="list-style-type: none"> • Location with regards to existing employment areas and other sites • How the site fits into the overall portfolio 	<p>The site is located on the north-east edge of Bulwell, approximately 13.2 km north-west of Nottingham City Centre.</p> <p>To the immediate north-west of the site is Blenheim Court, with two large industrial units occupied by DPD UK and The Health Store. Further to the north across the City boundary into Ashfield District is Hucknall Aerodrome and the very large Rolls-Royce manufacturing plant. The site is also in close proximity to Greasley Street industrial area and Stanton Tip to the south-east.</p>	
<p>Local Plan Designation</p>	<p>The site is allocated within the Nottingham City Local Plan as a Major Business Park/Industrial Estate (Local Plan Policy EE2). The site is also located within a Mineral Safeguarding Area (Policy MI1) and an Air Quality Management Area (Local Plan Policy IN2). A large area of grassed farmland within the boundary is allocated for further employment use (Local Plan Policy SA1) comprising of 4,800 sqm. of office floorspace and 2ha of industrial or warehouse units.</p> <p>To the north-east of the site, Blenheim borders Blenheim Lane Allotments (Plots 123, Local Plan Policy EN4), with open space designations to the west. Proposed cycle route improvements are designated parallel with the site along the A6002 (Local Plan Policy TR3).</p>	
<p>Status in SHLAA</p>	<p>N/A</p>	
<p>Planning History</p>	<p>Recent planning history includes;</p> <ul style="list-style-type: none"> • 15/00893/PVAR3 – S.73 application – Energy from waste facility (160,000 tonnes of waste per annum capacity), manufacturing, research and development facility and associated offices. (Revised design S.73 	

	application to vary condition S1 of planning permission reference 13/03051/PMFUL3) – Granted 31.07.15	
Current Use and Land Type	The site consists of a series of industrial courts and Business Parks, with some large to medium sized standalone industrial units. The buildings are in a good condition, constructed around the late 1990s and early to late 2000s. The site is occupied by a mix of business premises, classified within Class E, B2, B8 and Sui Generis uses.	
Occupier Profile (if partly developed, including % of available land and levels of vacancy onsite)	<p>Occupiers of the site include:</p> <p>Aspect Business Park – Aspect Business Centre, Homeserve, NHS Nottingham City, SLR Consulting, Marks & Spencer, Homes by Gleeson, The PX Hub</p> <p>Marlborough Court - Grain Sewing Machines, Magic Bullet, Brookair Danfab (Ventilation & Air Conditioning) and Cool Repair.</p> <p>Martin Court – Central Colour Ltd, Ridge & Tyler (packaging company), Print & Display Ltd, Sankey Ltd, SOL Construction, NBC Print Finishing, S & W Cutting Formes Nottingham Ltd, B3 Cricket Ltd and DFB Sound & Light.</p> <p>Bennerley Court – Wilson Driveshafts Co., Principal Contracting Ltd., Pendeque Distributions, Alert Electrical Wholesalers Ltd., Outback Interiors Ltd, Gateway Finishers, Peatman & Cox, The Peter Smith Valve Co., Sparks Mechanical Service. Ltd, East Midlands Roofing College, Nottingham Saab, Panton Mcleod Ltd and Nottingham Autotechnik Ltd.</p> <p>Centurion Business Park – Premier Tech Chronos Ltd, Skynet Woldwide Deltec International, Hubergroup (UK) Limited, Bartec Vodec Limited, Plastics Plus Limited and Shred-It Limited</p> <p>DHL, SGS (Precision instrument calibration), Budget Greeting Cards Ltd, Renault Trucks / RH Commercial Vehicles, Omega, Micro Mesh Paul White Wholesales, Red Kangaroo Trampoline Parks Great Bear Distribution Centre, Milk & More Nottingham Fulfilment Centre, AFI Uplift Ltd., Batleys Cash & Carry, Nottingham City Council Vehicle Compound, Batley’s Cash and Carry, Asda.com Distribution Centre</p> <p>7.05 ha of undeveloped land (neighbouring the allotments and golf course) within the site is advertised for commercial development (Property Plus).</p> <p>Several units and office space are also vacant; however, this equates to approximately <5-10% of the site.</p>	
Strategic Road Access	The site adjoins the A6002 along the eastern	Average / Good

	border. The A6002 connects the site to the M1 (at Nuthall Interchange), approximately 1.6 km to the south-west.	
Local Road Access	<p>The primary access to the site is off a four-armed roundabout along the A6002, connected by a short segment of road – Seller’s Wood Drive – onto a second four-armed roundabout, avoiding the neighbouring residential area.</p> <p>The north-east part of the site is directly accessible via a roundabout on the A6002.</p>	Very Good
Proximity to Urban Areas and Access to Labour and Services (including public transport / cycling / walking accessibility)	<p>The site is located on the north-eastern edge of Bulwell and is accessible to the wider area via good pedestrian infrastructure. An Aldi foodstore neighbours the site to the south-east, with Bulwell itself having eatery and retail facilities including Tesco Extra, Lidl and Weatherspoons, approximately 1.5km to the east.</p> <p>The site has no cycle infrastructure; however, a shared pedestrian cycleway is designated along Seller’s Wood Drive, following the A6002 in both directions.</p> <p>The site is also serviced by multiple bus stops on Bennerley Road and Dabell Avenue, with services to Nottingham and Snape Wood. Bulwell itself has additional public transport facilities, including Bulwell train station and Bulwell Tram stop. The station connects Bulwell to Worksop and Nottingham with the trams servicing Hucknall and Toton Lane.</p>	Good / Very Good
Compatibility of Adjoining Uses (including amenity impacts experienced by current/future occupiers and neighbouring areas)	Located at the north-east edge of Blenheim the site neighbours a residential area to the south, allotments to the north-west and Bulwell Hall Golf Course and Country Park and Hucknall Aerodrome to the north.	Poor / Average
Developmental and Environmental Constraints (e.g. size; topography; site access; roads, lighting, landscaping, mains utilities and communications infrastructure; flood risk; contamination; nature and heritage conservation)	<p>The site is one of the largest employment areas within Nottingham City.</p> <p>Blenheim Lane divides the site into two segments, with access to both segments of the site accessible from roundabouts off the A6002.</p> <p>A review of Flood Maps for Planning (Gov.uk, 2021) shows the central area of the site is designated within Flood Zone 3.</p>	Poor

	The site does not contain any listed buildings; however, to the north of the site, Blenheim borders 'Blenheim Farmhouse and attached barn' and 'stable at Blenheim Farmhouse' which are both Grade II listed (Historic England Listing Map, 2021).	
Barriers to Delivery and Mitigation (including ownership constraints - if known)	The site is located within a Mineral Safeguarding Area (Policy MI1) and an Air Quality Management Area (Local Plan Policy IN2)	Average
Market Attractiveness (including appropriateness, vacancy and market activity on site for the type of development proposed)	<p>There are several premises advertised for sale/to let on the site, these include:</p> <ul style="list-style-type: none"> • Office Suite 4 and Office Suite 5 and 6 Aspect Business Park to let. Modern business accommodation within a secure business environment benefiting from 24-hour security 365 days a year and gated entrance (3,133 sq. ft. and 4,000-8392 sq. ft.) (CPP Commercial Property Partners). • Martin Court Unit 1, light industrial space with large office and meeting rooms (rent £82,500 p.a. / £6,875 pcm for 14,948 sq. ft.) (Property Plus). • Martin Court Unit 5, light industrial unit in a slightly tired condition, with office (rent £34,000 p.a. / £2,833 pcm for 525 sq. m.) (Property Plus). • Martin Court Unit 6, light industrial unit in a slightly tired condition, (rent £34,00 p.a. / £2,833 pcm for 525 sq. m.) (Property Plus) • Bennerley Court Units 11, 12, 14 are vacant but no advertisement sign. • Unit 1 Dabell Avenue, 38,210 sq. ft. (at £5.50 per sq. ft.) industrial unit set within a secure gated site. The property has a steel frame structure with sheet metal clad elevation. The building has an open span warehouse complete with two storey office accommodation. The property has external parking designated for staff/visitors (36 spaces) and loading/unloading or trailer storage. • Land at Firth Way for sale, 7.05ha commercial development land. The site has permission for an Energy from Waste facility (see ref. 15/00893/PVAR3) and invites unconditional offers with a guide price of £4.5million for the freehold. The site is to be sold by informal tender with offers due 12 noon Monday 7th December 2020 (Property Plus). 	Good

	Across the marketing material, the site is praised for its excellent transport connections with an established and successful industrial area.	
Strategic Fit with Growth Area Objectives (by target Market Segment)	<p>The following industrial growth sectors are already located within the site;</p> <ul style="list-style-type: none"> • Creative & Digital • Visitor Economy • Logistics & E-commerce • Retail • Professional/Business Service <p>The site is located within the Nottingham 'Regional Centre' (as identified in the D2N2 Vision 2030 document).</p>	Very Good
OVERALL SITE RATING	Good	
Recommendation and Potential Future Uses	<p>Allocate for employment uses</p> <p>Retain current Local Plan Designation as a Major Business Park/Industrial Estate</p> <p>The site is an established industrial estate with a breadth of businesses in occupation whom have strong brand identities such as Marks and Spencer, ASDA and the NHS. The planning history of the site shows continued interest in the site, specifically in developing future employment premises with a sustainability focus.</p> <p>The designation does not include the industrial units to the north of the site as this is in Ashfield District's boundary. The area is recently developed, described as containing successful warehouse and logistics premises, and now in its final phase has 3 plots available to buy or rent new build, bespoke, industrial or warehouse units between 18,000 sq. ft. to 70,000 sq. ft (Wilson Bowden Developments, FHP, CPP Commercial Property Partners).</p>	
SITE SUMMARY:		
<p>The site is located on the north-east edge of Bulwell, approximately 13.2km north-west of Nottingham City Centre. Blenheim consists of a series of industrial courts and Business Parks, with some large-to-medium sized standalone industrial units in occupation. The site contains a mix of business premises defined within class E(c) (ii), E(c) (iii), E(g) (i), E(g) (ii), E(g) (iii), B2, B8 and Sui Generis uses. The occupiers include national brands such as Marks & Spencer and NHS Nottingham City. Planning permission has been approved for an Energy from Waste facility on vacant land to the north-east of the site (ref. 15/00893/PVAR3) showing ongoing interest in the site.</p> <p>The site should retain its current Local Plan Designation as a Major Business Park/Industrial Estate and the current employment land allocation SA1, and it is recommend to allocate the site for employment uses.</p>		

Phoenix Park (Ref: NCC3)

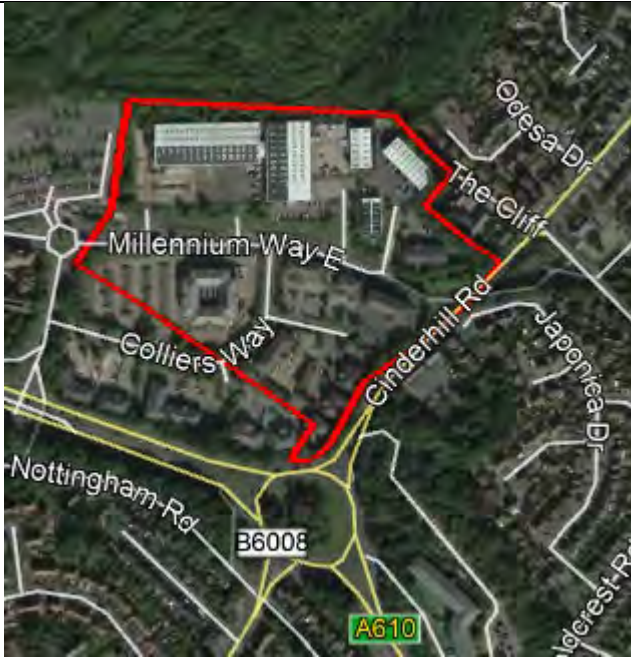

**GROSS SITE AREA:
7.13 ha**

**ESTIMATED NET DEVELOPABLE AREA:
0 ha**

CRITERIA	COMMENT	RATING
<p>Site Context</p> <ul style="list-style-type: none"> • Location with regards to existing employment areas and other sites • How the site fits into the overall portfolio 	<p>The site is located within the suburbs of north-west Nottingham, with access to the M1 approximately 1.0km to the west. The site benefits from a Park & Ride to the immediate west of the site adjoining Phoenix Park Tram Stop providing regular services to the City Centre, seven days a week.</p> <p>The business park adjoins Stanton Tip to the north and Greasley street beyond.</p>	
<p>Local Plan Designation</p>	<p>The site is located at the western edge of the Nottingham City Council unitary boundary, bordering Broxtowe Borough. The site is allocated within the Nottingham City Local Plan as a Major Business Park/Industrial Estate (Local Plan Policy EE2). The site is also located within an Air Quality Management Area (Local Plan Policy IN2) with the Mineral Safeguarding Area marginally encroaching along the south-west boundary.</p> <p>To the east of the site, is the Cinderhill Archaeological Constraint Area (Local Plan Policy HE1) which slightly infringes along the eastern border.</p> <p>To the north of the site is an area of land allocated for mixed-use development at Stanton Tip including 350 dwellings and 5-10 ha of industrial units or warehousing (Local Plan Policy SA1).</p>	
<p>Status in SHLAA</p>	<p>N/A</p>	

Planning History	No recent planning history to note.	
Current Use and Land Type	The site is a modern business park with excellent transport connectivity. The business premises operating on the site consist of class E and B8 uses . The office buildings occupying the site are predominantly modern red brick detached office blocks with ancillary parking. Having recently been constructed in the early 2000s they are in a very good condition. Two industrial units are also located in the site, one with an extensive footprint, again these are both in a very good condition.	
Occupier Profile (if partly developed, including % of available land and levels of vacancy onsite)	<p>Occupiers of the Park include:</p> <p>Michael Pavis Ltd Merchants to the Plumbing & Heating Trades Clip'n Climb Avant Homes E.on National Education Union Daisy Group The Guide Dogs for the Blind Association</p> <p>Resource House (a newly refurbished, self-contained, grade A office building) is advertised as being to let and marketed by FHP.</p>	
Strategic Road Access	The site adjoins the A610, which connects the site to the M1, approximately 1.8 km to the west.	Good / Average
Local Road Access	Transit through Colliers Way onto Millennium Way, adjoining a 3-armed roundabout.	Very Good
Proximity to Urban Areas and Access to Labour and Services (including public transport / cycling / walking accessibility)	<p>The site is located within the suburbs of north-west Nottingham, positioned to the north of Cinderhill and west of Bulwell. Both areas contain retail and food premises within easy walking distance from the site. The site is also accessible via cycling infrastructure forming part of the road network.</p> <p>The site benefits from the Phoenix Park tram stop that provides regular services to the City Centre seven days a week. The adjoining Park & Ride also has cycle parking and EV charging points. Bulwell train station is located to the north-east of the site, an approximately 15-minute walk. The station provides services to Nottingham, Worksop and Mansfield Woodhouse.</p>	Very Good
Compatibility of Adjoining Uses	The site is constrained by Cinderhill Road to the east and a residential area to the north-east.	Average

(including amenity impacts experienced by current/future occupiers and neighbouring areas)		
Developmental and Environmental Constraints (e.g. size; topography; site access; roads, lighting, landscaping, mains utilities and communications infrastructure; flood risk; contamination; nature and heritage conservation)	<p>The site forms a patchwork designation with the adjoining employment area forming Phoenix Park. The site is easily accessible from the A610, with a designated lane for turning into the site and a traffic light junction for exit from the park. The site follows a one-way system heading east along Millennium Way and onto Colliers Way.</p> <p>The tramline itself cuts through the site, running parallel with Millennium Way east.</p> <p>A large area of the site is located within a Flood Zone 3 designation, with some areas in Flood Zone 2 (Flood Map for Planning – Gov.uk, 2020).</p>	Poor / Average
Barriers to Delivery and Mitigation (including ownership constraints - if known)	The site is located within an Air Quality Management Area (Local Plan Policy IN2) with the Mineral Safeguarding Area marginally encroaching along the south-west boundary.	Good
Market Attractiveness (including appropriateness, vacancy and market activity on site for the type of development proposed)	<p>5 Phoenix Place is advertised as a fully let office investment opportunity on the ‘established Phoenix Business Park’ with good levels of onsite parking and transport connectivity (FHP).</p> <p>The office comprises 6,093 sq. ft. at an asking price of £1,000,000. The marketing material indicates that the office space will be sold with a tenant in occupation, generating £79,500 per annum. The property has a net initial yield of 7.52% and potential reversionary yield of 8.35% (FHP).</p>	Very Good
Strategic Fit with Growth Area Objectives (by target Market Segment)	<p>The following industrial growth sectors are already located within the site:</p> <ul style="list-style-type: none"> • Creative & Digital • Visitor Economy • Retail • Health/Social Care • Professional/Business Service <p>The site is located within the Nottingham ‘Regional Centre’ (as identified within the D2N2 Vision 2030 document).</p>	Very Good
OVERALL SITE RATING	Very Good	
Recommendation and Potential Future Uses	<p>Protect for employment uses</p> <p>Retain current Local Plan Designation as a Major Business Park/Industrial Estate</p>	

	<p>The site is fully occupied with good transport connectivity. Phoenix Park offers modern office premises and is located within the Nottingham 'Regional Centre'.</p>
--	--

SITE SUMMARY:

The site is located within the suburbs of north-west Nottingham, positioned to the north of Cinderhill and west of Bulwell. The site is occupied by modern office complexes with two industrial units on site -Michael Pavis Ltd Merchants to the Plumbing & Heating Trades is a particularly large unit. All are of a modern build and in a very good condition.

The site has good levels of transport connections with multi-modal choices for commuters including tram, railway or car. Vehicles accessing the business park are only 1km away from the M1. The site is fully occupied and located within the Nottingham 'Regional Centre'. Given the above characteristics the site should retain its employment designation as a Major Business Park/Industrial Estate, and it is recommended to protect the site for employment uses.

Greasley Street (Ref: NCC4)



**GROSS SITE AREA:
11.19 ha**

**ESTIMATED NET DEVELOPABLE AREA:
0 ha**

CRITERIA	COMMENT	RATING
<p>Site Context</p> <ul style="list-style-type: none"> • Location with regards to existing employment areas and other sites • How the site fits into the overall portfolio 	<p>The site is located within Bulwell, approximately 11.3km north-west of Nottingham city centre.</p> <p>The site is situated within a predominately residential area, with Stanton Tip further to the south and Phoenix Park beyond. Greasley Street is also in close proximity to Blenheim, with Rolls Royce and Hucknall Aerodrome further to the north.</p>	
<p>Local Plan Designation</p>	<p>The site is allocated within the Nottingham Local Plan as a Major Business Park / Industrial Estate (Local Plan Policy EE2) and is located within an Air Quality Management Area (Local Plan Policy IN2) and partly within a Mineral Safeguarding Area (Local Plan Policy MI1). The Bulwell Conservation area is also located to the immediate east of the site</p> <p>An area of Open Space (Catherine Close, Local Plan Policy EN1 and land next to Bulwell BMX Track) are allocated to the north and west of the site, with Local Geological Sites (Muster Street Walk Quarry, Local Plan Policy EN6) also allocated to the north.</p>	
<p>Status in SHLAA</p>	<p>Site ID: 651, overall conclusion: not deliverable or developable.</p>	
<p>Planning History</p>	<p>No recent planning history of note.</p>	
<p>Current Use and Land Type</p>	<p>The site consists of a number of industrial units and buildings in a relatively poor and tired condition. The buildings are dated around the late 1980s and early 1990s. The occupants of the site are classified within class E, B2 and Sui Generis uses.</p>	

<p>Occupier Profile (if partly developed, including % of available land and levels of vacancy onsite)</p>	<p>Occupiers of the site include: Frank Key Group (Builders Merchants or Builders Supplies) Eagle Fabrications Ltd. Cavalier Sheet Metal Works Cotterill Engineers Ltd Custom Frames Ltd Specialists in Picture Framing HQ Woodcraft Ltd Bulwell Self Storage & Van Hire Malmic Lace Limited The Hydroponics Centre CNTL Limited Specialist Precision Engineering TS Auto Sutton Auto factors Tank Farm Limited Sherwood of Nottingham Nixon Hire Skills Coaches (Depot)</p> <p>The site has three vacancies;</p> <ul style="list-style-type: none"> • 17,470 sq. ft. of warehouse and office space to let (Knight Frank) • A former repairs and servicing premises (Vag tech Nottingham Ltd.) for sale (0.12ha) • Industrial/warehouse unit to let (7,887 sq. ft.) 	
<p>Strategic Road Access</p>	<p>The site adjoins the A6002 via Seller's Wood Drive from the north-west. The A6002 connects the site to the M1 (at Nuthall Interchange), approximately 4.55km to the south-west.</p>	<p>Average</p>
<p>Local Road Access</p>	<p>The north of the site is accessed from Belgrave Road and the southern area of the site from Lillington Road.</p> <p>Lillington Road traverses through residential areas and has limited parking restrictions. Consequently, vehicles park on the road and narrow the width of the carriageway.</p>	<p>Poor</p>
<p>Proximity to Urban Areas and Access to Labour and Services (including public transport / cycling / walking accessibility)</p>	<p>The site is located within Bulwell and is accessible to the wider area via good pedestrian infrastructure. Bulwell itself has eatery and retail facilities such as Tesco Extra, Lidl and Weatherspoon's approximately 0.5km to the east. A public footpath is also located in the centre of the site with routes towards Northern Cemetery, Meadow Rise and Low Wood Road.</p> <p>The site itself has no cycling infrastructure; however, a cycle lane is designated within the road carriageway along Seller's Wood Drive with a shared pedestrian cycleway following the A6002</p>	<p>Good / Very Good</p>

	<p>in both directions.</p> <p>The site is not directly serviced by bus, with the closest stop 0.63km to the south-east. However, the site is approximately a 5-minute walk from Bulwell train station and tram stop. The station connects Bulwell to Worksop and Nottingham with the trams servicing Hucknall and Toton Lane.</p>	
<p>Compatibility of Adjoining Uses (including amenity impacts experienced by current/future occupiers and neighbouring areas)</p>	<p>The site is bound by Seller's Wood Drive along its western boundary. To the north-east, Greasley Street begins to merge with the surrounding residential area.</p>	Very Poor
<p>Developmental and Environmental Constraints (e.g. size; topography; site access; roads, lighting, landscaping, mains utilities and communications infrastructure; flood risk; contamination; nature and heritage conservation)</p>	<p>The site is somewhat oval in shape with a generally flat topography around Greasley Street, First, Second and Third Avenue. The site has a marginally sloping access along Belgrave Road.</p> <p>The site has numerous access points.</p> <p>The north of the site is accessed from Belgrave Road and the southern area of the site from Lillington Road.</p> <p>A review of Flood Maps for Planning (Gov.uk, 2021) shows the site immediately borders a Flood Zone 2/3 designation to the east.</p> <p>The site does not contain any listed buildings, nor are there any evident in the immediate vicinity (Historic England Listing Map, 2021).</p>	Average / Good
<p>Barriers to Delivery and Mitigation (including ownership constraints - if known)</p>	<p>The site is located within an Air Quality Management Area (Local Plan Policy IN2) and partly within a Mineral Safeguarding Area (Local Plan Policy MI1).</p>	Average
<p>Market Attractiveness (including appropriateness, vacancy and market activity on site for the type of development proposed)</p>	<p>The site has three vacancies:</p> <ul style="list-style-type: none"> • 17,470 sq. ft. of warehouse and office industrial unit to let (Knight Frank) • 7,887 sq. ft. of industrial/warehouse unit to let at £36,000 p.a. (NG Chartered Surveyors) • A former repairs and servicing premises (Vag tech Nottingham Ltd.) is for sale (0.12ha). A contact number is advertised to contact the seller, there is no formal marketing agent evident. <p>NG Chartered surveyors described Greasley street</p>	Good

	<p>as an established area dating from the 50/60s.</p> <p>Many of the units are in a somewhat run-down condition and are in need of refurbishment. The site is also surrounded on all sides by residential uses reducing its market attractiveness for B2/B*.</p>	
Strategic Fit with Growth Area Objectives (by target Market Segment)	<p>The following industrial growth sectors are already located within the site;</p> <ul style="list-style-type: none"> • Construction • Retail <p>The site is located within the Nottingham 'Regional Centre' (as identified in the D2N2 Vision 2030 document).</p>	Average
OVERALL SITE RATING	Average / Poor	
Recommendation and Potential Future Uses	<p>Protect for employment uses</p> <p>Retain current Local Plan designation as a major business Park/industrial estate</p> <p>The site is a long-established industrial estate with relatively high levels of occupation. Greasley Street would benefit from renovation given that some of the buildings appear dated and are in a poor/tired condition. Despite the poor appearance of many of the buildings, occupancy levels remain high and it is clearly fulfilling a local need.</p>	
SITE SUMMARY:		
<p>The site is located within Bulwell, approximately 11.3km north-west of Nottingham city centre. The site consists of a number of industrial units and buildings in a relatively poor and tired condition dated from the late 1980s and early 1990s. The occupants of the site are classified within class E, B2 and Sui Generis uses. Given the site's long-established use as an industrial site and relatively high levels of occupancy the site should retain its Local Plan designation as a Major Business Park/Industrial Estate, and it is recommended for the site to be protected for employment uses. The buildings within the site would ultimately benefit from some renovation given their age and condition. This may assist in attracting tenants to the vacant buildings, although in general occupancy levels are good.</p>		

Nottingham Science & Technology Park (Ref: NCC5)



**GROSS SITE AREA:
10.21 ha**

**ESTIMATED NET DEVELOPABLE AREA:
0 ha**

CRITERIA	COMMENT	RATING
<p>Site Context</p> <ul style="list-style-type: none"> • Location with regards to existing employment areas and other sites • How the site fits into the overall portfolio 	<p>The site is located approximately 5.0 km to the south-west of Nottingham City Centre. Strategically positioned, Nottingham Science Park benefits from its excellent location immediately opposite the University of Nottingham to the north of the site, Boots HQ to the south-west and Queen's Medical Centre to the north-east.</p> <p>The site neighbours multiple employment areas including the Riverside/Lenton Lane areas to the south, with Padge Road and Lilac Grove to the west. In total, there are three designated Enterprise Zones across Nottingham, of which Nottingham Science and Technology Park is within one of the three designated zones.</p> <p>Nottingham City Council and D2N2 LEP are working in partnership to further develop the site, in accordance with the ambitions of the Nottingham Growth Plan to support business expansion and create new jobs. Additional Grade A office space is scheduled to be completed by January 2021 with construction of the Elizabeth Garrett Anderson Building.</p>	
<p>Local Plan Designation</p>	<p>The site is allocated within the Nottingham City Local Plan as a Major Business Park/Industrial Estate (Local Plan Policy EE2) and is located within an Air Quality Management Area (Local Plan Policy IN2), Mineral Safeguarding Area (Local Plan Policy MI1) and Petroleum Exploration and Development Licence Area (Local Plan Policy MI3). Part of the south-eastern area of the site is allocated as a development site for 9000sqm of office floorspace (Site Reference SR43, University Boulevard, Nottingham Science and Technology Park).</p>	

	<p>To the south-west, the site borders a Local Wildlife Site and a Local Nature Reserve (Local Plan Policy EN6, Beeston Sidings). The site also borders and are of Open Space to the north (Local Plan Policy EN1) with proposed cycle route improvements (Local Plan Policy TR3 beyond).</p>
Status in SHLAA	N/A
Planning History	<p>Recent planning history includes;</p> <ul style="list-style-type: none"> 17/02866/PFUL3 – Full planning application – Three storey office building (B1) with undercroft parking, café, conference and meeting space at ground floor – Granted 25.01.19
Current Use and Land Type	<p>Twelve buildings occupy the site: Faraday building, Heathcoat building, William Lee building, Sir Isaac Newton Centre, Rutherford House, Edison Village, Albert Einstein building, Alexander building and Bell House.</p> <p>The buildings form modern educational, office and research labs space with some office courts available. The buildings are constructed of contemporary metallic materials and brick, ranging in height from 1-3 storeys some with ancillary and underground parking. The site has a single traditional industrial unit to the rear of the site, but predominately contains modern hybrid work spaces such as the Faraday building – a stylish compartmentalised building with a metallic yellow exoskeleton – and the Heathcoat building – a second compartmentalised building with grey and red metallic external frame.</p> <p>The business premises occupying the site comprise of class E and B2 uses.</p>
Occupier Profile (if partly developed, including % of available land and levels of vacancy onsite)	<p>Occupiers of the site include:</p> <p>University of Nottingham (International College), OEGEN (Business Development service), 121 Systems (software company), Chinook Sciences (research group specialising in nuclear, metal and industrial gas industries), Markem Imaje (global supplier of coding and marking equipment), Xaar (manufacturer of inkjet technologies), Verus Metrology Partners, Upperton Pharma Solutions, Wolseley, Leathams Telesales, Formpipe Life Science, Agrovista (Agricultural Service), BYG Systems (software company)</p> <p>Faraday Units – Future Health, Future Health Technologies, Promethean Particles Ltd, IMPT Limited, ISC Networks Limited, Videojet Technologies Ltd., Mad Science, BIW Technologies Ltd, and Tracksys Limited.</p> <p>Marketing signs indicate the following vacancies across the site;</p>

	<ul style="list-style-type: none"> • Unit 8 William Lee Building, office to let (3,163 sq. ft.) (Innes England) • Units 6, 8,11, 16, 18, 19, 20 and 24 for research, development and small-scale production within 276-680 sq. ft. (Property Plus). 	
Strategic Road Access	The site immediately adjoins the A6005 (University Boulevard) and is approximately 0.41km west of the A52 (Clifton Boulevard).	Average
Local Road Access	The site immediately adjoins the A6005 with a traffic light junction and designated right hand turn on approach onto Jesse Boot Avenue - a short, single one-way carriageway into the site.	Very Good
Proximity to Urban Areas and Access to Labour and Services (including public transport / cycling / walking accessibility)	<p>The site is located within the electoral ward of Dunkirk and Lenton, some of the buildings on site benefit from purpose-built cafes (such as the newly constructed Elizabeth Garrett Anderson building) but eatery facilities are also available at the University of Nottingham opposite.</p> <p>The site has a high quality landscaped public realm parkland with a lilipad boardwalk and an excellent shared pedestrian cycleway infrastructure throughout. A newly constructed cycle and footbridge also links the site to the Boots Campus at the rear of the site.</p> <p>Buses service the immediate entrance of the site, with routes towards Nottingham city centre, QMC, the University, Rylands, Beeston, Bramcote and Stapleford. Adjacent the site is the University of Nottingham Tram Stop with services to Hucknall and Toton Lane and Nottingham train station in the city centre.</p>	Very Good
Compatibility of Adjoining Uses (including amenity impacts experienced by current/future occupiers and neighbouring areas)	<p>The neighbouring premises including the University and Riverside/Lenton Lane complement the Park. Despite the adjoining Local Wildlife Site /Nature reserve, the site connects and capitalises with this space via pedestrian walkways.</p> <p>Some residential gardens however border the site to the east.</p>	Good
Developmental and Environmental Constraints (e.g. size; topography; site access; roads, lighting, landscaping, mains utilities and communications infrastructure; flood risk; contamination; nature and	<p>The site is rectangular in shape with level topography. Ingress to the site follows a one-way system along Jesse Boot Avenue with egress to the west.</p> <p>A review of Flood Maps for Planning (Gov.uk, 2021) shows the entire site is located within a</p>	Average

heritage conservation)	<p>Flood Zone 2 (to the south-west) of the site and a Flood Zone 3 (to the north-east) of the Park. However, the area of land falling within a Flood Zone 3 does benefit from flood defences.</p> <p>The site does not contain any listed buildings; however, to the north, across Castle Boulevard, Highfields Park is a Grade II* Listed park (Historic England Listing Map, 2021).</p>	
<p>Barriers to Delivery and Mitigation (including ownership constraints - if known)</p>	<p>The site benefits from Enterprise Zone status.</p> <p>The site is also located within an Air Quality Management Area (Local Plan Policy IN2), Mineral Safeguarding Area (Local Plan Policy MI1)</p>	Very Good
<p>Market Attractiveness (including appropriateness, vacancy and market activity on site for the type of development proposed)</p>	<p>The site has several vacancies;</p> <ul style="list-style-type: none"> Unit 8 William Lee Building, self-contained single storey brick built semi-detached office to let (3,163 sq. ft.) with 13 car parking spaces (Innes England) Units 6, 8,11, 16, 18, 19, 20 and 24 for research, development and small-scale production within 276-680 sq. ft. of 'quality scientific office/workshop units' (£3,590 - £8,840 p.a.) (Property Plus). <p>The Elizabeth Garrett Anderson Building is scheduled to open January 2021 and contains Grade A offices and research labs to let (between 2,271- 22,723 sq. ft.) (Carter Jonas).</p> <p>The agent states that the building will act as a central hub building for new and existing occupiers across the park. The building will have a café and conference facilities for tenants across the park to use, providing a space to engage, share knowledge and ideas.</p>	Very Good
<p>Strategic Fit with Growth Area Objectives (by target Market Segment)</p>	<p>The following industrial growth sectors are already located within the site;</p> <ul style="list-style-type: none"> Life Sciences Creative & Digital Health/Social Care Professional/Business Service <p>The site is located within the Nottingham 'Regional Centre' (as identified in the D2N2 Vision 2030 document).</p>	Very Good
OVERALL SITE RATING	Very Good	
Recommendation and	Protect for employment uses	

Potential Future Uses	<p>Retain current Local Plan designation as a major business/industrial estate</p> <p>Given the site's Enterprise Zone designation and associated vision for the site as defined by Nottingham City Council and D2N2 the site should retain its Local Plan designation as a Major Business/Industrial Estate particularly with the forthcoming opening of the office and research/lab space at the Elizabeth Garrett Anderson Building.</p>
------------------------------	---

SITE SUMMARY:

The site is located approximately 5.0km to the south-west of Nottingham city centre and is strategically positioned in respect of neighbouring industries which include the University of Nottingham, Boots HQ and Queen's Medical Centre. The site is of modern construction, comprising of educational, office and research lab facilities. The site benefits from Enterprise Zone Status and consequently has limited vacancies. A new building – the Elizabeth Garrett Anderson Building – is scheduled to be completed on the site by January 2021 providing Grade A Office and research lab space with café and conference facilities on the ground floor, available to all across the park.

Given the site's Enterprise Zone Status, its high levels of occupation and strategic location the site should clearly retain its Local Plan designation as a Major Business/Industrial Estate, and it is recommended to protect the site for employment uses.

Stanton Tip - Hempshill Vale (Ref: NCC6)

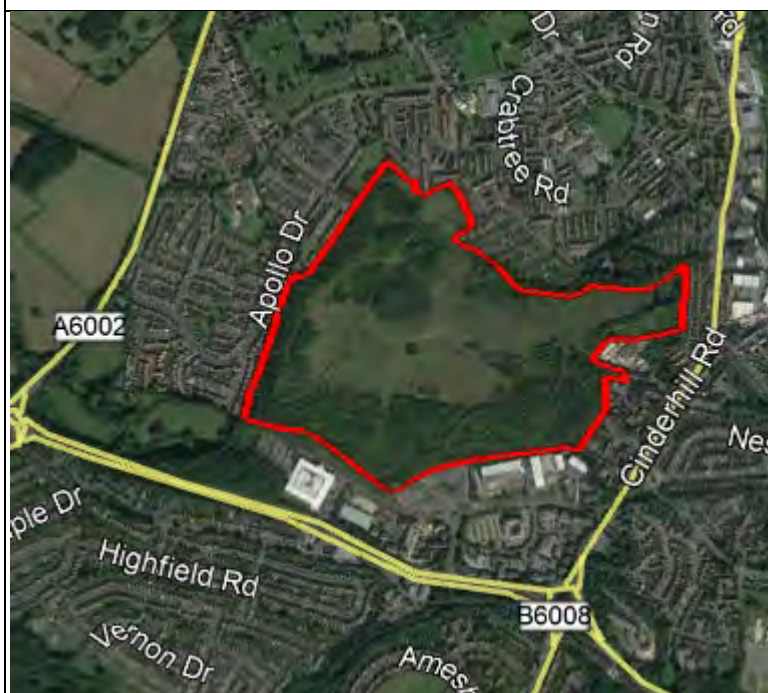

**GROSS SITE AREA:
42.61 ha**

**ESTIMATED NET DEVELOPABLE
AREA:
31.95 ha
(75% adjustment)**

CRITERIA

COMMENT

RATING

Site Context

- Location with regards to existing employment areas and other sites
- How the site fits into the overall portfolio

The site is located within the suburbs of Nottingham at the south-western edge of Bulwell and north-west of Cinderhill.

The site is located approximately 10 km from the city centre and within close proximity to the M1. The site is undeveloped but is in close proximity to other designated employment areas including Phoenix Park to the south, Greasley Street and Blenheim industrial areas to the north with Rolls Royce beyond.

Local Plan Designation

The site is allocated within the adopted Nottingham City Local Plan as a development site (Local Plan Policy RE7, site reference SR11) for a mixed-use development comprising of 350 dwellings, 5-10ha of industrial or warehousing units and small-scale retail.

The site is also located within an Air Quality Management Area (Local Plan Policy IN2) and Mineral Safeguarding Area (Local Plan Policy MI1).

To the south of the site is Phoenix Park, allocated as a Major Business Park / Industrial estate (Local Plan Policy EE2)

Beyond the sites borders are allotments to the north, with a Local Wildlife Site (Local Plan Policy EN6) to the north-east.

Status in SHLAA

Site ID: 254 Stanton Tip – Hempshill. Overall Conclusion: Developable for 500 dwellings delivered over 6+ years.

Planning History	No recent planning history to note.	
Current Use and Land Type	Site is vacant, used for recreational purposes/open space. Land type is brownfield.	
Occupier Profile (if partly developed, including % of available land and levels of vacancy onsite)	The site is undeveloped and is constrained by developed areas on all sides.	
Strategic Road Access	Should the site be developed Stanton Tip could have access to the A610 to the south and have access to the M1 within 1.8 km.	Average
Local Road Access	The site is not easily accessible by local road networks, although there are spurs to the site via residential roads such as Paddock Close and Bonington Close. Parking on Millennium Way east allows walking ingress to the site.	Poor
Proximity to Urban Areas and Access to Labour and Services (including public transport / cycling / walking accessibility)	<p>Located within the suburb of Bulwell and Cinderhill, the site is in close proximity to both areas that contain retail and food premises accessible from the wider walking routes from the site. The site has no formal pedestrian or cycle infrastructure, numerous footpaths are evident from routes to the residential areas in the north.</p> <p>Should the site be developed, the site would benefit from the transport connectivity at Phoenix Park to the south and access to the A610 and M1. The development principles for Stanton Tip (as detailed under SR11) specify that improved pedestrian and cycle links are required through the site and to the tram stop.</p>	Very Good
Compatibility of Adjoining Uses (including amenity impacts experienced by current/future occupiers and neighbouring areas)	<p>The site is surrounded by residential neighbourhoods (with some areas of allotments) to the north, a small industrial site to the east (including Hucknall Sheet Metal and Print Nottingham) and Phoenix Park to the south.</p> <p>The site is also located within an Air Quality Management Area (Local Plan Policy IN2).</p>	Poor
Developmental and Environmental Constraints (e.g. size; topography; site access; roads, lighting, landscaping, mains utilities and communications infrastructure; flood risk; contamination; nature and	<p>As an undeveloped site there is no evidence of utility infrastructure such as communications and lighting.</p> <p>Given its undeveloped state the site is well vegetated throughout with wildlife in residence.</p>	Very Poor

heritage conservation)	<p>The site is a former tip; there is potential for contamination and causing of groundwater pollution during development (SR11).</p> <p>The site is constrained by its sloping and inclined topography towards the centre of the site where the area plateaus on the summit.</p> <p>The site does not contain any listed buildings; however, to the east are Bagnall Cottages (1, 2 and 3) which are Grade II listed (Historic England Listing Map, 2021).</p> <p>Although Stanton Tip is not located within a flood zone (Flood Maps for Planning, Gov.uk, 2021), a site-specific flood risk assessment would be required as part of the development and must consider the site topography and potential for overland flooding due to the site's steeply sided slopes (SR11).</p>	
Barriers to Delivery and Mitigation (including ownership constraints - if known)	<p>SHLAA 2020 details the site is not owned by a public authority. A willing owner is apparently positively engaged with Nottingham City Council.</p> <p>The site is also located within an Air Quality Management Area (Local Plan Policy IN2) and Mineral Safeguarding Area (Local Plan Policy MI1).</p>	Average
Market Attractiveness (including appropriateness, vacancy and market activity on site for the type of development proposed)	<p>Should Stanton Tip be developed, the site has good potential for fulfilling market needs. For example, the site immediately adjoins Phoenix Park which has exemplary transport connectivity, with a strong offer for office accommodation. Any forthcoming development has potential to complement the existing businesses within the Park. Similarly, the site should capitalise on the adjoining road network with access to the M1 within 1.8km.</p>	Good
Strategic Fit with Growth Area Objectives (by target Market Segment)	<p>Given the adjoining businesses in Phoenix Park, the site has potential to accommodate several of the industrial D2N2 targeted growth sectors including Creative & Digital, Visitor Economy, Retail, Health/Social Care, Professional/Business Service and in some capacity, Logistics and E-commerce.</p> <p>The site is located within the Nottingham 'Regional Centre' (as identified within the D2N2 Vision 2030 document).</p>	Very Good
OVERALL SITE RATING	Average	

<p>Recommendation and Potential Future Uses</p>	<p>Designate for mixed-use with element of employment use (i.e. retain current Local Plan designation as a development site (site reference SR11, Policy RE7))</p> <p>Given the site's proximity to existing residential areas and the opportunity to capitalise on adjoining transport connections at Phoenix Park and the M1, the site presents an opportunity for the sustainable delivery of both employment space and residential dwellings.</p>
--	--

SITE SUMMARY:

The site is located within the suburbs of Nottingham at the south-western edge of Bulwell and north-west of Cinderhill. The site is approximately 10 km from the city centre and within reasonably close proximity to the M1.

The site is undeveloped but is allocated within the Nottingham City Local Plan as a mixed-use development site (Local Plan Policy RE7, site reference SR11) for development comprising of 350 dwellings, 5-10ha of industrial or warehousing units and small-scale retail.

As a former tip the site has potential for encountering contamination during development and generating groundwater pollution during development. In addition, given the site's steep sided topography there is potential for overland flooding, and this must be considered within a site-specific flood risk assessment prior to the development of the site. Overall, the site is an opportunity for the sustainable delivery of both employment space and residential dwellings as a result its proximity to residential areas and established transport networks. It is recommended to designate the site for mixed-use with an element of employment use (with a portion for industrial or warehousing uses) (i.e. retain current Local Plan designation as a development site).

Canal Quarter - Island Site (Ref: NCC7)



**GROSS SITE AREA:
9.76 ha**

**ESTIMATED NET DEVELOPABLE AREA:
7.02 ha**
(based on developed area as indicated on the illustrative masterplan for application 18/01354/POUT)

CRITERIA

Site Context

- Location with regards to existing employment areas and other sites
- How the site fits into the overall portfolio

COMMENT

Formerly known as the 'Boots Island site', the site is located to the south-east of Nottingham city centre, adjacent to The Great Northern Close and comprises a generally flat, irregularly-shaped parcel of land. The site is generally derelict, comprising of overgrown vegetation, the former Great Northern Warehouse and James Alexander Building and a substantive car park.

Outline planning was approved in July 2020 for the development of new homes, Grade A office space, a hotel, retail units and student accommodation with full planning approved for phase 1 of the development in November 2020. The site is located within the Canal and Creative Quarters, with the development of the site fulfilling the strategic ambitions of Local Plan Policy RE2 and RE3. The site has been derelict since 1994, but the approved plans will result in significant regeneration of the land estimated to cost £650m (NottinghamshireLive, 2020).

The site is strategically located behind Biocity and adjacent the BBC Nottingham Buildings, NHS Urgent Treatment Centre and Nottingham Train Station. The vision of the site is to develop a new urban business and residential community with its own identity and character, resulting in a site that will contribute significantly to the economic growth of the City by facilitating economic change and providing the expansion of the adjacent life science cluster (Island Site SPD, adopted April 2016).

RATING

<p>Local Plan Designation</p>	<p>The site is located within the Nottingham City Local Plan as part of the Canal and Creative Quarter (Local Plan Policy RE2 and RE3). The site is also designated as a development site (Local Plan Policy SA1, site reference SR59) for the provision of 500 dwellings, 43,900 sqm. of office floorspace (min approx.) and 3,000 sqm. of retail floorspace (min. approx.)</p> <p>Accordingly, the adopted Island Site SPD (adopted April 2016) details the site is the largest undeveloped site in the city centre and notes the key outcomes for the site are;</p> <ul style="list-style-type: none"> ·Develop 66,000 sqm of new office floorspace; ·Deliver 500-650 new homes ·Further expansion space for biosciences ·Retail, leisure and community uses to complement the residential and employment offer; ·New uses for the Great Northern Warehouse and James Alexander Warehouse ·New streets and routes; ·High quality new open space and public realm. <p>To the east, is a designated proposed cycle route improvement (Local Pan Policy TR3) and highway route improvement safeguarding (Local Plan Policy TR2) with a Local Wildlife Site (Local Plan Policy EN6, site reference 2/57) and Rivers, Canals and Waterway designation to the west (Local Plan Policy EN5). Cycle Route Improvements are also proposed to the west along Lenton Canal (Local Plan Policy TR3).</p> <p>Other designations of the site include;</p> <ul style="list-style-type: none"> • Archaeological Constraints Area (Local Plan Policy HE1); • Mineral Safeguarding Area (MI1); • Petroleum Exploration and Development Licence Area (MI3); and • Air Quality Management Area (IN2)
<p>Status in SHLAA</p>	<p>Site ID: 346 – Canal Quarter – Island Site, Manvers Street – Overall Conclusion: Deliverable for 1273 dwellings. The site is also allocated under Local Plan Policy SA1</p>
<p>Planning History</p>	<p>Recent planning history includes;</p> <ul style="list-style-type: none"> • 17/01986/NFUL3 – Full planning application - Use of site as a temporary public car park whilst works on the Broadmarsh multi-storey car park are being carried out – Granted 25.10.17 • 18/01354/POUT – Outline planning application -

	<p>Outline application for mixed use comprising; 17,274sq.m of Creative Market uses; 58,885sq.m of offices (Class B1); 14,413sq.m of non-residential institution (Class D1); 91,888sq.m of residential (Class C3); 4,153sq.m of local retail (Class A1, A3, A4 & A5); 8,118sq.m of hotel (Class C1); 27,030sq.m of student accommodation (Class C3 and sui generis); 1,796 car parking spaces (including 47,258m2 multi-storey), with facilitating works including demolitions; on and off-site highway works; public realm and pedestrian/cycle facilities; and drainage and utility infrastructure, including gas compound and substations (See form for full description) – Granted 01.06.20</p> <ul style="list-style-type: none"> • 20/01527/PFUL3 – Full planning application - Mixed-use commercial development comprising enabling works (demolition and earthworks), retail (Classes A3/A4/A5), assembly and leisure (Class D2) uses, access modifications, utility infrastructure and drainage, new areas of public realm/landscaping and alterations to the listed Turnover Bridge (Phase 1A of the Island Quarter development) – Granted 27.11.20 	
Current Use and Land Type	<p>The site is generally derelict comprising of an overgrown concreted vegetated area with the Great Northern Warehouse and James Alexander Building to the south. A substantive car park (sui generis) occupies a predominant area of land within the site a single business - Gem radio – currently occupies the site (class E).</p>	
Occupier Profile (if partly developed, including % of available land and levels of vacancy onsite)	<p>The majority of land is undeveloped, albeit the single radio station within the east of the site. The premises is a modern metallic unit with ancillary parking.</p>	
Strategic Road Access	<p>The site immediately adjoins the A60 and A612.</p>	<p>Average</p>
Local Road Access	<p>The site immediately adjoins the A60 and A612, with access to the A60 via a traffic light junction. City Link provides a direct route through the centre of the site.</p>	<p>Very Good</p>
Proximity to Urban Areas and Access to Labour and Services (including public transport / cycling / walking accessibility)	<p>The site is located within Nottingham City Centre and is within walking distance of multiple national retailers and hospitality venues. The site has good pedestrian infrastructure along the central axis of the site, parallel with City Link, providing a shared pedestrian cycleway towards Biocity, the station, City Centre, Sneinton, Colwick and West Bridgford.</p> <p>A single bus stop is located within the site with services to Victoria Retail Park. The rail station is also located within c.1.1km of the site, with trains to London St Pancras International, Skegness, Liverpool Lime Street, Newark Castle, Cardiff</p>	

	Central, Leeds, Worksop, Lincoln Central, Norwich and East Midlands Station.	
Compatibility of Adjoining Uses (including amenity impacts experienced by current/future occupiers and neighbouring areas)	As a city centre site, the area neighbours various occupants including Biocity, NHS Urgent Treatment Centre, BBC Nottingham and Nottingham Train Station. The railway line binds the site along its southern border with the A612 constraining the site to the east.	Very Good
Developmental and Environmental Constraints (e.g. size; topography; site access; roads, lighting, landscaping, mains utilities and communications infrastructure; flood risk; contamination; nature and heritage conservation)	<p>The site is relatively flat throughout with gravelled/concreted foundations in use as a car park and former Great Northern Warehouse and James Alexander Building.</p> <p>Ingress to the west of the site, along City link is controlled via a security barrier with gatehouse.</p> <p>A review of Flood Maps for Planning (Gov.uk, 2021) shows the majority of the site is located within a Flood Zone 2.</p> <p>The Great Northern Warehouse within the site is designated as a Grade II listed building (Historic England Listing Map, 2021).</p>	Average
Barriers to Delivery and Mitigation (including ownership constraints - if known)	<p>According to the SHLAA (2020) the site is subject to contamination.</p> <p>The site is subject to proactive regeneration activity by Nottingham City Council (Local Plan Policy RE2 and RE3) with an adopted SPD to further guide spatial development.</p> <p>Given the proactive actions of the Council, the delivery of the site is expected mid/late within the plan period (SHLAA, 2020).</p> <p>The site is owned by Conygar Investment Company PLC (Conygar, 2021).</p>	Average
Market Attractiveness (including appropriateness, vacancy and market activity on site for the type of development proposed)	Hotel Indigo have already signed terms with Conygar to be the occupier of the hotel within the Island Site (Conygar Latest News Bulletin, 2021).	Very Good
Strategic Fit with Growth Area Objectives (by target Market Segment)	The site is located within the Nottingham 'Regional Centre' (as identified in the D2N2 Vision 2030 document).	Very Good
OVERALL SITE RATING	Good The site is a key regeneration opportunity for the city centre and offers a sustainable opportunity for the reuse of	

	<p>brownfield land for mixed use development, including an element of office.</p> <p>The site also neighbour's complimentary city centre employment premises and is within close proximity to the train station.</p>
<p>Recommendation and Potential Future Uses</p>	<p>Designate for mixed-use with element of employment use (i.e. retain current Local Plan designation as a development site (site reference SR59, Local Plan Policy SA1))</p> <p>Given the site's approved planning history and the forthcoming development the site should retain its designation as a mixed-use development site including an element of office (Local Plan Policy SA1, site reference SR59).</p>
<p>SITE SUMMARY:</p>	
<p>Formerly known as the 'Boots Island site', the site is located to the south-east of Nottingham city centre. The site is generally vacant and derelict, comprising of overgrown vegetation, the former Great Northern Warehouse and James Alexander Building and a substantive car park. The site is subject to proactive regeneration and supporting policy including being allocated as a development site (Local Plan Policy SA1, site reference SR59) and the adoption of the Island Site SPD (adopted April 2016).</p> <p>An outline planning application was approved in July 2020 for the development of new homes, Grade A office space, a hotel, retail units and student accommodation with full planning approved for phase 1 of the development in November 2020.</p> <p>Given the extensive regeneration efforts and forthcoming approved development the site should retain its Local Plan designation and it is recommended to designate the site for mixed-use with element of employment use (i.e. retain current Local Plan designation as a development site) containing an element of office floorspace.</p>	

Waterside - Freeth Street (Ref: NCC8)



**GROSS SITE AREA:
8.45 ha**

**ESTIMATED NET DEVELOPABLE AREA:
0 ha**

CRITERIA	COMMENT	RATING
<p>Site Context</p> <ul style="list-style-type: none"> • Location with regards to existing employment areas and other sites • How the site fits into the overall portfolio 	<p>The site is located south-west of the city centre and on the north bank of the River Trent. The site forms part of the Waterside Regeneration Zone. The vision of the adopted Waterside SPD aims to capitalise on the areas 'prime central location' and 'close relationship' with Nottingham and the River Trent through the development of a sustainable residential waterside community of high-quality urban design comprising of a primary school, small-scale local retail, leisure and employment uses in a bid to attract families back to the city.</p> <p>The development will also benefit from a continuous footpath and cycleway along the north bank of the River Trent, pedestrian and cycle access across the river, to the city centre and surrounding communities (Waterside Nottingham SPD, 2019).</p> <p>Neighbouring the site to the north is the modern Ladybay Retail Park, with the site also in close proximity (c.0.6km) of Notts County and Nottingham Forest Football Clubs.</p>	
<p>Local Plan Designation</p>	<p>The site is allocated within the Nottingham City Local Plan for mixed used development comprising of 100/200 dwellings (min/max dwellings) and approximately 3000 sqm. of office floorspace (max approx.) (Local Plan Policy SA1, site reference SR72).</p> <p>The site is also designated within the Waterside Regeneration Zone (Local Plan Policy RE1 & RE8) under 'PA82 Waterside' of the Waterside Nottingham SPD (adopted 2019) for Residential (C3), office (B1) and small-scale convenience</p>	

	<p>retail (A1) and restaurant/café (A3) and non-residential institution (D1)</p> <p>The SPD details that the regeneration of Freeth Street will likely result in a major positive outcome for the Housing and Landscape/Townscape objectives.</p> <p>Other site designations include;</p> <ul style="list-style-type: none"> • Air Quality Management Area (Local Plan Policy IN2) • Mineral Safeguarding Area (MI1) • Petroleum Exploration and Development Licence (MI3) <p>The site borders a two additional development sites to the east and west for further mixed-use development (site references SR73 and SR71). The site borders the River Trent to the south (Local Plan Policy EN5), proposed cycle route improvements are designated along the river and to the north along the A612.</p>
Status in SHLAA	Site ID: 516 – Overall Conclusion: Developable for 385 dwellings.
Planning History	No recent planning history to note.
Current Use and Land Type	<p>The site is occupied by a mix of small industrial units/workshops spread across multiple courts. The site also contains a recycling plant with lorry weighbridge on entry and scrap yard to the south. The buildings of the site are in a poor/average condition with multiple vacant and derelict properties including an early 1980s office block (0.33ha) and derelict skeleton of a former industrial unit.</p> <p>The site does contain some modern premises such as a Screwfix, Topps Tiles and Karcher store along its northern frontage, however generally the buildings across the site date from the early 1990s. A former primary shopping frontage is located along the A6011, however most premises appear to be closed. Approximately 4 dwellings are located within the centre of the site with ancillary parking, as with the other buildings on the site they too appear to be in a very tired condition.</p> <p>In summary, the occupants of the site include classes C3, B2, E and Sui Generis premises.</p>
Occupier Profile (if partly developed, including % of available land and levels of vacancy onsite)	<p>Occupiers of the site include:</p> <p>Moreland Court – Sabre Autos, Composite Design Studio, Automodz Brand Street, Pumptec Pump & Valve Repairs Ltd, DTM Car Body & Alloy Wheel Repairs, TAC (Practical Area)</p> <p>Dayland Glass, Glass & Recycling, ExpressGlaze, Rinus Roofing Supplies, Keline Civils Specialist, Topps Tiles, Karcher, Meadow Lane Scrap, Blu Max Metal Finishers, Dale Textiles Ltd., Eyesore Merch, Sherwood Jet Vac, Artificial Grass megastore, Texaco Petrol Station, Screwfix, Beauty</p>

	<p>Salon Supplies Ltd., J.W Alvey & Son, AMB Audi, PM Porsche Independent Porsche Specialist and Smurfit Kappa Recycling</p> <p>Meadow Court – Xclusive Design, Stirling Plastics</p> <p>Trentview Court – Robvic Ltd Trading as Lloyds Joinery, Direct Hire & Sales, Pirtek Nottingham Ltd, County Engraves & Signs Ltd.</p> <p>A number of units are unoccupied/vacant including:</p> <ul style="list-style-type: none"> • Meadow Court – 6 unoccupied • Moreland Court – 1 unoccupied • Trentview – 1 unoccupied • Ami Furniture • Derelict industrial unit skeleton • Derelict office building (c.1980s) • Lady Bay House office accommodation 	
Strategic Road Access	<p>The site directly adjoins the A612 and A6011 (Meadow Lane). Access from the A612 onto Moreland Street is poor as a result of queued lorries parked up waiting to deliver to the recycling plant.</p>	Average
Local Road Access	<p>The site directly adjoins the A612 and A6011 (Meadow Lane). A lack of parking and parking restrictions, particularly on Moreland Street forces vehicles to park on the pavements, thus reducing width of the carriageway.</p>	Average
Proximity to Urban Areas and Access to Labour and Services (including public transport / cycling / walking accessibility)	<p>The site is located to the south-west of the city centre and on the north bank of the River Trent. The site is allocated for the development of a sustainable residential community including restaurants/cafe and small-scale convenience retail.</p> <p>Currently the site is not directly serviced by public transport, a single bus stop is located adjacent Lady Bay Retail Park with regular services towards Nottingham.</p> <p>Policy 7 of the Nottingham Aligned Core Strategy (2014) details that the development will need to facilitate enhanced east-west transport links (including public transport) and the completion of a link road from Trent Lane to Racecourse Road.</p> <p>Although the site is pedestrianised, the majority of pavements are unwalkable due to the number of vehicles parked on the sidewalks. On completion of the development, the SPD details that connectivity to the city centre and across the river will be improved by the construction of a</p>	Very Good (if objectives of the Waterside SPD are achieved)

	continuous pedestrian walkway and cycleway along the river.	
Compatibility of Adjoining Uses (including amenity impacts experienced by current/future occupiers and neighbouring areas)	The site is bound by the A612 and A6012 along its entire northern border. The River Trent also borders the site to the south. It is surrounded by employment / retail / leisure uses.	Very Good
Developmental and Environmental Constraints (e.g. size; topography; site access; roads, lighting, landscaping, mains utilities and communications infrastructure; flood risk; contamination; nature and heritage conservation)	Given some of the existing uses at the site (such as Smurfit Kappa Recycling, scrapyards and petrol station) the site may be subject to contamination and could require some remediation prior to redevelopment. A review of Flood Maps for Planning (Gov.uk, 2021) shows the entire site is located within a Flood Zone 2. The site does not contain any listed buildings (Historic England Listing Map, 2021).	Average
Barriers to Delivery and Mitigation (including ownership constraints - if known)	The site is problematic in terms of site acquisition, remediation and fragmented ownership – despite the Council having significant ownership within the site (SPD Waterside Nottingham, adopted 2019). Should CPO be required then some of the housing will likely be provided beyond the Local Plan Part 2 Period (SPD Waterside Nottingham, adopted June 2019).	Poor
Market Attractiveness (including appropriateness, vacancy and market activity on site for the type of development proposed)	Despite Meadow Court, Moreland Court and Trentview having a combined 8 unoccupied units, the managing agent has not listed these online. Three other properties on the site (Ami furniture building c.7,000 sq. ft.), a derelict skeleton of former industrial unit (c.2,868 sq. ft.) and derelict office building c.1980s (c.6,900 sq. ft.) are not currently being marketed by an agent. Lady Bay House self-contained Office accommodation are advertised by Innes England to let (1,312 sq. ft. to 2,734 sq. ft.) at an introductory price of £9 per sq. ft. The brochure provides little detail in respect of the site but notes the location has good road access and ‘excellent’ public transport in respect of the bus routes serving Lady Bay Retail Park and the tram and train networks within the city centre.	Poor
Strategic Fit with Growth Area Objectives (by target)	The following industrial growth sectors are already located within the site;	Average

Market Segment)	<ul style="list-style-type: none"> • Creative & Digital <p>The site is located within the Nottingham 'Regional Centre' (as identified in the D2N2 Vision 2030 document).</p>	
OVERALL SITE RATING	Poor / Average	
Recommendation and Potential Future Uses	<p>Protect for mixed-use with element of employment use (i.e. retain current Local Plan designation as a development site (site reference SR72, Local Plan Policy SA1))</p> <p>Given the spatial vision for the site, including the details contained within the Waterside Nottingham SPD (adopted 2019), the site should retain its designation as a mixed use development site (site reference SR72, Local Plan Policy SA1) and Waterside Regeneration Zone allocation with an element of office.</p>	
SITE SUMMARY:		
<p>The site is located south-west of the city centre and on the north bank of the River Trent. The site forms part of the Waterside Regeneration Zone. The vision of the adopted Waterside SPD aims to regenerate the site into a mixed-use sustainable urban community in a bid to attract families back to the city and re-imagine the sites relationship with the bordering River.</p> <p>At present, the site is generally in a tired condition with some bad neighbour uses such as recycling facility and scrap yard in occupation. To develop the site, remediation will be necessary to execute the development safely. Furthermore, despite the Council having significant ownership levels within the site the ownership status across the area remains fragmented. There is no planning history to note; however the future plans for the site are supported by planning policy. The site should retain its current Local Plan allocation, and it is recommended to protect the site for mixed-use with element of employment use (i.e. retain current Local Plan designation as a development site and Waterside Regeneration Zone allocation with an element of office use.</p>		

Haydn Road/Hucknall Road (Ref: NCC9)

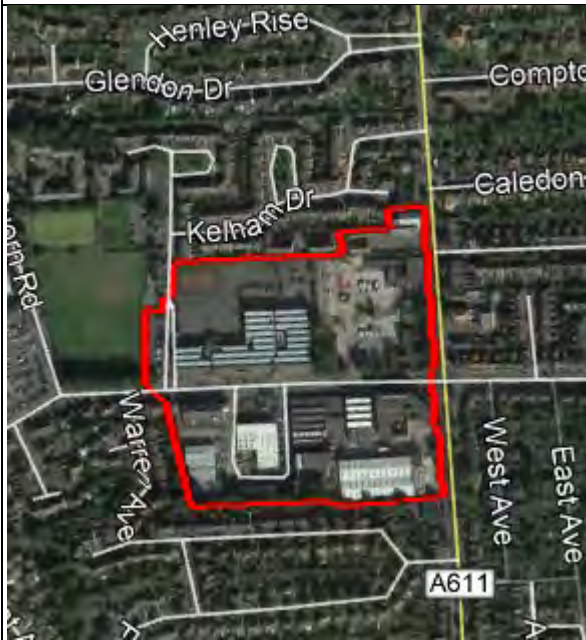

**GROSS SITE AREA:
6.70 ha**

**ESTIMATED NET DEVELOPABLE AREA:
0 ha**

CRITERIA	COMMENT	RATING
<p>Site Context</p> <ul style="list-style-type: none"> • Location with regards to existing employment areas and other sites • How the site fits into the overall portfolio 	<p>The site is located north of Nottingham city centre, within the residential suburb of Sherwood. To the west of the site is New Basford Industrial Estate, Bar Lane/Basford Road and Bar Lane Industrial Estate.</p>	
<p>Local Plan Designation</p>	<p>The site is designated within a Mineral Safeguarding Area (Local Plan Policy MI1) and an Air Quality Management Area (Local Plan Policy IN2) in the Nottingham City Local Plan. Along the southern border of the site is an allocated Local Geological Site (Local Plan Policy EN6).</p> <p>Part of the site is also allocated as a development site (Local Plan Policy SA1, site reference SR17) for mixed-use development including 60-80 dwellings (min/max approx.) and small-scale office development.</p> <p>Proposed cycle route improvements are also designated along Hucknall Road immediately to the east (Local Plan Policy TR3).</p>	
<p>Status in SHLAA</p>	<p>Site ID: 380 for 70 dwellings on part of the site (Severn Trent Water Depot). Overall Conclusion: Developable.</p>	
<p>Planning History</p>	<p>No recent planning history to note.</p>	
<p>Current Use and Land Type</p>	<p>The site is occupied by a diverse range of business including educational and religious premises within class E, F1(a) and F1(f) uses. Generally, the site is divisible into four quarters; The Hartley Business Centre to the south-east, Severn Trent Water to the north-east, Nottingham Free School and retail premises (The Courtaulds Building) to the</p>	

	north-west, Industrial Units to the south-west. The buildings are in a very good condition, particularly the Hartley Business centre that has recently been renovated.	
Occupier Profile (if partly developed, including % of available land and levels of vacancy onsite)	<p>Occupiers of the site include: Nottingham Free School, Dress Place Bridal Boutique Gurdwara Baba Budha Ji (religious institution), CEF, Electrical Distributors, Robin Hood Gymnastics Club, Severn Trent Water Ltd., UK Diamond Drilling Training Centre, ID Learning Development Training with Leeds Trinity University</p> <p>Hartley Business Centre – Nottingham Jewellery School, Rhythm Nation Studios, Garth’s Gym, The Potter’s House (Christian Fellowship Church), Bees bargain beds + furniture, B.E. Webbe Self Storage, Arrow Ceilings Ltd, Absolute Picture Framing, Bespoke Woodwork, Stevenson & Soames Designer Makers, Javeille Brides, Homestead Property Services, Desire Kicks Ltd, Tecnico, Phillip Duffield, Sophie Robins Mosoics, Woodpeckers, Dragon Freestyle Kickboxing, The Trent University, Industrial Glow, Anthony Epworth Ltd, Battle Bunker, Unit 17 Studio, Unique Walls, That’s How International Ltd., Celetial Church of Christ, Moroni 7 Records Ltd, Great Faith Apostolic Church, Sarah Turner Eco Art & Design, The Textile Workbox, Audio Electrical, Spotlight Cleaning Services and Emma Ball Ltd.</p> <p>The site has good levels of occupation with an opportunity to occupy vacant retail space on the ground floor of the Courtaulds building.</p>	
Strategic Road Access	The site adjoins Hucknall Road (A611) which connects to the A6514, approximately 1.5 km to the north.	Average
Local Road Access	Haydn Road passes directly through the site.	Very Good
Proximity to Urban Areas and Access to Labour and Services (including public transport / cycling / walking accessibility)	<p>The site is located to the north of Nottingham city centre, within the residential suburb of Sherwood. The residential surroundings also provide local cafes and food outlets, a large Aldi and Sainsburys supermarket are approximately 1.24 km to the west of the site.</p> <p>A single bus stop services the site on the A611, with services to Sutton in Ashfield, Rise Park, Bulwell, Rise Park and Mansfield. The site has good pedestrian infrastructure which also adjoins the surrounding area. Designated cycle ways in both directions are positioned within the carriageway along Haydn Road.</p>	Very Good

<p>Compatibility of Adjoining Uses (including amenity impacts experienced by current/future occupiers and neighbouring areas)</p>	<p>The site immediately neighbours residential areas to the north, south and south-west. To the west are playing pitches, with the site bound by Hucknall Road along its eastern border.</p>	<p>Very Poor</p>
<p>Developmental and Environmental Constraints (e.g. size; topography; site access; roads, lighting, landscaping, mains utilities and communications infrastructure; flood risk; contamination; nature and heritage conservation)</p>	<p>The site is square in shape, divided by Haydn Road running through the central axis of the site.</p> <p>A review of Flood Maps for Planning (Gov.uk, 2021) and Historic England Listing Map (2021) shows the site is not located within a flood zone nor does it contain any listed buildings.</p>	<p>Very Good</p>
<p>Barriers to Delivery and Mitigation (including ownership constraints - if known)</p>	<p>The site is designated within a Mineral Safeguarding Area (Local Plan Policy MI1) and an Air Quality Management Area (Local Plan Policy IN2) in the Nottingham City Local Plan. Along the southern border of the site is an allocated Local Geological Site (Local Plan Policy EN6).</p>	<p>Average</p>
<p>Market Attractiveness (including appropriateness, vacancy and market activity on site for the type of development proposed)</p>	<p>The site is fully occupied with the exception of 23,776 sq. ft. of retail/leisure/industrial units within the ground floor of the Courtaulds Building.</p> <p>Both FHP and Innes England are the marketing agents for the property, and advertise the following units to let:</p> <ul style="list-style-type: none"> • Unit A – 3,853 sq. ft. • Unit B – 2,906 sq. ft. • Unit C – 16,328 sq. ft. • Unit D – 7,448 sq. ft. <p>FHP detail the price of the units are £6.50 per sq. ft. for a 5-year lease. The site also includes 100 free car parking spaces.</p>	<p>Good</p>
<p>Strategic Fit with Growth Area Objectives (by target Market Segment)</p>	<p>The following industrial growth sectors are already located within the site:</p> <ul style="list-style-type: none"> • Creative & Digital • Retail • Health/Social Care <p>The site is located within the Nottingham 'Regional Centre' (as identified in the D2N2 Vision 2030 document).</p>	<p>Good</p>
<p>OVERALL SITE RATING</p>	<p>Good</p>	
<p>Recommendation and Potential Future Uses</p>	<p>Do Not Allocate the site for employment uses</p> <p>The site is a mixed-use site comprising of a diverse range of premises including religious sites and a school. Despite the number of businesses within the Hartley Business Centre a</p>	

number of these are not commercial/industrial uses such as yoga and art studios. The occupation of Robin Hood Gymnastics Club within the site, adjacent UK Diamond Drilling Training Centre indicates a shift away from traditional industrial uses of the site.

The vacant retail units within the Courtaulds Building presents an opportunity for local retail facilities to complement any forthcoming residential development within the identified SHLAA designation over the Severn Trent Water Depot.

SITE SUMMARY:

The site is located north of Nottingham city centre, within the residential suburb of Sherwood. The site is occupied by a diverse range of business including educational and religious premises within **class E, F1(a) and F1(f) uses**. Generally, the site is divisible into four quarters; The Hartley Business Centre to the south-east, Severn Trent Water to the north-east, Nottingham Free School and retail premises (The Courtaulds Building) to the north-west, Industrial Units to the south-west. The buildings are in a good condition, particularly the Hartley Business centre that has recently been renovated.

The site is not allocated as a Major Business/Industrial Estate within the Local Plan and it is recommended to keep the site undesignated for employment use due to the broad mix of non E/B Class uses on the site at present, which would water down the designation. The site is a truly mixed-use site occupied by premises including religious sites and a school. Other uses such as the Robin Hood Gymnastics Club, UK Diamond Drilling Centre and available retail premises indicate a shift away from traditional industrial uses of the site, which is constrained by the proximity of residential uses on all sides.

Arnold Road/Rani Drive (Ref: NCC10)



GROSS SITE AREA:
4.92 ha

ESTIMATED NET DEVELOPABLE AREA:
0 ha

CRITERIA	COMMENT	RATING
<p>Site Context</p> <ul style="list-style-type: none"> • Location with regards to existing employment areas and other sites • How the site fits into the overall portfolio 	<p>The site is approximately 7.8 km north from Nottingham City centre located within the residential suburb of Old Basford. Nottingham City hospital is positioned to the west of the site, with Haydn Road/ Hucknall Road and New Basford industrial Estate further to the south.</p>	
<p>Local Plan Designation</p>	<p>The site has no defined allocations or designations within Nottingham City’s Local Plan. The site borders several patches of open space (Local Plan Policy EN1) and a Mineral Safeguarding Area to the east (Local Plan Policy MI1).</p>	
<p>Status in SHLAA</p>	<p>Site ID: 2257 – 85 Arnold Road, for 12 dwellings. Overall conclusion deliverable. The site has received Prior Approval for 12 dwellings on part of the site.</p>	
<p>Planning History</p>	<p>Recent planning history includes;</p> <ul style="list-style-type: none"> • 20/00935/PACPD – Prior approval application – Change of use from light industrial use (B1) to flats (C3) (8 flats) – Prior approval Granted 23.06.20 • 20/00866/PFUL3 – Full planning application - Partial demolition and external alterations including new external rear wall and recladding of existing front wall and erection of external stairs and balcony access – Granted 23.06.20 	
<p>Current Use and Land Type</p>	<p>The site is divided by the B6004, with predominately a newly constructed industrial unit (subdivided into smaller premises) to the south of the road at Rani Business Park. To the north of the B6004 is a BT Fleet Centre and some additional industrial units with some office accommodation,</p>	

	<p>dated from the early 1990s. Two detached buildings are also located towards the centre of the site, one appears to be vacant.</p> <p>The occupants of the site fall within B2, E and Sui Generis use classes.</p>	
<p>Occupier Profile (if partly developed, including % of available land and levels of vacancy onsite)</p>	<p>Occupiers of the site include:</p> <p>Rani Business Park – Nationwide Windows, DB House, Fastenal, Prime Services, Saint Flooring, Viewtec Signs, Motor Parts Direct, Olivibra UK Ltd, Jones and Co</p> <p>BT Fleet Centre, B+M Steel, Crown Decorating Centre, Terry Cooper Services (supplier of new and used print equipment), CJC Haulage Machinery Removal and Installation, Spreckley Limited, Mary Magdalin Foundation and Charity Shop.</p> <p>A single unit on Rani Drive is advertised to let.</p>	
<p>Strategic Road Access</p>	<p>The site adjoins the B6004 passing through residential areas on route. The A611 (Hucknall Road) is approximately 0.9km to the east.</p>	<p>Poor</p>
<p>Local Road Access</p>	<p>The site adjoins the B6004 passing through residential areas on route.</p>	<p>Average / Poor</p>
<p>Proximity to Urban Areas and Access to Labour and Services (including public transport / cycling / walking accessibility)</p>	<p>The site is located within the residential suburb of Old Basford. The site has good pedestrian infrastructure that connects to the wider area, with the site accessible to multiple food/takeaway premises and convenience retail such as a Nisa Local and Co-operative Food.</p> <p>Three bus stops are located within the site providing services to Bulwell and Nottingham city centre.</p> <p>There is no formal cycle infrastructure within the site.</p>	<p>Good</p>
<p>Compatibility of Adjoining Uses (including amenity impacts experienced by current/future occupiers and neighbouring areas)</p>	<p>The site is bound by residential dwellings on all sides.</p>	<p>Very Poor</p>
<p>Developmental and Environmental Constraints (e.g. size; topography; site access; roads, lighting, landscaping, mains utilities)</p>	<p>The site is an irregular shape, divided by Arnold Road through the centre of the site.</p> <p>A review of Flood Maps for Planning (Gov.uk,</p>	<p>Good</p>

and communications infrastructure; flood risk; contamination; nature and heritage conservation)	2021) and Historic England Listing Map, 2021) shows the site is not located within a flood zone nor does it contain any listed buildings.	
Barriers to Delivery and Mitigation (including ownership constraints - if known)	The site is fully developed with no obvious barriers identified from the site visit.	Very Good
Market Attractiveness (including appropriateness, vacancy and market activity on site for the type of development proposed)	The site has a single unit vacant on Rani Drive (7,061 sq. ft.) at £42,000 p. a. The agent – NG Chartered Surveyors – notes that the property benefits from a low service charge fixed rate at £2,500 p. a. The unit is an end-terraced warehouse constructed of steel frame with steel cladding.	Good
Strategic Fit with Growth Area Objectives (by target Market Segment)	The following industrial growth sectors are already located within the site; <ul style="list-style-type: none"> • Construction • Retail The site is located within the Nottingham 'Regional Centre'.	Average
OVERALL SITE RATING	Average	
Recommendation and Potential Future Uses	<p>Protect the site for employment uses</p> <p>Do not allocate the site as a major business/industrial estate</p> <p>The site is small in scale featuring predominately sub-divided industrial units at Rani Business Park and the BT Fleet Centre. However, the site is an established employment location, has good levels of occupation notwithstanding the prior approval application and should be protected for local employment use.</p>	
SITE SUMMARY:		
<p>The site is approximately 7.8 km north from Nottingham City Centre located within the residential suburb of Old Basford. The site is divided by the B6004, with predominately a newly constructed industrial unit (subdivided into smaller premises) to the south of the road at Rani Business Park. To the north of the B6004 is a BT Fleet Centre and some additional industrial units with some office accommodation, dated from the early 1990s. Two detached buildings are also located towards the centre of the site, one appears to be vacant. The site is not allocated within the Local Plan and given the sites small scale area with limited businesses should not be allocated as a Major Business/Industrial Estate. However, the site is an established employment location, has good levels of occupation notwithstanding the prior approval application and should be protected for local employment use.</p>		

Bar Lane Industrial Estate, Basford Road (Ref: NCC11)



GROSS SITE AREA:
5.56 ha

ESTIMATED NET DEVELOPABLE AREA:
0.11 ha
(former Vedonis factory and office in the north-east of the site)

CRITERIA	COMMENT	RATING
<p>Site Context</p> <ul style="list-style-type: none"> • Location with regards to existing employment areas and other sites • How the site fits into the overall portfolio 	<p>The site is located within the residential suburb of Old Basford, approximately 6.38km from Nottingham city centre. To the immediate east of the site is Bar Lane/Basford Road with New Basford Industrial area located further to the south of the site. Nottingham Trent student accommodation is also located opposite the site along Whitemoor Road. The Maltings accommodation is a Grade II Listed Building (Historic England Map Search, 2021).</p>	
<p>Local Plan Designation</p>	<p>The site is located within a Mineral Safeguarding Area (Local Plan Policy MI1) and an Air Quality Management Area (Local Plan Policy IN2) in the Nottingham City Local Plan.</p> <p>The site borders an Archaeological Constraints Area (Local Plan Policy HE1) to the immediate east, with allotments and designated open space to the north (Local Plan Policy EN1 & EN4, Bar Lane Allotments).</p>	
<p>Status in SHLAA</p>	<p>Site ID: 152 Industrial park, Bar Lar. Overall Conclusion: Not Deliverable or Developable.</p>	
<p>Planning History</p>	<p>Recent planning history includes;</p> <ul style="list-style-type: none"> • 17/01493/PFUL3 – Full planning application – Conversion to 14 apartments – Granted 16.05.18 	
<p>Current Use and Land Type</p>	<p>The site is accessed by two-period gateways from Bar Lane and Whitemoor Road. The main site is dominated by Bar</p>	

	<p>Lane Industrial Park, an early 1900s industrial building now subdivided into smaller workshop units. The units are of a red brick build with slated roof. Within the forecourt of the Industrial park is a derelict building – the former Vedonis factory and offices – dating from 1926 in a dilapidated state, overgrown by vegetation.</p> <p>The Vedonis offices are visible from the kerbside and are architecturally distinguished from the factory through the stone window dressings, the entrance and the mosaic Vedonis sign. The building is Locally Listed (HA516).</p> <p>Overall Bar Lane Industrial Park appears in a generally tired condition.</p> <p>To the south of the site along Basford Road, are two industrial units of modern build with corrugated sheet roofs and modern brick walls. These buildings neighbour several period properties in the site dated 1936, 1899 and a General Baptist Chapel from 1867. These buildings are all in use and are in a good condition. From a review of the Historic England Map (2021) database, none of the above buildings across the site are listed.</p> <p>The occupiers of the site fall within class B2, C3, E and F1(f) uses.</p>	
<p>Occupier Profile (if partly developed, including % of available land and levels of vacancy onsite)</p>	<p>Occupiers of the site include:</p> <p>Basfords Windows, Doors and Conservatories, Stormclad – The Home of Improvements, DAE Mechanical Services Ltd., Basford Road Baptist Church and Sherwood Fabrics</p> <p>Bar Lane Industrial Park – Bar Lane Community Sports Centre</p> <p>Horizon Landscapes, Baltex W. Ball & Son Ltd (dyers and finishers), VeeDubzCamperConversions, Broxap Litterbins CCP, Cnc Cuts Plus, Designer Workshop, Racking Answers Quality Office Supplies Stationary Shop and East Midlands Sewers</p> <p>Innes England advertise units available to let from 3,000 sq. ft. on short term agreements within the Industrial Park.</p>	
<p>Strategic Road Access</p>	<p>The site is bound by local roads on all approaches, with access to the A6514 approximatley 0.8km to the south-east and the A610, 0.8km to the east.</p>	<p>Average / Poor</p>
<p>Local Road Access</p>	<p>The site is accessed from Bar Lane to the north and Basford road to the south. Both roads pass residential areas, including Ellis Guildford School along Bar Lane. Travel along Whitmoor Road is particularly narrow, further constrained by speed humps, a narrow junction and property curtilages</p>	<p>Poor</p>

	immediately adjoining the roadside.	
Proximity to Urban Areas and Access to Labour and Services (including public transport / cycling / walking accessibility)	<p>The site is located within the residential suburb of Old Basford and is in close proximity to a convenience store and hospitality venues.</p> <p>The site is serviced by multiple bus stops on Bar Lane and Percy Street with regular services to Nottingham city centre, Beeston and Bulwell. Basford Tram stop is also located 0.54km to the east of the site, with trams towards Toton Lane.</p> <p>The site does not benefit from any formal cycle infrastructure or pedestrianised walkways within the site. The public pavements surrounding the site ensure walking accessibility to the wider area.</p>	Good
Compatibility of Adjoining Uses (including amenity impacts experienced by current/future occupiers and neighbouring areas)	The site is bound by residential areas to the north, west and south, with student accommodation also located to the east of the site.	Very Poor
Developmental and Environmental Constraints (e.g. size; topography; site access; roads, lighting, landscaping, mains utilities and communications infrastructure; flood risk; contamination; nature and heritage conservation)	<p>The site is generally square in shape and benefits from an open courtyard area within the Industrial Park.</p> <p>A review of Flood Maps for Planning (Gov.uk, 2021) shows the site is not located within a flood zone nor are there any listed buildings within the site. However, the Maltings student accommodation located opposite the site along Whitemoor Road is a Grade II Listed Building (Historic England Map Search, 2021).</p> <p>The former Vedonis factory and offices are Locally Listed (HA516).</p>	Average
Barriers to Delivery and Mitigation (including ownership constraints - if known)	The site is located within a Mineral Safeguarding Area (Local Plan Policy MI1) and an Air Quality Management Area (Local Plan Policy IN2) in the Nottingham City Local Plan.	Average
Market Attractiveness (including appropriateness, vacancy and market activity on site for the type of development proposed)	<p>From the site visit an Innes England marketing sign promoted units to let within the Industrial Park on short term agreements starting from 3,000 sq. ft.</p> <p>The details are unavailable online for these units.</p>	Average
Strategic Fit with Growth Area Objectives (by target Market Segment)	<p>The following industrial growth sectors are already located within the site;</p> <ul style="list-style-type: none"> • Retail <p>The site is located within the 'Regional Centre' of</p>	Average

	Nottingham (as identified in the D2N2 Vision 2030 document).	
OVERALL SITE RATING	Average / Poor	
Recommendation and Potential Future Uses	<p>Allocate for employment uses</p> <p>The site is small in scale featuring predominately sub-divided industrial units in Bar Lane Industrial Park. There are a number of period buildings throughout the site with the industrial estate itself in a generally tired condition. Some of the site's occupants depart from the traditional industrial use of the site including a church and community sports facilities.</p> <p>Whilst the site is in need of improvement, it appears to have a good occupancy rate and serves a local need. Recommend that the site boundary be reviewed to exclude non employment uses. Some renovation of the units required and environmental improvement of the site in general, but it is suggested that the site be protected for employment use, although this should be monitored going forward and kept under review if vacancies increase.</p>	
SITE SUMMARY:		
<p>The site is located within the residential suburb of Old Basford, approximately 6.4 km from Nottingham city centre. To the immediate east of the site is Bar Lane/Basford Road. The main site is dominated by Bar Lane Industrial Park, an early 1900s industrial building now subdivided into smaller workshop units. Within the forecourt of the Industrial park is a derelict building – the former Vedonis factory and offices - from 1926 in a dilapidated state overgrown by vegetation. To the south of the site, along Basford Road, is a General Baptist Chapel and two industrial units of modern build with corrugated sheet roofs and modern brick walls. Overall Bar Lane Industrial Park is in a generally tired condition and is not allocated as a Major Business/Industrial Estate.</p> <p>Given the size of the site, condition of the site and some of the sites occupants departing from the traditional industrial use of the site (such as a church and community sports facilities) it is recommended the site boundary be amended to focus on the employment uses. The site should be allocated for employment use, although this should be monitored going forward and kept under review if vacancies increase.</p>		

Bar Lane/East of Percy Street (Ref: NCC12)

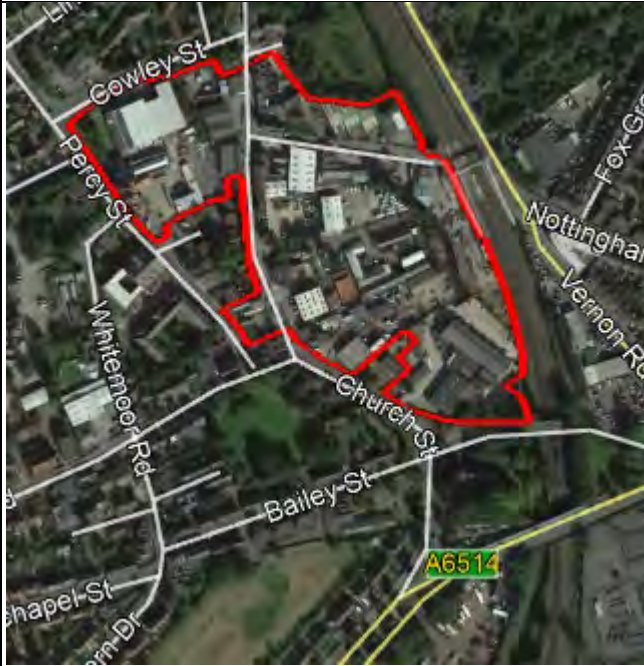

**GROSS SITE AREA:
4.01 ha**

**ESTIMATED NET DEVELOPABLE AREA:
0.20 ha
(for ref.18/01382/PFUL3)**

CRITERIA	COMMENT	RATING
<p>Site Context</p> <ul style="list-style-type: none"> • Location with regards to existing employment areas and other sites • How the site fits into the overall portfolio 	<p>The site is located within the residential suburb of Old Basford, approximately 6.2 km from Nottingham City Centre. To the immediate west of the site is Bar Lane Industrial Estate with New Basford Industrial area located further to the south of the site.</p> <p>The site benefits from accessibility to Basford Tram Stop; the site itself has a mix of business types and accommodates a Grade II listed former brewery from 1881 and several locally listed buildings.</p>	
<p>Local Plan Designation</p>	<p>The site is allocated within the Nottingham City Local Plan as a Major Business Park/Industrial Estate (Local Plan Policy EE2).</p> <p>Other designations include;</p> <ul style="list-style-type: none"> • Archaeological Constraints Area (Local Plan Policy HE1); • Consultation Zone – Hazardous Installations Layer (Local Plan Policy IN3) <p>The River Leen passes the site along its eastern boundary (Local Plan Policy EN5) the river is designated as a Local Wildlife Site (Local Plan Policy EN6, site reference 5/1501). Proposed cycle route improvements are also assigned along the eastern border (Local Plan Policy TR3).</p>	
<p>Status in SHLAA</p>	<p>N/A</p>	

<p>Planning History</p>	<p>Recent planning history includes;</p> <ul style="list-style-type: none"> • 18/01382/PFUL3 – Full planning application - Proposed residential development with an element of retail/commercial at ground floor (amended scheme to include retention of existing building) – Granted 06.01.20
<p>Current Use and Land Type</p>	<p>The site comprises of a mixed-use industrial area with some scattered residential dwellings throughout. Generally, the site appears tired and semi-rundown.</p> <p>The buildings occupying the site are of mixed use and age, built in 1912, early 1990s and early 2000s. Small industrial units are positioned along Nottingham Road and Church Street, generally they are of relatively modern build constructed of red brick with corrugated metal roofing.</p> <p>The site contains a Grade II Listed Building to the west. JJ Murphy and Sons, a former brewery and later chemical factory was constructed in 1881. The building is built of red brick, with terracotta and ashlar dressings. The building has a central brewing tower 5 storeys in height and has a central round arched cart entrance (Historic England Map Search 2021). The adjoining area continue to operate as Murphy and Sons Limited – this is the largest occupier of the site (c.0.91ha)</p> <p>Three locally listed buildings are also present in the site, including the former White Swan Public House (HA93), the former Bowling Green Public House (HA552) and a 3-storey red brick building dated 1883 and is the last remaining evidence of Lincoln Street shops (HA559).</p> <p>The occupiers of the site fall within B2, C3, E and Sui Generis uses.</p>
<p>Occupier Profile (if partly developed, including % of available land and levels of vacancy onsite)</p>	<p>Occupants of the site include:</p> <p>N&J Pitts Taximeter Service, BCW Metals, Murphy and Sons Limited (Brewing suppliers), Battery Store, Lee & Fletcher (Wholesale Coffee), Fox & Crown Pub, Fredk. Johnson Lace Co (Lace Manufacturer), Servatruc – The Forklift People Watts Van Hire, Wheel Refurbs – Sand Blasting Bodyshop Mehran’s Garage, TJ Alloy Welding, Comex2000 (Telecommunications Contractor), Lindleys Autocentre (and MOT centre), D & J Projects Ltd (Landscape Gardner), Bespokee Ltd (Furniture Maker), Woodcock (kitchen and bedroom manufactures), Fortress Gates & Fabrications, Marshall Industrial Supplies Ltd., ETIS Insulation Specialist, Labelserv Ltd. (manufactures of printed fabric and self-adhesive labels), Invicta signs & neon, BJ Control Panels Limited, Clearcomm Group and Sherwood Shed Company.</p>

	The former White Swan Pub is advertised as being to let within the site.	
Strategic Road Access	The A6514 is 0.44km to the south of the site.	Average
Local Road Access	Multiple local roads service various aspects of the site. Turning onto Church Street from Alpine Street is made difficult as a result of a blind and Church Street itself relatively narrow, further constrained by a lack of parking restrictions and vehicles parked within the carriageway	Poor
Proximity to Urban Areas and Access to Labour and Services (including public transport / cycling / walking accessibility)	<p>The site is located within the residential suburb of Old Basford and is in close proximity to a convenience store, hospitality venues and Tesco Express.</p> <p>The site is serviced by bus stops along Percy Street, Alpine Street and Church Street with regular services to Bulwell and Nottingham City Centre. The site is also directly serviced by the tram network, with the Basford Tram Stop adjacent having trams towards Toton Lane.</p> <p>The site has pavements throughout connecting the site to the wider area. Cycle infrastructure is also evident along Church Street, however the lack of parking restrictions throughout the site results in a narrower carriageway.</p>	Good
Compatibility of Adjoining Uses (including amenity impacts experienced by current/future occupiers and neighbouring areas)	The site is bound by the tramline to the east and a local wildlife site to the north-east. Neighbouring the site to the north and north west are residential areas. Several residential dwellings and pubs are pepper potted throughout the site.	Very Poor
Developmental and Environmental Constraints (e.g. size; topography; site access; roads, lighting, landscaping, mains utilities and communications infrastructure; flood risk; contamination; nature and heritage conservation)	<p>Turning onto Church Street from Alpine Street is made difficult as a result of a blind bend and Church Street itself relatively narrow, further constrained by a lack of parking restrictions and vehicles parked within the carriageway.</p> <p>A review of Flood Maps for Planning (Gov.uk, 2021) shows the eastern area of the site is located within a Flood Zone 2 and Flood Zone 3 designation. However, flood defences span along the eastern boundary of the site.</p> <p>The site contains a Grade II Listed Building to the west. JJ Murphy and Sons – former brewery and then chemical factory constructed in 1881</p>	Poor

	(Historic England Map Search, 2021).	
Barriers to Delivery and Mitigation (including ownership constraints - if known)	The site is located within an Archaeological Constraints Area (Local Plan Policy HE1)	Average
Market Attractiveness (including appropriateness, vacancy and market activity on site for the type of development proposed)	The former White Swan Pub is advertised to let within the site by marketing agents HomeAway Property Management. The agent provides limited details but notes the property is available from 9 th December 2020 at a charge of £15,600 p. a. for 1,884 sq. ft. of ground floor office accommodation (including cellar storage).	Average
Strategic Fit with Growth Area Objectives (by target Market Segment)	The following industrial growth sectors are already located within the site; <ul style="list-style-type: none"> • Food & Drink Manufacturing • Construction • Retail • Professional/Business Service <p>The site is located within the 'Regional Centre' of Nottingham (as identified in the D2N2 Vision 2030 document).</p>	Good
OVERALL SITE RATING	Average / Poor	
Recommendation and Potential Future Uses	<p>Allocate for employment uses</p> <p>Amend the site boundary to exclude non-employment uses</p> <p>The site contains several residential properties pepper potted throughout. In addition, application 18/01382/PFUL3 indicates a departure towards additional residential development in the site.</p> <p>Whilst the site is in need of improvement, it appears to have a reasonable occupancy rate and serves a local need. Recommend that the site boundary be reviewed to exclude non employment uses and specifically the residential where practical. Some renovation of the units required and environmental improvement of the site in general, but it is suggested that the site be protected for employment use, although this should be monitored going forward and kept under review if vacancies increase.</p>	
SITE SUMMARY:		
The site is located within the residential suburb of Old Basford, approximately 6.18km from Nottingham city centre. The site is occupied by a range of industrial occupants and is generally in a tired and semi-rundown condition. The buildings within the site include a number of historically significant buildings that are Grade and Locally listed. A number of residential units		

and pubs are also pepper potted throughout the site, with additional residential units to be delivered as part of application 18/01382/PFUL3. Access to the site along local road is notably difficult given a blind bend turning onto Church Street. The street itself is relatively narrow, further constrained by a lack of parking restrictions and vehicles parked within the carriageway.

It is recommended the site boundary be amended to focus on the remaining employment uses. The site should be allocated for employment use, although this should be monitored going forward and kept under review if vacancies increase.

Carlton Road/Stonebridge Road (Ref: NCC13)

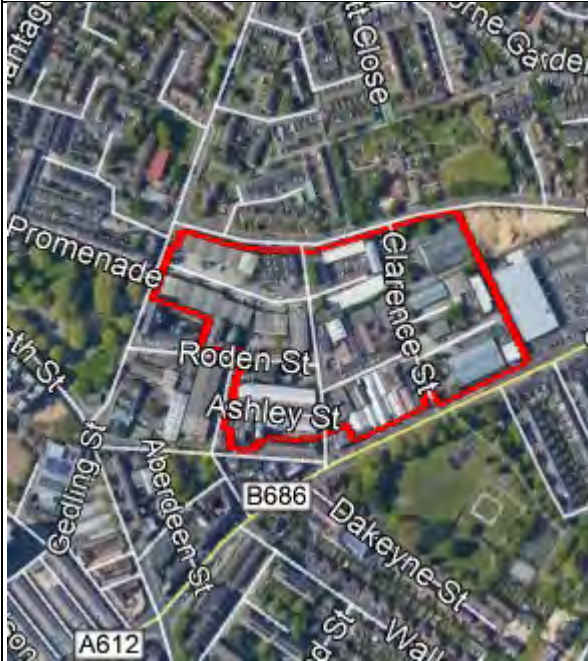

**GROSS SITE AREA:
4.89 ha**

**ESTIMATED NET DEVELOPABLE AREA:
0 ha**

CRITERIA	COMMENT	RATING
<p>Site Context</p> <ul style="list-style-type: none"> • Location with regards to existing employment areas and other sites • How the site fits into the overall portfolio 	<p>The site is positioned just west of Nottingham city centre, adjacent Victoria Park and King Edward Park, within a predominately residential area of the city.</p> <p>To the west, is the Creative Quarter of the city with the site just 0.62km from the Motorpoint Arena and National Ice Centre. The Canal Quarter is further to the south of the site and within 2.3km of Nottingham’s train station.</p>	
<p>Local Plan Designation</p>	<p>The site immediately borders the Sneinton Market Conservation Area and Archaeological Constraints Area (Local Plan Policy HE1). The site is on the border of the City Centre with the site located within a Mineral Safeguarding Area (Local Plan Policy MI1) and Air Quality Management Area (Local Plan Policy IN2). Proposed Cycle Route Improvements are allocated along the southern border of the site (Local Plan Policy TR3, Thorneywood to City)</p>	
<p>Status in SHLAA</p>	<p>Site ID: 511 Albany Works site, Carlton Road. Overall Conclusion: Deliverable, on a small part of the site there is an extant permission (ref. 16/00859/PFUL3).</p>	
<p>Planning History</p>	<p>Recent planning history includes;</p> <ul style="list-style-type: none"> • 16/00859/PFUL3 – Full planning application – New retail unit (mixed use A1/A2/A3) with 8 flats above following demolition of existing building – Granted 23.05.17 	
<p>Current Use and Land Type</p>	<p>A mixed-use site comprising of multiple industrial courts (dated late 1990s/ early 2000s, in a good condition), redbrick workshops 1-2 storeys in height with flat rooves, a</p>	

	<p>youth club in the centre of the site with an oval corrugated roof and tarmacked playing pitches, and two period red brick buildings in use as offices, studio and fitness space. The historic buildings are not listed by Historic England nor locally listed by Nottingham City Council.</p> <p>The site is generally in an average condition, with some damage to buildings, flaking paint and graffiti.</p> <p>The businesses occupying the site fall within Use Classes B2, E, F1(b) and Sui Generis use.</p>	
<p>Occupier Profile (if partly developed, including % of available land and levels of vacancy onsite)</p>	<p>Occupiers of the site include; Winners Gym Limited, Maltmill Motors Car Sales, Ipaint Car body repairs, Backlit Art Gallery & Studios, Kickfit, Carlton Clutch Repair, 3D Autokeys, Russell Youth Club, Timberman Kitchens & Worktop Centre and Fibroz D.I.Y Store.</p> <p>Biz Space – Roden House Business Centre (offices, studios, workshops, storage, virtual offices & mailboxes to rent)</p> <p>Robin Hood Industrial Estate – Omega Windows & Doors Ltd, Harvey Quilting Ltd, VIA East Midlands Ltd, Rainbow Jersey Ltd, TTK Confectionary Ltd, Colorset, Graham Roberts Plastics Ltd, Oversolve Ltd and Crossfit Nottingham Ltd.</p> <p>Stonebridge Court – Reviva Drinks, Luna, Dream Doors (Notts) Ltd., Confetti Constellations, Nottingham City Council, Johal Dairies, Hartech Engineering Ltd, Castle Embroidering Ltd, Perspektiv Ltd, Shamsheer Oriental Foods Ltd.</p> <p>Clarence Court – Johnstone’s Leyland Decorating Centre and Perspektiv Group</p> <p>Garnet Court – Lighting Protection UK Ltd Faraday Chapman Lighting Protection, Aaron Johnson Carpentry & Restoration</p> <p>Several units are unoccupied/vacant including;</p> <ul style="list-style-type: none"> • Robin Hood Industrial Estate – 3 unoccupied • Stone Bridge Court – 1 unoccupied • Clarence Court – 1 unoccupied • Garnet Court – 1 unoccupied 	
<p>Strategic Road Access</p>	<p>The site adjoins Carlton Road (B686), which travels towards the A612 and A6008, 0.8 km to the west.</p>	<p>Average / Poor</p>
<p>Local Road Access</p>	<p>The site adjoins Carlton Road (B686) from the south, if approaching from the north the site is</p>	<p>Average</p>

	accessed via Stone Bridge Road that passes through residential neighbourhoods.	
Proximity to Urban Areas and Access to Labour and Services (including public transport / cycling / walking accessibility)	<p>Located on the border of the City Centre and within a residential area of Nottingham, the site is in very close proximity to hospitality venues, convenience stores and a Lidl supermarket.</p> <p>Multiple bus stops are positioned on the boundary of the site along Robin Hood Street and Carlton Road with regular services to the city centre, Southwell, Carlton, Arnold, Mapperley and Thorneywood. The site is also approximately 1.58km from Lace Tram Stop and 2.3km (c. 18minute walk) from Nottingham's train station, accessible by the wider pedestrian infrastructure. The station provides services to Leeds, Matlock, Worksop, Lincoln Central, Leicester, Skegness, Liverpool Lime Street and London St Pancras International.</p> <p>The site does not benefit from any cycle infrastructure.</p>	Very Good
Compatibility of Adjoining Uses (including amenity impacts experienced by current/future occupiers and neighbouring areas)	<p>The site merges with residential areas and Stonebridge City Farm to the north.</p> <p>Additional residential dwellings immediately border the site, including a substantial number of apartments on Roden Street and several houses on Clarence Street.</p> <p>To the south of the site is King Edward Park with Victoria Park to the west.</p>	Poor / Very Poor
Developmental and Environmental Constraints (e.g. size; topography; site access; roads, lighting, landscaping, mains utilities and communications infrastructure; flood risk; contamination; nature and heritage conservation)	<p>The site is generally rectangular in shape and has a flat, even topography throughout. The site has multiple ingress and egress points for vehicles.</p> <p>A review of Flood Maps for Planning (Gov.uk, 2021) and Historic England Listing Map (2021) shows the site is not within a Flood Zone nor does it contain any listed buildings.</p>	Very Good
Barriers to Delivery and Mitigation (including ownership constraints - if known)	The site is located within a Mineral Safeguarding Area (Local Plan Policy MI1) and Air Quality Management Area (Local Plan Policy IN2).	Average
Market Attractiveness (including appropriateness, vacancy and market activity on site for the type of development proposed)	Despite several vacancies at Stonebridge Court, Clarence Court and Garnet Court, the units are not advertised on the agent's (Property Plus) website.	Average

	<p>NG Chartered Surveyors are the marketing agent for Unit 1 (3,326 sq. ft.) in Robin Hood Industrial Estate. The cost of the unit to let is £21,700 p. a. with the agent describing the site as a centrally located estate that offers a range of good quality industrial units with integral office accommodation.</p> <p>NG Chartered Surveyors also detail that all units in Robin Hood Industrial Estate are undergoing full refurbishment and will benefit from excellent specification including brand new lighting and electric roller shutter doors.</p>	
<p>Strategic Fit with Growth Area Objectives (by target Market Segment)</p>	<p>The following industrial growth sectors are already located within the site</p> <ul style="list-style-type: none"> • Creative & Digital • Retail • Professional/Business Service <p>The site is located within the 'Regional Centre' of Nottingham (as identified in the D2N2 Vision 2030 document).</p>	Good
<p>OVERALL SITE RATING</p>	<p>Average</p>	
<p>Recommendation and Potential Future Uses</p>	<p>Protect the site for employment / mixed use</p> <p>The site contains a mix of uses that depart from the traditional uses of an industrial estate including a youth club, art gallery and fitness spaces. In addition, the site immediately borders residential dwellings including a substantial apartment building on Roden Street. The planning history indicates a further shift away from industrial units to residential led development of the site.</p> <p>However, this is one of the closest industrial sites to Nottingham City Centre, has been popular for many years and has a reasonably high level of occupancy.</p> <p>Given the site's close proximity to the Creative Quarter there is potentially scope for a greater focus on complementary sectors to this area particularly within the visitor economy. This could involve protecting the site for mixed use with an element of employment.</p>	
<p>SITE SUMMARY:</p> <p>The site is positioned just west of Nottingham city centre, adjacent Victoria Park and King Edward Park, within a predominately residential area of the city. To the west, is the Creative Quarter of the city with the site just 0.62km from the Motorpoint Arena and National Ice Centre. The site is occupied by a range of businesses including fitness spaces, art gallery, youth centre and traditional industrial courts and workshops. Overall, the site is in an average condition, with ageing buildings, flaking paint and graffiti.</p>		

The site has a number of residential sites in immediate proximity including a substantial apartment building on Roden Street. Recent planning permission was also granted for additional residential development of the site.

The site is not allocated for employment use at present. With the sites close proximity to the Creative Quarter there is potential scope for a greater focus on complementary sectors to this area particularly within the visitor economy. This could involve protecting the site for mixed use with an element of employment.

Nottingham Business Park (Ref: NCC14)



**GROSS SITE AREA:
22.91 ha**

**ESTIMATED NET DEVELOPABLE AREA:
2.0 ha
(vacant land at the end of Lawrence Drive)**

CRITERIA	COMMENT	RATING
<p>Site Context</p> <ul style="list-style-type: none"> • Location with regards to existing employment areas and other sites • How the site fits into the overall portfolio 	<p>The site is located approximately 11km from Nottingham city centre and strategically located in close proximity to the M1. Following the M1 southbound, Nottingham business park is c.24.7km from East Midlands Airport (an approximate 20-minute drive).</p> <p>The site is also located 3.79km to south-east of Phoenix Park (with the Park providing a park and ride facility and regular tram services to the city centre) with Rolls Royce positioned further to the north (8.3km).</p> <p>Despite the number of high-profile and professional businesses at Nottingham Business Park, the site is not allocated as a Major Business Park / Industrial Estate within the Nottingham City Local Plan as per Local Plan Policy EE2.</p>	
<p>Local Plan Designation</p>	<p>The site falls within the Air Quality Management Area (Policy IN2) and a Mineral Safeguarding Area of (Policy MI1) of the Nottingham City Local Plan. The site is also enveloped by the Greenbelt and designated open space.</p> <p>The northern segment of the site falls within a HS2 Safeguarding Direction allocation (Policy TR2). To the immediate west of the site proposed cycle route improvements are also designated (Local Plan Policy TR3).</p>	
<p>Status in SHLAA</p>	<p>N/A</p>	
<p>Planning History</p>	<p>Recent planning history includes;</p> <ul style="list-style-type: none"> • 15/1693/PRES4 - Substitution of house types previously approved on planning permission reference 	

	<p>14/00335/PRES4 (Plots 46-51, 106-111, 123-124, 172-175, 183-184, 191-195 (BH) and 213-224, 250-255, 265-266, 274-276 (DWH) – Granted – 08.10.15</p> <ul style="list-style-type: none"> • 16/00542/PDS4 - Details submitted to part-comply with condition 13 (materials) of outline planning permission reference 13/01703/POUT - plots 213-216, 217-221, 257 and 287 – Granted – 28.04.16 • 16/01020/PFUL3 - Convenience store (class A1) and pub/restaurant (class A3/A4) with associated access, parking, pedestrian and cycle routes and other related works – Granted – 11.11.16 • 16/02258/PRES4 - Substitution of house types previously approved on planning permission reference 14/00335/PRES4 (plots 208-221, 234-241, 291-294) – Granted - 07.02.17 • 19/02705/PVAR3 - Variation of condition 19 (increase delivery hours from 2200 to 2300) of planning permission reference 16/01020/PFUL3 – Granted – 10.08.20 	
Current Use and Land Type	<p>The site is developed as a residential-led employment site, with modern dwellings of mixed sizes and designs within the southern half of the boundary and employment premises to the north. The employment buildings include a retail and hospitality venue, amongst modern office buildings with some containing lab/research facilities.</p> <p>The buildings within the site fall within the C3 and E.</p>	
Occupier Profile (if partly developed, including % of available land and levels of vacancy onsite)	<p>Occupiers of the site include:</p> <p>East Midlands Ambulance Trust HQ Aldi Holly Tree Farm Pub/Restaurant Source Bioscience Catalent (Pharmaceutical company) Centiq Ltd. (Technology Services) Remit Group (Training Programme Provider) Keepmoat Homes (House Builder) Public Highways England Barratt Homes North Midlands YD Energy Jackson Law Financial Management Limited</p> <p>Advertisement for four new Grade A office buildings from 11,000 sq. ft to 31,000 sq. ft. on vacant land to the north-west of site at the end of Lawrence Drive.</p>	
Strategic Road Access	<p>The site immediately adjoins the A6002 and is approximately 1.6km from the M1 junction.</p>	Good
Local Road Access	<p>Access from the A6002 to the site is from a 4-arm roundabout. Travelling east bound along Chatterley</p>	Very Good

	<p>drive the road adjoins a second roundabout which prevents travel through the residential area when navigating towards the offices in the north.</p> <p>A second access road on the A6002 onto Princess Boulevard allows immediate access to the residential area of the site.</p>	
<p>Proximity to Urban Areas and Access to Labour and Services (including public transport / cycling / walking accessibility)</p>	<p>The site is located 11km from Nottingham City Centre and has good road connectivity to the motorway. The site is directly serviced by buses with regular services to the city centre and Assarts Farm.</p> <p>As a newly constructed site the area has a particularly good public realm, including pedestrian connectivity around the site with shared cycleways. A lightly gravelled public footpath designed for shared recreational use, connects the site to Swingate, Kimberely, Strelley and Bilborough.</p> <p>The site is also located approximately 3.8 km to south-east of Phoenix Park (with the Park providing a park and ride facility and regular tram services to the city centre).</p>	Average
<p>Compatibility of Adjoining Uses (including amenity impacts experienced by current/future occupiers and neighbouring areas)</p>	<p>The site is relatively isolated and is bound by agricultural land to the north, west and south with the A6002 separating the business park from residential neighbourhoods to the east.</p> <p>Beyond the land to the east is the M1.</p>	Good
<p>Developmental and Environmental Constraints (e.g. size; topography; site access; roads, lighting, landscaping, mains utilities and communications infrastructure; flood risk; contamination; nature and heritage conservation)</p>	<p>The site is generally rectangular shape with flat topography. Ingress and egress to and from the site is of the A6002 either via a four-armed roundabout that avoids the residential area or Princess Boulevard.</p> <p>As a newly constructed site, the site benefits from good landscaping and public realm.</p> <p>A review of Flood Maps for Planning (Gov.uk, 2021) and Historic England Listing Map (2021) shows the site is not located within a Flood Zone nor does it contain any listed buildings.</p> <p>The northern part of the site is sterilised by the HS2 safeguarded route.</p>	Average
<p>Barriers to Delivery and Mitigation (including ownership constraints - if known)</p>	<p>The site falls within the Air Quality Management Area (Policy IN2) and a Mineral Safeguarding Area of (Policy MI1) of the Nottingham City Local Plan.</p> <p>A clear barrier to development on the vacant land to the north west of the park, at the end of Lawrence</p>	Very Poor

	Drive is that the lands falls within the HS2 Safeguarding Direction allocation (Policy TR2).	
Market Attractiveness (including appropriateness, vacancy and market activity on site for the type of development proposed)	<p>An advisement sign for the development of four new Grade A office buildings from 11,000 sq. ft. to 31,000 sq. ft. on vacant land to the north west of the park, at the end of Lawrence Drive (c. 2.0 ha)</p> <p>The site is advertised by FHP, Cushman & Wakefield and Wilson Bowden. There are no additional details about the site online.</p> <p>Policy TR2 safeguards this area of land for HS2.</p>	Good
Strategic Fit with Growth Area Objectives (by target Market Segment)	<p>The following industrial growth sectors are already located within the site;</p> <ul style="list-style-type: none"> • Life Sciences • Retail • Health/Social Care • Professional/Business Service <p>The site is located within the 'Regional Centre' of Nottingham (as identified in the D2N2 Vision 2030 document).</p>	Very Good
OVERALL SITE RATING	Good	
Recommendation and Potential Future Uses	<p>Allocate for employment uses</p> <p>Amend site boundary to exclude the residential / retail areas and allocate the remainder of the site as a major business/industrial estate</p> <p>The site is a purpose-built mixed-use development containing a number of high profile and national brands that fall within many of the industrial growth sectors targeted by D2N2. The site is fully occupied and is strategically located within close proximity to the M1.</p>	
SITE SUMMARY:		
<p>The site is located approximately 11km from Nottingham City Centre and strategically located in close proximity to the M1. Following the M1 southbound, Nottingham business park is c.24.7km from East Midlands Airport (an approximate 20-minute drive).</p> <p>The site has been developed as a residential-led employment site, with modern dwellings of mixed sizes and designs within the southern half of the boundary and employment premises to the north. The employment buildings include a retail and hospitality venue, amongst modern office buildings with some containing lab/research facilities. Some of the businesses in occupation include East Midlands Ambulance Trust HQ, Aldi, Source Bioscience, Catalent (Pharmaceutical company), Keepmoat Homes (House Builder), Public Highways England and Barratt Homes North Midlands.</p> <p>An advisement sign for the development four new Grade A office buildings from 11,000 sq. ft. to 31,000 sq. ft. is also placed on vacant land to the north west of the park. However, a clear barrier to</p>		

development of this area of land is that it is safeguarded for HS2 purposes (Policy TR2). Given the above characteristics of the site with many of the occupiers falling within the industrial growth sectors targeted by D2N2 the site should be allocated for employment uses with the boundary amended to exclude the residential / retail areas and allocate the remainder of the site as a major business/industrial estate.

Queens Drive (Ref: NCC15)



**GROSS SITE AREA:
6.41 ha**

**ESTIMATED NET DEVELOPABLE AREA:
0 ha**

CRITERIA	COMMENT	RATING
<p>Site Context</p> <ul style="list-style-type: none"> • Location with regards to existing employment areas and other sites • How the site fits into the overall portfolio 	<p>The site is located within the immediate vicinity of Nottingham City Centre on the border of the Canal Quarter; consequently, the site benefits from walkable accessibility and direct tram connectivity to the amenities within the city including Nottingham train station, 0.9 km to the east.</p> <p>The site is opposite Castle Marina Retail Park (to the north) and neighbours NG2 business park and Queens Drive Industrial Estate to the south-west. Further to the west is the University of Nottingham, King's Meadow Campus, approximately 1.77km away.</p> <p>The site is undesignated as a Major Business Park / Industrial Estate within the Nottingham City Local Plan as per Local Plan Policy EE2.</p>	
<p>Local Plan Designation</p>	<p>The site falls within the Air Quality Management Area (Policy IN2) and a Mineral Safeguarding Area of (Policy MI1) of the Nottingham City Local Plan.</p>	
<p>Status in SHLAA</p>	<p>N/A</p>	
<p>Planning History</p>	<p>Recent planning history includes;</p> <ul style="list-style-type: none"> • 14/02061/PFUL3 - Construction of retail unit, car showroom with associated workshop and office block including link to existing data centre – Granted – 16.01.15 	
<p>Current Use and Land Type</p>	<p>The site is occupied by four key buildings including a homewares shop, a data centre and Castle Park – a modern rectangular metallic industrial unit subdivided into smaller units.</p>	

	The businesses occupying the site fall within B8 and E use classes .	
Occupier Profile (if partly developed, including % of available land and levels of vacancy onsite)	<p>Occupiers of the site include: Dunelm Data centre Castle Park – CEP, Arco Limited (suppliers of safety equipment), Sliderobes (custom built fitted wardrobes), J Van Vliet (Nottingham) Limited (wholesale flowers & plants), VIA East Midlands Limited (Civil Engineering Depot), Deciem – The Abnormal Beauty Company, March Bellofram Europe Limited, Eurocell Building Plastics Limited, 3 Line Electrical Wholesale Limited and Mr Clutch Autocentres Limited</p> <p>Castle Park has three units available to let: Unit 1, 23,992 sq. ft., Unit 2, 9,505 sq. ft., and Unit 10, 4,273 sq. ft.</p> <p>Currently a patch of land within the centre of the site is under construction for use as a car showroom.</p>	
Strategic Road Access	The site immediately adjoins the A453, Queens Drive via a traffic light junction.	Average
Local Road Access	Access is direct from the A453 with all buildings having ancillary parking to the properties.	Very Good
Proximity to Urban Areas and Access to Labour and Services (including public transport / cycling / walking accessibility)	<p>The site is located within the immediate vicinity of Nottingham City Centre on the border of the City's Canal Quarter. The pedestrian infrastructure of the site connects to the wider area including to the facilities within the city centre. The train station is approximately an 11-minute walk from the site, with trains towards Cardiff Central, London St Pancras International, Leeds, Worksop, Lincoln Central, Norwich, Leicester, Liverpool Lime Street and Birmingham New Street.</p> <p>The site benefits from multiple bus stops servicing the site with regular buses towards the city centre, Wollaton and Boots HQ. Immediately opposite the site is Meadows Way Tram stop with trams travelling towards Toton Lane and Hucknall. A shared pedestrian cycleway is also present along Queens Drive.</p>	Very Good
Compatibility of Adjoining Uses (including amenity impacts experienced by current/future occupiers and neighbouring areas)	The site is bound by an active railway line to the north with Queens Drive and Meadows Way to the south, although residential units are located further south.	Good
Developmental and	The site is rectangular in shape with level	Average /

<p>Environmental Constraints (e.g. size; topography; site access; roads, lighting, landscaping, mains utilities and communications infrastructure; flood risk; contamination; nature and heritage conservation)</p>	<p>topography throughout.</p> <p>A single ingress and egress point is positioned in the centre of the site, the access road directly adjoins the A453 via a traffic light junction.</p> <p>A review of Flood Maps for Planning shows the majority of the site is located within a Flood Zone 3 but is an area benefiting from flood defences.</p> <p>The site does not contain any listed buildings (Historic England Listing Map, 2021).</p>	<p>Good</p>
<p>Barriers to Delivery and Mitigation (including ownership constraints - if known)</p>	<p>The site is located within the Air Quality Management Area (Policy IN2) and a Mineral Safeguarding Area of (Policy MI1) of the Nottingham City Local Plan.</p>	<p>Average</p>
<p>Market Attractiveness (including appropriateness, vacancy and market activity on site for the type of development proposed)</p>	<p>Three units are available to let at Castle Park:</p> <ul style="list-style-type: none"> • Unit 1 – 23,992 sq. ft. (rateable value £87,500) • Unit 2 – 9,505 sq. ft. (rateable value £37,750) • Unit 10 – 4,273 sq. ft. (rateable value £18,500) <p>(Units 1 and 2 can be combined)</p> <p>The units are advertised by Commercial Property Partners who described the development as “<i>offering an efficient working environment</i>” with onsite parking.</p> <p>Key features of the units include integrated offices and wc, loading doors and eaves height of 6.8m.</p>	<p>Good / Average</p>
<p>Strategic Fit with Growth Area Objectives (by target Market Segment)</p>	<p>The following industrial growth sectors are already located within the site:</p> <ul style="list-style-type: none"> • Retail • Creative & Digital • Construction <p>The site is located within the ‘Regional Centre’ of Nottingham (as identified in the D2N2 Vision 2030 document).</p>	<p>Average</p>
<p>OVERALL SITE RATING</p>	<p>Good</p>	
<p>Recommendation and Potential Future Uses</p>	<p>Protect the site for employment uses / mixed use</p> <p>The site is undesignated as a Major Business/Industrial estate and it is recommended to not allocate the site. Queens Drive is small in scale occupied by just a few buildings, including a</p>	

retail only premises, with limited potential for expansion.

However, this is one of the closest industrial sites to Nottingham City Centre, has been popular for many years and has a reasonably high level of occupancy and should be protected for employment uses going forward.

SITE SUMMARY:

The site is located within the immediate vicinity of Nottingham City Centre on the border of the Canal Quarter. The site is also opposite Castle Marina Retail Park (to the north) and neighbours NG2 business park and Queens Drive Industrial Estate to the south-west. The site is occupied by a homewares shop, a data centre and Castle Park (industrial unit subdivided into smaller premises). The site is undesignated as a Major Business Park/Industrial Estate within the Nottingham City Local Plan (Local Plan Policy EE2), given the size of the site and its limited potential for expansion it is recommend the site is not allocated as a Major Business Park/Industrial Estate, but should nevertheless be protected for employment uses / mixed use going forward.

Riverside/Lenton Lane (Boots/Abbeyfield Road - Boots Site) (Ref: NCC 16)



**GROSS SITE AREA:
75.39 ha**

**ESTIMATED NET DEVELOPABLE
AREA:
13.97 ha
(based on the areas identified for
employment uses in the masterplan)**

CRITERIA	COMMENT	RATING
<p>Site Context</p> <ul style="list-style-type: none"> • Location with regards to existing employment areas and other sites • How the site fits into the overall portfolio 	<p>The site is located at the edge of Beeston, immediately neighbouring the boundaries of Broxtowe.</p> <p>The site is approximately 7.0 km south-west of Nottingham City Centre. To the north-east is the University of Nottingham’s main campus and the site itself forms part of the larger Boots HQ.</p> <p>The site is also part of a larger employment area comprising of Evelyn Street and Padge Road (to the north), Riverside/Lenton Lane industrial area (to the west) and Lilac Road (to the east).</p> <p>In total, there are three designated Enterprise Zones across Nottingham, of which the Boots site is one of the three designated zones. The vision for the site is to create a UK centre for innovation in health, beauty and wellness (D2N2).</p>	
<p>Local Plan Designation</p>	<p>The site is allocated as a development site (Local Plan Policy SA1, site reference SR45) for 200-260 dwellings, 2,500-6,500 sqm of office space and between 5-15 ha of industrial/warehousing units.</p> <p>The site is also designated as an Enterprise Zone and a Major Business/Industrial Estate (Local Plan Policy EE2)</p> <p>Other site designations include;</p>	

	<ul style="list-style-type: none"> • Air Quality Management Area (Policy IN2) • Mineral Safeguarding Area (Local Plan Policy MI1) <p>The Beeston Canal runs through the north-east segment of the site (Local Plan Policy EN5); the canal itself is also designated as a Local Wildlife Site (Policy EN6).</p>
Status in SHLAA	Site ID: 458 Boots, Thane Road. Overall conclusion: Deliverable for 230 dwellings.
Planning History	<p>The following applications relate to land immediately south of the site off Thane Road:</p> <p>At Nottingham City Council Planning Committee Meeting on the 17th December 2014 it was resolved to grant outline planning permission (ref. 14/02038/POUT) for mixed-use development comprising: up to 82,000 sqm of employment floorspace, comprising office units (E), research and development (E), industrial process (E), general industrial (B2), storage and distribution (B8), residential institutions (C2) & non-residential institutions (D1), up to 2,500sqm retail & food/drink (A1, A2, A3, A4 and A5), up to 675 residential units (C3), and associated works including demolition of existing structures, earthworks, remediation, access, car parking, pedestrian and cycle routes, open space, utilities and sustainable drainage systems.</p> <p>Detailed planning permission (ref. 14/02039/PFUL3) was also granted in December 2014 for site and public infrastructure works including highways (primary vehicle link route, Alliance Boots vehicle access), new canal bridge, associated demolition works, earthworks, remediation, utilities and drainage infrastructure. This has been implemented and the new road is complete and subject to adoption.</p>
Current Use and Land Type	The site forms part of the wider Boots national headquarters site for class E, B2 and B8 use . In March 2011, the Boots site was awarded Enterprise Zone status by the UK Government.
Occupier Profile (if partly developed, including % of available land and levels of vacancy onsite)	<p>The site is occupied by Boots. DHL occupy building D82 and lead Boots' national logistics operation from here. Alliance Healthcare occupy building D80, they are the Pharmaceutical Wholesale Division in Walgreens Boots Alliance.</p> <p>Building D94 is currently occupied by Boots although they no longer need the space and are seeking to let it out. It is a two-storey detached building set in its own landscaped grounds and comprising of approximately 2,939 sqm of office space, undercroft storage and ancillary accommodation. It has been on the market for over a year.</p> <p>Building D31 is vacant and has been for 15 years. It</p>

	<p>comprises of the former site canteen and recreational facilities and has potential for use as a conference centre. It comprises of approximately 10,684 sqm.</p> <p>Whilst outwith the site boundary, Building D98 is also vacant. It is located within Plot E1 (in the north west adjacent to Humber Road South) which is identified as a potential first phase of development for employment uses under planning application ref. 14/02038/POUT.</p> <p>Parcels of land within the site are identified for development for employment uses under planning application ref. 14/02038/POUT. These areas include:</p> <ul style="list-style-type: none"> • E13, E14 and E15 to the east of the site comprise of existing open space. It is proposed that parcels E13 (4.62ha, GFA 22,240 sqm) and E14 (1.03ha, GFA 4,967 sqm) will comprise use class B8 and parcel E15 (0.55ha) will comprise use class B2 (GFA 2,664 sqm). • E16 (4.61ha) comprising of storage space to the rear of Building D82 will comprise of use class B8 (GFA 11,107 sqm). • E12 (1ha) comprising of open space to the south of Building D82 will comprise of 4,810 sqm (GFA) of use class B2 space. • E7 (1.4ha), E8a (0.7ha) and E8b (0.06ha) comprise of car parking areas to the south of the site immediately north of the new access road. It is proposed that parcel E7 will comprise of 9,083 sqm (GFA) of health and wellness space, parcel E8a will comprise of 2,285 sqm (GFA) of E use class (offices) and 1,693 sqm (GFA) of B2 use class. It is proposed that parcel E8b will comprise of 288 sqm (GFA) of B2 floorspace. <p>Employment areas E1, E2, E3, E4, E5 and E6 are outside of the site boundary although within the wider Boots site. The proposals also include new areas of car parking and incorporation of the existing energy centre as well as areas of existing and new green space.</p>	
<p>Strategic Road Access</p>	<p>The site is accessible from the A52 Clifton Boulevard to the east. The western area of the site can be accessed off a 4-armed roundabout off Humber Road South via the Beeston Gate. Humber Road South adjoins the A6005 c.048 km to the north.</p>	<p>Average</p>
<p>Local Road Access</p>	<p>The Boots site can be accessed off the A52 Clifton Boulevard to the east via the Thane Road gate. HGV access to the site is to the north via Clifton Boulevard then Redfield Road/Harrimans Lane and the Harrimans Lane gate. The western portion of the wider site can also be accessed off Humber Road South via the Beeston Gate.</p>	<p>Very Good</p>

<p>Proximity to Urban Areas and Access to Labour and Services (including public transport / cycling / walking accessibility)</p>	<p>Boots Campus is approximately 2.0km from Beeston Town Centre, which contains national retail and eatery brands such as a Tesco Extra and Sainsbury's.</p> <p>The site is pedestrianised throughout and connects into the wider area. The pedestrian infrastructure is also shared with a cycleway on exit from the site. The site is also in relatively close proximity to Beeston Railway Station (approximately 1.64km to the west) providing services to Birmingham New Street, St Pancras International, Matlock, Newark Castle, Lincoln, Cardiff Central, Leicester and Nottingham.</p> <p>There are bus stops within the site on C Road and Fifth Avenue with services every 10 minutes to Nottingham. There are also bus stops on Lilac Grove with services to Nottingham every 10 minutes as well as to Beeston and Stapleford. University Boulevard Tram Stop is also approximately 1km north of the site.</p>	<p>Very Good</p>
<p>Compatibility of Adjoining Uses (including amenity impacts experienced by current/future occupiers and neighbouring areas)</p>	<p>The site forms part of the wider Boots HQ site. The site is bound by an active railway line to the north and the wider Riverside/Lenton Lane industrial area to the east. To the west there is the wider Boots site and the Lilac Grove Sewage Treatment Works beyond. To the south there is development land with the recently completed road and bridge across the Beeston Canal beyond.</p>	<p>Very Good</p>
<p>Developmental and Environmental Constraints (e.g. size; topography; site access; roads, lighting, landscaping, mains utilities and communications infrastructure; flood risk; contamination; nature and heritage conservation)</p>	<p>This site comprises of the eastern portion of the wider Boots site. It has utilities and telecommunications infrastructure in place, there is also an onsite power station which heats and cools the campus via a high-pressure steam system.</p> <p>On this site the Boots D90 West Headquarters building is Grade II* Listed (ref. 1268303). Adjacent to the site, the D6 Building (occupied by MediCity) and the D10 Building (occupied by BCM) are both Grade I Listed (ref. 1278028, 1247927, respectively). Building D34, the former fire station, is also Grade II Listed (ref. 1247933) (Historic England Listing Map, 2021).</p> <p>The Beeston Sidings Local Nature Reserve (ref. 1009534) is located immediately north of the railway line.</p> <p>The site is adjacent to the Beeston Canal and the majority of the site is within "Flood Zone 3 Areas benefitting from flood defences". Therefore, there is a high probability of flooding in this location</p>	<p>Average / Poor</p>

	albeit flood defences are in place. Some of the eastern portion of the site is within Flood Zone 2.	
Barriers to Delivery and Mitigation (including ownership constraints - if known)	The site is previously developed and there is an extant planning permission for development of existing parking, storage and open areas for employment uses (application ref. 14/02038/POUT). The site benefits from Enterprise Zone status.	Very Good
Market Attractiveness (including appropriateness, vacancy and market activity on site for the type of development proposed)	The site is fully occupied by Boots and a number of related healthcare manufacturing and logistics businesses. Although Building D94 is currently occupied by Boots they are seeking to let it out as they no longer require the space. The agent, Innes England, describes the property as a purpose-built two storey detached office. The offices are of high-quality HQ offices with 80 dedicated parking spaces. In total 31,631 sq. ft. of office space is available (31,631 sq. ft. upper ground floor and 18,803 sq. ft. on the lower ground floor). The tenure is available on a new lease for a term of years to be agreed. Rent for the property is only available upon application.	Very Good
Strategic Fit with Growth Area Objectives (by target Market Segment)	The following industrial growth sectors are already located within the site: <ul style="list-style-type: none"> • Health/Social Care The site is located on the border of the Nottingham 'Regional Centre' (as identified in the D2N2 Vision 2030 document). It is an Enterprise Zone and a key site for Nottingham City.	Very Good
OVERALL SITE RATING	Very Good	
Recommendation and Potential Future Uses	Allocate for employment uses Retain current Local Plan designation as a major business/industrial estate As a notable employer within the region the Boots site should be allocated for employment use in accordance with the adopted masterplan. Furthermore, the other healthcare manufacturing and research and development businesses located on this section of the Boots site should be protected.	
SITE SUMMARY:		
The site is located on the edge of Beeston, immediately neighbouring the boundaries of Broxtowe. The site is occupied by Boots. DHL occupy building D82 and lead Boots' national logistics		

operation from here. Alliance Healthcare occupy building D80, they are the Pharmaceutical Wholesale Division in Walgreens Boots Alliance. Building D94 is currently occupied by Boots although they no longer need the space and are seeking to let it out. The site is allocated as a development site (Local Plan Policy SA1, site reference SR45) for 200-260 dwelling, 2500-6500 sqm of office space and between 5-15ha of industrial/warehousing units.

Given the historic and continued use of the site as Boots HQ, the allocated mixed-use development and Enterprise Zone status it is recommended the site is allocated for employment uses and retain its designation as a Major Business/Industrial Estate.

Riverside/Lenton Lane (Abbeyfield Road - East of Beeston Canal) (Ref: NCC17)



**GROSS SITE AREA:
44.38 ha**

**ESTIMATED NET DEVELOPABLE AREA:
6.77 ha
(vacant land)**

CRITERIA	COMMENT	RATING
<p>Site Context</p> <ul style="list-style-type: none"> • Location with regards to existing employment areas and other sites • How the site fits into the overall portfolio 	<p>The site is located on the western outskirts of Nottingham City Centre, bound by the A52 on its eastern boundary and the Beeston Canal meandering along the western border.</p> <p>To the north-west is the University of Nottingham’s main campus and the pharmaceutical retail chemist group Boots has its headquarters to the immediate east. The site forms part of the larger Riverside/Lenton Lane employment area.</p> <p>Beyond the site’s borders, to the north are multiple hospitality venues, a disused club, Poker Club, art-deco styled cinema with extensive parking. This area presents an opportunity for expansion of this already established employment area.</p>	
<p>Local Plan Designation</p>	<p>The site is designated as a Major Business Park/Industrial Estate (Local Plan Policy EE2) within the Nottingham City Local Plan. The majority of the site is also allocated as a development site (Local Plan Policy SA1, site reference SR46) for B1, B2 and B8 use that compliments and strengthens the existing employment character of the area.</p> <p>Other designations include;</p> <ul style="list-style-type: none"> • An open space corridor along the western boundary of the site (Local Plan Policy EN1), adjacent the Beeston Canal (Local Plan Policy EN5 which is also designated as a Local Wildlife Site (Policy EN6). • Air Quality Management Area (Policy IN2). • Proposed cycle route improvements along the west of the site (Local Plan Policy TR3) 	

Status in SHLAA	N/A
Planning History	<p>Recent planning history includes;</p> <ul style="list-style-type: none"> • 15/03078/PFUL3 - Conversion and extensions to create motor vehicle dealership for sale, service and MOT of motor vehicles – Granted – 22.02.16 • 16/00852/PFUL3 - Redevelopment to provide car dealership with showroom, workshop, used car showroom/office, ancillary parking and associated works – Granted – 08.08.16 • 16/00887/PFUL3 - Two storey car showroom and associated works – Granted – 14.09.16 • 16/02289/PVAR3 - Redevelopment to provide car dealership with showroom, workshop, used car showroom/office, ancillary parking and associated works. Variation of condition S1 plans of planning application ref: 16/00852/PFUL3 to increase the Used Car Showroom footprint and building height, reduce the workshop footprint and associated alterations – Granted – 22.12.16 • 18/01455/POUT - Outline application for the development of up to 46,556 sqm of B1, B2 and B8 industrial space, up to 12,115 sqm for a potential car showroom (use class Sui Generis) and with all matters reserved, except consideration of access – Granted – 02.12.19
Current Use and Land Type	<p>The employment area is dominated by car dealerships from luxury brands to second-hand autos. This is complemented by a specialist vehicle parts and technology company occupying several units of the site. Parts of the site are also in use as a wholesalers, factory and recycling centre. The units occupying the site are predominately large industrial units, with the car dealerships in particular designed with attractive glass frontages and car forecourts for the display of vehicles. The buildings are in a good condition and are of a modern build.</p> <p>The occupants of the site fall within B2, B8, E and Sui Generis uses.</p>
Occupier Profile (if partly developed, including % of available land and levels of vacancy onsite)	<p>Occupiers of the site include:</p> <p>Zf (Vehicle Parts and testing specialists), Arnold Clark Megastore (Vehicle Sales), Hypermania Wholesale, Millennium Packaging Limited, J K Foods, Ready Steady Store, Sunbelt Rentals Plant and Tools, Household Waste and Recycling Centre, Ford Transit Centre Nottingham, Mazda Dealer, Sandcliffe Used Cars Nottingham, Sandcliffe Nissan Dealer, Greenwoods Stock Boxes, Nottingham Audi Dealer, Keir, Nottingham Recycling, Aston Martin Nottingham, Baxter Freight and LeenGate Metals Limited</p> <p>Thyssenkrupp offices - ACMS UK (software company) 360 Recruitment, CR Code Red Associates</p>

	<p>Imperial Tobacco Factory, Horizon Factory and Regional Distribution Centre.</p> <p>A large parcel of flat, cleared land is vacant (c.6.77ha) towards the south-west of the site. The site is allocated for employment development within the adopted local plan (site reference, SR46).</p>	
Strategic Road Access	The site immediately adjoins Clifton Boulevard (A52) via Redfield Road junction, with immediate connectivity to Clifton Boulevard interchange to the south of the site. The interchange provides direct access to the A453 (Queens Drive).	Average
Local Road Access	Redfield road connects the site to the A52 to the north-east of the site with Thane Road providing access to Clifton Boulevard Interchange to the south.	Very Good
Proximity to Urban Areas and Access to Labour and Services (including public transport / cycling / walking accessibility)	<p>The site is located on the western outskirts of the city centre, with good pedestrian infrastructure around the site. A pedestrian bridge also ensures safe accessibility to the east, across Clifton Boulevard. To the immediate north are several food premises including Chiquito, Nandos, Five Guys and Frankie and Benny's.</p> <p>The site is also within a walkable distance (c.1.32km) of University Boulevard to the west where a tram stop (The University of Nottingham Tram Stop) is located. The stop provides services to Hucknall, Toton Lane and Nottingham train station in the city centre.</p> <p>The site does not benefit from any cycle infrastructure and is directly serviced by a single bus stop adjacent Abbeyfield road. The stop provides regular services to Arnold and Queens Medical Centre. Additional bus stops are located across Clifton Boulevard, on Lenton Lane, with regular buses to the city centre and Clifton.</p>	Very Good
Compatibility of Adjoining Uses (including amenity impacts experienced by current/future occupiers and neighbouring areas)	<p>The site is bound by the A52 to the east and Thane Road to the south.</p> <p>To the west is Beeston Canal with "out of town" hospitality and leisure premises to the north.</p>	Very Good
Developmental and Environmental Constraints (e.g. size; topography; site access; roads, lighting, landscaping, mains utilities and communications infrastructure; flood risk; contamination; nature and heritage conservation)	<p>The site has an irregular shape with flat topography throughout. The site also has good ingress and egress points from the A52.</p> <p>Beeston Canal (Local Plan Policy En5) which runs along the western boundary is designated as an open space corridor (Local Plan Policy EN1) and a Local Wildlife Site (Policy EN6).</p>	Average

	<p>A review of Flood Maps for Planning (Gov.uk, 2021) shows the entire site is located within a Flood Zone 2. The Canal itself is designated as a Flood Zone 3 but benefits from flood defences.</p> <p>The site does not contain any listed buildings, in addition the Imperial Tobacco, Horizon Factory and Regional Distribution Centre has a certificate of immunity (Historic England Listing Map, 2021).</p>	
<p>Barriers to Delivery and Mitigation (including ownership constraints - if known)</p>	<p>The site is located within an Air Quality Management Area (Policy IN2).</p>	<p>Average</p>
<p>Market Attractiveness (including appropriateness, vacancy and market activity on site for the type of development proposed)</p>	<p>The site is fully occupied, albeit a patch of vacant land (6.77ha) to the south-west of the site which is allocated for industrial development (ref. SR46, for B1, B2 and B8 uses) within the Local Plan.</p>	<p>Very Good</p>
<p>Strategic Fit with Growth Area Objectives (by target Market Segment)</p>	<p>The following industrial growth sectors are already located within the site:</p> <ul style="list-style-type: none"> • Transport Equipment Manufacturing • Retail • Creative & Digital • Retail • Professional/Business service <p>The site is located within the 'Regional Centre' of Nottingham (as identified in the D2N2 Vision 2030 document).</p>	<p>Good</p>
<p>OVERALL SITE RATING</p>	<p>Good</p>	
<p>Recommendation and Potential Future Uses</p>	<p>Allocate for employment uses</p> <p>Retain current Local Plan designation as a major business/industrial estate</p> <p>The site is an established industrial estate and forms part of the wider employment area. The site has an active planning history which indicates continued interest in the site for employment use. Similarly, a vacant area of land within the site is allocated for additional employment development in order to strengthen and compliment the already established use and this policy designation should remain.</p>	
<p>SITE SUMMARY:</p>		
<p>The site is located on the western outskirts of the city centre, bound by the A52 on its eastern boundary and the Beeston Canal meandering along the western border. The site forms part of the wider Riverside/Lenton Lane employment area, with other employment areas such as the University of Nottingham, Nottingham Science & Technology Park and the pharmaceutical retail chemist group Boots HQ to the north-west.</p> <p>The employment area is dominated by car dealerships from luxury brands to second-hand autos. This is complemented by a specialist vehicle parts and technology company occupying several units</p>		

of the site. Part of the site is also in use as a wholesalers, factory and recycling centre.

The site is an established industrial estate with planned designations for additional employment premises on vacant land to the south-west of the site. Given the above site characteristics the site should be allocated for employment uses and retain its allocation as a Major Business/Industrial Estate.

Riverside/Lenton Lane (Abbeyfield Road - Harrimans Lane Area) (Ref: NCC18)



**GROSS SITE AREA:
19.03 ha**

**ESTIMATED NET DEVELOPABLE AREA:
0 ha**

CRITERIA	COMMENT	RATING
<p>Site Context</p> <ul style="list-style-type: none"> • Location with regards to existing employment areas and other sites • How the site fits into the overall portfolio 	<p>The site is located on the western outskirts of the city centre, bound by the Beeston Canal meandering along the eastern border, an active railway line to the north and the pharmaceutical retail chemist group Boots has its headquarters on the south-east border. The site itself forms part of the larger Riverside/Lenton Lane employment area.</p> <p>Immediately to the north-west is Nottingham Science and Technology Park with the University of Nottingham's main campus beyond. King's Campus is also located 0.72km to the west of the site.</p>	
<p>Local Plan Designation</p>	<p>The site is designated as a Major Business Park / Industrial Estate (Local Plan Policy EE2) within the Nottingham City Local Plan. The site borders the Beeston Canal (Local Plan Policy EN5) along the entire eastern boundary. The canal is also designated as a Local Wildlife Site (Local Plan Policy EN6), and an open space corridor (Local Plan Policy EN1) on the opposite bank.</p> <p>To the north of the site, along Gibbons Street, a regular square-shaped area of land is designated as an Archaeological Constraints Area (Policy HE1). The site is also located within an Air Quality Management Area (Policy IN2) and proposed cycle route improvements are designated for routes around the site (Local Plan Policy TR3)</p>	
<p>Status in SHLAA</p>	<p>N/A</p>	
<p>Planning History</p>	<p>No recent planning history to note.</p>	
<p>Current Use and Land Type</p>	<p>The site is primarily occupied by industrial units, some with</p>	

	<p>ancillary offices. The units are generally of corrugated metallic build varying in height from 1-3 storey, some units used as offices are constructed of red brick with corrugated sheet rooves. Part of the site is also in use for metal recycling.</p> <p>The buildings were constructed in the late 1990s/early 2000s and are generally in a good condition. However, heading north along Gibbons street the buildings start to age and are in a poor/tired condition.</p> <p>The occupants of the site fall within class B2, E and Sui Generis uses.</p>	
<p>Occupier Profile (if partly developed, including % of available land and levels of vacancy onsite)</p>	<p>Occupiers of the site include: McIntrye Recycling Systems, Makro and Booker Wholesaler, Ross Care, Hireforce Tool Hire centre, EPMS supplies Ltd., Western Power Distribution, Innovation Lifts, Butt Foods, Authentic Bread Co., Fathomtree Limited, Nottingham Bearing Co., Tennant Rubber, LB Foster (automated and materials handing solutions), Lenton Lane Brewery, SIMS Metal Management, Parts Plus, Rock Pecker, Prodression Ltd Corporate & Safety Work, Breedon Nottingham Dunkirk Concrete Plant, A.H. Garner Ltd. Hydraulic Cylinders, Fabriweld, B&S Tyres and car spares, CMEC (Demolition, Asbestos Removal, Skip Hire, Waste Management) and Repair MyCar</p> <p>Acorn Park Estate – Paramount Fork Trucks, Hireforce, Bravo Lighting, Metalmark Engineering Ltd., Laser Expertise, Carboard Paper Plastics Recycling Ltd., AH Garner Ltd.</p> <p>A single detached industrial of 8,499 sq. ft. is available to let within the site.</p>	
<p>Strategic Road Access</p>	<p>The site adjoins Clifton Boulevard (A52) via Redfield Road, approximately 1km to the west.</p>	<p>Average / Good</p>
<p>Local Road Access</p>	<p>Redfield Road connects the site to the A52. Both Cavendish Street and Gibbons Street are no-through Roads with access restricted along Harrimans Lane towards Boots HQ.</p>	<p>Very Good</p>
<p>Proximity to Urban Areas and Access to Labour and Services (including public transport / cycling / walking accessibility)</p>	<p>The site is located on the western outskirts of the city centre. To the immediate west and across Beeston Canal, are several food premises including Chiquito, Nandos, Five Guys and Frankie and Benny's. This area is accessible via good pedestrian infrastructure. There are no immediate retailers such as a Tesco or Sainsburys near the site.</p>	<p>Very Good</p>

	<p>Pedestrian infrastructure also connects the site to Nottingham Science and Technology Park, with further access to the University of Nottingham Tram Stop located on University Boulevard approximately 0.89km to the north west. The trams provide services to Nottingham train station in the city centre, Hucknall and Toton Lane.</p> <p>The site is not directly serviced by buses; however, a bus stop serves Nottingham Science and Technology Park with bus routes towards Nottingham city centre, QMC, the University, Rylands, Beeston, Bramcote and Stapleford. There are no cycleways constructed within the site.</p>	
<p>Compatibility of Adjoining Uses (including amenity impacts experienced by current/future occupiers and neighbouring areas)</p>	<p>The site is bound by Beeston Canal to the east, an active trainline to the north and Boots HQ to the south.</p>	<p>Very Good</p>
<p>Developmental and Environmental Constraints (e.g. size; topography; site access; roads, lighting, landscaping, mains utilities and communications infrastructure; flood risk; contamination; nature and heritage conservation)</p>	<p>The site is triangular in shape and is relatively level throughout with Redfield Road sloping gradually into the site. Ingress and egress to the site is only possible from Redfield Road.</p> <p>Beeston Canal (Local Plan Policy EN5) which runs along the eastern boundary is designated as an open space corridor (Local Plan Policy EN1) and a Local Wildlife Site (Policy EN6).</p> <p>A review of Flood Maps for Planning (Gov.uk, 2021) shows the majority of the site is located within a Flood Zone 3 but benefits from flood defences. A small patch of the site to the south east is designated within Flood Zone 2.</p> <p>The site does not contain any listed buildings (Historic England Listing Map, 2021).</p>	<p>Average</p>
<p>Barriers to Delivery and Mitigation (including ownership constraints - if known)</p>	<p>The site is located within an Air Quality Management Area (Policy IN2).</p>	<p>Average</p>
<p>Market Attractiveness (including appropriateness, vacancy and market activity on site for the type of development proposed)</p>	<p>The site is fully occupied, albeit a detached industrial unit to let of 8,499 sq. ft.</p> <p>The unit is advertised with Heb chartered surveyors and is available for B1/B8 use. The property has a two-storey office, kitchenette and WC facilities and car parking to the front.</p>	<p>Very Good</p>

	The rent is £39,500 p. a. and the building is currently under offer.	
Strategic Fit with Growth Area Objectives (by target Market Segment)	<p>The following industrial growth sectors are already located within the site;</p> <ul style="list-style-type: none"> • Food & Drink Manufacturing • Construction • Retail • Health/Social Care <p>The site is located within the 'Regional Centre' of Nottingham (as identified in the D2N2 Vision 2030 document).</p>	Good
OVERALL SITE RATING	Good	
Recommendation and Potential Future Uses	<p>Protect for employment uses</p> <p>Retain current Local Plan designation as a major business/industrial estate</p> <p>The site is an established industrial estate and forms part of the wider employment area. The site is fully occupied with one vacant unit, already under offer.</p>	
SITE SUMMARY:		
<p>The site is located on the western outskirts of the city centre, bound by the Beeston Canal meandering along the eastern border, an active railway line to the north and the pharmaceutical retail chemist group Boots has its headquarters on the south-east border. The site itself forms part of the larger Riverside/Lenton Lane employment area. Immediately to the north-west is Nottingham Science and Technology Park with the University of Nottingham's main campus beyond. King's Campus is also located 0.72km to the west of the site.</p> <p>The site is primarily occupied by industrial units, some with ancillary offices. The site is fully occupied albeit a single industrial unit is vacant however this is already under offer. As an established site which forms part of a wider employment area and in close proximity to other employment sites, the site should be protected for employment uses and retain its allocation as a Major Business/Industrial Estate.</p>		

Riverside/Lenton Lane (former Wilford Power Station) - Lenton Lane
(Ref: NCC19)



GROSS SITE AREA:
62.90 ha

ESTIMATED NET DEVELOPABLE AREA:
5.57 ha

CRITERIA

COMMENT

RATING

Site Context

- Location with regards to existing employment areas and other sites
- How the site fits into the overall portfolio

The site is located to the south-west of Nottingham City Centre, the site is divided into two segments, separated by the University of Nottingham King's Meadow Campus and an active train line. Access between the two areas is facilitated by transit along Lenton Lane running parallel with the A52.

The site itself forms part of the larger Riverside/Lenton Lane employment area with Queens Drive Industrial Area neighbouring the site to the east and the East of Beeston Canal designation to the west, beyond the A52. The University of Nottingham's main campus and Queens Medical centre are located further to the north-west, with Boots HQ also located to the west.

Local Plan Designation

The site is allocated as a Major Business Park / Industrial Estate (Local Plan Policy EE2) within the Nottingham City Local Plan.

An area of land (2.3ha) along Tottle Road / Queens Drive is also allocated as a development site (Local Plan Policy SA1, site reference SR44, Electric Avenue) for 4,400 sqm of office floorspace or light industrial (B1) use. Any forthcoming development on this current vacant area of land must be conscious of Conservation Area (Wilford Village, Policy HE1) and Archaeological Constraints designation on the opposite river bank.

Other designations within the site include;

- Some patches of open space network to the north of the site and a few scattered to the south (Local Plan

	<p>Policy EN1)</p> <ul style="list-style-type: none"> • Minerals Safeguarding Area (Local Plan Policy MI1) • Air Quality Management Area (Policy IN2) • Proposed Cycle Route Improvements along the river and north of Lenton Lane (Local Plan Policy TR3)
Status in SHLAA	N/A
Planning History	<p>Recent planning history includes;</p> <ul style="list-style-type: none"> • 18/01047/PFUL3 - Extension of existing industrial building. New build office four storey office building. New build store – Granted – 10.08.18
Current Use and Land Type	<p>The site is a very large employment area with various businesses and uses. The north-west of the site is dominated by a model/hobbyist business including shop, offices, factories and distribution centre. To the north-east are modern prime warehouse buildings of red-brick build (Easter Park). The southern half of the site – Lenton Lane Industrial Estate - is occupied by multiple vehicle retailers fronting Lenton Lane. Within the central area of the site are a number of large and typical corrugated industrial buildings and industrial court.</p> <p>There are limited vacancies except for a former depot within the site that appears vacant – an area approximately 3.27 ha in size. The site is not cleared, the former depot remains and is merely fenced off.</p> <p>The occupants of the size fall within class B2, B8, E and Sui Generis uses.</p>
Occupier Profile (if partly developed, including % of available land and levels of vacancy onsite)	<p>Occupiers of the site include:</p> <p>Games Workshop Headquarters and Warhammer World (model/hobbyist business with offices, two factories and 'Eurohub' depot), Brooks Bros and Showroom (Timber) Nottingham Textile Group including Nottingham Textiles, A.C. Gill Limited, Lion Haircare and Palmhive Technical Textiles</p> <p>Trent Fireplaces, Paul Smith (corporate offices), Ten Wealth Management (financial advisor), Aquinas Education (job centre)</p> <p>SellCar</p> <p>Easter Park Lenton Lane – University of Nottingham, Cable & Wireless; THUS, Holmatro UK, Andrew Page The Auto Part People, CEATA – Canal Eng. Training Academy, GAP Ltd, Furniture Vilalge Distribution, MB Nottingham, City Plumbing Supplies, GAP Group Hire Solutions, Reydon Sports, Visual Packaging and GAP Group Hire Solutions.</p> <p>Siemens, Cash 4 Clothes, Macfarlane Packaging, Self-Storage RS Local Nottingham, Tyre City, Pizza Factory, Honda, Ferrari and Maseratti, Canal Engineering, Plumbase, Sytner Group –</p>

	<p>Accident Repair Centre, BMW/Mini, Trementsode Fixings – Suppliers to The Construction Industry and Allied Trades, Warlord games (science fixture miniatures), Libra Drinks, Snowdon Research and Innovation Experian, Land Rover Nottingham, TNT Depot, Scania Truck Dealer Outdoor Scene Clothing and Equipment Shop, Vision Express Retail Tech Centre, Wolseley, St. James’s Place Wealth Management Nottingham and Government Offices.</p> <p>Phoenix Court - Hydraquip Hose Hydraulics, N1 Visual Solutions, GM Environmental Ltd., Vanda Design Limited and Watts Industrial Tyres Ltd.</p> <p>The site contains two vacant/unoccupied units including:</p> <ul style="list-style-type: none"> • KRCS Building (2,452) sq. ft. • Unit 3 Phoenix Court. 	
Strategic Road Access	The site immediately adjoins the A52 (Clifton Boulevard) and the A453, Queens Drive (access to the eastern area of the site only).	Average
Local Road Access	Lenton Lane acts as the preliminary skeleton road through the site. Within the northern area of the site, the road is shared with the tramline. Access to the eastern area of the site only is along Tottle Road. This adjoins Queens Drive via a traffic light junction.	Very Good
Proximity to Urban Areas and Access to Labour and Services (including public transport / cycling / walking accessibility)	<p>The site is located to the south-west of Nottingham city centre. The site has good pedestrian infrastructure which connects to the wider area, including accessibility to local convenience shops and hospitality premises c.1.1km to the north-west. A pedestrian bridge enables accessibility over the A52, this unites the site with the neighbouring employment area to the west. A canal path is also accessible from the site with connectivity to the King’s Meadow nature reserve.</p> <p>The site is also very well serviced by buses, with multiple stops located throughout the site. The buses provide services to Lenton Lane Industrial Estate, Castle Marina Retail Park, Nottingham station, the City Hospital, Boots and Clifton.</p> <p>Immediately to the north-west of the site is Gregory Street Tram stop with tram routes towards Hucknall and Toton Lane.</p>	Very Good
Compatibility of Adjoining Uses	The site is bound by the A52 (Clifton Boulevard) to	Very Good

<p>(including amenity impacts experienced by current/future occupiers and neighbouring areas)</p>	<p>the west and the A453 (Queens Drive) to the south-east.</p> <p>To the north is Queens Drive Industrial Estate with the River Trent to the east.</p> <p>The neighbouring bank falls within a Conservation Area (Wilford Village, Policy HE1) and Archaeological Constraints allocation.</p>	
<p>Developmental and Environmental Constraints (e.g. size; topography; site access; roads, lighting, landscaping, mains utilities and communications infrastructure; flood risk; contamination; nature and heritage conservation)</p>	<p>The site is one of the largest employment areas within the City. It is irregular in shape and is slightly disjointed with a north and south divide forced by an active trainline running through the site. Lenton Lane rises over the track connecting the two areas together. The eastern area of the site is only accessible from Queens Drive, turning onto Tottle Road.</p> <p>A review of Flood Maps for Planning (Gov.uk, 2021) shows the entire site is located within a Flood Zone 2. The site also borders a Flood Zone 3 (which benefits from flood defences) to the immediate north-west. Flood defences are positioned along the majority of the canal and along Queens Drive.</p> <p>The site does not contain any listed buildings (Historic England Listing Map, 2021).</p>	<p>Average</p>
<p>Barriers to Delivery and Mitigation (including ownership constraints - if known)</p>	<p>The SR44 allocation is underlain by a principal aquifer, any forthcoming development should not result in pollution of the groundwater resource. Proposals for the allocation should have regard to the presence of heritage assets located on the east bank of the River Trent.</p> <p>Given the sites flood risk the application must be accompanied by a site specified Flood Risk Assessment (Local Plan Part 2, adopted January 2020).</p> <p>The site is also located within an Air Quality Management Area (Policy IN2).</p>	<p>Average</p>
<p>Market Attractiveness (including appropriateness, vacancy and market activity on site for the type of development proposed)</p>	<p>The site has high levels of occupation throughout.</p> <p>There are two units within the site that are vacant/unoccupied, these include;</p> <ul style="list-style-type: none"> • KRCS Building (2,452) sq. ft. • Unit 3 Phoenix Court. <p>KRCS is marketed by Innes England and has been on the market for the past 2 months. The property provides an industrial and showroom accommodation arranged over two floors, with a</p>	<p>Very Good</p>

	<p>kitchenette and WC facilities. The unit is available to let for £23,000 p.a.</p> <p>A former depot within the site that appears also vacant – an area approximately 3.27ha in size.</p>	
<p>Strategic Fit with Growth Area Objectives (by target Market Segment)</p>	<p>The following industrial growth sectors are already located within the site;</p> <ul style="list-style-type: none"> • Food & Drink Manufacturing • Life Sciences • Creative & Digital • Logistics & E-commerce • Retail • Professional/Business Service <p>The site is located within the 'Regional Centre' of Nottingham (as identified in the D2N2 Vision 2030 document).</p>	<p>Very Good</p>
<p>OVERALL SITE RATING</p>	<p>Good</p>	
<p>Recommendation and Potential Future Uses</p>	<p>Allocate for employment uses</p> <p>Retain current Local Plan designation as a major business/industrial estate</p> <p>The site is one of the largest employment areas within the studies portfolio with limited vacancies throughout the site. There is a large number of business premises located throughout from a game/hobbyist HQ, car showrooms to food manufacturer. The businesses also fulfil many of the industrial growth sectors targeted by D2N2.</p>	
<p>SITE SUMMARY:</p> <p>The site is located to the south-west of Nottingham City Centre, the site is divided into two segments, separated by the University of Nottingham King's Meadow Campus and an active train line. The site is one of the largest employment areas within the studies portfolio with limited vacancies throughout. A former depot within the site appears to be vacant (approximately 3.27 ha) which has some potential to be redeveloped for last mile logistics development. A second vacant area within the site is allocated for 4,400 sqm of office floorspace or light industrial (B1) employment use.</p> <p>Given the site's size, it has a large number of business premises located throughout including a game/hobbyist HQ, car showrooms to food manufacturer. These businesses fulfil many of the industrial growth sectors targeted by D2N2. The site should therefore be allocated for employment uses and retained as a Major Business/Industrial Estate.</p>		

Riverside/Lenton Lane Riverside (former Wilford Power Station)/Lenton Lane - Queens Drive Industrial Estate (Ref: NCC20)



**GROSS SITE AREA:
23.56 ha**

**ESTIMATED NET DEVELOPABLE AREA:
0 ha**

CRITERIA	COMMENT	RATING
<p>Site Context</p> <ul style="list-style-type: none"> • Location with regards to existing employment areas and other sites • How the site fits into the overall portfolio 	<p>The site is located to the south-west of Nottingham City Centre, positioned to the west of Queens Drive (A453) and the River Trent. To the west of the site is the Lenton Lane Industrial area and University of Nottingham’s King’s Meadow Campus. Queen’s Medical Centre is approximately 2.69km to the north-west.</p> <p>The site itself forms part of the larger Riverside/Lenton Lane estate which comprises of industrial areas and Boots’ HQ. The River Leen, to the north, separates the site from NG2 Business Park.</p>	
<p>Local Plan Designation</p>	<p>The site is designated as a Major Business Park/Industrial Estate (Local Plan Policy EE2) within the Nottingham City Local Plan.</p> <p>Other designations include:</p> <ul style="list-style-type: none"> • Open space network (Birdcage Walk) along the northern boundary and slightly along the southern boundary (Local Plan Policy EN1) • River Leen bordering the north of the site, and a small waterbody intruding along the southern border (Local Plan Policy EN5). • The River Leen is also a designated Local Wildlife Site (Policy EN6), the allocation slightly infringes across the northern boundary of the site. A second Local Wildlife Site is positioned to the west of the Site (King’s Meadow Grassland). • Air Quality Management Area (Policy IN2) • Mineral Safeguarding Area (Local Plan Policy MI1) • Proposed Cycle Route improvements along the river 	

	(Local Plan Policy TR3)	
Status in SHLAA	N/A	
Planning History	No recent planning history to note.	
Current Use and Land Type	<p>The site is in use as a typical industrial site, built along Longwall Avenue and Crossgrate Drive. The predominant building type comprises of 2-storey bricked industrial buildings and workshops with metal sheet corrugated rooves. There are several large food processing factories with ancillary offices.</p> <p>The occupiers of the site generally fall within B2, B8, E and Sui Generis uses.</p>	
Occupier Profile (if partly developed, including % of available land and levels of vacancy onsite)	<p>Occupiers of the site include: Protrade Depot – Tools & Fixings, Howdens Joinery Co., Tool Station, The Pizza Factory, Blackburn Starling (sheetmetal fabrication), Addo Food Group – Tottle Bakery, Benchmark Kitchens and Joinery, FedEx, Concept 2 (rowing company) Directflues, Travis Perkins, East Midlands Foods Ltd Cash and Carry, National Windscreens, Hydropath Technology Clifton Bathrooms, Micheldever Tyre Services, Blinds 2 Go, Daltons Wadkin, Cliniwaste Health South Ltd (Treatment & Recycling Facility), PTS Plumbing Trade Supplies, Gibbs & Dandy Timber BSS Nottingham (Pipe Supplier), Ocean Designs Ltd, RW Refrigeration Wholesale Ltd., Jimminson Packaging Services Ltd. Faspak (Containers) Ltd., APN Display, Citysprint UK Ltd. Arriva Transport Solutions, ERS Medical, Parker Motor Services Ltd, Quadrant Events Ltd., Speedy Services (equipment and tool hire) Nottingham Superstore, Huber Group, Blinds 2 Go Ltd, The BSS Group Plc, Parker Merchanting Ltd, Central Lab V.E. Ltd John E Wright & Co, CCL Veloduct Ltd, Invarmant Ltd, Riverside Bakery, Rexel, Vision Express and Hertz.</p> <p>The site is nearly fully occupied with just two units vacant on the site (Unit 10 on Longwall Avenue to let, 5,102 sq. ft. and a second unit, to let, 13,929 sq. ft.). (<i>Note: since visiting the site in December 2020, these premises are no longer listed on the agent's website.</i>)</p> <p>A third unit at 2,832 sq. ft. remains vacant.</p>	
Strategic Road Access	<p>The site immediately adjoins Queens Drive (A453) via a traffic light junction on Crossgrate Drive. A single ingress only junction is also positioned adjacent Dunsil Drive.</p>	Average

Local Road Access	The site immediately adjoins Queens Drive (A453)	Very Good
Proximity to Urban Areas and Access to Labour and Services (including public transport / cycling / walking accessibility)	<p>The site is in relatively close proximity (c.1.31km) to Castle Marina Retail Park. The park has multiple retail and hospitality premises such as a McDonalds, Costa Coffee, Pizza Hut, Sainsbury's and Lidl supermarket. Access to the retail park is possible from good pedestrian infrastructure and pathways. The paths also connect the site to NG2 Business Park in the north (c.0.5km). NG2 Business Park benefits from the NG2 Tram stop with tram services to Toton Lane and Hucknall.</p> <p>The site adjoins an established cycle network with routes towards the Meadows, The Big Track, West Bridgford and Clifton. Two bus stops are positioned towards the front of the site, along Queens Drive with services to the City Centre.</p>	Very Good
Compatibility of Adjoining Uses (including amenity impacts experienced by current/future occupiers and neighbouring areas)	<p>The site is bound by Queens Drive to the east and borders the River Leen to the north. The river itself is a designated Local Wildlife Site (Policy EN6) with a second Local Wildlife Site positioned to the west of the site (King's Meadow Grassland). Along the northern boundary and slightly along the southern boundary form part of the open space network (Local Plan Policy EN1).</p> <p>To the west is a strip of vegetated corridor that separates the site from the wider Riverside/Lenton Lane industrial area.</p>	Very Good
Developmental and Environmental Constraints (e.g. size; topography; site access; roads, lighting, landscaping, mains utilities and communications infrastructure; flood risk; contamination; nature and heritage conservation)	<p>The site is oval in shape with flat topography throughout. The road network within the site forms an 'X' axis. The site has good ingress and egress via a signalised junction of Crossgate Drive.</p> <p>A review of Flood Maps for Planning (Gov.uk, 2021) shows the entire site is located within a Flood Zone 2, with some of the bordering River Leen designated as a Flood Zone 3. The river, however, benefits from flood defences.</p> <p>The site does not contain any listed buildings (Historic England Listing Map, 2021).</p>	Average
Barriers to Delivery and Mitigation (including ownership constraints - if known)	The site is located within an Air Quality Management Area (Policy IN2) and Mineral Safeguarding Area (Local Plan Policy MI1).	Average
Market Attractiveness (including appropriateness, vacancy and market activity on site)	The site is nearly fully occupied with just two units vacant on the site (Unit 10 on Longwall Avenue to	Very Good

<p>for the type of development proposed)</p>	<p>let, 5,102 sq. ft. and a second unit, to let, 13,929 sq. ft.). However, since visiting the site, these premises are no longer listed on the agent's website (Innes England)</p> <p>A third unit at 2,832 sq. ft. remains vacant. This is advertised LCP, with rent and rate information provide on application.</p> <p>LCP describes Queen's Drive Industrial Estate as being in one of Nottingham's most popular locations.</p>	
<p>Strategic Fit with Growth Area Objectives (by target Market Segment)</p>	<p>The following industrial growth sectors are already located within the site;</p> <ul style="list-style-type: none"> • Food & Drink Manufacturing • Construction • Retail • Health/Social Care <p>The site is located within the 'Regional Centre' of Nottingham (as identified in the D2N2 Vision 2030 document).</p>	<p>Good</p>
<p>OVERALL SITE RATING</p>	<p>Good</p>	
<p>Recommendation and Potential Future Uses</p>	<p>Protect for employment uses</p> <p>Retain current Local Plan designation as a major business/industrial estate</p> <p>The site is an established and sizeable industrial estate forming part of the wider employment area. Given the site's longevity and the many of the current businesses fulfilling the industrial growth sectors targeted by D2N2 in a popular location of the city, the site should retain its allocation as a Major Business/Industrial Estate.</p>	
<p>SITE SUMMARY:</p>		
<p>The site is located to the south-west of Nottingham city centre, positioned to the west of Queens Drive (A453) and the River Trent. To the west of the site is the Lenton Lane Industrial area and University of Nottingham's King's Meadow Campus. The site itself forms part of the larger Riverside/Lenton Lane employment area which comprises of industrial areas and Boots HQ. Queens Drive Industrial Estate contains a mix of business premises including food manufacturing units, trade counters and postage depot. The occupants fulfil multiple industrial growth sectors targeted by D2N2 and is in a popular location of the City. Given the above characteristic the site should be protected for employment uses and retain its allocation as a Major Business/Industrial Estate.</p>		

New Basford Industrial Estate (Mount Street/Duke Street) (Ref: NCC21)

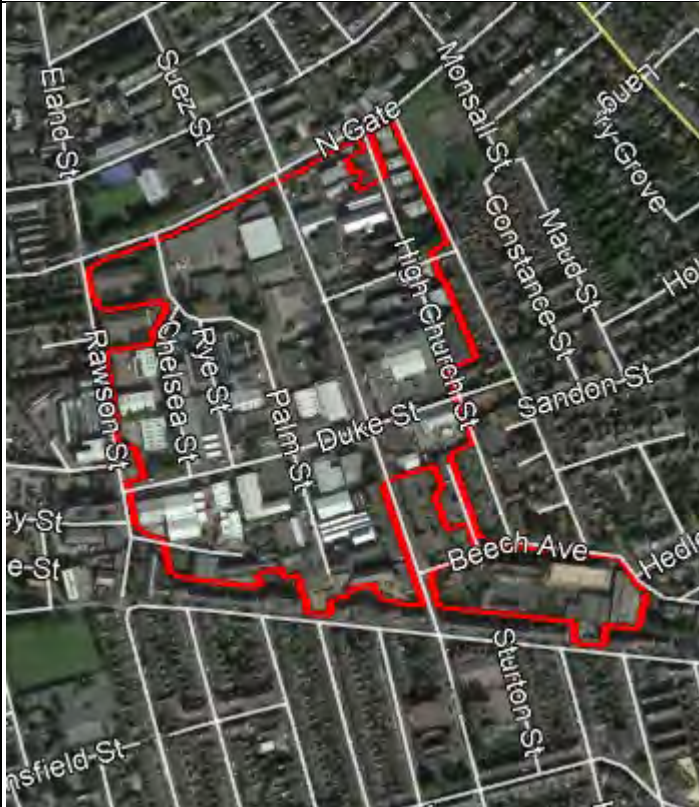

**GROSS SITE AREA:
11.16 ha**

**ESTIMATED NET DEVELOPABLE
AREA:
0 ha**

CRITERIA	COMMENT	RATING
<p>Site Context</p> <ul style="list-style-type: none"> • Location with regards to existing employment areas and other sites • How the site fits into the overall portfolio 	<p>The site is located in New Basford, approximately 4.4km to the north-west of Nottingham city centre. The site – formally named the New Basford Business Area - borders residential neighbourhoods, with New Basford Industrial Estate (Radford Road/North Gate) to the west and Wilkinson Street Tram depot beyond. The site is quite rundown in places and includes a large derelict period factory (Guy Birkin Lace) on Beech Avenue to the south east of the site.</p> <p>In respect of other employment areas, the site is 1.23km south-west of Haydn Road/Hucknall Road, and 1.72km south-east of Bar Lane/Basford Road. The site itself would benefit from redevelopment/renovation.</p>	
<p>Local Plan Designation</p>	<p>The site is designated as a Major Business Park / Industrial Estate (Local Plan Policy EE2) within the Nottingham City Local Plan and immediately borders a Conservation Area (Star Buildings, Policy HE1) to the west. The site itself is located within an Archaeological Constraints Area (Palm Street, Policy HE1).</p> <p>The site is also subject to the following designations;</p> <ul style="list-style-type: none"> • Caves (PA1 – Old Public House, Air Raid Shelter, ND2 – Cellar, DE1 – Former White Horse Public House) • Mineral Safeguarding Area (Local Plan Policy MI1) • Air Quality Management Area (Policy IN2) 	

	<ul style="list-style-type: none"> Proposed Cycle Route Improvements (Local Plan Policy TR3), along Rawson Street.
Status in SHLAA	<p>Site ID: 2018 Mayfair Court, North Gate (site area 0.26ha) (previous application 13/0189/PACPD)</p> <p>Site ID: 2004 No Limits House, Unit 2, Guy Birkin Place, Beech Avenue (site area 0.03ha) (previous application 13/01893/PACPD)</p>
Planning History	<p>Recent planning history includes;</p> <ul style="list-style-type: none"> 14/00712/PFUL3 - Conversion to 48 apartments and alterations – Granted – 24.09.15 (unimplemented) 18/01998/PFUL3 - Conversion from office (B1) and recording studio (D2) to 31 residential apartments (C3) – Granted – 18.04.19 (implemented) 18/02040/PFUL3 - Conversion of warehouse unit from community centre (D1) to 12 residential apartments (C3). Erection of 4 new build houses on car park – Granted – 15.04.19
Current Use and Land Type	<p>New Basford Business area predominately comprises of approximately 79 small industrial workshops set in a mix of period buildings dating from 1872; industrial courts of single storey with garage door entrances built in the early 2000s; and several larger industrial units constructed in the late 1990s.</p> <p>Overall, many of the buildings and the site in general are in a relatively poor and tired condition with a former factory in the site in a derelict state (c.0.80 ha). An area of land (c. 0.17ha) within the centre of the site is also used as a storage area for scrapped vehicles and is informally advertised as having parking spaces to let.</p> <p>The occupiers of the site fall within the B2, B8, E and F1(f) premises.</p>
Occupier Profile (if partly developed, including % of available land and levels of vacancy onsite)	<p>Occupiers of the site include:</p> <p>Capatex (supplier and manufacture of technical textiles and medical products), Heronridge (air conditioning and refrigeration), Trade Ventillation Supplies Ltd, Nationwide Refrigeration Supplies Ltd, John P Waterhouse Co Ltd, M & G Hooper Ltd, A C Electrical Wholesale Plc, Plastic Building Materials Ltd, Advance Tool Hire & Sales Ltd, Pannell Signs Ltd, J A Baddeley & Co Ltd, Ian Nuthall, Scooby Mania, Bar Lane Motor Company, M & G Hooper Ltd, Ego Direct, Heatseal Designs Ltd, Hawthornes Printers, Central Shopfitters Ltd, Forest Graphics, G S Mahal & Co Ltd, Murofast Dyers & Finishers Ltd., Adam House, Pannell Signs Ltd, F C Curran Ltd, Tennants UK Ltd, Klasix Textile Screenprint Ltd., Sharon of Nottingham, Bagfast Limited, KEP Engineering Ltd, TW Eaton & Co Ltd, Deltec International Ltd, Diamond Despatch Ltd, Elm Tree Garage</p>

	<p>Ltd, Ter Mate Ltd, Jones Drinks, Lodge Tyre Co Ltd, Classic Doors & Windows Ltd, Heatseal Windows – E.Y.G., Pompadour, Studio 4, Djanogly Studios, Renamo UK, Dentsys Ltd, Kelly Group, Contract Packaging Services, John Fox Ltd, JWL (Architectural Ironmongers) Ltd, Industrial Gear Repairs N.E.S. Ltd, Gangotra Enterprise Ltd, A La Carte Business Services Ltd, T K Engineering & Gearcutting, Denman Manufacturing Ltd, Smiths Auto Services, Richard Lloyd Motor Engineers, Terry Robinson – Motor Body Repairs, L & J Motors, L A Fabrique, Interknit UK Ltd, D T R Distribution, Air Tools & Compressors Ltd, Sidhu Fashions, Jigsaw Systems Ltd, Lewis Kirk & Elson Engineering Ltd, Edale Narrow Fabrics, A1 Japanese Autoparts, R Clothing Manufacturing, Roulstone Weighing Machines, Pathlore Ltd, Framework Housing, R P Word Models Ltd, Pendragon, South Herts Plant Hire Ltd., New Vision Church, SGR Bodywork Specialists, Tennants UK Highway Equipment, YNC your Next Car Ltd, G & W Smart Repairs, New & Used Tyres, Henoc Garage, Picharch Lloyd Motor Engineers, Ariva George, Mughal Flavours, V3 Power, Creative Flavours Catering Ltd. And Edible Blossoms., Aerial Painters, Heron Ridge Services (Nottingham Ltd.), DANZ Limited, Ventillation Systems (Midlands) Ltd., M&G Hooper Ltd, Advance, Electric Centre, JAYPLAS Building Support and Advanced Hire & Sales Ltd.</p> <p>Other than the vacant former factory and parking area, the site has no other advertised vacancies.</p>	
<p>Strategic Road Access</p>	<p>The site adjoins North Gate and Gladstone Street, with transit along both roads passing residential dwellings.</p> <p>A primary school is located along North Gate; the road has a fixed speed limit of 20mph with several zebra crossing.</p> <p>The B682 is approximately 0.38km to the east, this adjoins the A6514 1.32km to the north.</p>	<p>Very Poor</p>
<p>Local Road Access</p>	<p>The site adjoins North Gate and Gladstone Street. Both roads traverse through residential areas, with North Gate passing a local primary/nursery school. North Gate has a fixed speed limit of 20mph with several zebra crossings.</p>	<p>Very Poor</p>
<p>Proximity to Urban Areas and Access to Labour and Services (including public transport / cycling / walking accessibility)</p>	<p>Located within a residential neighbourhood the site is within close proximity to a convenience store and multiple takeaway shops. Pavement infrastructure runs throughout the site allowing accessibility in and around the site and to amenities in the wider area.</p>	<p>Very Good</p>

	<p>Bus stops are located along North Gate with services to the city centre, Bulwell, Nottingham University Main Campus, Bulwell and Basford.</p> <p>Approximatley 0.40km to the south-west of the site is Shipstone Street tram stop. The tram routes from the stop run towards Phoenix Park and Hucknall.</p>	
<p>Compatibility of Adjoining Uses (including amenity impacts experienced by current/future occupiers and neighbouring areas)</p>	<p>The site is located within a residential neighbourhood including Djanogly Northgate Academy to the north.</p> <p>New Basford Industrial Estate (Radford Road/North Gate) is located to the west.</p>	Very Poor
<p>Developmental and Environmental Constraints (e.g. size; topography; site access; roads, lighting, landscaping, mains utilities and communications infrastructure; flood risk; contamination; nature and heritage conservation)</p>	<p>The site gradually inclines heading south along Palm Street, with Palm Street and Duke Street acting as the main spine roads through the site.</p> <p>A review of Flood Maps for Planning (Gov.uk, 2021) and Historic England Listing Map (2021) shows the site is not located within a Flood Zone nor does it contain any listed buildings.</p>	Very Good
<p>Barriers to Delivery and Mitigation (including ownership constraints - if known)</p>	<p>The site is located within a Mineral Safeguarding Area (Local Plan Policy MI1) and Air Quality Management Area (Policy IN2). Several caves are also designated throughout the site.</p>	Average
<p>Market Attractiveness (including appropriateness, vacancy and market activity on site for the type of development proposed)</p>	<p>Despite the run-down nature of many of the units, the site has no formal vacancies advertised.</p>	Average
<p>Strategic Fit with Growth Area Objectives (by target Market Segment)</p>	<p>The following industrial growth sectors are already located within the site;</p> <ul style="list-style-type: none"> • Food & Drink Manufacturing • Creative & Digital • Retail <p>The site is located within the 'Regional Centre' of Nottingham (as identified in the D2N2 Vision 2030 document).</p>	Average
<p>OVERALL SITE RATING</p>	<p>Average / Poor</p>	
<p>Recommendation and Potential Future Uses</p>	<p>Protect for employment uses</p> <p>Amend the site boundary to exclude the residential area and protect the remainder of the site as a major business/industrial estate</p>	

Given the number of businesses in occupation and, overall, the limited number of vacancies the site should be retained as a designated Major Business/Industrial Estate.

However, the former Guy Birkin Lace premises should not be included within the designation. The site itself has permission for residential development and therefore should naturally be excluded from the site.

The site is well established with some of the buildings themselves constructed in 1872, as noted the condition of the buildings and site is generally in a rundown condition and the site would benefit from some regeneration/renovation.

SITE SUMMARY:

The site is located in New Basford, approximately 4.4km to the north-west of Nottingham City Centre. The site – formally named the New Basford Business Area - borders residential neighbourhoods, with New Basford Industrial Estate (Radford Road/North Gate) to the west. New Basford Business area predominately comprises of approximately 79 small industrial workshops set in a mix of period buildings dating from 1872, industrial courts of single storey with garage door entrances built in the early 2000 and several larger industrial units constructed in the late 1990s.

Overall, the buildings and site are in a relatively poor and tired condition with a former factory in the site in a derelict state (c.0.8oha). Given the number of businesses in the site, the limited number of vacancies and longevity of the site as an industrial estate, New Basford Industrial Estate should be protected for employment uses and the site boundary be amended to exclude the residential area and protect the remainder of the site as a Major Business/Industrial Estate.

However, the site would benefit from an element of regeneration/renovation given the condition of the buildings and site. It is also recommended the site boundary be amended to remove the former Guy Birkin Lace premises given its permission for residential development (ref. 14/00712/PFUL3)

New Basford Industrial Estate (Radford Rd/North Gate) (Ref: NCC22)



**GROSS SITE AREA:
9.10 ha**

**ESTIMATED NET DEVELOPABLE AREA:
0 ha**

CRITERIA	COMMENT	RATING
<p>Site Context</p> <ul style="list-style-type: none"> • Location with regards to existing employment areas and other sites • How the site fits into the overall portfolio 	<p>The site is located in New Basford, positioned approximately 4.48km to the north-west of Nottingham city centre. The site borders New Basford Industrial Estate (Mount Street/Duke Street) to the east and Wilkinson Street Tram depot to the west. The site is partly redeveloped with the construction of modern industrial units (Lewis Industrial Park, pictured above) and contains historic buildings – the former Star Brewery.</p> <p>Further to the north-west (approximately 1.45km) is Bar Lane/Basford Road and Bar Lane Industrial Estate.</p>	
<p>Local Plan Designation</p>	<p>The site is designated as a Major Business Park/Industrial Estate (Local Plan Policy EE2) within the Nottingham City Local Plan. Approximately half of the site falls within the Air Quality Management Area (Policy IN2) and a Mineral Safeguarding Area (Local Plan Policy MI1).</p> <p>The site borders the River Leen to the west (Local Plan Policy EN5), the river is also designated as a Local Wildlife Site (Local Plan Policy EN6, site ref. 5/1501) with an open space green corridor following the river (Local Plan Policy EN1).</p> <p>To the immediate east the site neighbours Palm Street Archaeological Constraints Area and a Conservation Area (Star Buildings, Policy HE1).</p>	
<p>Status in SHLAA</p>	<p>N/A</p>	
<p>Planning History</p>	<p>No recent planning history to note; however, just north of</p>	

	<p>the former gasworks, and outside of the employment boundary, is an approved application for the development of “New two storey custody suite building (Class C2A). Comprising 50 cell custody suite with associated accommodation, amenities, and supporting office space; external works including landscaping, car park, and boundary treatments (ref. 19/01480/PFUL3, Granted 20.11.19).</p>	
Current Use and Land Type	<p>The site is broadly divided into three areas: to the south-west of Radford Road is Lewis Industrial Park – comprising of newly constructed industrial units. To the north-east of Radford Road is a generally tired industrial area including Universal Court, a newly constructed packaging building, a concrete plant and former gas works. Across Radford Road is an impressive historic building – the former Star Brewery Building, dated 1900 and presently in use as the Shipstones Business Centre.</p> <p>The occupiers of the site fall within B2, B8 and E uses.</p>	
Occupier Profile (if partly developed, including % of available land and levels of vacancy onsite)	<p>Occupiers of the site include:</p> <p>Lewis Industrial Park -YESSS Electrical, Electric Centre, Capital Hair & Beauty, Screwfix and Storage King – Self Storage</p> <p>Shipstones Business Centre – John Pye Auctions, John Pye Property Serviced Offices and iRubber</p> <p>Universal Court -Nottingham Central Car Paints, Shopmakers Shopfitting & Joinery Manufacturers, Bottomley & Bottomley, Basford Garage, Mercserve Ltd and David Pengally Autocare Ltd.</p> <p>Simply Cartons, CEMEX Readymix (concrete) Nottingham Plant, NSM Nottingham Scarp Metal, GB Hand Car Wash, Jambons Cash and Carry, Reclaim Building Materials, Nottingham Auto Centre.</p>	
Strategic Road Access	<p>The site connects to the A6514, c1.17km to the west passing residential dwellings.</p>	<p>Very Poor</p>
Local Road Access	<p>The site adjoins Wilkson Street and Radford Road. The tram network itself merges with the road network along Wilkson Street heading west along Shiptone Street. In addition, Radford Road traverses past residential dwellings.</p>	<p>Poor</p>
Proximity to Urban Areas and Access to Labour and Services (including public transport / cycling / walking accessibility)	<p>Located near residential neighbourhoods the site is within close proximity to convenience stores and multiple takeaway shops. Pavement infrastructure ensures connectivity of the amenities in the surrounding area.</p>	<p>Very Good</p>

	<p>Bus stops are located on Radford Road providing services to Basford, Bulwell, the City Hospital and the city centre. The site is immediately adjacent Wilkinson Street tram stop and Shipstone Street tram stop with trams towards Hucknall and Phoenix Park. Wilkinson Street has a park and ride facility inclusive of EV charging points.</p>	
<p>Compatibility of Adjoining Uses (including amenity impacts experienced by current/future occupiers and neighbouring areas)</p>	<p>The site neighbours residential areas to the north and the south, with Radford Road Police Station also located to the immediate south. NSM scrap metal itself faces a row of residential dwellings.</p> <p>To the east is New Basford Industrial Estate (Mount Street/Duke Street) and Wilkinson Street Tram depot to the west.</p>	Very Poor
<p>Developmental and Environmental Constraints (e.g. size; topography; site access; roads, lighting, landscaping, mains utilities and communications infrastructure; flood risk; contamination; nature and heritage conservation)</p>	<p>The site is an irregular shape, divided by Radford Road through the estates centre. From the road, the site is generally on two levels, declining to the east and inclining to the west.</p> <p>A review of Flood Maps for Planning (Gov.uk, 2021) shows the western area of the site falls within a Flood Zone 3 with some corridors of Flood Zone 2.</p> <p>The site does not contain any listed or locally listed buildings (Historic England Listing Map, 2021; Nottingham City Local and National List, 2021).</p>	Poor
<p>Barriers to Delivery and Mitigation (including ownership constraints - if known)</p>	<p>Approximately half of the site falls within the Air Quality Management Area (Policy IN2), a Mineral Safeguarding Area (Local Plan Policy MI1) and Flood Zone 3.</p>	Very Poor
<p>Market Attractiveness (including appropriateness, vacancy and market activity on site for the type of development proposed)</p>	<p>The site has no vacancies or signs of marketing activity.</p> <p>The former gasworks to the north-east of the site has potential for development and expansion of the site.</p> <p>Whilst a number of uses on the site may be considered 'bad neighbour' there is nevertheless a role for such uses in this location.</p>	Average
<p>Strategic Fit with Growth Area Objectives (by target Market Segment)</p>	<p>The following industrial growth sectors are already located within the site;</p> <ul style="list-style-type: none"> • Construction • Retail 	Poor

	The site is located within the 'Regional Centre' of Nottingham (as identified in the D2N2 Vision 2030 document).	
OVERALL SITE RATING	Average / Poor	
Recommendation and Potential Future Uses	<p>Protect for employment uses</p> <p>Retain current Local Plan designation as a major business/industrial estate</p> <p>The site contains several established businesses including the former Star Brewery, in use as the Shipstones Business Centre. In addition, the site has benefited from recent development with the construction of modern industrial units at Lewis Industrial Park. The site also compliments New Basford Industrial Estate (Mount Street/Duke Street) to the east.</p> <p>There remains an opportunity to redevelop some of the existing buildings in the vicinity of the site and improve the amenity of the area.</p>	
SITE SUMMARY:		
<p>The site is located in New Basford, positioned approximately 4.48km to the north-west of Nottingham city centre. The site borders New Basford Industrial Estate (Mount Street/Duke Street) to the east and Wilkinson Street Tram depot to the west. The site is generally divided into three areas, to the south-west of Radford Road is Lewis Industrial Park – comprising of newly constructed industrial units. To the north-east of Radford Road is a generally tired industrial area including Universal Court, a newly constructed packaging building, a concrete plant and former gas works. Across Radford Road is an impressive historic building – the former Star Brewery Building, dated 1900 and currently in use as the Shipstones Business Centre.</p> <p>Given the site's proximity to New Basford Industrial Estate (Mount Street/Duke Street) and the recent development of new industrial unit at Lewis Industrial Park, the site should be protected for employment uses and retain its allocation as a Major Business/Industrial Estate - although it would benefit from further amenity improvements and redevelopment of some of the poorer quality industrial buildings.</p>		

NG2 Business Park (Ref: NCC23)



GROSS SITE AREA:
15.71 ha

ESTIMATED NET DEVELOPABLE AREA:
2.72 ha

CRITERIA	COMMENT	RATING
<p>Site Context</p> <ul style="list-style-type: none"> • Location with regards to existing employment areas and other sites • How the site fits into the overall portfolio 	<p>The site is located to the south-west of Nottingham city centre, approximately 2.3km from the cities train station.</p> <p>Beyond the bordering railway line to the north is Castle Marina Retail Park, with Queens Drive Industrial Estate and the Canal Quarter further to the north-west. To the south-west and beyond the River Leen, the site neighbours the Riverside/Lenton Lane industrial area, incorporating Boots HQ. The site is also in close proximity to the University of Nottingham King’s Meadow Campus.</p>	
<p>Local Plan Designation</p>	<p>The site is allocated within the Nottingham City Local Plan as a Major Business Park / Industrial Estate (Local Plan Policy EE2). The east and western quarters of the site are also allocated as development sites (Local Plan Policy SA1, site references SR41 and SR42). The Local Plan Part 2 has identified these sites for the construction of approximately 13,000-15,000 sqm and 10,000-12,000 sqm of office space respectively.</p> <p>Other designations include;</p> <ul style="list-style-type: none"> • Air Quality Management Area (Policy IN2) • Mineral Safeguarding Area (Local Plan Policy MI1) • Proposed Cycle Route Improvements (Local Plan Policy TR3) <p>The site immediately abuts two Local Wildlife Sites to the north and west (Policy EN6, King’s Meadow Grassland and Lenton Triangle). These areas are also allocated as part of the Open Space Network (Local Plan Policy EN1).</p>	

Status in SHLAA	N/A
Planning History	<p>Recent planning history;</p> <ul style="list-style-type: none"> • 16/00526/POUT - Development of offices (Use Class B1a), restaurant/cafe (Use Class A3), or hotel (Use Class C1) or Car Showroom (Sui Generis), including landscaping, service yards, car parking and vehicular/pedestrian access – Granted - 05.08.16 • 16/02615/PRES4 - Car dealership and associated works. Approval of reserved matters (layout, scale, appearance and landscaping) for outline planning permission reference 16/00526/POUT – Granted – 16.02.17 • 18/00920/PVAR3 - Car dealership and associated works. Approval of reserved matters (layout, scale, appearance and landscaping) for outline planning permission reference 16/00526/POUT (Variation of conditions S1 of planning permission reference: 16/02615/PRES4 to enable alterations to footprint of showroom and external layout of site) – Granted – 10.10.18
Current Use and Land Type	<p>Modern office facilities with national and global businesses in occupation. The buildings range in height from 3-4 storeys, built of modern brick (of sand colour) with considerable glass frontages and have ancillary parking facilities.</p> <p>To the north, outwith the site boundary is a Mercedes Benz and Jaguar Land Rover sales garage.</p> <p>Occupiers of the site fall within use class E.</p>
Occupier Profile (if partly developed, including % of available land and levels of vacancy onsite)	<p>Occupiers of the site include:</p> <p>Geldards LLP Law Firm RWM Ryley Wealth Management The Co-Operative (offices) Pendland Brands (sports clothing company) – offices include Speedo, Canterbury and Mitre Russell Ulyatt (financial services) Global Fire Systems Limited L&H Homes JRT Insurance Innes England (Real Estate Agents) The Castle View Clinic Staffline East Midlands Chamber of Commerce (Derbyshire, Nottinghamshire, Leicestershire) D2N2 (Derby, Derbyshire, Nottingham and Nottinghamshire) VF Northern Europe – Timberland, Vans, Altra, Napapijri, Kipling, Live.Light, Eastpak U.S.A, Icebreaker, Smartwool, The North Face and Dickies. Specsavers</p>

	<p>FortuneFish ITV Central Redscan (cyber security services) Experian (corporate office)</p> <p>Within the north-corner of the site an area of land currently used for car parking adjacent potential development land. Collectively, this area measures approximately 1.62ha. A second parcel of vacant land is available to the south-east of the site at c.1.1ha.</p> <p>The site has two office vacancies;</p> <ul style="list-style-type: none"> • No 14, The Triangle Enterprise Way – 1,022 sp. ft. – 2,047 sq. ft. (to let) • No 21 (Unit 4.2), The Triangle Enterprise Way – 2,800 sq. ft. 	
Strategic Road Access	The site directly adjoins Queens Drive (A452) via a traffic light junction.	Average
Local Road Access	The site adjoins Queens Drive via Enterprise Way, the road is shared with the tram network.	Very Good
Proximity to Urban Areas and Access to Labour and Services (including public transport / cycling / walking accessibility)	<p>To the north of the site is Castle Marina Retail Park. The park has multiple retail and hospitality premises such as a McDonalds, Costa Coffee, Pizza Hut, Sainsbury's and Lidl supermarket. The park is easily accessed by good pedestrian infrastructure, an approximate 6-minute walk). The site is also walkable to the city centre, 2.21km to the north-east.</p> <p>The site benefits from shared pedestrian and cycleways. Cycle paths adjoin the site and connect to QMC, Lenton, University Park, Beeston and the city centre.</p> <p>NG2 has its own tram stop located on Enterprise Way. The trams connect the site to Toton Lane and Hucknall.</p>	Very Good
Compatibility of Adjoining Uses (including amenity impacts experienced by current/future occupiers and neighbouring areas)	<p>The site immediately abuts two Local Wildlife Sites to the north and west (Policy EN6, King's Meadow Grassland and Lenton Triangle). These areas are also allocated as part of the Open Space Network (Local Plan Policy EN1).</p> <p>Queens Drive Industrial Estate lies to the south.</p>	Good
Developmental and Environmental Constraints (e.g. size; topography; site access; roads, lighting, landscaping, mains utilities and communications infrastructure; flood risk;	<p>The site has a single ingress and egress via Enterprise Way which directly adjoins Queens Drive via a traffic light junction. Enterprise Way is also shared with the tram network.</p> <p>A review of Flood Maps for Planning (Gov.uk,</p>	Good

contamination; nature and heritage conservation)	<p>2021) shows the site is located within a Flood Zone 2. The River Leen to the south benefits from flood defences.</p> <p>There are no listed buildings within the site (Historic England Listing Map (2021).</p>	
<p>Barriers to Delivery and Mitigation (including ownership constraints - if known)</p>	<p>The site is underlain by a principal aquifer and it should be ensured that development does not result in pollution of the groundwater resource.</p> <p>Any planning application within the site must be accompanied by a site-specific flood risk assessment that should consider flooding from the River Leen and overtopping and breach of the River Trent flood defences.</p> <p>The site is also located within an Air Quality Management Area (Policy IN2) and Mineral Safeguarding Area (Local Plan Policy MI1). Prior notification is required for development in the mineral safeguarding area but is not considered a barrier to development (Local Plan Part 2).</p>	Average
<p>Market Attractiveness (including appropriateness, vacancy and market activity on site for the type of development proposed)</p>	<p>The site has two office vacancies:</p> <ul style="list-style-type: none"> • No 14, The Triangle Enterprise Way – 1,022 sp. ft. – 2,047 sq. ft. (to let, £36,500 p. a.) (Innes England) • No 21 (Unit 4.2), The Triangle Enterprise Way – 2,800 sq. ft. (to let £50,000 p. a.) (David Hammond) <p>No 10. was previously advertised for sale or lease, at a guide price of £475,000 (Savills).</p> <p>The agents describe the buildings as modern premises in one of the most popular business parks in Nottingham.</p>	Very Good
<p>Strategic Fit with Growth Area Objectives (by target Market Segment)</p>	<p>The following industrial growth sectors are already located within the site;</p> <ul style="list-style-type: none"> • Health/Social Care • Professional/Business Service <p>The site is located within the ‘Regional Centre’ of Nottingham (as identified in the D2N2 Vision 2030 document).</p>	Very Good
OVERALL SITE RATING	Very Good	
<p>Recommendation and Potential Future Uses</p>	<p>Allocate for employment uses</p> <p>Retain current Local Plan designation as a major business/industrial estate</p>	

	<p>The site is one of the most popular business parks in Nottingham attracting occupiers such as Experian, The Co-Operative and Pendland Brands Group amongst others.</p>
--	---

	<p>The site designation should be retained.</p>
--	---

SITE SUMMARY:

The site is located to the south-west of Nottingham City Centre and is described as the most popular business park in Nottingham. The site contains modern office accommodation which is occupied by businesses such as Experian, The Co-operative and the Pendland Brands Group amongst others. The site benefits from an immediate tram stop positioned in the centre of the park.

Given the park's popularity and status of occupants the site should be allocated for employment uses and retained as a Major Business/Industrial Estate.

Castle Quarter (Ref: NCC24)

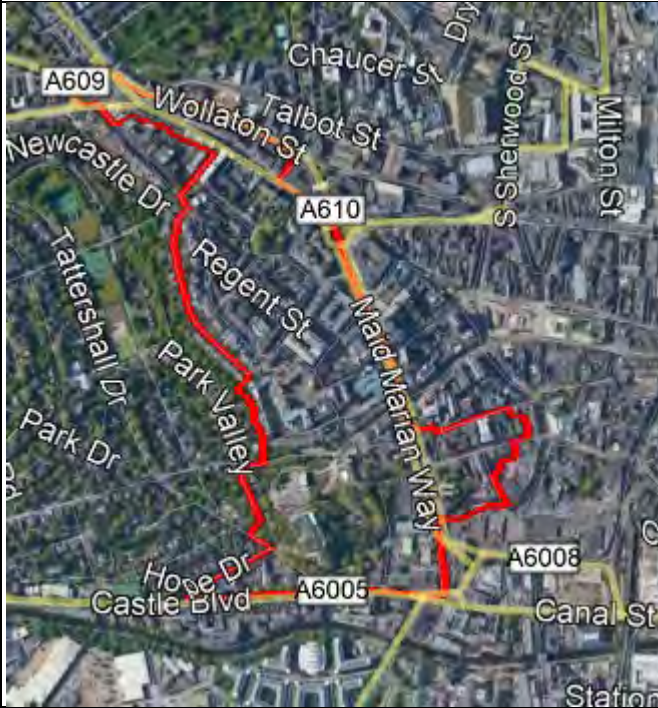

**GROSS SITE AREA:
28.75 ha**

**ESTIMATED NET DEVELOPABLE AREA:
0 ha**

CRITERIA	COMMENT	RATING
<p>Site Context</p> <ul style="list-style-type: none"> • Location with regards to existing employment areas and other sites • How the site fits into the overall portfolio 	<p>This very large site is located within the heart of Nottingham City Centre. Nottingham Castle defines the quarter located on a commanding position atop of Castle Rock. The quarter is historic containing monuments such as Nottingham cathedral and Ye Olde Trip to Jerusalem Public House (Grade II Listed).</p> <p>The site forms part of a highly distinctive city centre quarter that is complimentary to the shopping core of the city. The remaining quarters include the Royal, Creative and Canal quarters. This area in particular has scope to capitalise within the leisure and tourism sector.</p>	
<p>Local Plan Designation</p>	<p>The site is identified as the Castle Quarter within the Nottingham Local Plan (Local Plan Policy RE4). The quarter contains a number of landmark buildings (Local Plan Policy DE2) such as St. Barnabas Cathedral, Albert Hall Tower, Jubilee Wing of General Hospital and Nottingham Castle and walls.</p> <p>The south-eastern corner of the site is also designated as a development site (Local Plan Policy SA1, site ref SR57) for mixed use redevelopment including 75 dwellings and between 5,500-10,000sqm of office floor space.</p> <p>Other designations include;</p> <ul style="list-style-type: none"> • Archaeological Constraints Area (Policy HE1) • Proposed Cycle Route Improvements (Local Plan Policy TR3) • Multiple Cave allocations (Local Plan Policy HE2) • Mineral Safeguarding Area (Local Plan Policy MI1) 	

	<ul style="list-style-type: none"> • Air Quality Management Area (Policy IN2) • Within several Conservation Areas (Policy HE1, Wellington Circus, Castle and Canning Circus) • Nottingham Castle Rock, designated as a Local Geological Site (Policy EN6) and part of the Open Space Network (Local Plan Policy EN1). A second Local Geological Site is also designated within the northern area of the site (Tunnel Road) • Derby Road, designated as a corridor of Independent Retail Clusters (Local Plan Policy SH5).
Status in SHLAA	Site ID: 459, Maid Marian Way – College Site for 75 dwellings.
Planning History	<p>Recent planning history includes;</p> <ul style="list-style-type: none"> • 19/01957/PFUL3 - Change of Use from Hotel (C1) to 12 x flats (C3) involving external amendments to the existing elevation, the construction of a new dormer window on the second floor, insertion of roof lights and internal alterations consisting of a new structural floor, new walls and demolition of some existing walls and staircases – Granted – 09.10.20 • 19/01081/PFUL3 - Change of use of restaurant to 9 residential apartments including the construction of a 3-storey extension to the rear of the building – Granted – 12.11.19 • 18/02112/PVAR3 - Variation of Condition S1 (elevation and plan amendments) of planning permission reference 17/01999/PFUL3 – Granted – 16.05.19 • 17/01999/PFUL3 - Demolition of former restaurant building. Construction of a 5-storey building comprising a retail ground floor use (Class A1) with student accommodation above in a mix of studios and cluster flats – Granted – 25.04.18 • 17/01882/PFUL3 - Conversion from office to 11 apartments, including associated internal and external alterations – Granted – 04.12.17 • 16/02868/PVAR3 - Proposed two storey rooftop extension to form 33 self-contained residential studios, including works to the external appearance of the existing building. (Variation to condition S1 (Plans) and condition 2 (sections and materials) of planning application 15/02962/PFUL3 to enable alterations to the style of windows proposed to the rear elevation and remove the requirement to re-clad the front and sides of the building.) – Refused – 20.03.17 • 16/02734/PVAR3 - Conversion and extension to create student accommodation (Variation of condition S1 of planning permission reference 15/01593/PFUL3 to enable 10 additional studio rooms) – Granted – 31.03.17
Current Use and Land Type	A mixed-use city centre site containing residential dwellings, student accommodation, shops, museums, offices, hospitality venues and theatre. The site also benefits from multiple

	<p>private healthcare clinics (including dentists, counsellors and psychotherapists) along Regent Street.</p> <p>The sites obvious assets are the quarters historic monuments such as Nottingham Castle, Ye Olde Trip to Jerusalem Public House, Nottingham Playhouse and multiple grade listed buildings along Park Terrace. The site has good levels of parking availability with multiple NCP car parks.</p> <p>In summary the premises within the site fall within class C3, E, F1(a), F1(f) and Sui generis uses.</p>
<p>Occupier Profile (if partly developed, including % of available land and levels of vacancy onsite)</p>	<p>Occupiers of the site include: Nottingham College Maid Marian Way, London Boots, Gooii Ltd (websites and apps), Castle Gym, Dynamic Yoga, Brewhouse Yard Museum, Castle Heights Nottingham (Office Space), Ludorati Café Bar, Cumin Indian Restaurant, Kaspas Deserts, iQ Student Accommodation (Newton House, c.10 storey student accommodation), Pure Electric Bikes, Britannia Hotel, Tesco Express Evans Cycles, Citizen Advice Nottingham, Calcutta Club (Indian restaurant), Grosvenor Casino, KPMG, Foresight Group, UHY Hacker Young Chartered Accountants, Hollis, Roythornes Solicitors Nottingham Cathedral, St. Joseph’s Independent Nursery School Tough Mary’s Bakehouse, Comfort Lettings, Windblowers (music shop), Cartwright Communications – PR, Marketing and Digital Media, Ropewalk Chambers (Multidisciplinary barristers’) Swan Homes, Kingswood Residential Investment Management Inside Land Group, Survey Hub, Nottingham Park Clinic Tate (Counsellor & Psychotherapist), Seagrave French (Business advisers and accountants), Elevation (Investment Management) St James Hotel, Nottingham Castle, Castle Takeaway and Central Police Station.</p> <p>The site contains several vacant units:</p> <ul style="list-style-type: none"> • Castle Heights first floor office accommodation (2,453 sq. ft.) • Storefront to Rent below Britannia Hotel (16,780 sq. ft.) • M.Kemp, former antiques shop (1,721 sq. ft) • Chartwell House, self-contained offices with onsite parking (5,805 sq. ft.) • Hine House, three refurbished office suites in landmark building on Regent Street (193 sq. ft. – 376 sq. ft.) • First and Second Floor Offices above a leisure space set to become a champagne bar (668 sq. ft.)
<p>Strategic Road Access</p>	<p>Average</p>

	<p>The site adjoins Queens Drive (A453) to the south and Derby Road (A6200) to the north.</p> <p>Maid Marian Way (A6008) acts as a through road across the site.</p>	
Local Road Access	<p>Accessible via Maid Marian Way although congestion at peak times.</p>	Average
Proximity to Urban Areas and Access to Labour and Services (including public transport / cycling / walking accessibility)	<p>This city centre site itself has a wide range of retail and food premises for visitors and office workers alike.</p> <p>Castle Quarter has excellent pedestrian infrastructure and a designated cycle lane runs along Maid Marian Way.</p> <p>The site is well served by public transport with bus services to Wollaton, Park Estates, Lenton, Eastwood, Ripley, Alferton and the city centre. The city train station is approximately 0.71km to the south west, with rail services towards Skegness, Lincoln Central, Worksop, Matlock, Leeds, Cardiff Central, Liverpool Lime Street and London St Pancras.</p> <p>The station also benefits from a designated tram stop with tram routes to Clifton South, Phoenix Park, Hucknall and Toton Lane.</p>	Very Good
Compatibility of Adjoining Uses (including amenity impacts experienced by current/future occupiers and neighbouring areas)	<p>The site is located within the heart of the city centre and forms part of the distinctive city centre quarters.</p>	Average / Good
Developmental and Environmental Constraints (e.g. size; topography; site access; roads, lighting, landscaping, mains utilities and communications infrastructure; flood risk; contamination; nature and heritage conservation)	<p>The site is an irregular shape, with generally rising topography heading north along Maid Marian Way. The roads along Regent Street and towards the Castle are particularly undulating.</p> <p>A review of Flood Maps for Planning (Gov.uk, 2021) shows the wider site is not located within a Flood Zone.</p> <p>The quarter is historic, containing many famous monuments including Nottingham cathedral, Ye Olde Trip to Jerusalem Public House and the castle itself which are Nationally and Locally listed (Historic England Listing Map, 2021; Nottingham City Local and National List, 2021).</p>	Average
Barriers to Delivery and	<p>The site is located within an Air Quality</p>	Poor

<p>Mitigation (including ownership constraints - if known)</p>	<p>Management Area (Policy IN2); Mineral Safeguarding Area (Local Plan Policy MI1); an Archaeological Constraints Area (Policy HE1); and within several Conservation Areas (Policy HE1, Wellington Circus, Castle and Canning Circus).</p> <p>Multiple cave allocations are also designated throughout the site (Local Plan Policy HE2).</p>	
<p>Market Attractiveness (including appropriateness, vacancy and market activity on site for the type of development proposed)</p>	<p>The site has several vacant premises scattered throughout the quarter:</p> <ul style="list-style-type: none"> • Castle Heights first floor office accommodation (2,453 sq. ft., to let) (Geo Hallam & Sons) (£14 per sq. ft.) • Storefront to Rent below Britannia Hotel (16,780 sq. ft., to let) (FHP) (rent upon application, for a 15-year lease) • M.Kemp Antiques (1,721 sq. ft, for sale) (Savills) (£225,000, under offer) • Chartwell House (5,805 sq. ft., for sale) (Savills) (£795,000, under offer) • Hine House, three refurbished office suites in landmark building on Regent Street (193 sq. ft. – 376 sq. ft., to let) (FHP) (£6,750 p.a. – £13,150 p.a.) • First and Second Floor Offices above a leisure space set to become a champagne bar (668 sq. ft., to let) (Lambert Smith Hampton) (£23.95 per sq. ft.) 	<p>Very Good</p>
<p>Strategic Fit with Growth Area Objectives (by target Market Segment)</p>	<p>The following industrial growth sectors are already located within the site:</p> <ul style="list-style-type: none"> • Creative & Digital • Visitor Economy • Retail • Health/Social Care • Professional/Business Service <p>The site is located within the ‘Regional Centre’ of Nottingham (as identified in the D2N2 Vision 2030 document).</p>	<p>Very Good</p>
<p>OVERALL SITE RATING</p>	<p>Good</p>	
<p>Recommendation and Potential Future Uses</p>	<p>Protect the site for employment uses/mixed-use (i.e. retain current Local Plan designation as the Castle Quarter)</p> <p>The site should continue to plan for tourism, cultural and leisure development that complements and strengthens the significant heritage assets within the quarter. The site has high-quality office accommodation and this should continue to be provided for in the appropriate locations.</p>	
<p>SITE SUMMARY:</p>		
<p>The site is located within the heart of the city centre. Nottingham Castle defines the quarter located on a commanding position atop of Castle Rock. The site forms part of a distinctive city</p>		

centre quarter including monuments such as Nottingham cathedral and Ye Olde Trip to Jerusalem Public House which are complimentary to the shopping core of the city. The historical features of the site are its most obvious assets, but the site also contains a mix of premises including residential sites, student accommodation, shops, museums, offices, hospitality venues and a theatre. The site also benefits from multiple private healthcare clinics (including dentists, counsellors and psychotherapists) along Regent Street.

The site be protected for employment uses/mixed use and should retain its allocation as set out in the Local Plan policy description for the Castle Quarter. The site should also continue to plan for tourism, cultural and leisure development that complements and strengthens the existing heritage offer within the quarter. High-quality office accommodation should also continue to be provided for in appropriate locations.

Creative Quarter (Ref: NCC25)



**GROSS SITE AREA:
59.11 ha**

**ESTIMATED NET DEVELOPABLE AREA:
0.094 ha
(ref. 18/00565/POUT)**

CRITERIA	COMMENT	RATING
<p>Site Context</p> <ul style="list-style-type: none"> • Location with regards to existing employment areas and other sites • How the site fits into the overall portfolio 	<p>The site is located within the heart of the city centre, with the quarter itself containing prominent sites such as Lace Market, Motorpoint Arena, Sneinton Market and the National Ice Centre.</p> <p>The site forms part of a distinctive city centre quarter that is complimentary to the shopping core of the city. The remaining quarters include the Royal, Castle and Canal Quarter. Additional development is also expected to the south-east of the site within the Canal Quarter with the regeneration of the 'Island Site'.</p>	
<p>Local Plan Designation</p>	<p>The site is allocated as the Creative Quarter within the Nottingham Local Plan (Local Plan Policy RE3). The site also contains a number of landmark buildings (Local Plan Policy DE2) including St Marys Church, Lace Hall, Lace Market cliff face and buildings and buildings south of Lace Market Theatre.</p> <p>Three development sites are allocated within the western boundary of the site (Local Plan Policy SA1). These include Brook Street East (site ref SR54) for 43 dwellings; Sneinton Market (SR55) for a mixed-use scheme of 100-120 dwellings, small scale office and retail facilities with leisure and community uses; and Bus Depot (SR56) for a second mixed use development of 100-170 dwellings, 5,000 sqm of office floorspace (maximum estimate), small scale retail, leisure and conference/convention centre.</p> <p>Other designations include:</p>	

	<ul style="list-style-type: none"> • Several patches apart of the Open Space Network (Local Plan Policy EN1) • Proposed Cycle Route Improvements (Local Plan Policy TR3) • Mineral Safeguarding Area (Local Plan Policy MI1) • Lace Market Conservation Area within the north-east of the site (Policy HE1) and Sneinton Market Conservation Area within the west of the Creative Quarter boundaries. • Archaeological Constraints Area (Policy HE1) • Air Quality Management Area (Policy IN2) • Multiple cave allocations (Local Plan Policy HE2) • To the north-east of the site, a cluster of Independent Retail (Local Plan Policy SH5, Carlton Street) are designated, these are also allocated as a Primary Shopping Frontage (Goosegate, Carlton Street) and form part of the Primary Shopping Area (Local Plan Policies, SH2, SH3, SH8, DE4 and LS1).
Status in SHLAA	<p>Site ID: 541 Creative Quarter – Sneinton Market – for 167 dwellings Site ID: 540 Creative Quarter – Bus Depot – for 135 dwellings</p>
Planning History	<p>Recent planning history includes:</p> <ul style="list-style-type: none"> • 19/02061/PFUL3 - Extension and alteration to create 11 additional apartments – Granted – 25.10.19 • 19/00661/PVAR3 - Residential development of 85 apartments including communal facilities, basement parking and a commercial unit. Variation of condition S1 of planning permission reference 16/01352/PFUL3 (Changes to the external appearance and internal layout of development and increasing number of units to 90) – Granted – 02.12.19 • 18/02624/PFUL3 - Demolition of existing buildings and erection of student accommodation development (5 - 6 storeys) with cafe bar and exhibition space (Use Classes A3/A4/D2) - Granted – 14.05.19 • 18/02061/PVAR3 - Conversion of building to create 10 self-contained flats (Variation of Condition S1 (Plans) to enable alterations to plans approved under application reference 15/03127/PFUL3 involving exposing and reinstating the existing stairwell to the rear of the property, provision of 1 flat within the basement, provision of two flats on ground, first and third floors, and three flats on second floor, with further changes proposed to the internal layout of these upper floor flats) – Granted – 15.10.19 • 18/01118/PVAR3 - 117 apartments with basement car park, comprising change of use of rear of 9 Short Hill (plus additional floor to roof), change of use of 54-56 High Pavement, a new 5-storey building to Short Hill, a new 3/5/7-storey building to Malin Hill, demolition

	<p>of 10 Short Hill (facade retained) and demolition of extensions at rear of 56 High Pavement (variation of conditions S1 of 16/02249/PFUL3 to enable the demolition and rebuild of the eastern wall of 10 Short Hill, and to enable relocation of storage facilities) – Granted – 28.11.18</p> <ul style="list-style-type: none"> • 18/00565/POUT - Outline planning application for the erection of up to 42 flats or 91 student beds within a seven-storey development of up to a total of c. 585.3 square metres, including details of access, layout and scale – Granted – 27.02.19 • 17/02557/PFUL3 (for Site ID: 541) - Refurbishment and partial demolition of existing buildings with erection of new three storey building with accommodation within roofspace creating 44 new apartments (including 36 student apartments) with A1 and A3 uses at ground level – Granted – 02.08.18 • 17/02664/PFUL3 - Development of Educational Hub (College) and associated works for Nottingham College – Granted – 26.02.18 • 17/01992/PFUL3 - Erection of student accommodation – Granted – 07.09.18 • 17/00751/POUT - Outline planning application for the development of up to 43 houses, apartments and duplexes with shared facilities and external courtyards, including details of access, layout and scale – Granted – 30.11.18 • 16/02249/PFUL3 - 117 apartments with basement car park, comprising change of use of rear of 9 Short Hill (plus additional floor to roof), change of use of 54-56 High Pavement, a new 5-storey building to Short Hill, a new 3/5/7-storey building to Malin Hill, demolition of 10 Short Hill (facade retained) and demolition of extensions at rear of 56 High Pavement – Granted – 25.05.18 • 16/01352/PFUL3 - Residential development of 85 apartments including communal facilities, basement parking and a commercial unit – Granted – 26.03.19
<p>Current Use and Land Type</p>	<p>A mixed-use city centre site containing residential dwellings, serviced apartments, student accommodation, shops, offices, hospitality venues, notable entertainment premises and Lace Market. The Market itself features restaurants and cafes on the ground floors of the historic buildings with office accommodation above.</p> <p>In summary the buildings within the site fall within class B8, C3, E, F1(b), F1(f), F2(a), F2(d) and Sui Generis uses.</p>
<p>Occupier Profile (if partly developed, including % of available land and levels of vacancy onsite)</p>	<p>Occupiers of the site include: Nottingham College, Lace Market Embroidery, Oscar and Rosie’s Pizza, Bistro Live, Professional Music Technology, Shell petrol station, The Salvation Army, Metronome</p>

	<p>Student Accommodation, Safestyle UK Replacement Window Centre NG One - Vintage Clothes, Royal Mail Nottingham City Delivery Office, Safe Store Self storage, Nonsuch Studios – Performance, events, space hire, Saracens Restaurant, Nottingham Arena Car Park (Brook Street), iQ student accommodation, Subway Murat Food Centre. Sneinton Market, Motorpoint arena, National Ice Centre, Nottingham City Transport Depot and Nottingham City Transport Head office (building dated 1926) Machine Mart, Biocity, Stoney Street Studios – flexible office space, The Lacehouse (restaurant), Art Gallery, Lace Market Car Park, NCP Car Park Stoney Street, Lace Market Hotel and Stoney Street Studio Offices.</p> <p>Several premises are available within the site:</p> <ul style="list-style-type: none"> • Land used as a car park (0.094ha) on Cowan Street for sale as residential/student accommodation land (Harris Lamb). The site has planning permission for up to 42 flats or 91 student bed within a seven-storey development (ref. 18/00565/POUT). • Second Floor Office Suite, 39 Stoney Street (2,669 sq. ft.) • 48/50 St. Marys Gate, offices for sale (4,081 sq. ft.) • Restaurant-Bar Unit 2-4 Adams Walk to let. Offers invited. 	
Strategic Road Access	The site is accessed via the A60 which forms the main trunk road through the site.	Average
Local Road Access	Accessible from the A60, although congestion at peak times.	Good
Proximity to Urban Areas and Access to Labour and Services (including public transport / cycling / walking accessibility)	<p>Located within the city centre, the site has a wide range of retail and food premises for consumers.</p> <p>As a city centre site, the quarter has very good pedestrian infrastructure with multiple bus stops throughout providing services to Carlton, Bakersfield, Gedling, Mapperley and Southwell.</p> <p>Lace Market tram stop is also positioned at the north-west edge of the site with trams towards Clifton South, Phoenix Park, Hucknall and Toton Lane.</p>	Very Good
Compatibility of Adjoining Uses (including amenity impacts experienced by current/future occupiers and neighbouring areas)	The site is located within the heart of the city centre and forms part of the distinctive city centre quarters.	Average / Good

<p>Developmental and Environmental Constraints (e.g. size; topography; site access; roads, lighting, landscaping, mains utilities and communications infrastructure; flood risk; contamination; nature and heritage conservation)</p>	<p>The site is irregular in shape with the A60 acting as a through road.</p> <p>A review of Flood Maps for Planning (Gov.uk, 2021) shows the majority of the site is not located within a Flood Zone. However, Canal street, that runs along the southern border of the site is designated within a Flood Zone 3/Flood Zone 3 but is an area benefiting from flood defences.</p> <p>The site has a list of buildings that are both grade and locally listed (Historic England Listing Map, 2021; Nottingham City Local and National List, 2021).</p>	<p>Average</p>
<p>Barriers to Delivery and Mitigation (including ownership constraints - if known)</p>	<p>The site is located within a Mineral Safeguarding Area (Local Plan Policy MI1); Air Quality Management Area (Policy IN2); Archaeological Constraints Area (Policy HE1); and within several Conservation Areas (Policy HE1, Lace Market within the north-east of the site and Sneinton Market Conservation within the west of the Creative Quarter boundaries).</p> <p>Multiple cave allocations are also designated throughout the site (Local Plan Policy HE2).</p> <p>SITE ID 540 also details the site is part owned by Nottingham City Council and will require relocation of the existing businesses at the site, therefore the sites delivery is anticipated late in the plan (SHLAA, 2020).</p>	<p>Poor</p>
<p>Market Attractiveness (including appropriateness, vacancy and market activity on site for the type of development proposed)</p>	<p>The site has several vacant premises scattered throughout the site:</p> <ul style="list-style-type: none"> • Land used as a car park (0.094ha) on Cowan Street for sale as residential/student accommodation land (Harris Lamb). The site has planning permission for up to 42 flats or 91 student bed within a seven-storey development (ref. 18/00565/POUT). Harris Lamb does not detail the price of the site but notes the S.106 has been signed. • Second Floor Office Suite, 39 Stoney Street (2,669 sq. ft., to let) (FHP) (£42,800 p.a.) • 48/50 St. Marys Gate, offices for sale (4,081 sq. ft.) (Savills) (£795,000) • Restaurant-Bar Unit 2-4 Adams Walk to let. Offers invited (Everard Cole) <p>Savills describe Lace Market as being an unrivalled city centre location, categorised by a mixture of attractive period residential and</p>	<p>Very Good</p>

	commercial properties that have undergone significant gentrification.	
Strategic Fit with Growth Area Objectives (by target Market Segment)	<p>The following industrial growth sectors are already located within the site;</p> <ul style="list-style-type: none"> • Life Sciences • Creative & Digital • Visitor & E-Commerce • Logistics & E-commerce • Retail • Professional/Business Service <p>The site is located within the 'Regional Centre' of Nottingham (as identified in the D2N2 Vision 2030 document).</p>	Very Good
OVERALL SITE RATING	Good	
Recommendation and Potential Future Uses	<p>Protect the site for employment uses/mixed-use (i.e. retain current Local Plan designation as the Creative Quarter)</p> <p>The site should continue to provide a range of workspaces that are supportive of the creative industry such as workshops, studios and some offices. Given the presence of Nottingham College, there is potentially scope to plan for educational facilities that train and support the creative industry. This could also include the provision of incubator spaces that provide these ancillary facilities. The site should therefore continue to plan for mixed use schemes including the provision of student accommodation and residential units.</p> <p>Similarly, with the presence of both the Motorpoint arena and National Ice Centre there should be continued support for the hospitality industry, specifically with focus on provision during the night-time economy so long as it does not undermine or compromise the housing amenity.</p>	
SITE SUMMARY:		
<p>The site is located within the heart of the city centre, with the quarter itself containing prominent sites such as Lace Market, Motorpoint Arena, Sneinton Market and the National Ice Centre. The site forms part of a distinctive city centre quarter that is complimentary to the shopping core of the city. The Creative Quarter contains a mix of premises including residential sites, student accommodation, shops, offices, hospitality and leisure venues.</p> <p>The site also has a very active planning history with pro-active development for additional residential dwellings across the site. Given the above characteristics and the site fulfilling a number of the industrial growth sectors targeted by D2N2, the site should be protected for employment uses/mixed-use and retain its allocation as the Creative Quarter.</p> <p>The allocation should provide a range of creative workspaces such as studios and workshops to support the creative industry. This could also be complemented by additional creative educational facilities that train and support creative individuals/businesses.</p>		

Canal Quarter (Ref: NCC26)



**GROSS SITE AREA:
68.54 ha**

**ESTIMATED NET DEVELOPABLE
AREA:
0 ha**

CRITERIA	COMMENT	RATING
<p>Site Context</p> <ul style="list-style-type: none"> • Location with regards to existing employment areas and other sites • How the site fits into the overall portfolio 	<p>The Canal Quarter is within the heart of the city centre, spanning east to west across the city. The bordering quarters include the Castle Quarter to the north and the Creative and Island Quarters to the north-west. To the south-east of the site is Queens Drive and NG2 Business Park.</p> <p>The Canal Quarter has several distinctive sites including the City's main Railway Station (pictured above), numerous solicitor and law firms, HM Revenue and Customs, Nottingham Justice Centre and of course the canal itself.</p>	
<p>Local Plan Designation</p>	<p>The site is designated as the Canal Quarter with the Nottingham Local Plan (Local Plan Policy RE2).</p> <p>The station within the is allocated for rail line upgrading/electrification (Local Plan Policy TR2).</p> <p>A number of development sites are located throughout the site (Local Plan Policy SA1), these include;</p> <ul style="list-style-type: none"> • SR60 (mixed-use development comprising of 319 dwellings, 9000sqm of office floorspace and small-scale retail) • SR61 (mixed use development comprising of 150-200 dwellings, 5000sqm of office floorspace, small scale retail) • SR62 (mixed use development comprising of residential, hotel, assembly and leisure, office (21,000sqm), and small-scale retail. • SR63 (mixed use development of 170 dwellings, office 	

	<p>floorspace (9100sqm) and small-scale retail.</p> <ul style="list-style-type: none"> • SR64 (mixed use development of 305 dwellings, office floorspace (7000sqm) and small-scale retail. • SR65 (mixed use development of 100-140 dwellings, 10,000sqm of office floorspace and small-scale retail) • SR66 (mixed use development of 350 dwellings and small-scale retail. <p>Other designations include;</p> <ul style="list-style-type: none"> • Air Quality Management Area (Policy IN2) • Mineral Safeguarding Area (Local Plan Policy MI1) • Several patches forming part of the Open Space Network (Local Plan Policy EN1) • Multiple cave allocations (Local Plan Policy HE2) • Station Conservation Area and Nottingham Canal Conservation Area (Policy HE1) • Archaeological Constraints Area (Policy HE1, City Centre and Nottingham Canal) • A number of landmark buildings (Local Plan Policy DE2) such as Inland Revenue, British Waterways and Midland Station • Proposed Cycle Route Improvements (Local Plan Policy TR3) • Nottingham Canal flows through the site (Local Plan Policy EN5). The canal is also designated as a Local Wildlife Site (Policy EN6).
<p>Status in SHLAA</p>	<p>Site ID: 347 Canal Quarter – Crocus Street Southpoint for 150 dwellings - (18/02107/PFUL3) Site ID: 524 Canal Quarter – Sheriffs Way/Arkwright Street – for 382 dwellings – (18/00131/PFUL3) Site ID: 525 Canal Quarter – Queens Road, East of Nottingham Station, Queens Road – for 600 dwellings Site ID: 526 Canal Quarter – Station Street/Carrington Street – 319 dwellings - (18/00926/PFUL3) Site ID: 527 Canal Quarter – Waterway Street, Traffic Street – for 567 dwellings – (18/00819/PFUL3) Site ID: 529 Canal Quarter – Arkwright Street East – for 330 dwellings</p>
<p>Planning History</p>	<p>Recent planning history includes;</p> <ul style="list-style-type: none"> • 20/00592/PFUL3 - Demolition of existing office building, erection of two part 3, part 5 and part 6 storey buildings comprising of student accommodation along with associated access, ancillary communal facilities and flexible cafe /event space (use class A3) – Granted – 02.10.20 • 19/01642/PFUL3 - Development comprises the demolition of existing buildings on the site and the construction of studios, one, two and three bedroom apartments (build to rent) with ancillary residential facilities, car and cycle parking, public realm improvements and a mixed use commercial unit on the ground floor (A1, A3, D1, D2) – Granted – 26.04.20

	<ul style="list-style-type: none"> • 19/00936/PFUL3 - Erection of nine and six storey building to provide 39 no. apartments (C3) and 2 no. ancillary commercial units (A3 and / or B1); formulation of new dropped kerb vehicular access from Queens Road for servicing area; and, associated hard and soft landscaping works – Granted – 25.09.20 • 19/00659/NFUL3 - Construction of new build 7 storey commercial office accommodation with associated external works – Granted – 29.08.19 • 18/02596/PVAR3 - 62 new apartments and associated works (Variation of condition S1 (design and appearance) of planning permission reference 15/03198/PFUL3 for 62 apartments) – Granted – 28.03.19 • 18/02277/POUT - Hybrid application for office development (Use Class B1) comprising two buildings totalling up to 58,360 sqm (GIA) together with access and public realm improvements. Phase 1 building (full application) of 36,519 sqm (GIA) and phase 2 building (outline application with access, layout and scale to be considered at this stage) of 21,841 sqm (GIA) – Granted – 16.01.19 • 18/02107/PFUL3 - The development of up to 150 apartments with associated communal space and parking – Granted – 11.06.19 • 18/00926/PFUL3 - Erection of part 6, part 8 and part 9 (plus lower ground floor) storey student accommodation (319 units), provision of ancillary coffee shop, refurbishment and use of former railway arches as space for street traders (Class A1, A3 and A5 uses), landscaping and improvements to the public realm – Granted – 30.08.18 • 18/00916/PFUL3 - Demolition of existing buildings. Proposed five-storey office building with associated undercroft parking, external works, and roof plant area – Granted – 28.09.18 • 18/00819/PFUL3 - Demolition of existing buildings and erection of a part 5, part 6, part 10 and part 12 storey building comprising 118 student apartments along with associated access, communal space, landscaping, cycle parking and two Class A1 retail units – Granted – 14.11.18 • 18/00131/PFUL3 - Mixed residential development of student accommodation (420 beds) and apartments (149 units), and associated works – Granted – 19.06.19
<p>Current Use and Land Type</p>	<p>A mixed-use city centre site, with the Canal Quarter boasting historic buildings such as the train station and canal side properties including the British Waterways building. The site has a number of legal firms in addition to Nottingham Justice Centre itself.</p> <p>In summary, the businesses within the site fall within class C1, C3, E, F1(b), F1(g), F1(e) and Sui Generis Uses</p>

<p>Occupier Profile (if partly developed, including % of available land and levels of vacancy onsite)</p>	<p>Occupiers of the site include: Brownejacobson (private and public sector legal experts), HM Revenue & Customs, Cartwright King Solicitors Willmott Dixon (construction and property services) Nottinghamshire Archives, The Navigation Pub Irish Centre Bar, Grace Church Nottingham, GTT (digital communications), UPS Ltd (Capital Insurance Agency), Buzz Group Ltd, GVC (sports betting and gaming entertainment) Castle Veterinary Centre, Little Way Periodontics – Specialist Dental Practice, Kevin Manners Denture Clinic, Parexcel (Clinical research), The Waterfront (bar and restaurant), HM Land Registry Fit Space, Via Fossa (bar and restaurant), Lloyds Bar Canalhouse (bar and restaurant), Fellows Morton and Clayton Limited Pub, Café Nero, Sainsbury’s Local, Greggs Carringtons Fish and Chips, Barley Twist (bar) Portland House Student Accommodation 38 Carrington Street, Architecture, Urban Design, Heritage, Community, Sustainability Nottingham Justice Centre, Magistrates Court and Family and Youth Court Bridewell Police Station, Superdrug, Tesco Express, Starbucks Coffee, The Bentinck Hotel, Tribunal Hearing Centre, Nottingham Train Station, Carringtons Solicitors, British Transport Police Centrick (real estate agents), Access Self Storage Private Car Park (unoccupied), Nottingham Station car park United Carpets Woodfloor and beds, Magpie Security Ltd., Nottinghamcar.com, Direct Van Hire, Virgin Active Health Club (in former train station building) Waterfront House Offices – Shoosmiths, Macildowie (recruiters) BWB (building, infrastructure and environmental consultancy) Ikano (bank), Brewin Dolphin (wealth managers), Shakespeare Martineau, Nottingham City Council Building, VITA student accommodation and Hopkinson (antiques and arts centre)</p> <p>The site has several vacancies including:</p> <ul style="list-style-type: none"> • Castle Court 59 Castle Boulevard (self-contained office suites within a Grade II Listed building) (1,934 sq. ft. – 31,909 sq. ft.) • Courtyard 2 Arkwright Street (self-contained office suite) (1,798 sq. ft.) 	
<p>Strategic Road Access</p>	<p>The site is accessible via London Road (A60) to the west, Queens Drive (A453) from the south, and Maid Marian Way (A6008) from the north.</p>	<p>Average</p>
<p>Local Road Access</p>	<p>The A6005 (Castle Boulevard) traverses east to west across the site, although congestion at peak times.</p>	<p>Good</p>

<p>Proximity to Urban Areas and Access to Labour and Services (including public transport / cycling / walking accessibility)</p>	<p>Located within the city centre, the site has a very wide range of retail and food premises for consumers.</p> <p>The Canal Quarter has very good pedestrian infrastructure and a designated cycle lane runs along Castle Boulevard.</p> <p>The site is well serviced by transport with bus services (there is particularly a cluster of stops outside the train station) with regular services to Clifton, Boots, Lady Bay, Silverdale, East Leake, Gotham and Loughborough.</p> <p>The city train station is located within the Canal Quarter providing services to Leicester, Skegness, Norwich, Gloucester, Leeds, Matlock, Worksop, Manchester Piccadilly and London St Pancras International. The station also benefits from the tram stop connecting the site to Hucknall, Toton Lane, Clifton South and Phoenix Park.</p> <p>The station is considered a new transport interchange that forms part of 'The Hub', a separate project to Phase 2 of the NET light rail system (serving the conurbation's south and west as part of the Greater Nottingham Strategy), but complementary of the project to redevelop Nottingham station into a new rail/bus/parking interchange (Railway Technology Projects, 2021).</p>	<p>Very Good</p>
<p>Compatibility of Adjoining Uses (including amenity impacts experienced by current/future occupiers and neighbouring areas)</p>	<p>The site is located within the heart of the city centre and forms part of the distinctive city centre quarters.</p>	<p>Average / Good</p>
<p>Developmental and Environmental Constraints (e.g. size; topography; site access; roads, lighting, landscaping, mains utilities and communications infrastructure; flood risk; contamination; nature and heritage conservation)</p>	<p>The site is broadly rectangular in shape and is generally flat following the Canal. The A6005 (Castle Boulevard) traverses east to west across the site.</p> <p>A review of Flood Maps for Planning (Gov.uk, 2021) shows majority of the site is located within a Flood Zone 2/Flood Zone 3 but benefits from flood defences).</p> <p>The quarter is full of historic sites including many buildings which are Grade and Locally listed (Historic England Listing Map, 2021; Nottingham City Local and National List, 2021).</p>	<p>Average</p>
<p>Barriers to Delivery and Mitigation</p>	<p>The site is located within an Air Quality Management Area (Policy IN2); Mineral</p>	<p>Poor</p>

(including ownership constraints - if known)	<p>Safeguarding Area (Local Plan Policy MI1); an Archaeological Constraints Area (Policy HE1, City Centre and Nottingham Canal); and within several Conservation Areas (Policy He1, Station Conservation Area and Nottingham Canal Conservation Area).</p> <p>The also contains several areas of land forming part of the open space network (Local Plan Policy EN1) and multiple cave allocations (Local Plan Policy HE2).</p>	
Market Attractiveness (including appropriateness, vacancy and market activity on site for the type of development proposed)	<p>The site has several vacancies:</p> <ul style="list-style-type: none"> • Castle Court 59 Castle Boulevard (self-contained office suites within a Grade II Listed building, to let (1,934 sq. ft. – 31,909 sq. ft., rent available upon application) (Innes England) • Courtyard 2 Arkwright Street, self-contained office suite to let (1,798 sq. ft., £12.00 per sq. ft.) (Innes England) <p>The agent describes the site as being in close proximity to occupiers such as he Nottingham Law Courts, the Land Registry and UPS. There are also a number of bars and restaurants with the properties being very accessible of transport links.</p>	Very Good
Strategic Fit with Growth Area Objectives (by target Market Segment)	<p>The following industrial growth sectors are already located within the site;</p> <ul style="list-style-type: none"> • Visitor Economy • Retail • Health/Social Care • Professional/Business Service <p>The site is located within the 'Regional Centre' of Nottingham (as identified in the D2N2 Vision 2030 document).</p>	Very Good
OVERALL SITE RATING	Good	
Recommendation and Potential Future Uses	<p>Protect the site for employment uses/mixed-use (i.e. retain current Local Plan designation as the Canal Quarter)</p> <p>The site should continue to focus on mixed-use development particularly with increasing housing provision within the city centre that directly increases footfall and helps the viability of the city. The site has the opportunity to continue planning for businesses such as offices that would benefit from the close proximity to the central train station. The site should also capitalise on the canal frontage, in particular with high quality public realm.</p>	

The Canal Quarter is within the ultimate heart of the city centre, spanning east to west across the city. The bordering quarters include the Castle Quarter to the north and the Creative and Island Quarters to the north-west. The Canal Quarter has distinctive sites throughout including the City's Train Station, multiple solicitor and law firms, HM Revenue and Customs, Nottingham Justice Centre and of course the canal itself. The Canal Quarter has multiple sites allocated for development, with a planning history to reflect the designations.

Given the list of notable employers within the site and the premises fulfilling a number of the industrial growth sectors targeted by D2N2, the site should be protected for employment uses/mixed-use and retain its allocation as the Canal Quarter. It is also recommended that the site continue to plan for mixed-use development with increasing city centre housing provision that will help increase city centre footfall and assist with the centre's viability.

Royal Quarter (Ref: NCC27)

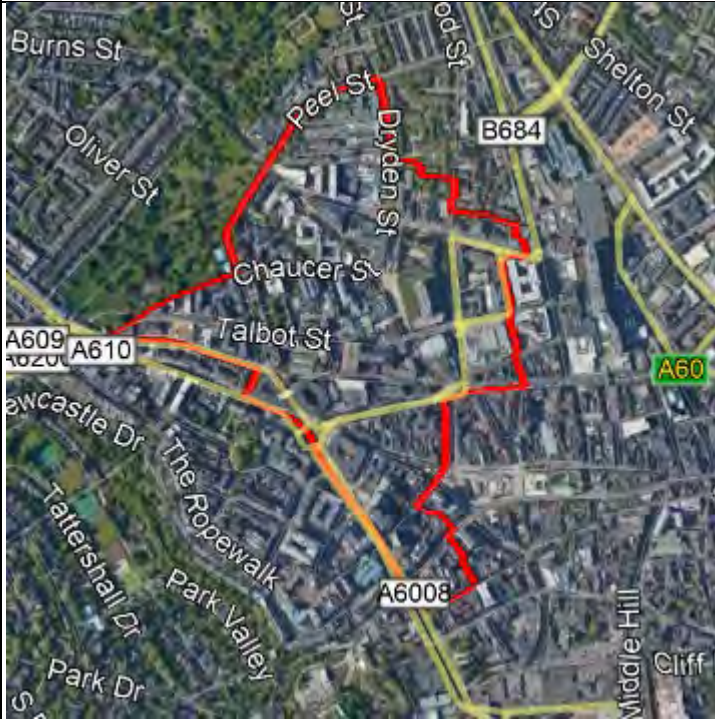

**GROSS SITE AREA:
33.62 ha**

**ESTIMATED NET DEVELOPABLE
AREA:
0 ha**

CRITERIA	COMMENT	RATING
<p>Site Context</p> <ul style="list-style-type: none"> • Location with regards to existing employment areas and other sites • How the site fits into the overall portfolio 	<p>The Royal Quarter is located to the north-east of the city centre, neighbouring the Castle Quarter to the south-east and the Creative Quarter to the south-west.</p> <p>Educational premises dominate the northern area of the site with Nottingham Trent University’s city centre campus and associated university facilities such as lecture halls, student accommodation and university libraries. The site is just to the north of the City’s shopping core.</p>	
<p>Local Plan Designation</p>	<p>The site is designated as the ‘Royal Quarter’ (Policy RE5) within the Nottingham City Land and Planning Policies Local Plan Part 2 (adopted January 2020) and illustrated on the Adopted Policies Map (City Centre).</p> <p>A site allocation is also designated in part of the site (Local Plan Policy SA1, SR51) for residential development (predominately family housing) and community uses with scope for employment.</p> <p>Other designations also include:</p> <ul style="list-style-type: none"> • Proposed Cycle Routes Safeguarding (Indicative)* (Policy TR3) • Partially in a Conservation Area (Policy HE1, Arboretum and Canning Circus) • Landmark Buildings (Policy DE2) • Focal Points (Policy DE2) • Caves (HE2) • Minerals Safeguarding Area (Local Plan Policy MI1) 	

	<ul style="list-style-type: none"> • Air Quality Management Area (Policy IN2) • Archaeological Constraints Area (Policy HE1, City Centre and Nottingham Canal and Old Market Square) • Proposed Pedestrian Environment Improvements (Policy TR2) • A number of landmark buildings (Local Plan Policy DE2) such as the Newton Building, Theatre Royal and Stanley House • Proposed Public Spaces (Indicative) (Policy DE3) • Supported the Growth of Further and Higher Education Facilities (Policy LS2)
Status in SHLAA	Site ID: 1963 Royal Quarter – Burton Street, Guildhall, Police Station and Fire Station (for 350 dwellings).
Planning History	<p>Recent planning history includes:</p> <ul style="list-style-type: none"> • 19/02426/PFUL3 - Conversion and extension of office building, including an additional storey, to student accommodation in a combination of shared apartments and studio apartments – Granted – 31.03.20 • 18/02215/PFUL3 - Change of use of vacant office building to student accommodation – Granted – 27.03.19 • 17/01620/PFUL3 - Demolition of former school and car showroom buildings. Construction of student accommodation development (of up to 9 storeys) comprising cluster flats and accessible studios, with communal facilities and a landscaped central courtyard – Granted – 10.05.18 • 17/00565/PFUL3 - 4 storey new build office and education building – Granted – 19.07.17 • 15/00888/PFUL3 - Demolition of existing derelict building and construction of new residential student development consisting of 77 beds in the form of Studios and multi bed accommodation units including communal areas to Lower Ground floor – Granted – 11.08.15 • 14/02526/PFUL3 - Demolition of buildings except for front section of Talbot House. Erection of new buildings (of up to 8 storeys) comprising studios, cluster flats, and accessible flats and conversion of front section of Talbot House to provide student facilities (revised scheme) – Granted – 02.04.15 • 14/02072/PFUL3 - Change of use from disused nightclub and offices to create approx. 353sq.m retail and 55sq.m office uses on ground floor, and conversion of upper floors to self-contained student accommodation units, including a two-storey roof top extension – Granted – 03.02.15
Current Use and Land Type	A large mixed-use city centre site containing some residential dwellings, shops, offices and hospitality venues,

	<p>but dominated by educational premises and associated offices, university buildings and student accommodation.</p> <p>In summary the premises predominantly fall within Use classes C3, D1, Sui Generis and E.</p>	
<p>Occupier Profile (if partly developed, including % of available land and levels of vacancy onsite)</p>	<p>Occupiers of the site include: Nottingham Trent University – Terrace Royal (Grade II Listed) university office building, Arkwright Building, Barnes Wallis Building, Belgrave Centre, Bonington Building, Bonington Gallery, Bookshop, Boots Library, Centre for Broadcasting & Journalism, Chaucer Building, City Sports Centre, Coffee Bars, Djanogly International Café, Dryden Centre, Employability Centre, Finance Office, Global Lounge, Health Centre, International Development Office, IoD Business Centre, Maudslay Building, Music Centre, Newton Building, Nottingham Conference Centre, Nottingham Language Centre, Nottingham Trent International College (NTIC), Occupational Health and Wellbeing, Prayer Facilities, Print Shop, Shops, Sir Harry and Lady Djanogly Lecture Theatre, Student Services Centre, the Hive, Waverley building, Gill Street North Student accommodation.</p> <p>The schools within the city centre campus include Nottingham Business School, Nottingham Law School, School of Social Sciences, School of Art & Design, School of Architecture, Design and the Built environment, School of Arts and Humanities.</p> <p>Premier Inn, Wagamama, Eon Offices, Cineworld IMAX, The Lost City Adventure Golf, Pizza Hut, TGI Fridays, Rock City (nightclub), Stanley House student accommodation, Arkwright Law Solicitors, Martin & Co., Callithome Limited (real estate investment), Elena’s Patisserie, Robinhood Energy, Aspendos Turkish Restaurant Tapas Bar, Kani Pizza, Nottingham City Council Central Library, Tesco Express, Pizza Express and Las Iguanas</p> <p>The following vacant premise was identified within the site:</p> <ul style="list-style-type: none"> • The Atrium, high quality office accommodation to let from 1,610 sq. ft. - 116,208 sq. ft 	
Strategic Road Access	The site is accessed from the A610 and A6008.	Average
Local Road Access	The site is accessed of from the A6008, travel along Goldsmith Street is restricted to the tram only.	Average
Proximity to Urban Areas and Access to Labour and Services (including public transport / cycling / walking accessibility)	<p>Located within the city centre, the site has a range of retail and food premises for consumers.</p> <p>The Royal Quarter has very good pedestrian</p>	Very Good

	<p>infrastructure the connects the site to the wider city.</p> <p>The site is well served by public transport with bus services to Ripley, Cotmanhay, Alferton, Heanor, Basford, Keyworth, Dunkirk and Nottingham University Main Campus.</p> <p>The university benefits from the Nottingham Trent University Tram stop which provides services towards Toton Lane, Hucknall, Phoenix Park and Clifton South.</p>	
<p>Compatibility of Adjoining Uses (including amenity impacts experienced by current/future occupiers and neighbouring areas)</p>	<p>The site is located within the heart of the city centre and forms part of the distinctive city centre quarters.</p>	<p>Average / Good</p>
<p>Developmental and Environmental Constraints (e.g. size; topography; site access; roads, lighting, landscaping, mains utilities and communications infrastructure; flood risk; contamination; nature and heritage conservation)</p>	<p>The site is an irregular shape, with generally inclining topography heading north from Talbot Road and declining towards the inner city.</p> <p>A review of Flood Maps for Planning (Gov.uk, 2021) shows the site is not located within a flood zone.</p> <p>A number of listed and locally listed buildings are scattered throughout the site (Historic England Listing Map, 2021; Nottingham City Local and National List, 2021).</p>	<p>Average</p>
<p>Barriers to Delivery and Mitigation (including ownership constraints - if known)</p>	<p>The site is located within an Air Quality Management Area (Policy IN2); Mineral Safeguarding Area (Local Plan Policy MI1); an Archaeological Constraints Area (Policy HE1); with part of the site within a Conservation Area (Policy HE1, Arboretum and Canning Circus)</p> <p>The site also contains multiple cave allocations and landmark buildings (Policy DE2 and HE2).</p>	<p>Poor</p>
<p>Market Attractiveness (including appropriateness, vacancy and market activity on site for the type of development proposed)</p>	<p>Generally, the site has limited vacancies.</p> <p>The Atrium is advertised by FHP as high-quality accommodation to let from 1,610 sq. ft. – 16,208 sq. ft (£25,760 - £259,328 p. a.).</p>	<p>Very Good</p>
<p>Strategic Fit with Growth Area Objectives (by target Market Segment)</p>	<p>The following industrial growth sectors are already located within the site:</p> <ul style="list-style-type: none"> • Visitor Economy • Retail • Professional/business service <p>The site is located within the 'Regional Centre' of</p>	<p>Very Good</p>

	Nottingham (as identified in the D2N2 Vision 2030 document).	
OVERALL SITE RATING	Good	
Recommendation and Potential Future Uses	<p>Protect the site for employment uses/mixed-use (i.e. retain current Local Plan designation as the Royal Quarter)</p> <p>The site should continue to support University operations within the Royal Quarter. This should include delivering high quality student accommodation and educational facilities. Any development should enhance and preserve the many heritage assets across the site. There is also scope to continue providing hospitality premises within the site for both the day and night time economy.</p>	
SITE SUMMARY:		
<p>The Royal Quarter is located to the north-east of the city centre, neighbouring the Castle Quarter to the south-east and the Creative Quarter to the south-west. Educational premises dominate the northern area of the site with Nottingham Trent University city centre campus and associated university facilities such as lecture halls, student accommodation and university libraries.</p> <p>The site is just to the north of the City's shopping core. Other notable occupiers of the site include Premier Inn, Eon Offices, Cineworld IMAX, Rock City (nightclub) and Nottingham City Council Central Library. The site has limited vacancies with an active planning history which reflects ongoing interest and development of the site for a wide variety of uses including office.</p> <p>Given the above characteristics of the site and the site fulfilling a number of the industrial sectors targeted by D2N2, the site should be protected for employment uses/mixed-use and retain its allocation as the Royal Quarter. This should include delivering high quality student accommodation and educational facilities. Any development should enhance and preserve the many heritage assets across the site.</p>		

Land north of Bingham (Ref: RBC1)

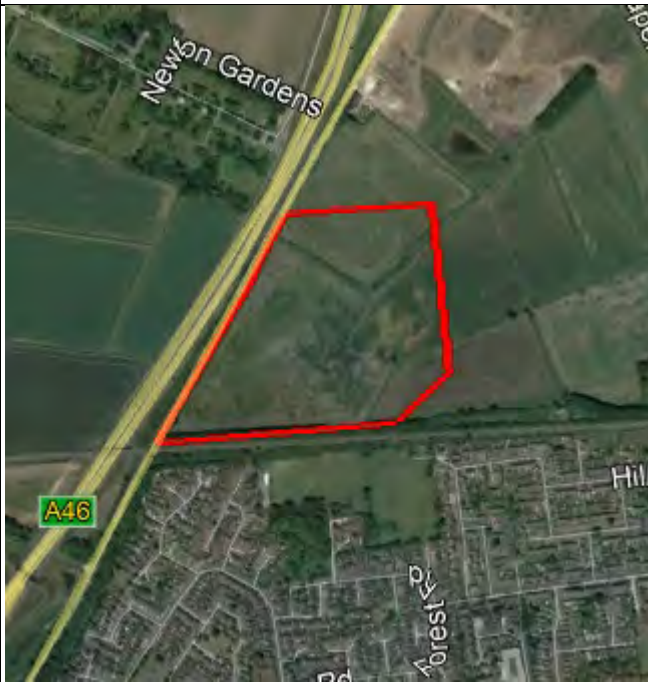

GROSS SITE AREA:
15.5 ha

ESTIMATED NET DEVELOPABLE AREA:
14.16 ha

CRITERIA	COMMENT	RATING
<p>Site Context</p> <ul style="list-style-type: none"> • Location with regards to existing employment areas and other sites • How the site fits into the overall portfolio 	<p>This is a greenfield site set within a wider strategic allocation to the north of Bingham. The residential development is being implemented and this site has outline planning permission for employment uses. The area identified for employment uses also includes land to the north of the site. The site is located approximately 700m west of the established Moorbridge Industrial Estate which is to be retained within the wider allocation.</p>	
<p>Local Plan Designation</p>	<p>The development plan for Rushcliffe consists of the Local Plan Part 1: Core Strategy (Adopted December 2014), Adopted Policies Map and the Local Plan Part 2: Land and Planning Policies (Adopted October 2019).</p> <p>The site is included within the Bingham Neighbourhood Plan Area map, but a draft has not yet been produced.</p> <p>The site is identified in the policy map as a strategic allocation (LP1 Policy 20-25); this area also includes the new residential development 'Roman Quarter' to the north and land to the east. Green Belt land lies to the north of Fosse Road.</p> <p>Local Plan Policy 21 Strategic Allocation at Land North of Bingham identifies the land as a strategic site for around 1000 dwellings, around 15.5 ha of B1, B2 and B8 employment uses, a neighbourhood centre and other appropriate community facilities. It sets out that the employment uses should be concentrated adjacent to the west of the site in proximity to the A46 and the existing employment (at the Moorbridge Industrial Estate) to the east should be retained.</p>	

	The site is identified for employment development.	
Status in SHLAA	The SHLAA Report 2019 (January 2020) identified the wider strategic site 'Land north of Bingham' (SHLAA ref. SHLAA/BIN/015) as available, suitable and achievable now - delivery commenced in 2018.	
Planning History	<p>The site is within a wider strategic site, the residential elements are being implemented and this site has outline planning permission for employment uses. The area identified for employment uses also includes the land to the north of the site.</p> <p>Recent planning history includes;</p> <ul style="list-style-type: none"> • 10/01962/OUT – Outline planning application - Up to 1050 residential dwellings (C3); 15.6 hectares of employment development (B1, B2 and B8) totalling 53,800 sqm; local centre comprising up to 300m sq of retail floor space (A1); primary school (D1); and community centre (D2); a 1.6 hectare mixed use site (B1, B2, B8 and car parking); allotments and open space (including play areas and community park); flood management and drainage works; transport and access works; and ancillary works – Granted 24.12.2013 • 17/02106/REM – Reserved matters application - Reserved matters application for 317 residential dwellings (phase 1 of the wider approved development as originally approved under application 10/01962/OUT) including details of access, appearance, landscaping, layout and scale of development – Granted 12.02.2018 • 18/01468/REM – Reserved matters application - Reserved matters submission for 733 residential dwellings (Phase 2 of the wider approved development as originally approved under application 10/01962/OUT) including details of access, appearance, landscaping, layout and scale of development – Granted 19.06.2018 	
Current Use and Land Type	This is an undeveloped grassland site.	
Occupier Profile (if partly developed, including % of available land and levels of vacancy onsite)	N/A - the site is available for development.	
Strategic Road Access	The site is adjacent to Fosse Road with the A46 immediately to the north. There are junctions within approximately 1.5km to the north and south of the site which connect the Fosse Road to the A46. The A1 is 22.5 km away via the A52 which can be accessed 1km South from the site.	Average

<p>Local Road Access</p>	<p>There is an access track to the site from Fosse Road. The site is undeveloped with no access infrastructure in place. Fosse Road is a good, free-flowing road. However, it is constricted by a restricted-height railway bridge (max height 4.6m) to the South of the site.</p> <p>The A46 runs adjacent to the west of the site and continues north towards Newark upon Trent and south towards Leicester. The A52 can be accessed via two junctions approximately 1.5km to the north and south of the site.</p>	<p>Poor</p>
<p>Proximity to Urban Areas and Access to Labour and Services (including public transport / cycling / walking accessibility)</p>	<p>The site is situated to the north of the town of Bingham which provides schools, a medical centre, shops and a leisure centre.</p> <p>There are bus stops along Foss Road adjacent to the site which provide bus services every 1-2 hours between Bingham/ Bingham railway station and Newark Monday to Saturday between 7:30am and 3pm. Bingham Railway Station is approximately 3km to the east.</p>	<p>Average</p>
<p>Compatibility of Adjoining Uses (including amenity impacts experienced by current/future occupiers and neighbouring areas)</p>	<p>The site is bordered by greenfield land with new residential development (Roman Quarter) beyond to the North, greenfield land to the East, Fosse Road and the A46 with greenfield land and the Former RAF Newton base beyond to the West and the East Midlands Railway to the South with residential areas beyond.</p>	<p>Average</p>
<p>Developmental and Environmental Constraints (e.g. size; topography; site access; roads, lighting, landscaping, mains utilities and communications infrastructure; flood risk; contamination; nature and heritage conservation)</p>	<p>This is a relatively level site with the railway line adjacent to the southern boundary. There is a culvert under Fosse Road and a drainage channel with a footpath adjacent, which intersect the site from Fosse Road to the south east.</p> <p>There is also a drain running along the site's western boundary. The south eastern corner of the site is within Flood Zone 3 and therefore at high risk of flooding, the remainder of the site is within Flood Zone 1 and therefore at a low risk of flooding.</p> <p>The site has potential for the identification of archaeological remains. There are no heritage assets or environmental designations within the site or the immediate surrounds.</p>	<p>Average / Good</p>
<p>Barriers to Delivery and Mitigation (including ownership constraints - if known)</p>	<p>The site has outline planning permission for employment uses and is in the ownership of the Crown Estate. The Flood Risk to the south east of the site would need to be mitigated.</p>	<p>Good</p>

<p>Market Attractiveness (including appropriateness, vacancy and market activity on site for the type of development proposed)</p>	<p>This site is an undeveloped greenfield site within a wider sustainable urban extension strategic allocation to the north of Bingham. The site has outline permission for employment uses and the residential development on the wider site is being delivered. The site is highly visible from the A46.</p>	<p>Good</p>
<p>Strategic Fit with Growth Area Objectives (by target Market Segment)</p>	<p>This site has potential to meet local employment requirements and accommodate key industrial growth sectors as identified in the D2N2 Vision 2030 document.</p>	<p>Good</p>
<p>OVERALL SITE RATING</p>	<p>Good</p>	
<p>Recommendation and Potential Future Uses</p>	<p>Allocate for employment uses (i.e. retain current Local Plan Part 1 strategic allocation 'Land North of Bingham' designation)</p>	
<p>SITE SUMMARY:</p>		
<p>This site is an undeveloped greenfield site within a wider sustainable urban extension strategic allocation to the north of Bingham. The site has outline permission for employment uses and the residential development on the wider site is being delivered. The strategic allocation includes 15.6 hectares of employment development comprising of 53,800 sqm Class E(g), B2 and B8 floorspace and includes land immediately north of the site. It is considered that this would be an attractive site for employment development and it is recommended to allocate the for employment uses and that the current strategic allocation (Policy 21) is retained to enable the site to come forward.</p>		

RAF Newton (Ref: RBC2)



**GROSS SITE AREA:
21.62 ha**

**ESTIMATED NET DEVELOPABLE
AREA:
10.67 ha**

(Note: this incorporates the undeveloped eastern portion of the site only (11.86 ha gross) and is based on a gross to net ratio of 90%)

CRITERIA	COMMENT	RATING
<p>Site Context</p> <ul style="list-style-type: none"> • Location with regards to existing employment areas and other sites • How the site fits into the overall portfolio 	<p>This site comprises of areas within the former RAF Newton Airfield. The western site comprises of hangars associated with the former airfield use and the eastern site comprises of Newton Gardens. The wider site has planning permission for up to 500 dwellings, 50 live/work units and 5.22 ha of employment uses with the proposed retention of the existing hangars for employment purposes.</p> <p>To the eastern side of the A46 is the strategic allocation 'Land north of Bingham' with an extant permission for up to 1,050 residential dwellings and 15.6 hectares of employment development (ref. 10/01962/OUT). The Moorbridge Industrial estate is approximately 3km south east of the site.</p>	
<p>Local Plan Designation</p>	<p>The development plan for Rushcliffe consists of the Local Plan Part 1: Core Strategy (Adopted December 2014), Adopted Policies Map and the Local Plan Part 2: Land and Planning Policies (Adopted October 2019).</p> <p>The appraisal site and wider RAF Newton site is allocated as a strategic site Local Plan 1 Policy 22. The area surrounding this is identified as Green Belt – Local Plan Part 1 Policy 4, Local Plan Part 2 Policy 21.</p> <p>Local Plan Part 1 Policy 22 Strategic Allocation at RAF Newton identifies the site for around 550 dwellings, protection of existing B8 employment located within the</p>	

	<p>former aircraft hangars, and the provision of additional employment land (c. 6.5ha) for E, B2 and B8 purposes.</p> <p>In addition, a primary school, community centre, public open space and other facilities as appropriate. The indicative distribution of uses identifies the appraisal sites for employment uses.</p>
Status in SHLAA	The SHLAA Report 2019 (January 2020) identified the wider RAF Newton strategic site 'Land at RAF Newton Phase 2' (SHLAA ref. SHLAA/NEW/002) delivery has been delayed however, the site has been cleared of former MOD buildings and delivery is expected within 5 years.
Planning History	<p>Recent planning history includes:</p> <ul style="list-style-type: none"> • 10/02105/OUT – Outline planning application - Outline proposals with all matters reserved seeking the delivery of: up to 500 dwellings; up to 50 live/work units; up to 5.22ha of new employment land (E, B2 & B8); up to 1000sqm of space for ancillary A1, A3, & A4 uses and community uses; retention of existing hangars for employment purposes; a perimeter cycle track; provision of land for new primary school; and associated public open space, recreation space and landscaping – Granted 30.01.2014 The residential element of the proposals is outside the appraisal site boundary. • 15/00583/VAR – Variation or removal of conditions - Vary/remove various conditions relating to 10/02105/OUT to enable demolition of existing building in advance of commencement of development and to facilitate the delivery of the development in a phased manner and to enable conditions to be discharged in accordance with an identified phase – Granted 29.07.2015 • 19/02689/REM - Reserved matters application for outline permission 19/01871/VAR to seek approval for the access, appearance, landscaping, layout and scale of the residential development – Granted 04.08.2020 • Multiple applications have also been submitted to discharge conditions.
Current Use and Land Type	This is a brownfield site and Former RAF Newton Airfield. The site comprises of hangars associated with the former airfield use to the west and Newton Gardens to the east. The land between the sites is subject to a recent planning permission (ref. 19/02689/REM) for residential uses and is now being cleared for development.
Occupier Profile (if partly developed, including % of available land and levels of vacancy onsite)	The eastern site is known as Newton Gardens and comprises of woodland and grassland. The western site comprises of aircraft hangars associated with the former RAF airfield use. Occupiers of the hangars include Babcock International

	Group (training office) and Highlight Horticulture (agricultural product distribution).	
Strategic Road Access	There is a junction within 1.5km to the north of the site which connects the site's access road (Newton Lane) to the A46. The A52 is also accessible via the A46 approximately 4km to the south.	Average
Local Road Access	The site can be accessed from the north via Main Street then Wellington Avenue, through the Newton residential area. The site can also be accessed via Newton Lane to the south east. Newton Lanes provides easy access to the adjacent A46.	Average
Proximity to Urban Areas and Access to Labour and Services (including public transport / cycling / walking accessibility)	The site is in a rural location situated within the hamlet of Newton which does not offer any services or facilities except for bus stops. It is located to the north east of the town of Bingham and to the south of the village of East Bridgford. Both towns provide schools, medical centre and shops with Bingham also providing a leisure centre. There are bus stops located on Wellington Avenue within 400m of the site, with regular services to Nottingham, Newark and Bingham/Bingham railway station.	Poor / Average
Compatibility of Adjoining Uses (including amenity impacts experienced by current/future occupiers and neighbouring areas)	The site is part of a former RAF airfield. The Western section is bordered to the north, south and west by greenfield land and by uses associated with the former airfield to the east with Newton hamlet residential area beyond. The eastern section is bordered by greenfield land to the north and south, the former airfield site to the west and Newton Lane to the east with the A46 beyond.	Average
Developmental and Environmental Constraints (e.g. size; topography; site access; roads, lighting, landscaping, mains utilities and communications infrastructure; flood risk; contamination; nature and heritage conservation)	The site is within Flood Zone 1 and therefore at low risk of flooding. There is a public footpath running adjacent to the northern boundary of the eastern site, There are a number of Listed Buildings within approximately 400m north of the western site: <ul style="list-style-type: none"> • Yew Tree Farmhouse and attached barn - Grade II Listed – ref. 1039575 • White House – Grade II Listed – ref. 1039571 • Range of three barns at White House – Grade II Listed – ref. 1250077 	Good
Barriers to Delivery and Mitigation (including ownership constraints - if known)	Infrastructure requirements for the site have been considered through the Local Plan Part 2: Infrastructure Delivery Plan (May 2018) and subsequent planning application. A barrier to	Average

	delivery is the need to widen the access road to the site to industrial width.	
Market Attractiveness (including appropriateness, vacancy and market activity on site for the type of development proposed)	The employment space will include the former aircraft hangers as well as new space to the west of the A46. Due to the relatively isolated nature of this site, it is more suited to meeting local employment needs in the surrounding areas including Newton, East Bridgford and Bingham. The hangars are to be retained and there are existing tenancies in place. The hangars are likely to be more attractive for B8 warehousing users. Whilst the residential development is being progressed, it is understood that the employment element of the extant permission is not currently being progressed for now.	Average
Strategic Fit with Growth Area Objectives (by target Market Segment)	This site has the potential to accommodate key industrial growth sectors as identified in the D2N2 Vision 2030 document.	Average
OVERALL SITE RATING	Average	
Recommendation and Potential Future Uses	Allocate for employment uses (i.e. retain current Local Plan Part 1 strategic allocation for employment use as part of a wider mixed-use development)	
SITE SUMMARY:		
<p>This site comprises of areas within the former RAF Newton Airfield. The western site comprises of hangars associated with the former airfield use and the eastern site comprises of Newton Gardens. The wider site has planning permission for up to 500 dwellings, 50 live/work units and 5.22 ha of employment uses with the proposed retention of the existing hangars for employment purposes. The residential development is now being delivered but the employment development is not being progressed and there may be delivery issues with widening of the access road and potential viability issues. The wider RAF Newton site is allocated as a strategic site (Local Plan Part 1 Policy 22 Strategic Allocation at RAF Newton) for around 550 dwellings, protection of existing B8 employment located within the former aircraft hangars, and the provision of additional employment land (c. 6.5ha) for E (offices), B2 and B8 purposes.</p> <p>It is recommended that the site be allocated for employment uses and the current Local Plan Part 1 strategic allocation is retained to protect existing and proposed employment space.</p>		

Ruddington Fields Business Park (Ref: RBC3)



GROSS SITE AREA:
22.37 ha

ESTIMATED NET DEVELOPABLE AREA:
0 ha

CRITERIA	COMMENT	RATING
<p>Site Context</p> <ul style="list-style-type: none"> • Location with regards to existing employment areas and other sites • How the site fits into the overall portfolio 	<p>This is a well-established, successful and modern business park accommodating a range of professional and business services as well as some manufacturing and logistics uses. The site is adjacent to Rushcliffe Country Park and the Great Central Railway Nottingham heritage centre. The site, which was built out in the early 2000s, is the only business park within Rushcliffe considered to be of a strategic scale.</p>	
<p>Local Plan Designation</p>	<p>The development plan for Rushcliffe consists of the Local Plan Part 1: Core Strategy (Adopted December 2014), Adopted Policies Map and the Local Plan Part 2: Land and Planning Policies (Adopted October 2019).</p> <p>The site is within the development boundary of Ruddington but is not allocated. It is encircled by Green Belt (LP1 Policy 4; LP2 Policy 21).</p> <p>The site is within the Ruddington Neighbourhood Plan area and the draft Plan was consulted upon in December 2020.</p>	
<p>Status in SHLAA</p>	<p>The site was not submitted to the Strategic Housing Land Availability Assessment Report 2019 (January 2020). Land on the eastern side of the A60 was submitted for 1,200 homes (ref. SHLAA/RUD/001) but the delivery of this site is unknown.</p>	
<p>Planning History</p>	<p>There are a number of planning applications in relation to employment uses on the site. Recent planning history includes:</p>	

- 19/01677/NMA – Non-material amendment - Non material amendment to planning permission 19/00547/FUL to allow the lowering of the finished floor level; the repositioning of vehicular access, car park and the building; changes to the layout of the building, the roof and the drainage layout; provision of 9 car parking spaces and alterations to the fenestration of the building – Refused – 12.07.2019
- 19/02117/NMA – Non-material amendment - Non material amendment to planning permission 19/00547/FUL to allow the lowering of the finished floor level; the repositioning of vehicular access and the building; changes to the layout of the building, the roof angle and the drainage layout and alterations to the fenestration of the building (resubmission) – Granted 11.10.2019
- 19/02929/FUL – Full planning application – Construction of 2 no. office blocks including undercroft parking – Granted 08.04.2020
- 19/00547/FUL – Full planning application - Erection of multi-storey car park to service existing and approved office developments (revised scheme – Granted 16.05.2019
- 19/01516/FUL – Full planning application – Retention of two portable buildings for a temporary period of 3 years – Granted 06.08.2019
- 18/01698/FUL – Full planning application – Erection of multi-storey car park to service existing and approved office developments – Granted 01.02.2019
- 18/02807/COU – Change of use application - Change of use from offices (B1) to offices, laboratory, ward accommodation and clinical space (sui generis) – Granted 14.02.2019
- 17/01107/FUL – Full planning application – Take down existing front canopy and replace with new front entrance and canopy, and proposed new windows – Granted 05.07.2017
- 17/01294/NMA – Non-material amendment - Variation of conditions imposed on permission 10/01313/FUL to permit revisions to elevations and layout, changes to materials, variation of surface water limitation scheme and removal of requirement to complete works to A60 roundabout prior to occupation (vary condition 4 of planning permission 16/01957/VAR to substitute correct drawing number and permit phased delivery of car parking) – Granted 12.07.2017
- 16/01383/FUL – Full planning application - Retention of two portable buildings for a temporary period of 3 years – Granted 19.07.2016
- 16/00844/FUL – Full planning application - Material alterations to the external building envelope of existing office building including new windows and

	roof lights. Creation of 25 additional car parking spaces. – Granted 29.06.2016	
Current Use and Land Type	This is a brownfield site and an established business park.	
Occupier Profile (if partly developed, including % of available land and levels of vacancy onsite)	<p>Majority of the site is in use as offices; however, there is also storage and distribution and a training centre for mechanics. There were no vacant units during the site visit (December 2020).</p> <p>Occupiers include:</p> <ul style="list-style-type: none"> • Ideagen (professional/business services) • Kuehne + Nagel (logistics) • Vision Express (healthcare head office) • Capita (software company) • Experian (data centre) • Quotient Sciences (pharmaceutical company) • GeoSlam (research and development) • Greene, Tweed & Co. (manufacturing of high-performance materials and custom-engineered components) • MHR (HR and payroll) • Emtec Colleges Limited (automotive education and training) • Kingdom Bank • Assemblies of God Bank 	
Strategic Road Access	The site is accessed via Mere Way which leads directly off the A60. The A60 is a good free-moving road which joins the A52 after 2.4km travelling North of the site and, to the South, continues to Loughborough. Junction 24 of the M1 is approximately 16km to the South West	Average
Local Road Access	The site is accessed via Mere Way spine road and roundabout from the A60.	Very Good
Proximity to Urban Areas and Access to Labour and Services (including public transport / cycling / walking accessibility)	<p>The site is situated 1.6km to the South of the residential Village of Ruddington which provides schools, a medical centre, shops and other local amenities and services.</p> <p>There are regular bus services from the entrance to the site on the A60 – Northbound to Nottingham and Southbound to Loughborough</p>	Average
Compatibility of Adjoining Uses (including amenity impacts experienced by current/future occupiers and neighbouring areas)	The site is bound by mature trees with greenfield land beyond to the South and East, Rushcliffe Country Park and Great Central Railway (Nottingham) to the West/North West and recreational fields to the North. The A60 Loughborough Road is located to the east. The site is encircled by the Green Belt.	Very Good

<p>Developmental and Environmental Constraints (e.g. size; topography; site access; roads, lighting, landscaping, mains utilities and communications infrastructure; flood risk; contamination; nature and heritage conservation)</p>	<p>This is a large, level site occupied by an established business park with utilities and communications infrastructure in place.</p> <p>There are no known environmental constraints. The site is within Flood Zone 1 and therefore at a low risk of flooding. The Rushcliffe Country Park Local Nature Reserve wraps around the site.</p>	<p>Very Good</p>
<p>Barriers to Delivery and Mitigation (including ownership constraints - if known)</p>	<p>The site has numerous owners. The site is fully developed and no potential developmental constraints were apparent during the site visit</p>	<p>Good</p>
<p>Market Attractiveness (including appropriateness, vacancy and market activity on site for the type of development proposed)</p>	<p>This is a well-established and successful business park with low vacancy levels.</p>	<p>Very Good</p>
<p>Strategic Fit with Growth Area Objectives (by target Market Segment)</p>	<p>This site already accommodates key industrial growth sectors as identified in the D2N2 Vision 2030 document and has the potential to accommodate additional businesses within these sectors. Key sectors already accommodated on the site include:</p> <ul style="list-style-type: none"> • Logistics & E-Commerce • Transport Equipment Manufacturing • Health/Social Care • Professional/Business 	<p>Good</p>
<p>OVERALL SITE RATING</p>	<p>Very Good</p>	
<p>Recommendation and Potential Future Uses</p>	<p>Protect for employment uses</p>	
<p>SITE SUMMARY:</p>		
<p>This is a well-established, popular, successful and modern business park accommodating a range of professional and business services as well as some manufacturing and logistics uses, with no vacant units. The site is adjacent to Rushcliffe Country Park and the Great Central Railway Nottingham heritage centre. The site is the only business park within Rushcliffe considered to be of a strategic scale.</p>		
<p>The site is within the development boundary of Ruddington but is not allocated. It is encircled by Green Belt (LP1 Policy 4; LP2 Policy 21) and the Rushcliffe Country Park Local Nature Reserve. It is recommended that this site is protected for employment uses.</p>		

Ratcliffe-on-Soar Power Station (Ref: RBC4)



**GROSS SITE AREA:
275.75 ha**

**ESTIMATED NET DEVELOPABLE
AREA:
206.81 ha**

(Note: this is Based on a net to gross ratio of 75% - the rail link and national grid buildings would be retained. Areas of the site will be available at different times with the main station not being decommissioned till 2025.)

CRITERIA	COMMENT	RATING
<p>Site Context</p> <ul style="list-style-type: none"> • Location with regards to existing employment areas and other sites • How the site fits into the overall portfolio 	<p>This site is occupied by the Uniper Energy Ratcliffe-on-Soar Coal-Fired Power Station. The A453 Remembrance Way intersects the site from east to west. The northern portion of the site accommodates the main power station and goods railway line access. The southern portion of the site is currently in use for ash reclamation. The East Midlands Parkway Railway Station is adjacent to the site to the west and the River Trent is adjacent to the site to the North.</p> <p>The site was commissioned in 1968 and has previously operated 24/7 with up to 1,000 people working on-site. However, the site is now operating in more of a reserve capacity and it is due to be decommissioned in 2025.</p> <p>A representative of Uniper Ratcliffe Redevelopment advised that Uniper are working with the East Midlands Development Corporation on proposals for transforming the site into ZERO, a global research centre that will develop real-world low-emission technologies, which open up new business markets and help the UK hit its climate change targets.</p> <p>The site is part of the East Midlands Airport FreePort, one of 8 designated by the Government in</p>	

	<p>its March 2021 Budget with the aim of reducing administrative burdens and tariff controls, provide relief from duties and import taxes, and ease tax and planning regulations.</p> <p>Areas of the site can be brought forward ahead of the decommissioning of the main site including the southern ash fields site and areas within the northern site. It is understood that the site south of the A453 comprising of approximately 106 ha of land in use for ash recovery is available now. Areas within the main site north of the A453 are able to come forward prior to the decommissioning of the main plant in 2025.</p> <p>A planning application (ref. ES/4154) has been submitted to Nottinghamshire County Council for the redevelopment of the north-eastern corner of the site (currently in use as car parking) for the East Midlands Energy Re-Generation (EMERGE) Centre which would generate energy from domestic and commercial waste leftover from recycling. The rail link and national grid substations would be retained in any future redevelopment of the site.</p> <p>Other nearby East Midlands Development Corporation projects include creating an inland freeport at East Midlands Airport and the Toton HS2 hub station and development of a new community and innovation district around this.</p> <p>Furthermore, new plans are being put forward by the Government for three tram extensions, new train lines and stations and better transport connections in the region. This includes a tram extension from Long Eaton to Ratcliffe Power Station and the employment hub at East Midlands Gateway.</p> <p>This is an important employment site for the region and a key employer.</p>
<p>Local Plan Designation</p>	<p>The development plan for Rushcliffe consists of the Local Plan Part 1: Core Strategy (Adopted December 2014), Adopted Policies Map and the Local Plan Part 2: Land and Planning Policies (Adopted October 2019).</p> <p>The site is identified in the policy map as being within the Green Belt (Local Plan Part 1 - Policy 4, Local Plan Part 2 - Policy 21). The HS2 Safeguarded Route intersects the northern portion of the site.</p> <p>The River Soar is identified in the policies map for Sustainable Tourism and Leisure (LP2 Policy 31) and flows into the River Trent adjacent to the western site boundary. A Strategic Allocation – South of Clifton is located to the north-east of the site.</p>

<p>Status in SHLAA</p>	<p>The site was not submitted to the Strategic Housing Land Availability Assessment Report 2019 (January 2020). However, land to the north-east of the site is identified as a Strategic Allocation 'South of Clifton' and has outline planning permission for up to 3,000 dwellings and 100,000 sqm of employment floorspace. Reserved planning permission has been granted for the first phases.</p> <p>Furthermore, land to the south and east of the southern portion of the site was submitted to the SHLAA (site name: Land to the east of Kingston on Soar and South of Ratcliffe-on-Soar Power Station, site ref. SHLAA/KOS/004) and comprises of 358.1 ha with a capacity for 6,000 dwellings. In addition, land to the east of the site and the A453 was also submitted to the SHLAA (site name: Land South of Clifton, site ref: SHLAA/BIF/002) and comprises of 230.5 ha with capacity for 3,000 dwellings.</p>
<p>Planning History</p>	<p>The planning history is split across the site, with recent applications including:</p> <p>Main Site:</p> <ul style="list-style-type: none"> • 20/01826/CTY – County Regs 3 - Proposed development of the East Midlands Energy Re-Generation (EMERGE) Centre (a multifuel Energy Recovery Facility, recovering energy from waste material) and associated infrastructure – No Objection 12.10.2020 (NCC ref. ES/4154) • 18/00366/FUL – Full planning application - Covered coal storage and handling enclosure within existing coal stock area – Granted 26.03.2018 • 12/01486/FUL – Full planning application - Erection of security fence and security building (accommodation works for A453 widening by Highways Agency) – Granted 19.10.2012 • 12/01174/FUL – Full planning application – Refurbish Link Bridge – Granted 12.09.2012 • 09/01686/FUL – Full planning application - Storage Building – Granted 05.11.2009 • 07/02541/FUL – Full planning application - Construct 4 workshops/fabrication shops – Granted 01.02.2008 • 07/02511/HAZARD – Hazardous Substances Application - Application for Hazardous Substance Consent for the existing storage of fuel oil greater than 500 tonnes to be used during start up of the boiler furnaces, and for ammonia (max. 167 tonnes) to be used for the purpose of process control at the facility – Granted 23.06.2008 • 07/02038/FUL – Full planning application - Installation of emissions abatement technology – Granted 08.11.2007 • 06/00709/FUL – Full planning application - Erect 3.4m security fence – Granted 31.08.2006

	<ul style="list-style-type: none"> • 05/01382/FUL – Full planning application - Extend redundant chemical storage bund to form covered storage area – Granted 05.12.2005 • 04/01362/FUL – Full planning application - Erection of two, 600 tonne capacity storage silos and transfer equipment and switch rooms – Granted 21.10.2004 • 03/01421/FUL – Full planning application - Construct 2 new silos, new unloading bay and new storage shed for multi fuel unloading and storage – Granted 30.03.2004 <p>Ash Area 1;</p> <ul style="list-style-type: none"> • 07/00417/REM – Reserved Matters Application - Construct new parkway railway station with park and ride capacity for up to 1000 cars and associated access/highway works – Granted 22.10.2007 • 01/00886/FUL – Full planning application - Earthworks/flood compensation works to facilitate construction of new station, car park and access – Withdrawn • 00/00656/OUT – Outline Planning Application - Construction of new parkway railway station with park and ride capacity for up to 1000 cars and associated access/highway works – Granted 21.11.2002 <p>Ash Area 2;</p> <ul style="list-style-type: none"> • 10/01610/CMA – County Matter - Variation of condition 4 of planning permission 8/99/00131/CMA to extend period for disposal of FGD gypsum. Condition 2 of planning permission 8/02/01345/CMA for revision to restoration proposals Winking. – No Objection 14.10.2010 • 93/00611/CMA – County Matter – Disposal of FGD gypsum – No Objection – 21.01.1994 • 91/00879/P1P - Revised finished levels and landscaping scheme Winking Hill Ash Disposal Site.
<p>Current Use and Land Type</p>	<p>This is a part brownfield/part greenfield site occupied by the Ratcliffe-on-Soar Power Station and associated buildings together with areas of land to the south of the A453 used for the recovery of ash. The ash disposal areas to the south of the A453 have restorative conditions on them to revert back to farmland under permission 91/00879/P1P which has largely been completed. The power station is due to be decommissioned by the end of 2025. The site is rail connected. County matters energy from waste application under consideration at present on part for the site 20/01826/CTY.</p>
<p>Occupier Profile (if partly developed, including % of available land and levels of vacancy onsite)</p>	<p>The site is occupied by Uniper Energy Ratcliffe-on-Soar Power Station. There are two national grid substations, two gas turbines, chemical storage for liquid ammonia, a substantial coal stock, an engineering academy, technology services building and office buildings on the site. There is a</p>

	direct access rail line into the site branching off from the mainline (which connects to East Midlands Parkway immediately to the west). The site has an abstraction licence from the River Soar.	
Strategic Road Access	The site is adjacent to and accessed via the A453. Junction 24 of the M1 is approximately 3.5 km South West of the site and the A52 approximately 10km North West of the site. The A50 is approximately 3.5 km from the site and the A6 is approximately 5km from the site.	Good
Local Road Access	The main entrance to the site is to the south off the A453 with two HGV accesses to the north off the A453. There are two underpasses from the northern portion of the site under the A453 to the southern portion of the site. The southern portion of the site can be accessed from the east via West Leake Lane and to the west via Kegworth Road. The A453 is a good free-flowing road which, from the site, leads directly onto junction 24 of the M1 in a South Westerly direction	Very Good
Proximity to Urban Areas and Access to Labour and Services (including public transport / cycling / walking accessibility)	<p>The site is 5km from the residential town of Kegworth via the A453 or Kegworth Road. Kegworth provides schools, a medical centre, local shops and takeaway and a number of hotels servicing the nearby East Midlands Airport (7.9km from the site). Clifton, Nottingham is approximately 10km from the site via Remembrance Way (A453) and the town of Long Eaton is approximately 14 km from the site either via the M1 or A/B roads.</p> <p>The site is serviced by its own railway station, East Midlands Parkway, which provides regular train services to Nottingham, London and Leicester and less regular services to Lincoln, Sheffield, Leeds and Derby. Buses to Kegworth and Clifton also service the site from East Midlands Parkway station, but services are infrequent. East Midlands Airport is approximately 9km to the south west.</p> <p>Furthermore, new plans are being put forward to the Government for three tram extensions, new train lines and stations and better transport connections in the region. This includes a tram extension from Long Eaton to Ratcliffe Power Station and the employment hub at East Midlands Gateway.</p>	Average
Compatibility of Adjoining Uses	The northern portion of the site is bordered by the East Midland Railway to the West with greenfield land and the River Soar beyond, greenfield land	Very Good

(including amenity impacts experienced by current/future occupiers and neighbouring areas)	<p>and the River Trent to the north, and the A453 to the south and east.</p> <p>The southern portion of the site is bound by the A453 to the north, West Leake Lane to the east, greenfield land to the south and Kegworth Road to the west.</p>	
<p>Developmental and Environmental Constraints (e.g. size; topography; site access; roads, lighting, landscaping, mains utilities and communications infrastructure; flood risk; contamination; nature and heritage conservation)</p>	<p>This is a large relatively level site occupied by a Power Station. There are multiple road access points into the site and a direct rail link into the site. Utilities and communications infrastructure are in place and there are substations, turbines, chemical storage and a range of buildings associated with the power station use onsite.</p> <p>There is potential for contamination across the site from the current use and in the areas of pulverised fuel ash. Asbestos is present in areas of the main plant. The site is a Lower tier Control of Major Accident Hazards (COMAH) site.</p> <p>There is a scheduled monument within the northern portion and adjacent to the site – Roman site on Red Hill (ref. 1003667).</p> <p>Kingston Park Pleasure Gardens is approximately 400m south of the site. There are a number of listed buildings within close proximity of the site in Kingston on Soar, Ratcliffe on Soar and Thrumpton. There are two listed buildings immediately adjacent to the site - Redhill Tunnel South Portals (West SPC6 28 and East SPC6 28a) (ref. 1417715) and Redhill Tunnel North Portal (ref. 1260025).</p> <p>Lockington Marshes SSSI is approximately 550m west of the site. The site is also within the Green Belt.</p> <p>The majority of the site is within Flood Zone 1 and therefore at a low risk of flooding with the exception of a small area immediately adjacent to the River Trent within Flood Zone 3 and an area within Flood Zone 2 near the main site entrance. There are areas of surface water within the site and a storage basin and channels within the southern portion of the site.</p>	Poor
<p>Barriers to Delivery and Mitigation (including ownership constraints - if known)</p>	<p>The site is in full ownership by Uniper Energy. Different areas of the site will be available at different times, the southern site and areas of the northern site will be available prior to the decommissioning of the plant.</p>	Average

<p>Market Attractiveness (including appropriateness, vacancy and market activity on site for the type of development proposed)</p>	<p>This is a highly accessible site in an attractive location and with unique features which make it attractive for low-carbon technology and energy related industries – such as a Gigafactory or hydrogen distribution, advanced manufacturing, science park and research and development uses.</p>	<p>Very Good</p>
<p>Strategic Fit with Growth Area Objectives (by target Market Segment)</p>	<p>This is a key employment site for the region and in a growth corridor near the M1 and East Midlands Airport as well as the HS2 Toton Hub. There are proposals for transforming the site into ZERO, a global research centre that will develop real-world low-emission technologies, which open up new business markets and help the UK hit its climate change targets. The site has also recently been designated as part of the East Midlands Airport Freeport by the Government.</p>	<p>Very Good</p>
<p>OVERALL SITE RATING</p>	<p>Good</p>	
<p>Recommendation and Potential Future Uses</p>	<p>Allocate for employment uses – the site is suitable for Research & Development uses located adjacent to the East Midlands Parkway Railway Station, Science Park and Advanced Manufacturing uses on the site south of the A453 and more energy-intensive low-carbon technology industries on the site north of the A453.</p> <p>It is part of the East Midlands Airport Freeport, one of 8 designated by the Government in its March 2021 Budget with the aim of reducing administrative burdens and tariff controls, provide relief from duties and import taxes, and ease tax and planning regulations.</p>	
<p>SITE SUMMARY:</p>		
<p>This site is occupied by the Uniper Energy Ratcliffe-on-Soar Coal-Fired Power Station. However, the site is now operating in more of a reserve capacity and it is due to be decommissioned in 2025. A representative of Uniper Ratcliffe Redevelopment advised that Uniper are working with the East Midlands Development Corporation on proposals for transforming the site into ZERO, a global research centre that will develop real-world low-emission technologies. Areas of the site can be brought forward ahead of the decommissioning of the main site including the southern ash fields site and areas within the northern site. It is understood that the site south of the A453 comprising of approximately 106 ha of land in use for ash recovery is available now.</p> <p>Areas within the main site north of the A453 are able to come forward prior to the decommissioning of the main plant in 2025. A planning application (ref. ES/4154) has been submitted to Nottinghamshire County Council for the redevelopment of the north-eastern corner of the site (currently in use as carparking) for the East Midlands Energy Re-Generation (EMERGE) Centre which would generate energy from domestic and commercial waste leftover from recycling. The rail link and national grid substations would be retained in any future redevelopment of the site.</p> <p>Other nearby East Midlands Development Corporation projects include creating an inland freeport at East Midlands Airport and the Toton HS2 hub station and development of a new</p>		

community and innovation district around this. Furthermore, new plans are being put forward to the Government for three tram extensions, new train lines and stations and better transport connections in the region. This includes a tram extension from Long Eaton to Ratcliffe Power Station and the employment hub at East Midlands Gateway.

The site is part of the East Midlands Airport FreePort, one of 8 designated by the Government in its March 2021 Budget with the aim of reducing administrative burdens and tariff controls, provide relief from duties and import taxes, and ease tax and planning regulations

This is an important employment site for the region and key employer with significant potential for redevelopment for zero-carbon technology, advanced manufacturing and Research and Development uses as the site is de-commissioned. It is recommended that it the site is allocated for employment uses.

East of Gamston (Ref: RBC5)



**GROSS SITE AREA:
24.66 ha**

**ESTIMATED NET DEVELOPABLE
AREA:
12 ha**

(Note: Out of the total 20 ha proposed employment land across the larger site, 8 ha is already developed towards the airport (4 ha for storage and 4 ha for alternative use). The policy situation therefore is that there is 20 ha of employment land, with 12 ha remaining)

CRITERIA	COMMENT	RATING
<p>Site Context</p> <ul style="list-style-type: none"> • Location with regards to existing employment areas and other sites • How the site fits into the overall portfolio 	<p>The appraisal site comprises of a larger greenfield site to the east adjacent to the A52 and a smaller brownfield site adjacent to Tollerton Lane and Nottingham City Airport. The site is east of Gamston and Edwalton – southern suburbs of Nottingham.</p> <p>The site is within a wider strategic allocation ‘East of Gamston, North of Tollerton Lane’. A planning application for the first phase (outside the appraisal site boundary) was submitted in December 2020. The application includes a land use plan for the wider strategic site which identified the western site for employment uses as well as land adjacent to the eastern site.</p> <p>The site is approximately 1.5 km north east of the Strategic Allocation at Melton Road, Edwalton (Local Plan Part 1, Policy 20) which is identified for around 1,500 dwellings, up to 4 hectares of B1 and/or employment generating development, a neighbourhood centre and other community facilities.</p>	
<p>Local Plan Designation</p>	<p>The development plan for Rushcliffe consists of the Local Plan Part 1: Core Strategy (Adopted December 2014), Adopted Policies Map and the Local Plan Part 2: Land and Planning Policies (Adopted October 2019).</p> <p>The site is identified in the policy map as being within a strategic allocation (LP1 Policy 20-25). Local Plan Part 1, Policy 25 Strategic Allocation East of Gamston / North of Tollerton identifies the site as a strategic allocation for mixed-use development including around 2,500 dwellings up to 2028, up to a further 1,500 homes post 2028, around 20 hectares of employment development, a neighbourhood centre and other</p>	

	<p>community facilities as appropriate as well as improvements to the A52.</p> <p>The illustrative layout shows employment and enhanced green infrastructure on the western site and housing on the eastern site.</p> <p>Out of the total 20 ha proposed employment land, 8 ha is already developed towards the airport (4 ha for storage and 4 ha for alternative use). The policy situation therefore is that there is 20 ha of employment land, with 12 ha remaining.</p>
<p>Status in SHLAA</p>	<p>The Strategic Housing Land Availability Assessment Report 2019 (January 2020) identified the wider strategic site East of Gamston / North of Tollerton as a strategic allocation for mixed-use development including around 4000 Dwellings and other uses. The area of land being promoted by willing landowners is considered to be suitable now, available now and an element is achievable.</p>
<p>Planning History</p>	<p>Recent planning applications include;</p> <ul style="list-style-type: none"> • 20/01244/SCOEIA - Request for scoping request for proposed development on Land East of Gamston and North of Tollerton Granted subject to conditions 15.07.2020 This application relates to land to the east and north of the site. • 20/03244/OUT - Outline Planning Application for the first phases of a Sustainable Urban Extension at Land East of Gamston and North of Tollerton, comprising up to 2,250 dwellings, a primary school, a local centre (Class E a, b, c, d, e, f and g) and hot food takeaway (sui generis), strategic green infrastructure and associated buildings, childrens play areas, strategic infrastructure including drainage and engineering and demolition works. Full details sought for the principal vehicular accesses off A52 and Tollerton Lane with all other matters reserved. Pending – Validated 22.12.2020 This application relates to land to the east and north of the site. The outline application is accompanied by an overall masterplan for the site. The Land Use Plan for Allocation shows the employment site to the east retained with additional employment adjacent to the north and south. It shows the site to the west accommodating 12.7 ha of employment with a new junction from the A52 at the northern boundary and surface water attenuation ponds/green space in the eastern portion of the site. • 15/02335/FUL – Full planning application - Demolition of existing buildings and erection of a manufacturing and storage and distribution unit (B2/B8) with ancillary office floorspace together with associated infrastructure

	<p>including service yard, car parking and landscaping – Granted 29.01.2016 This application relates to the eastern site and has been implemented.</p>	
Current Use and Land Type	The appraisal site comprises of a greenfield site in agricultural use to the west adjacent to the A52 and a brownfield site to the east adjacent to Tollerton Lane accommodating modern industrial units.	
Occupier Profile (if partly developed, including % of available land and levels of vacancy onsite)	The western site is a greenfield site in agricultural use. The eastern site is occupied by Monarch Furniture (manufacturing), Lapcabby (IT storage) and Arcus Helicopters.	
Strategic Road Access	<p>The site is adjacent to the A52; however, there is presently no existing access to the site from the A52. The A52 is a good free-flowing road which, from the site, leads directly onto junction 25 of the M1 in a Westerly direction and onto the A46 in a North Easterly direction.</p> <p>Access improvements to the A52 would be required as part of the delivery of the strategic allocation.</p>	Average
Local Road Access	<p>The western site is currently undeveloped and there is no direct road access onto the site. Farm track access to the western site is via Tollerton Lane. The eastern site can be accessed from Tollerton Lane. Tollerton Lane converges with the A52 to the north and A606 to the south.</p> <p>The strategic allocation includes provision for a new access to the site from the A52.</p>	Average
Proximity to Urban Areas and Access to Labour and Services (including public transport / cycling / walking accessibility)	<p>The site is adjacent to the main urban area and Gamston District Centre, albeit the sites are not easily accessible from these areas. To the East, the site is separated from the residential village of Edwalton and District Centre of Gamston by the A52. Edwalton provides schools and local shops and merges with the village of Gamston to the North and larger residential village of West Bridgford to the North/West – both of these villages provide additional services such as medical centres and supermarkets.</p> <p>There are no bus stops servicing the A52, the nearest bus stop to the site is 0.8km North off the A52 on Ambleside which provides regular services to the City of Nottingham and less regular services to West Bridgford and Gamston. Bus stops on the opposite side of Ambleside provide regular services to Clifton and Cropwell Bishop and less regular services to Hickling and West Bridgford.</p>	Poor

	<p>There are bus stops on Tollerton Lane adjacent to the eastern site with regular services between Cropwell Bishop and Nottingham. There is also a shop link service between Gamston Morrisons and Keyworth.</p> <p>The sites are difficult to access from the adjacent residential areas via walking and new sustainable transport and facilities would need to be provided as part of the wider development.</p>	
<p>Compatibility of Adjoining Uses (including amenity impacts experienced by current/future occupiers and neighbouring areas)</p>	<p>The eastern site is bordered to the north by the Spire Nottingham Hospital, to the east by Nottingham City Airport, to the south by greenfield land and to the west by Tollerton Lane.</p> <p>The western site is bordered to the north, east and south by greenfield land and to the west by the A52 with a golf course (Safeguarded Land LP1 Policy 4), residential (with a buffer in between) and the District Centre of Gamston and Edwalton beyond.</p>	Good
<p>Developmental and Environmental Constraints (e.g. size; topography; site access; roads, lighting, landscaping, mains utilities and communications infrastructure; flood risk; contamination; nature and heritage conservation)</p>	<p>The majority of site is greenfield, consequently there are the usual biodiversity considerations. There are a series of Grade II Listed pillboxes around Nottingham airport, their setting and interrelationship with the land is an important consideration.</p> <p>However, these are away from the west of the site, where the remaining employment element will be concentrated. The site is within Flood Zone 1 and therefore at low risk of flooding. The western site is a large and level site. The Meadow Covert Local Nature Reserve is approximately 350m west of the western site. There are hedgerows within the site.</p>	Very Good
<p>Barriers to Delivery and Mitigation (including ownership constraints - if known)</p>	<p>Infrastructure requirements for the site have been considered through the Local Plan Part 2: Infrastructure Delivery Plan (May 2018). New accesses on the A52 are required to deliver the wider allocation.</p>	Good
<p>Market Attractiveness (including appropriateness, vacancy and market activity on site for the type of development proposed)</p>	<p>The sites are in an attractive location adjacent to the main urban area, Gamston District Centre, Nottingham City Airport and the A52. It is considered that they would be appropriate for employment use as part of the wider strategic allocation.</p>	Good
<p>Strategic Fit with Growth Area Objectives (by target Market Segment)</p>	<p>This site is adjacent to Gamston district centre and has the potential to accommodate key industrial growth sectors as identified in the D2N2 Vision 2030 document.</p>	Average

OVERALL SITE RATING	Good	
Recommendation and Potential Future Uses	<p>Allocate for employment uses</p> <p>Retain current Local Plan Part 1 strategic allocation to protect proposed employment space.</p>	
SITE SUMMARY:		
<p>The site comprises of a larger greenfield site in agricultural use to the west adjacent to the A52 and a smaller brownfield site accommodating modern industrial units to the east adjacent to Tollerton Lane. The eastern site is adjacent to Nottingham City Airport. The western site is adjacent to the main urban area and district centre of Gamston, although is not easily accessible from here. The site is within a wider strategic allocation 'East of Gamston, North of Tollerton Lane'.</p> <p>A planning application for the first phase (outside the appraisal site boundary) was submitted in December 2020. The application includes a land use plan for the wider strategic site which identified the western site for employment uses as well as land adjacent to the eastern site, a new access to the site from the A52 is also proposed.</p> <p>It is recommended that the site be allocated for employment uses and the current Local Plan Part 1 strategic allocation is retained to protect the proposed employment space.</p>		

Land south of Clifton (Ref: RBC6)



**GROSS SITE AREA:
25.88 ha**

**ESTIMATED NET DEVELOPABLE
AREA:
20 ha**

CRITERIA	COMMENT	RATING
<p>Site Context</p> <ul style="list-style-type: none"> • Location with regards to existing employment areas and other sites • How the site fits into the overall portfolio 	<p>This is a large greenfield site to the south of Clifton, a south western suburb of Nottingham. It is adjacent to the Clifton South Tram Stop. The site is within a wider strategic allocation 'South of Clifton'.</p> <p>Outline planning permission was granted in May 2019 for the wider site and includes up to 20 ha of employment land incorporating a maximum of 100,000sqm of floorspace adjacent to the A453. The Illustrative Development Framework Plan shows the appraisal site as being identified for 20ha of employment land as well as well as a new access road running broadly parallel to the A453 from north to south and connecting with the wider development to the east. A reserved matters application (ref. 21/00314/REM) for the first employment unit has been received. The wider strategic allocation site incorporates land safeguarded for potential future extension of the tram route. The development is known as 'Fairham Pastures'.</p>	
<p>Local Plan Designation</p>	<p>The development plan for Rushcliffe consists of the Local Plan Part 1: Core Strategy (Adopted December 2014), Adopted Policies Map and the Local Plan Part 2: Land and Planning Policies (Adopted October 2019).</p> <p>The site is identified in the policy map as being within a strategic allocation (LP1 Policy 20-25). Local Plan Part 1, Policy 24 Strategic Allocation South of Clifton identifies the site for mixed-use development of around 3,000 dwellings, around 20 hectares of employment development, a neighbourhood centre and other community facilities as appropriate, all of which will be constructed within the plan period to 2028.</p> <p>The development shall be appropriately phased to take into account improvements to the A453(T) and completion of the NET extension to Clifton with a safeguarded route to allow for the possible future extension of the NET through the site and further to the south.</p>	

<p>Status in SHLAA</p>	<p>The Strategic Housing Land Availability Assessment Report 2019 (January 2020) identified the wider strategic site 'South of Clifton (SHLAA ref. SHLAA/BIF/003) comprising of 176 ha with a capacity of up to 3000 dwellings. The area of land being promoted by willing landowners is considered to be suitable now, available now and a small element is achievable.</p>
<p>Planning History</p>	<p>Recent planning applications include:</p> <ul style="list-style-type: none"> • 14/01417/OUT – Outline planning application – Outline application for the development of a sustainable urban extension comprising residential development up to a maximum of 3000 dwellings, employment development incorporating a maximum of 100,000sqm of B1, B2 & B8 floorspace, retail development (A1 to A5) up to a maximum of 2500sqm of floorspace, community buildings, leisure uses, schools, gypsy & traveller pitches, access to the site, new roads, footpaths & cycleways, green infrastructure including new community park, ancillary infrastructure & groundworks – Granted 24.05.2019 <p>The Illustrative Development Framework Plan shows the appraisal site as being identified for 20ha of employment land as well as well as a new access road running broadly parallel to the A453 from north to south and connecting with the wider development to the east.</p> <ul style="list-style-type: none"> • 19/02061/REM – Reserved matters application - Reserved matters application for outline permission 14/01417/OUT to seek approval of the access, appearance, landscaping, layout and scale for the development of the link road, as well as drainage and earthworks for the entire site – Granted 12.12.2019 • 20/00584/REM – Reserved matters application - Reserved matters application for outline permission 14/01417/OUT to seek approval of the access, appearance, landscaping, layout and scale for the development of the second phase of the highway infrastructure as well as detailed drainage information for that section of infrastructure – Granted 18.06.2020 • 20/00706/REM – Reserved matters application - Reserved matters application for outline permission 14/01417/OUT to seek approval of the access, appearance, landscaping, layout and scale for the provision of the infrastructure to serve the commercial land, which includes detailed highway design for the access road, earthworks strategy and drainage strategy for this section of infrastructure – Granted 05.11.2020 This application relates to land within the boundary of the appraisal site.

	<ul style="list-style-type: none"> • 20/01463/REM – Reserved matters application - Reserved matters application pursuant to outline permission 14/01417/OUT to seek approval of the access, appearance, landscaping, layout and scale for the primary electrical substation for the site. – Granted 19.11.2020 • 20/01857/NMA – Non-material amendment - Application for a non-material amendment to planning permission 14/01417/OUT to amend Condition 28 from pre-commencement of development to pre-occupation of residential dwellings and for point iv) to be reassessed – Granted 08.09.2020 • 21/00314/REM - Reserved matters application pursuant to outline permission 14/01417/OUT to seek approval of the access, appearance, landscaping, layout and scale of the first plot of the Commercial Area, referred to as Plot B3 and for temporary access Arrangements – Validated 01.02.2021 	
Current Use and Land Type	This site comprises of greenfield land in agricultural use.	
Occupier Profile (if partly developed, including % of available land and levels of vacancy onsite)	N/A	
Strategic Road Access	The site adjoins the A453 Remembrance Way. Junction 24 of the M1 is c. 8 km south west of the site. The A453 (Remembrance Way) is a good, free-moving road which leads directly from the site onto junction 24 of the M1 in a South Westerly direction. The A453 also joins the A52 (Clifton Boulevard) after 5 km in a North Easterly direction.	Average
Local Road Access	<p>Access into the site via the north is off the access road to the Clifton South Tram Park and Ride from the Mill Hill Roundabout.</p> <p>Access into the site via the south is taken via a farm track from Barton Lane. Barton Lane converges with Green Street to the east and Nottingham Road to the west. Green Street joins the A453 at the Mill Hill Roundabout. Barton Lane is height-restricted by a bridge (the A453 which travels over the road, height unknown) just outside the perimeter of the site. Furthermore, the section of Barton Lane under the bridge is not part of the highway and is private.</p>	Average
Proximity to Urban Areas and Access to Labour and Services	The site is situated on the southern outskirts of the of Clifton (within the south western suburbs of	Good

(including public transport / cycling / walking accessibility)	<p>Nottingham) which provides schools, a library, police station, a range of shops and a supermarket.</p> <p>The site is well-serviced by public transport – a tram service travels from the Clifton South Park and Ride to the north of the site through the centre of Clifton and on to Nottingham city centre, approximately 8.5km away. The 901 bus service stops at Clifton South Park and Ride and serves Sutton Bonington Campus, Nottingham Trent University and University Park.</p>	
Compatibility of Adjoining Uses (including amenity impacts experienced by current/future occupiers and neighbouring areas)	The site is bordered to the West by the A453, by greenfield land to the South and East and by the Clifton Park and Ride/Clifton South tram stop to the North.	Very Good
Developmental and Environmental Constraints (e.g. size; topography; site access; roads, lighting, landscaping, mains utilities and communications infrastructure; flood risk; contamination; nature and heritage conservation)	<p>This is a large, gently sloping site. The site is within Flood Zone 1 and therefore at low risk of flooding. There are no environmental or heritage designations within or adjacent to the site.</p> <p>With regards environmental constraints, the application and subsequent reserved matters are supported by relevant technical information and proposals for mitigation.</p>	Very Good
Barriers to Delivery and Mitigation (including ownership constraints - if known)	Infrastructure requirements for the site have been considered through the Local Plan Part 2: Infrastructure Delivery Plan (May 2018) and subsequent planning application. The site is being progressed in partnership with Homes England who own part of the site.	Good
Market Attractiveness (including appropriateness, vacancy and market activity on site for the type of development proposed)	The site is in an attractive location adjacent to the main urban area - Clifton, the A453 and Clifton South Tram Stop and Park and Ride. It is considered that it would be appropriate for employment use as part of the wider strategic allocation.	Very Good
Strategic Fit with Growth Area Objectives (by target Market Segment)	This site is adjacent to Clifton and has the potential to accommodate key industrial growth sectors as identified in the D2N2 Vision 2030 document.	Average
OVERALL SITE RATING	Good	

Recommendation and Potential Future Uses	Allocate for employment uses Retain current Local Plan Part 1 strategic allocation to protect proposed employment space
---	---

SITE SUMMARY:

This is a large greenfield site to the south of Clifton, a south western suburb of Nottingham. It is adjacent to the Clifton South Tram Stop. The site is within a wider strategic allocation 'South of Clifton'. Outline planning permission was granted in May 2019 for the wider site and includes up to 20 ha of employment land incorporating a maximum of 100,000 sqm of floorspace adjacent to the A453.

The Illustrative Development Framework Plan shows the appraisal site as being identified for 20ha of employment land as well as well as a new access road running broadly parallel to the A453 from north to south and connecting with the wider development to the east. Reserved matters permission was granted in November 2020 for the provision of the infrastructure to serve the commercial land. A reserved matters application (ref. 21/00314/REM) for the first employment unit has been received. The wider strategic allocation site incorporates land safeguarded for potential future extension of the tram route.

It is recommended that the site be allocated for employment uses and the current Local Plan Part 1 strategic allocation is retained to protect the proposed employment space.

Moorbridge Industrial Estate (Ref:) RBC7



**GROSS SITE AREA:
12.25 ha**

**ESTIMATED NET DEVELOPABLE
AREA:
0 ha**

CRITERIA

COMMENT

RATING

Site Context

- Location with regards to existing employment areas and other sites
- How the site fits into the overall portfolio

This is a successful and established industrial estate on the northern periphery of Bingham. The 'Land North of Bingham' sustainable urban extension wraps around this site and comprises of up to 1,050 residential dwellings and 15.6 hectares of employment development (ref. 10/01962/OUT).

The residential development is coming forward and the outline planning permission made provision for employment development adjacent to the A46, approximately 700m to the west of this site. This is a later phase of the development and has not been brought forward yet.

Local Plan Designation

The development plan for Rushcliffe consists of the Local Plan Part 1: Core Strategy (Adopted December 2014), Adopted Policies Map and the Local Plan Part 2: Land and Planning Policies (Adopted October 2019). The site is included within the Bingham Neighbourhood Plan Area map but a draft plan has not yet been produced.

The eastern portion of the site (to the south of Moorbridge Road East) is identified in the policy map as being within a strategic allocation (LP1 Policy 20-25), this area also includes the new residential development 'Roman Quarter' to the north and land to the west. Local Plan Policy 21 Strategic Allocation at Land North of Bingham identifies the land as a strategic site for around 1000 dwellings, around 15.5 ha of B1, B2 and B8 employment uses, a neighbourhood centre and other appropriate community facilities.

	<p>It sets out that the employment uses should be concentrated adjacent to the west of the site in proximity to the A46 and the existing employment (at the Moorbridge Industrial Estate) to the east should be retained. Car Dyke Flood Management scheme is identified to the north/east with land identified for new residential development to the north. The area in the east of the estate to the south of Moorbridge Road East is identified for E (office), B2 and B8 employment uses.</p> <p>There are also two sites allocated for employment (Policy 15): Chapel Lane East (to the south of Moorbridge Road and east of Chapel Lane) and Chapel Lane West (to the west of Chapel Lane between the Lidl store to the south and Ranch House - Vehicle Servicing to the north). Chapel Lane East was incorporated in the Lidl supermarket scheme (ref. 14/02429/FUL) and the wooded area to the north of the car park remains. Chapel Lane West is incorporated within the site for the new leisure centre (ref. 19/02914/FUL).</p>
<p>Status in SHLAA</p>	<p>The SHLAA Report 2019 (January 2020) identified the wider strategic site 'Land north of Bingham' (SHLAA ref. SHLAA/BIN/015) as being available, suitable and achievable now - delivery commenced in 2018. A small area in the east of the industrial estate off Moorbridge Road East is included within this SHLAA site boundary.</p> <p>SHLAA site 'Land off Chapel Lane (north of the railway) (ref. SHLAA/BIN/001) wraps around the site to the north and east, beyond the land falling within SHLAA/BIN/015. It comprises of 122 ha with an estimated capacity of 2400 and was submitted by the landowner/developer. It has no allocation or extant permission.</p>
<p>Planning History</p>	<p>Recent planning history includes:</p> <ul style="list-style-type: none"> • On the vacant site to the south of Moorbridge Road and east of Chapel Lane (site area of 1.28 ha): 19/02914/FUL – Full planning application - Construction of new leisure centre with swimming pool and fitness suite, new community hall sharing entrance and common facilities with the leisure building, new separate office building, and new car park to serve these buildings – Granted 29.04.2020 – this is being implemented. (Several discharge of conditions applications have also been submitted and are pending consideration) • On the vacant site to the south of Moorbridge Road East (site area of 1.33 ha): 18/01750/FUL – Full application - Construction of 34 no. industrial units with associated car parking and new access road – Granted 31.05.2019 – 23 of these units are now under construction.

	<p>(Several discharge of conditions applications have also been submitted with some awaiting a decision, a non-material amendment has also been approved to allow an alteration in size of Units 13 and 14, repositioning of doors to plots 13, 14 and 15, repositioning of fire escapes to units 32 and 33 and external elevation changes to units 31, 32 and 33, ref. 19/02115/NMA). The new Central Source building site is adjacent to this site to the east.</p> <ul style="list-style-type: none"> On the Central Source site to the east of the site: <ul style="list-style-type: none"> 20/03086/FUL - New build warehouse unit including mezzanine level and ancillary accommodation. Flexible use B1(a), B2 & B8 at Miller House Moorbridge Road East – Submitted 16.12.2020, pending determination 20/03088/FUL - Extension to existing industrial unit. Flexible use B2 & B8 at Miller House Moorbridge Road East – Submitted 09.12.2020, pending determination. Construction is advanced on this site.
Current Use and Land Type	This is a brownfield site occupied by an established industrial estate.
Occupier Profile (if partly developed, including % of available land and levels of vacancy onsite)	<p>This is an established industrial estate occupied by B class employment uses together with sui generis (garages, car part fitting etc). Occupiers include:</p> <ul style="list-style-type: none"> Minster Veterinary Centre Screwfix Inflatable World TLA Electrical Distributors Focus Label Machinery (printing manufacturer) Ranch House Service and MOT MG Safety (wholesale PPE) Streetwise Environmental Waste Management DJL Pet Food Ingredients Central Source (industrial catalogue supplier) Farrell Transport (distribution and warehousing) <p>There are a number of smaller workshops located in Moorbridge Court.</p> <p>The units appeared to be fully occupied during the time of the site visit (November 2020).</p>
Strategic Road Access	<p>There is a junction within 2km of the site which connect the site's access road (Chapel Lane) to the A46.</p> <p style="text-align: right;">Very Poor</p>

<p>Local Road Access</p>	<p>The site is accessed from the north via Chapel Lane, a good free-moving road which joins the A46 approximately 2km from the site.</p> <p>The site can be accessed from the south via the A52, however, this route is constrained as it travels through residential areas of Bingham with various speed restrictions, past a school and through a level crossing at the South of the site at the Kirkhill/Chapel Lane junction.</p>	<p>Average</p>
<p>Proximity to Urban Areas and Access to Labour and Services (including public transport / cycling / walking accessibility)</p>	<p>The site is situated to the north of Bingham which provides schools, a medical centre, shops and a leisure centre.</p> <p>From the site, a pedestrian footpath crosses the railway line to the south and provides direct access to Bingham. Bingham railway station is approximately 600m south of the site and provides regular train services to Nottingham and Grantham. There are bus stops adjacent to the site on Chapel Lane with regular bus services to Newark on Trent and East Bridgford.</p>	<p>Good</p>
<p>Compatibility of Adjoining Uses (including amenity impacts experienced by current/future occupiers and neighbouring areas)</p>	<p>The site is bordered by the East Midlands Railway line to the south with the town of Bingham beyond, and greenfield land to the north, east and west. A supermarket also adjoins the site to the South West along with recreational fields to the South East.</p>	<p>Average</p>
<p>Developmental and Environmental Constraints (e.g. size; topography; site access; roads, lighting, landscaping, mains utilities and communications infrastructure; flood risk; contamination; nature and heritage conservation)</p>	<p>This is a large, relatively level, site. It is an established industrial estate with utilities and communications infrastructure in place. The site is within Flood Zone 1 and therefore at a low risk of flooding; however, there is an area of high flood risk (Flood Zone 3) immediately to the north and east.</p> <p>There is also a high potential of archaeology findings on the site and a scheduled monument is also located within the site boundary - Henge 850m south east of Foss Road Farm (ref. 1016777). There are also a number of Listed Buildings in Bingham approximately 200m to the south of the site.</p>	<p>Average / Poor</p>
<p>Barriers to Delivery and Mitigation (including ownership constraints - if known)</p>	<p>The site is fully developed apart from two sites to the south of Moorbridge Road and to the south of Moorbridge Road East which both have extant planning permissions.</p> <p>The site has multiple landowners across the whole industrial estate, including the Borough Council</p>	<p>Average / Poor</p>

	on the land near the railway. There is a scheduled ancient monument within the site and listed buildings within 200m of the site, there is also an area of high flood risk immediately north and east of the site.	
Market Attractiveness (including appropriateness, vacancy and market activity on site for the type of development proposed)	<p>This is an established and popular industrial estate with low vacancy levels. Demand is expected to be local / sub-regional as opposed to anything on a more national scale but take up has historically been good.</p> <p>Permission was granted in 2019 for a further 34 industrial units (23 are under construction) on the site whilst permission was granted in 2020 for a new leisure centre and offices within the southern portion of the site. It is adjacent to the wider sustainable urban extension 'Land North of Bingham'.</p>	Good
Strategic Fit with Growth Area Objectives (by target Market Segment)	<p>This site already accommodates key industrial growth sectors as identified in the D2N2 Vision 2030 document and has the potential to accommodate additional businesses within these sectors. Key sectors already accommodated on the site include:</p> <ul style="list-style-type: none"> • Construction • Logistics & E-Commerce • Transport Equipment Manufacturing • Food & Drink Manufacturing • Health/Social Care • Professional/Business 	Good
OVERALL SITE RATING	Average / Good	
Recommendation and Potential Future Uses	<p>Protect for employment uses</p> <p>Retain current Local Plan Part 1 Strategic Allocation 'Land North of Bingham' Designation in the eastern portion of the site and protect the remainder of the site for employment uses</p>	
SITE SUMMARY:		
<p>This is a successful, established industrial estate on the northern periphery of Bingham. The 'Land North of Bingham' sustainable urban extension wraps around this site and the residential development is coming forward. Within this allocation, outline planning permission has been granted for employment development adjacent to the A46, to the west of this site.</p> <p>The site is occupied by a range of employment and sui generis uses. Two areas within the site have recent permissions for 34 industrial units (23 units are under construction) and for a new leisure centre. This is a popular industrial estate with low vacancy levels. The employment uses within the eastern portion of the site are protected in the Strategic Allocation and it is recommended that the remainder of the site be protected for employment uses.</p>		

British Gypsum (Ref: RBC8)



GROSS SITE AREA:
27.15 ha

ESTIMATED NET DEVELOPABLE AREA:
0 ha

CRITERIA	COMMENT	RATING
<p>Site Context</p> <ul style="list-style-type: none"> • Location with regards to existing employment areas and other sites • How the site fits into the overall portfolio 	<p>This site is occupied by the British Gypsum manufacturing plant, service centre, drywall training academy and head office. British Gypsum is the country's leading manufacturer and supplier of gypsum-based plastering solutions. The site has direct rail access from the adjacent Great Central Railway line. This is a key employment site for the district.</p>	
<p>Local Plan Designation</p>	<p>The development plan for Rushcliffe consists of the Local Plan Part 1: Core Strategy (Adopted December 2014), Adopted Policies Map and the Local Plan Part 2: Land and Planning Policies (Adopted October 2019).</p> <p>The site is not allocated. It is encircled by Green Belt to the north and west (LP1 Policy 4; LP2 Policy 21).</p> <p>The site is within the East Leake Neighbourhood Plan area and the plan was adopted in November 2015.</p>	
<p>Status in SHLAA</p>	<p>The site was not submitted to the SHLAA Report 2019 (January 2020).</p>	
<p>Planning History</p>	<p>Recent planning history is extensive and includes:</p> <ul style="list-style-type: none"> • 17/02688/FUL – Full planning application - Erection of 25m high exhaust stack to replace existing stack as part of an upgrade to a plasterboard dryer – Granted 03.01.2018 	

	<ul style="list-style-type: none"> • 16/03014/FUL – Full planning application – Erection of a store building – Granted 19.01.2017 • 16/02888/FUL – Full planning application – The erection of a gatehouse and alterations to the site’s access and egress – Granted 06.01.2017 • 16/01430/CMA – Periodic review of mineral permissions pursuant to Section 96 of Environment Act 1995 – No objection – Granted 15.07.2016 • 13/00096/FUL – Full planning application – Engineering works to stabilise and re-profile failed slope – Granted 19.02.2013 • 12/01841/FUL – Full planning application – Erection of new dust extraction facility to replace existing use on site in order to reduce emissions from existing factory department – Granted 11.12.2012 • 12/00208/FUL – Full planning application – Engineering works to stabilise and re-profile failed slope – Granted 08.05.2012 • 05/01708/FUL – Full planning application – Front extension to reception/waiting area – Granted 03.02.2006 • 04/00844/FUL – Full planning application – Use of land for storage of desulphogypsum and form carpark for adjacent Great Central Railway site – Refused 15.07.2004 • 03/01481/FUL – Full planning application - Construct 46m high chimney for plasterboard manufacturing – Granted 16.12.2003 • 03/00086/FUL – Full planning application – Extensions to warehouse, workshop, storage buildings to permit expansion of plasterboard manufacturing capacity - Granted 15.10.2003
Current Use and Land Type	This is a brownfield site occupied by a manufacturing plant and office buildings.
Occupier Profile (if partly developed, including % of available land and levels of vacancy onsite)	This site is occupied by the British Gypsum plasterboard manufacturing plant, service centre, head office and drywall training academy. Weatherford wireline services also occupy the site.
Strategic Road Access	<p>The site is 3.5 km west of the A60 and 7.7km east of the A453. Junction 24 of the M1 is approximately 12.3km from the site via the A453.</p> <p style="text-align: right;">Very Poor</p>
Local Road Access	<p>The site is accessed from the south via Gotham Road which is a semi-residential road constricted by speed restrictions/roundabouts. Gotham Road leads south to the centre of the village of East Leake.</p> <p>The site is also accessible for HGV’s from the north via Bunny Lane which joins Gotham</p> <p style="text-align: right;">Very Poor</p>

	<p>Road/Leake Road to the north. Bunny Lane is constricted by a height restricted railway bridge (max height 4.6m) 0.3km from the north entrance to the site.</p> <p>From the site, the A60 and A453 can be accessed via two-lane semi-rural roads.</p>	
<p>Proximity to Urban Areas and Access to Labour and Services (including public transport / cycling / walking accessibility)</p>	<p>The site is in a relatively rural location situated to the north of the residential village of East Leake which provides schools, a medical centre and local shops and amenities.</p> <p>Bus stops at the South entrance of the site provide regular bus services to Loughborough and East Leake centre heading south and Nottingham heading north.</p>	Average
<p>Compatibility of Adjoining Uses (including amenity impacts experienced by current/future occupiers and neighbouring areas)</p>	<p>The site is bordered by the Great Central Railway (Nottingham) heritage railway line to the East with greenfield land beyond, residential areas and greenfield land to the South and greenfield land to the North and East.</p>	Average
<p>Developmental and Environmental Constraints (e.g. size; topography; site access; roads, lighting, landscaping, mains utilities and communications infrastructure; flood risk; contamination; nature and heritage conservation)</p>	<p>This is large site which slopes from east to west down to Bunny Lane. It is an established manufacturing plant with utilities and communications infrastructure in place. The site is within Flood Zone 1 and therefore at a low risk of flooding.</p> <p>Rushcliffe Golf Course SSSI is approximately 500m west of the site. The site is bordered by the Great Central Railway (Nottingham) railway line to the East. There are no listed buildings or scheduled monuments within or adjacent to the site. Green Belt encircles the site to the north and west.</p>	Very Good
<p>Barriers to Delivery and Mitigation (including ownership constraints - if known)</p>	<p>The site is fully developed. It is understood that British Gypsums parent company, Saint Gobain own the whole site. The topography of the site, proximity to the railway line and SSSI may represent constraints to further expansion.</p>	Average
<p>Market Attractiveness (including appropriateness, vacancy and market activity on site for the type of development proposed)</p>	<p>This is a crucial employment site for the Borough, it accommodates the British Gypsum manufacturing plant, service centre, training academy and head office.</p> <p>However, it has poor local and strategic access.</p>	Good
<p>Strategic Fit with Growth Area Objectives (by target Market Segment)</p>	<p>This site already accommodates a key industrial growth sector – construction, as identified in the D2N2 Vision 2030 document.</p>	Good
<p>OVERALL SITE RATING</p>	<p>Average</p>	

<p>Recommendation and Potential Future Uses</p>	<p>Protect for employment uses</p>
<p>SITE SUMMARY:</p> <p>This site is occupied by the British Gypsum manufacturing plant, service centre, drywall training academy and head office as well as Weatherford wireline services. British Gypsum is the country's leading manufacturer and supplier of gypsum-based plastering solutions. This is a key employment site for the district.</p> <p>The site which slopes from east to west down to Bunny Lane. Rushcliffe Golf Course SSSI is approximately 500m west of the site and Green Belt encircles the site to the north and west. The site is bordered by the Great Central Railway (Nottingham) railway line to the East. Strategic and local access to the site is poor.</p> <p>The site is not designated in the Local Plan and given its importance it is recommended that it is protected for employment uses going forward.</p>	

British Geological Survey (Ref: RBC9)



**GROSS SITE AREA:
6.78 ha**

**ESTIMATED NET DEVELOPABLE
AREA:
0 ha**

CRITERIA	COMMENT	RATING
<p>Site Context</p> <ul style="list-style-type: none"> • Location with regards to existing employment areas and other sites • How the site fits into the overall portfolio 	<p>This site is occupied by the headquarters of the British Geological Survey (BGS) - a world-leading geological survey and global geoscience organisation, focused on science for government and research. This is a key employment site for the Borough.</p> <p>Our discussions with the BGS Estates team identified that there could be potential to extend the National Geological Repository located in the north of the site to the sports field adjacent to the west, subject to funding. The BGS also has ambitions to make the site carbon neutral and prior approval was recently granted for solar photovoltaics on the site.</p>	
<p>Local Plan Designation</p>	<p>The development plan for Rushcliffe consists of the Local Plan Part 1: Core Strategy (Adopted December 2014), Adopted Policies Map and the Local Plan Part 2: Land and Planning Policies (Adopted October 2019).</p> <p>The site is within the development boundary of Keyworth but is not allocated. Land immediately to the north-east of the site off Platt Lane is designated for employment (LP2 Policy 15) 'Platt Lane, Keyworth'. There are also housing allocations (LP2 Policy 2.1 - Policy 10) immediately north of the site – 'Land between Platt Lane and Station Road' and south of the site – 'Land off Nicker Hill'. They are both being brought forward for residential development, with housebuilders onsite.</p>	

	The site is within the Keyworth Neighbourhood Plan area and the plan was adopted in June 2018.
Status in SHLAA	The site was not submitted to the SHLAA Report 2019 (January 2020).
Planning History	<p>Recent planning history includes:</p> <ul style="list-style-type: none"> • 20/02647/PA14J - Application for prior approval for the installation of 623.35KWP Solar Photovoltaics array to the roof of buildings on site – Granted 21.12.2020 • 18/01937/FUL – Full planning application - Install 3m high wire mesh security fence – Granted 12.11.2018 • 16/00881/FUL – Full planning application – Purpose built single storey inspection bay and archive for geological samples – Granted 20.05.2016 • 09/01006/FUL – Full planning application – New computer suite (single storey building) and associated plant and plant building – Granted 17.07.2009 • 09/01000/FUL – Full planning application - Extension to geological sample core store (block N); associated landscaping; partial cladding of existing elevations of block N; dry cooler connection over the roof of Block N (between the computer suite (09/01006/FUL) and the core store) – Granted 11.06.2009 • 09/00958/FUL – Full planning application - Replacement of existing 12m high wind turbine with a 15m high wind turbine – Granted 17.07.2009 • 07/01723/FUL – Full planning application - Erect new 3 storey office building (following demolition of existing offices - revised scheme) – Granted 17.08.2007 • 07/00131/FUL – Full planning application - Erect new 3 storey office building (following demolition of existing offices) Blocks A-F – Granted 06.03.2007 • 06/01802/FUL – Full planning application - Erect wind turbine with 5m diameter rotor on 12m high tower – Granted 02.02.2007
Current Use and Land Type	This is a brownfield site occupied by a scientific research and development facility.
Occupier Profile (if partly developed, including % of available land and levels of vacancy onsite)	This site is occupied by The British Geological Survey - a world-leading geological survey and global geoscience organisation, focused on science for government and research. There are a range of buildings onsite including laboratories, extensive sample stores and archives, offices, staff facilities, conferencing facilities, visitor centre and parking. The National Geological Repository (NGR) is located on this site. There are multiple power generators onsite and gas storage facilities.

Strategic Road Access	The is approximately 1 km from the A606 Melton Road, and 6.8 km from the A46 via Nicker Hill and Platt Lane.	Poor
Local Road Access	The site is accessed from the south west via Nicker Hill and the goods entrance is accessed from the north via Platt Lane. The A606 (and subsequently the A46) can be accessed from Nicker Hill via Platt Lane. Platt Lane is a two-lane semi-rural road. Approaching the site from the village of Plumtree to the North, access is constricted by a restricted height railway bridge (max 4.4m) approximately 1.1km from the entrance to the site.	Average
Proximity to Urban Areas and Access to Labour and Services (including public transport / cycling / walking accessibility)	The site is situated to the east of the residential village of Keyworth which provides schools, a medical centre and local shops and amenities. Bus stops on Station Road, under 0.5km from the entrance to the site, provide regular bus services to Nottingham.	Average
Compatibility of Adjoining Uses (including amenity impacts experienced by current/future occupiers and neighbouring areas)	The site is bordered to the West/South by Nicker Hill and existing residential areas of the village of Keyworth beyond, greenfield land to the North, East and South East and some recreational land (Keyworth Skatepark) to the North. The sites immediately north and south of the site are both being brought forward for residential development, with housebuilders onsite.	Average
Developmental and Environmental Constraints (e.g. size; topography; site access; roads, lighting, landscaping, mains utilities and communications infrastructure; flood risk; contamination; nature and heritage conservation)	This is a smaller employment site with existing communications and utilities infrastructure and there are no topographical constraints. The site is within Flood Zone 1 and therefore at a low risk of flooding. There are no known environmental or historical constraints.	Very Good
Barriers to Delivery and Mitigation (including ownership constraints - if known)	The site is owned by the British Geological Survey (effectively the government). The site is fully developed and no barriers to delivery were identified from the site visit.	Very Good
Market Attractiveness (including appropriateness, vacancy and market activity on site for the type of development proposed)	This is an important employment site for the district, it accommodates The British Geological Survey research and development centre, archives, laboratories and visitor facilities.	Good

Strategic Fit with Growth Area Objectives (by target Market Segment)	This site already accommodates a key industrial growth sector – life sciences, as identified in the D2N2 Vision 2030 document.	Very Good
OVERALL SITE RATING	Good	
Recommendation and Potential Future Uses	Protect for employment uses	
SITE SUMMARY:		
<p>This site is occupied by The British Geological Survey - a world-leading geological survey and global geoscience organisation, focused on science for government and research. There are a range of buildings onsite including laboratories, extensive sample stores and archives, offices, staff facilities, conferencing facilities and visitor centre. This is a key employment site for the district.</p> <p>The site is fully developed and no barriers to delivery were identified from the site visit. The site is not designated in the Local Plan and it is recommended that it is protected for employment uses. The BGS Estates team identified that there could be potential to extend the National Geological Repository located in the north of the site to the sports field adjacent to the west, subject to funding and the Council may wish to consider pursuing this opportunity given the importance of the NGR's current facility and strategic fit with Growth Area Objectives.</p>		

Appendix 5 Strategic Site Assessment Criteria

The criteria for assessing strategic employment sites are set out below. These criteria relate to both the inherent value of a site and current conditions on it. Ownership and availability information has not been possible to obtain in many cases and a judgement may need to be made on these criteria.

Each site is given a rating of between 'very poor' and 'very good' against each criterion. No individual weightings would be attached to different criteria.

- 1. Site Context:** Location with regards to existing employment areas and other sites, how the site fits into the overall portfolio.
- 2. Local Plan Designation:** Allocation status in existing/emerging Local Plan and any other designations.
- 3. Status in SHLAA:** Commentary on whether the site was identified in the most recent SHLAA/HELAA.
- 4. Planning History:** Brief description of any relevant extant or recent planning permissions affecting the site. This would also pick up any current planning applications that have yet to be determined.

5. Current Use and Land Type: Commentary on existing land uses at the site, based on site observation.

6. Occupier Profile: Names and business types if partly developed, including % of available land and levels of vacancy onsite.

7. Access to strategic road network:

Very Good: adjoins junction of M1, A1, A50

Good: Within 1km of junction of M1, A1, A50

Average: Adjoins other Trunk roads (A6, A38, A46, A52, A60, A453, A606, A6097, A6191, A610, A614, A614, A617, A6514, A611, A608)

Poor: Within 1km of a trunk road

Very Poor: over 1km from an A road and/or through constrained/local roads, and/or through town centre or residential areas etc.

8. Local road access (including traffic congestion, quality of roads):

Very good local access: via free moving good roads avoiding residential areas/difficult junctions.

Very poor: difficult/narrow road access, via residential roads, difficult junction, congested roads.

NOTE: if the site is yet to be developed it is not unreasonable that local transport infrastructure has yet to be installed. If this is the case, and (for example) an extant planning permission makes provision for suitable transport infrastructure to be installed at a later date, this is reflected in the overall commentary and the final overall site rating (below).

9. Proximity to urban areas and ease of access to labour & services:

Very good: near City or District centre (i.e. within 1km); good pedestrian access to residential areas and public transport connections (i.e. on a regular bus route to residential areas and in close proximity to a bus/rail stop).

Very poor: remote site, no services or residential areas nearby (i.e. over 5km away) and very poor public transport accessibility.

10. Compatibility of adjoining uses: Amenity impacts experienced by occupiers (current or future) and neighbouring areas:

Very good: within larger employment area/ no incompatible surrounding land use.

Average: Use Class E business uses adjoining residential/other sensitive uses.

Very Poor: B2/B8 adjoining residential/other sensitive uses.

11. Developmental and Environmental Constraints: including size, topography, site access, roads, lighting, landscaping, mains utilities and communications infrastructure, flood risk, contamination, nature and heritage conservation etc.

Very good: generally level site, regular shape, over 3 ha in size; well served by good quality site infrastructure; no significant other constraints on development.

Very poor: sloping/uneven site; under 0.5 ha, irregular/narrow shape; lack of site infrastructure; other severe constraints (i.e. within HSE exclusion zone, flood zone 3b etc).

12. Barriers to Delivery and Mitigation: e.g. infrastructure required, groundworks and remediation, ownership constraints if available from the client team.

Very good: site available and in single ownership and limited infrastructure / mitigation required for delivery.

Very poor: site unavailable and/or in many small separate ownerships with risk of ransom strips, requires adjoining land to be developed first, abnormal infrastructure requirements contamination constraints, electricity pylons etc

13. Market Attractiveness: including appropriateness for industrial/commercial development, vacancy and market activity on site for the type of development proposed. Outcomes from discussions with Local Agents on wider market conditions in the local area e.g. levels of supply, changes in rents, length of time marketing sites, level of demand, types of demand etc.

Very good: viewed as attractive by agents/occupiers; area of strong demand for intended use; low vacancy levels; high profile location (i.e. visually adjoining a trunk road/key junction/beside a successful existing business park or industrial estate) etc. Market signals could include low supply, increasing rents, marketing times reducing, high demand.

Very poor: area of low demand; difficult to attract occupiers; high vacancy levels; low-profile location. Low demand market signals could include: high supply, decreasing rents, increasing marketing times, low demand.

14. Strategic Fit with Major Growth Area Objectives (by target Market Segment): distance to growth area/corridor and current contribution/potential to contribute to these growth aspirations.

Very good: located within or very close to a growth area, potential to accommodate key industrial sectors targeted by D2N2 and contributing to growth objectives.

Very poor: not located near growth area and unlikely to be in a position to attract companies operating in key industrial growth sectors.

OVERALL SITE RATING: Judgement based on a comprehensive assessment of the 14 key criteria. Sites to be ranked as good / average quality for protection including which 'high quality' or 'strategic sites' should continue to be or become safeguarded for employment (Class E and B) uses. Poorer quality sites will be identified for upgrading, or release to alternative uses. Sites can also be ranked in terms of deliverability.

Recommendation and Potential Future Uses: Identifies whether the site should be prioritised, safeguarded, retained for employment uses or considered for release. Recommendation of appropriate potential uses (cognisant of location requirements /preferences of key sectors).

Site Summary: Conclusions on the current situation and future prospects.

OTHER FACTORS TO BE NOTED FOR SITES WITH EXISTING DEVELOPMENT

Type of Use

- E/B2/B8, other

Vacancy Levels

- Estimate of proportion of vacant floorspace (recording agents' details on site lettings boards and following up with discussions on marketing activity)

Age of Premises

- Pre-1970
- 1970-1990
- 1990-2000
- Post 2000

Condition of Premises

- Good
- Average
- Poor
- Derelict/no longer in use

Amount of Development Land Available

- Under 10% of site undeveloped
- Over 50% of site undeveloped

Potential for Alternative Employment Use

- Good for bad neighbour or niche uses
 - Potential to sub-divide for starter units
 - Scope to upgrade for employment use
-

- Remove undesirable use

Appendix 6 SIC industries used in the Experian forecasts

The method used for re-categorising the employment forecasts by sector into E/B-Class uses is summarised below. This is based on the latest BRES 2019 SIC4 level data.

Apportionment of Employment Sectors to Land Uses – Broxtowe Borough

Experian Sector	Proportion of Jobs by Use Class				
	E(g)(i)/(ii)	E(g)(iii)	B2	B8	Other
Accommodation & Food Services	0%	0%	0%	0%	100%
Administrative & Supportive Services	11%	0%	0%	0%	89%
Agriculture, Forestry & Fishing	0%	0%	0%	0%	100%
Air & Water Transport	0%	0%	0%	0%	100%
Chemicals (manufacture of)	0%	0%	100%	0%	0%
Civil Engineering	0%	0%	0%	0%	100%
Computer & Electronic Products (manufacture of)	0%	84%	16%	0%	0%
Computing & Information Services	100%	0%	0%	0%	0%
Construction of Buildings	0%	0%	0%	0%	100%
Education	0%	0%	0%	0%	100%
Extraction & Mining	0%	0%	0%	0%	100%
Finance	100%	0%	0%	0%	0%
Food, Drink & Tobacco (manufacture of)	0%	0%	100%	0%	0%
Fuel Refining	0%	0%	0%	0%	0%
Health	0%	0%	0%	0%	100%
Insurance & Pensions	100%	0%	0%	0%	0%
Land Transport, Storage & Post	0%	0%	0%	93%	7%
Machinery & Equipment (manufacture of)	0%	0%	100%	0%	0%
Media Activities	82%	0%	0%	0%	18%
Metal Products (manufacture of)	0%	0%	100%	0%	0%
Non-Metallic Products (manufacture of)	0%	0%	100%	0%	0%
Other Manufacturing	0%	38%	58%	0%	4%
Other Private Services	6%	0%	0%	0%	94%
Pharmaceuticals (manufacture of)	0%	0%	100%	0%	0%
Printing and Recorded Media (manufacture of)	0%	9%	91%	0%	0%
Professional Services	98%	0%	0%	0%	2%
Public Administration & Defence	68%	0%	0%	0%	32%
Real Estate	100%	0%	0%	0%	0%
Recreation	0%	0%	0%	0%	100%
Residential Care & Social Work	0%	0%	0%	0%	100%
Retail	0%	0%	0%	0%	100%
Specialised Construction Activities	0%	99%	1%	0%	0%
Telecoms	47%	0%	0%	0%	53%
Textiles & Clothing (manufacture of)	0%	0%	100%	0%	0%
Transport Equipment (manufacture of)	0%	0%	100%	0%	0%
Utilities	0%	0%	10%	0%	90%
Wholesale	0%	0%	7%	77%	15%
Wood & Paper (manufacture of)	0%	0%	100%	0%	0%

Source: ONS BRES 2019 / Lichfields' analysis

Apportionment of Employment Sectors to Land Uses – Erewash Borough

Experian Sector	Proportion of Jobs by Use Class				
	E(g)(i)/(ii)	E(g)(iii)	B2	B8	Other
Accommodation & Food Services	0%	0%	0%	0%	100%
Administrative & Supportive Services	17%	0%	0%	0%	83%
Agriculture, Forestry & Fishing	0%	0%	0%	0%	100%
Air & Water Transport	0%	0%	0%	0%	100%
Chemicals (manufacture of)	0%	0%	100%	0%	0%
Civil Engineering	0%	0%	0%	0%	100%
Computer & Electronic Products (manufacture of)	0%	80%	20%	0%	0%
Computing & Information Services	97%	0%	0%	0%	3%
Construction of Buildings	0%	0%	0%	0%	100%
Education	0%	0%	0%	0%	100%
Extraction & Mining	0%	0%	0%	0%	0%
Finance	100%	0%	0%	0%	0%
Food, Drink & Tobacco (manufacture of)	0%	0%	100%	0%	0%
Fuel Refining	0%	0%	0%	0%	0%
Health	0%	0%	0%	0%	100%
Insurance & Pensions	100%	0%	0%	0%	0%
Land Transport, Storage & Post	0%	0%	0%	81%	19%
Machinery & Equipment (manufacture of)	0%	0%	100%	0%	0%
Media Activities	80%	0%	0%	0%	20%
Metal Products (manufacture of)	0%	0%	100%	0%	0%
Non-Metallic Products (manufacture of)	0%	0%	100%	0%	0%
Other Manufacturing	0%	78%	21%	0%	1%
Other Private Services	0%	0%	0%	0%	100%
Pharmaceuticals (manufacture of)	0%	0%	100%	0%	0%
Printing and Recorded Media (manufacture of)	0%	15%	85%	0%	0%
Professional Services	97%	0%	0%	0%	3%
Public Administration & Defence	70%	0%	0%	0%	30%
Real Estate	100%	0%	0%	0%	0%
Recreation	0%	0%	0%	0%	100%
Residential Care & Social Work	0%	0%	0%	0%	100%
Retail	0%	0%	0%	0%	100%
Specialised Construction Activities	0%	90%	10%	0%	0%
Telecoms	19%	0%	0%	0%	81%
Textiles & Clothing (manufacture of)	0%	0%	100%	0%	0%
Transport Equipment (manufacture of)	0%	0%	100%	0%	0%
Utilities	0%	0%	76%	0%	24%
Wholesale	0%	0%	14%	79%	7%
Wood & Paper (manufacture of)	0%	0%	100%	0%	0%

Source: ONS BRES 2019 / Lichfields' analysis

Apportionment of Employment Sectors to Land Uses – Gedling Borough

Experian Sector	Proportion of Jobs by Use Class				
	E(g)(i)/(ii)	E(g)(iii)	B2	B8	Other

Accommodation & Food Services	0%	0%	0%	0%	100%
Administrative & Supportive Services	13%	0%	0%	0%	87%
Agriculture, Forestry & Fishing	0%	0%	0%	0%	100%
Air & Water Transport	0%	0%	0%	0%	100%
Chemicals (manufacture of)	0%	0%	100%	0%	0%
Civil Engineering	0%	0%	0%	0%	100%
Computer & Electronic Products (manufacture of)	0%	20%	80%	0%	0%
Computing & Information Services	98%	0%	0%	0%	2%
Construction of Buildings	0%	0%	0%	0%	100%
Education	0%	0%	0%	0%	100%
Extraction & Mining	0%	0%	0%	0%	100%
Finance	100%	0%	0%	0%	0%
Food, Drink & Tobacco (manufacture of)	0%	0%	100%	0%	0%
Fuel Refining	0%	0%	0%	0%	0%
Health	0%	0%	0%	0%	100%
Insurance & Pensions	100%	0%	0%	0%	0%
Land Transport, Storage & Post	0%	0%	0%	70%	30%
Machinery & Equipment (manufacture of)	0%	0%	100%	0%	0%
Media Activities	100%	0%	0%	0%	0%
Metal Products (manufacture of)	0%	0%	100%	0%	0%
Non-Metallic Products (manufacture of)	0%	0%	100%	0%	0%
Other Manufacturing	0%	52%	48%	0%	0%
Other Private Services	0%	0%	0%	0%	100%
Pharmaceuticals (manufacture of)	0%	0%	0%	0%	0%
Printing and Recorded Media (manufacture of)	0%	17%	83%	0%	0%
Professional Services	97%	0%	0%	0%	3%
Public Administration & Defence	53%	0%	0%	0%	47%
Real Estate	100%	0%	0%	0%	0%
Recreation	0%	0%	0%	0%	100%
Residential Care & Social Work	0%	0%	0%	0%	100%
Retail	0%	0%	0%	0%	100%
Specialised Construction Activities	0%	96%	4%	0%	0%
Telecoms	82%	0%	0%	0%	18%
Textiles & Clothing (manufacture of)	0%	0%	100%	0%	0%
Transport Equipment (manufacture of)	0%	0%	100%	0%	0%
Utilities	0%	0%	89%	0%	11%
Wholesale	0%	0%	9%	77%	13%
Wood & Paper (manufacture of)	0%	0%	100%	0%	0%

Source: ONS BRES 2019 / Lichfields' analysis

Apportionment of Employment Sectors to Land Uses – Nottingham City

Experian Sector	Proportion of Jobs by Use Class				
	E(g)(i)/(ii)	E(g)(iii)	B2	B8	Other
Accommodation & Food Services	0%	0%	0%	0%	100%
Administrative & Supportive Services	12%	0%	0%	0%	88%
Agriculture, Forestry & Fishing	0%	0%	0%	0%	100%

Air & Water Transport	0%	0%	0%	0%	100%
Chemicals (manufacture of)	0%	0%	100%	0%	0%
Civil Engineering	0%	0%	0%	0%	100%
Computer & Electronic Products (manufacture of)	0%	53%	47%	0%	0%
Computing & Information Services	57%	0%	0%	0%	43%
Construction of Buildings	0%	0%	0%	0%	100%
Education	0%	0%	0%	0%	100%
Extraction & Mining	0%	0%	0%	0%	0%
Finance	100%	0%	0%	0%	0%
Food, Drink & Tobacco (manufacture of)	0%	0%	100%	0%	0%
Fuel Refining	0%	0%	0%	0%	0%
Health	0%	0%	0%	0%	100%
Insurance & Pensions	100%	0%	0%	0%	0%
Land Transport, Storage & Post	0%	0%	0%	49%	51%
Machinery & Equipment (manufacture of)	0%	0%	100%	0%	0%
Media Activities	82%	0%	0%	0%	18%
Metal Products (manufacture of)	0%	0%	100%	0%	0%
Non-Metallic Products (manufacture of)	0%	0%	100%	0%	0%
Other Manufacturing	0%	73%	26%	0%	0%
Other Private Services	5%	0%	0%	0%	95%
Pharmaceuticals (manufacture of)	0%	0%	100%	0%	0%
Printing and Recorded Media (manufacture of)	0%	17%	83%	0%	0%
Professional Services	98%	0%	0%	0%	2%
Public Administration & Defence	92%	0%	0%	0%	8%
Real Estate	100%	0%	0%	0%	0%
Recreation	0%	0%	0%	0%	100%
Residential Care & Social Work	0%	0%	0%	0%	100%
Retail	0%	0%	0%	0%	100%
Specialised Construction Activities	0%	97%	3%	0%	0%
Telecoms	65%	0%	0%	0%	35%
Textiles & Clothing (manufacture of)	0%	0%	100%	0%	0%
Transport Equipment (manufacture of)	0%	0%	100%	0%	0%
Utilities	0%	0%	13%	0%	87%
Wholesale	0%	0%	10%	79%	11%
Wood & Paper (manufacture of)	0%	0%	100%	0%	0%

Source: ONS BRES 2019 / Lichfields' analysis

Apportionment of Employment Sectors to Land Uses – Rushcliffe Borough

Experian Sector	Proportion of Jobs by Use Class				
	E(g)(i)/(ii)	E(g)(iii)	B2	B8	Other
Accommodation & Food Services	0%	0%	0%	0%	100%
Administrative & Supportive Services	20%	0%	0%	0%	80%
Agriculture, Forestry & Fishing	0%	0%	0%	0%	100%
Air & Water Transport	0%	0%	0%	0%	100%
Chemicals (manufacture of)	0%	0%	100%	0%	0%
Civil Engineering	0%	0%	0%	0%	100%

Computer & Electronic Products (manufacture of)	0%	100%	0%	0%	0%
Computing & Information Services	93%	0%	0%	0%	7%
Construction of Buildings	0%	0%	0%	0%	100%
Education	0%	0%	0%	0%	100%
Extraction & Mining	0%	0%	0%	0%	100%
Finance	100%	0%	0%	0%	0%
Food, Drink & Tobacco (manufacture of)	0%	0%	100%	0%	0%
Fuel Refining	0%	0%	0%	0%	0%
Health	0%	0%	0%	0%	100%
Insurance & Pensions	0%	0%	0%	0%	0%
Land Transport, Storage & Post	0%	0%	0%	78%	22%
Machinery & Equipment (manufacture of)	0%	0%	100%	0%	0%
Media Activities	95%	0%	0%	0%	5%
Metal Products (manufacture of)	0%	0%	100%	0%	0%
Non-Metallic Products (manufacture of)	0%	0%	100%	0%	0%
Other Manufacturing	0%	30%	70%	0%	0%
Other Private Services	3%	0%	0%	0%	97%
Pharmaceuticals (manufacture of)	0%	0%	100%	0%	0%
Printing and Recorded Media (manufacture of)	0%	29%	71%	0%	0%
Professional Services	97%	0%	0%	0%	3%
Public Administration & Defence	96%	0%	0%	0%	4%
Real Estate	100%	0%	0%	0%	0%
Recreation	0%	0%	0%	0%	100%
Residential Care & Social Work	0%	0%	0%	0%	100%
Retail	0%	0%	0%	0%	100%
Specialised Construction Activities	0%	98%	2%	0%	0%
Telecoms	33%	0%	0%	0%	67%
Textiles & Clothing (manufacture of)	0%	0%	100%	0%	0%
Transport Equipment (manufacture of)	0%	0%	100%	0%	0%
Utilities	0%	0%	10%	0%	90%
Wholesale	0%	0%	7%	88%	5%
Wood & Paper (manufacture of)	0%	0%	100%	0%	0%

Source: ONS BRES 2019 / Lichfields' analysis

Apportionment of Employment Sectors to Land Uses – Ashfield District

Experian Sector	Proportion of Jobs by Use Class				
	E(g)(i)/(ii)	E(g)(iii)	B2	B8	Other
Accommodation & Food Services	0%	0%	0%	0%	100%
Administrative & Supportive Services	13%	0%	0%	0%	87%
Agriculture, Forestry & Fishing	0%	0%	0%	0%	100%
Air & Water Transport	0%	0%	0%	0%	100%
Chemicals (manufacture of)	0%	0%	100%	0%	0%
Civil Engineering	0%	0%	0%	0%	100%
Computer & Electronic Products (manufacture of)	0%	41%	59%	0%	0%
Computing & Information Services	84%	0%	0%	0%	16%
Construction of Buildings	0%	0%	0%	0%	100%

Education	0%	0%	0%	0%	100%
Extraction & Mining	0%	0%	0%	0%	100%
Finance	100%	0%	0%	0%	0%
Food, Drink & Tobacco (manufacture of)	0%	0%	100%	0%	0%
Fuel Refining	0%	0%	0%	0%	0%
Health	0%	0%	0%	0%	100%
Insurance & Pensions	100%	0%	0%	0%	0%
Land Transport, Storage & Post	0%	0%	0%	85%	15%
Machinery & Equipment (manufacture of)	0%	0%	100%	0%	0%
Media Activities	0%	0%	0%	0%	100%
Metal Products (manufacture of)	0%	0%	100%	0%	0%
Non-Metallic Products (manufacture of)	0%	0%	100%	0%	0%
Other Manufacturing	0%	74%	26%	0%	1%
Other Private Services	0%	0%	0%	0%	100%
Pharmaceuticals (manufacture of)	0%	0%	100%	0%	0%
Printing and Recorded Media (manufacture of)	0%	6%	94%	0%	0%
Professional Services	97%	0%	0%	0%	3%
Public Administration & Defence	79%	0%	0%	0%	21%
Real Estate	100%	0%	0%	0%	0%
Recreation	0%	0%	0%	0%	100%
Residential Care & Social Work	0%	0%	0%	0%	100%
Retail	0%	0%	0%	0%	100%
Specialised Construction Activities	0%	83%	17%	0%	0%
Telecoms	91%	0%	0%	0%	9%
Textiles & Clothing (manufacture of)	0%	0%	100%	0%	0%
Transport Equipment (manufacture of)	0%	0%	100%	0%	0%
Utilities	0%	0%	18%	0%	82%
Wholesale	0%	0%	6%	71%	24%
Wood & Paper (manufacture of)	0%	0%	100%	0%	0%

Source: ONS BRES 2019 / Lichfields' analysis

Apportionment of Employment Sectors to Land Uses – Mansfield District

Experian Sector	Proportion of Jobs by Use Class				
	E(g)(i)/(ii)	E(g)(iii)	B2	B8	Other
Accommodation & Food Services	0%	0%	0%	0%	100%
Administrative & Supportive Services	11%	0%	0%	0%	89%
Agriculture, Forestry & Fishing	0%	0%	0%	0%	100%
Air & Water Transport	0%	0%	0%	0%	100%
Chemicals (manufacture of)	0%	0%	100%	0%	0%
Civil Engineering	0%	0%	0%	0%	100%
Computer & Electronic Products (manufacture of)	0%	17%	83%	0%	0%
Computing & Information Services	96%	0%	0%	0%	4%
Construction of Buildings	0%	0%	0%	0%	100%
Education	0%	0%	0%	0%	100%
Extraction & Mining	0%	0%	0%	0%	0%
Finance	100%	0%	0%	0%	0%

Food, Drink & Tobacco (manufacture of)	0%	0%	100%	0%	0%
Fuel Refining	0%	0%	0%	0%	0%
Health	0%	0%	0%	0%	100%
Insurance & Pensions	100%	0%	0%	0%	0%
Land Transport, Storage & Post	0%	0%	0%	68%	32%
Machinery & Equipment (manufacture of)	0%	0%	100%	0%	0%
Media Activities	11%	0%	0%	0%	89%
Metal Products (manufacture of)	0%	0%	100%	0%	0%
Non-Metallic Products (manufacture of)	0%	0%	100%	0%	0%
Other Manufacturing	0%	23%	77%	0%	0%
Other Private Services	2%	0%	0%	0%	98%
Pharmaceuticals (manufacture of)	0%	0%	100%	0%	0%
Printing and Recorded Media (manufacture of)	0%	0%	100%	0%	0%
Professional Services	93%	0%	0%	0%	7%
Public Administration & Defence	55%	0%	0%	0%	45%
Real Estate	100%	0%	0%	0%	0%
Recreation	0%	0%	0%	0%	100%
Residential Care & Social Work	0%	0%	0%	0%	100%
Retail	0%	0%	0%	0%	100%
Specialised Construction Activities	0%	99%	1%	0%	0%
Telecoms	88%	0%	0%	0%	12%
Textiles & Clothing (manufacture of)	0%	0%	100%	0%	0%
Transport Equipment (manufacture of)	0%	0%	100%	0%	0%
Utilities	0%	0%	68%	0%	32%
Wholesale	0%	0%	8%	74%	18%
Wood & Paper (manufacture of)	0%	0%	100%	0%	0%

Source: ONS BRES 2019 / Lichfields' analysis

Apportionment of Employment Sectors to Land Uses – Newark and Sherwood District

Experian Sector	Proportion of Jobs by Use Class				
	E(g)(i)/(ii)	E(g)(iii)	B2	B8	Other
Accommodation & Food Services	0%	0%	0%	0%	100%
Administrative & Supportive Services	14%	0%	0%	0%	86%
Agriculture, Forestry & Fishing	0%	0%	0%	0%	100%
Air & Water Transport	0%	0%	0%	0%	100%
Chemicals (manufacture of)	0%	0%	100%	0%	0%
Civil Engineering	0%	0%	0%	0%	100%
Computer & Electronic Products (manufacture of)	0%	41%	59%	0%	0%
Computing & Information Services	99%	0%	0%	0%	1%
Construction of Buildings	0%	0%	0%	0%	100%
Education	0%	0%	0%	0%	100%
Extraction & Mining	0%	0%	0%	0%	100%
Finance	100%	0%	0%	0%	0%
Food, Drink & Tobacco (manufacture of)	0%	0%	100%	0%	0%
Fuel Refining	0%	0%	0%	0%	0%
Health	0%	0%	0%	0%	100%

Insurance & Pensions	100%	0%	0%	0%	0%
Land Transport, Storage & Post	0%	0%	0%	96%	4%
Machinery & Equipment (manufacture of)	0%	0%	100%	0%	0%
Media Activities	79%	0%	0%	0%	21%
Metal Products (manufacture of)	0%	0%	100%	0%	0%
Non-Metallic Products (manufacture of)	0%	0%	100%	0%	0%
Other Manufacturing	0%	65%	32%	0%	3%
Other Private Services	1%	0%	0%	0%	99%
Pharmaceuticals (manufacture of)	0%	0%	0%	0%	0%
Printing and Recorded Media (manufacture of)	0%	6%	94%	0%	0%
Professional Services	93%	0%	0%	0%	7%
Public Administration & Defence	76%	0%	0%	0%	24%
Real Estate	100%	0%	0%	0%	0%
Recreation	0%	0%	0%	0%	100%
Residential Care & Social Work	0%	0%	0%	0%	100%
Retail	0%	0%	0%	0%	100%
Specialised Construction Activities	0%	94%	6%	0%	0%
Telecoms	29%	0%	0%	0%	71%
Textiles & Clothing (manufacture of)	0%	0%	100%	0%	0%
Transport Equipment (manufacture of)	0%	0%	100%	0%	0%
Utilities	0%	0%	80%	0%	20%
Wholesale	0%	0%	11%	62%	26%
Wood & Paper (manufacture of)	0%	0%	100%	0%	0%

Source: ONS BRES 2019 / Lichfields' analysis

Appendix 7 Avison Young 2021 M1 Corridor Market Reports

M1 Junction 24 – Junction 28

1. Introduction

- 1.1 Almost overnight the COVID-19 pandemic has fundamentally changed the way that the UK population and economy operates. Whilst it has not necessarily created new dynamics in sectors it has rapidly accelerated trends that have been slowly shifting business and consumer behaviour over the last few years.
- 1.2 Unsurprisingly this has created significant uncertainty in the economy, both in terms of its immediate performance and also the long-term implications for maintaining and growing activity across a whole range of sectors. Whilst it is clearly too early to understand the full impacts of the current crisis on the economy as a whole, and any particular sub-sectors within it, sufficient time has passed and data now available to begin to understand both the scale of short term impacts and the potential longer term implications there may be for the economy.
- 1.3 This paper has been prepared to assist in understanding the implications of the COVID-19 pandemic on the industrial and logistics sector specifically. It is intended to provide an overview of known impacts in the short term and explore what these may mean in the future, it then considers what this may mean for demand for industrial and warehouse space in the medium and long term in the area running along the M1 corridor from Junction 24 through to Junction 28. This area includes the following sub-markets:
- Bolsover (Derby)
 - Erewash (Derby)
 - North West Leicestershire (Leicester)
 - Ashfield (Nottingham)
 - Broxtowe (Nottingham)
 - Rushcliffe (Nottingham)
- 1.4 The analysis has been undertaken in January 2021 and draws on the data available at that point in time. However, it should be noted that given the speed of the pandemic's impact on the UK economy data is not always available to demonstrate trends, as such other qualitative information is provided. All information is presented in good faith and is accurate at the time of writing, however as more information is published there may be different outcomes to those considered here.

2. Immediate Impacts

- 2.1 As the UK entered lockdown in March the economy was broadly split into two categories – those activities deemed 'essential' and 'safe' to continue to operate, and those that weren't and as such were forced to close. This had immediate impacts across all sectors and created two different elements within the industrial and logistics sector:
- High performing – those that were able to continue trading and ultimately serviced increasing levels of demand, these included e-commerce, grocery retail, pharmaceuticals, and health care.
 - Low performing – those that were forced to dramatically reduce activity or close altogether either as a direct impact (such as the automotive sector) or because they formed part of a supply chain to a directly affected industry (such as parts suppliers to the aviation industry).
- 2.2 Despite this 'two speed' dynamic in the sector overall demand is reportedly 24% up on pre-lockdown figures, primarily driven by demand for logistics space following an acceleration in e-commerce activity but also a result of increased needs in the food, third party logistics (3PL), pharmaceutical and healthcare sectors – all of which require additional capacity for storage and distribution of inventory.
- 2.3 More widely even low performing sectors have seen a need to continue to demand space. All elements of the industrial/logistics market have been challenged by the need to operate within social distancing guidelines (making space less productive) and also increased stock storage requirements – either through mounting backlogs or a desire to hold more contingency stock.
- 2.4 Over the time, businesses have slowly adapted to the context of Covid-19 and got organised to resume activities. Today, most businesses are operating although with strict measures in place to ensure the safety of their employees. Those measures would have led to either a need for additional space or a scale-down of activities as more space per employee is required.
- 2.5 Analysis of demand suggests that the East Midlands has continued to be a focus for logistics activity, reflective of its prominent role in England in this sector, with the second highest level of investment across all UK regions during the lockdown period according to data published by CoStar.
- 2.6 In terms of leasing activity (B8 only), based on CoStar data, we can observe a slow-down of activity on the English market with a drop of 28% in deals and 36% in floorspace leased between April 2020 and December 2020 compared to the average for the same period over the previous 4 years.

Table 1 – April to December Lease Activity (B8), England

England	Deals	SF Leased	Average SF Leased
Average 2016-2019	855	25,461,778	29,771
2020	613	16,251,205	26,511
Change	-28%	-36%	-11%

Source: CoStar, October 2020

- 2.7 On the other hand, the East Midlands Market remained strong and registered a growth between April 2020 and December 2020 compared to the average of the same periods over the previous 4 years. The East

Midland market registered an increase of 18% in floorspace leased, whilst number of deals signed remained comparable. This suggests an increase demand for larger units in recent months.

- 2.8 It can also be noted that historically, the East Midlands is characterised for a higher demand for larger units than the national average (over 40,000 sqft in average in the East Midlands against below 30,000 sqft nationally).

Table 2 – April to December Lease Activity (B8), East Midlands

East Midland	Deals	SF Leased	Average SF Leased
Average 2016-2019	90	3,706,051	41,408
2020	91	4,360,182	47,914
Change	+2%	+18%	+16%

Source: Avison Young, based on CoStar, October 2020

Rise in E-Commerce

- 2.9 Covid-19 has led to legislated social distancing around most of the world. As such initially in the UK only those establishments deemed essential to meet people's day to day needs have remained in operation, with whole sections of the economy closed for over three months.
- 2.10 The impact on the retail sector has been widely reported, seeing all but a few 'essential' shops remaining open in that period, preventing people from visiting town centres to meet their wider needs and seeking alternative ways of buying products. Food retail continued to trade throughout the lockdown period - however due to social distancing, long queues and general concern about leaving one's house, demand for internet shopping (e-commerce) has grown.
- 2.11 The UK already had the highest penetration of online sales in the world and the lockdown has accelerated this trend with a rapid acceleration of this ratio in the second quarter of 2020, when the UK entered into full lockdown. ONS data shows that whilst this penetration ratio has slightly decreased in Q3 of 2020, it remains will above the level it would have been expected to be at this time without Covid-19 (as shown by the dotted trendline in Figure 1).

Figure 1 – Internet Sales as a Percentage of Total Retail Sales (%)

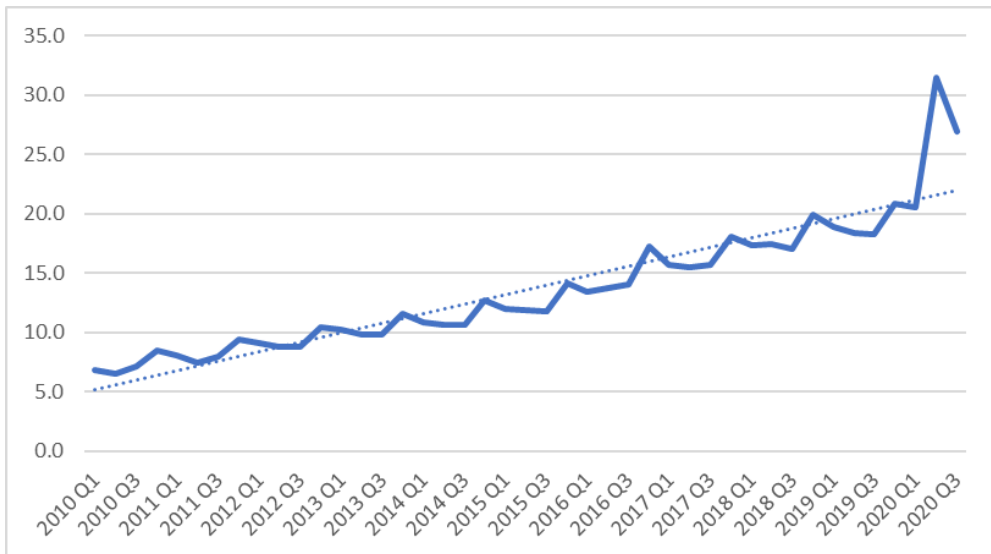

Source: ONS, Retail Sales Index, 23 October 2020

- 2.12 Data from the Office for National Statistics published in October 2020 shows that retail sales suffered from the implementation of the lockdown at the end of March with a drop in retail sales of 6% in March 2020 from the previous month and a further drop of 19% in April from March. Retail sales recovered rapidly in the following months and was already above their February level by the end of July.
- 2.13 Meanwhile, internet sales benefitted from this situation. Internet sales have consistently increased over the lockdown period, from March to June (+60% over this period; against -3% for retail sales) before slowly going down in the following month, without however dropping back to their initial levels pre-Covid-19.

Figure 2 – Retail Sales vs. Internet Sales, Indexed

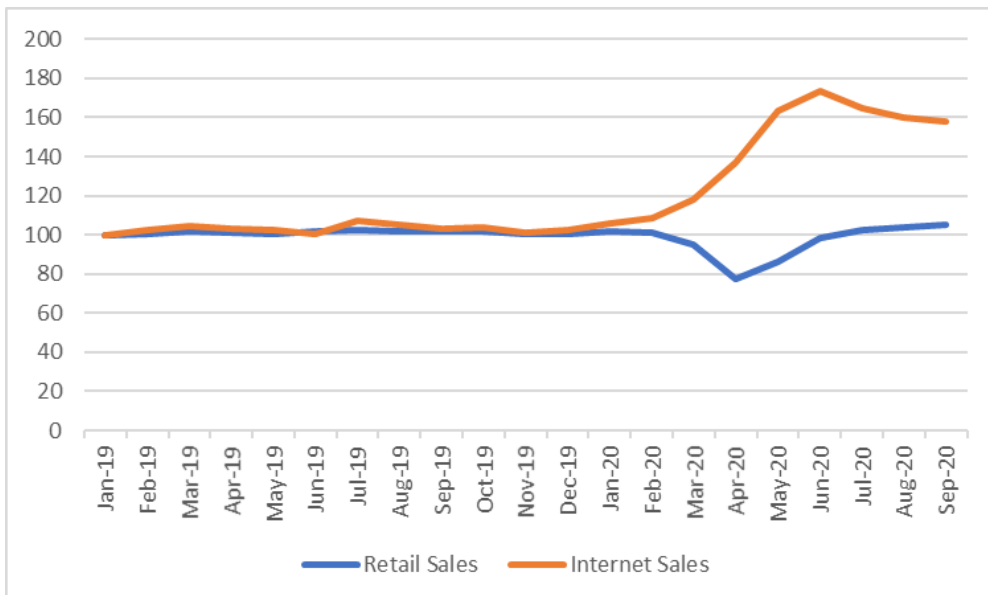

Source: ONS, Retail Sales Index, 23 October 2020

- 2.14 E-commerce can generally be split into three main categories: food; non-food (clothing, households, etc.) and non-store retailing (i.e. online services). Activity in all parts of the industry have increased, with a 53% rise in year on year online grocery sales for September; a 92% increase in non-food sales and a 61% increase in non-store sales.

Figure 3 – Internet Sales, Indexed

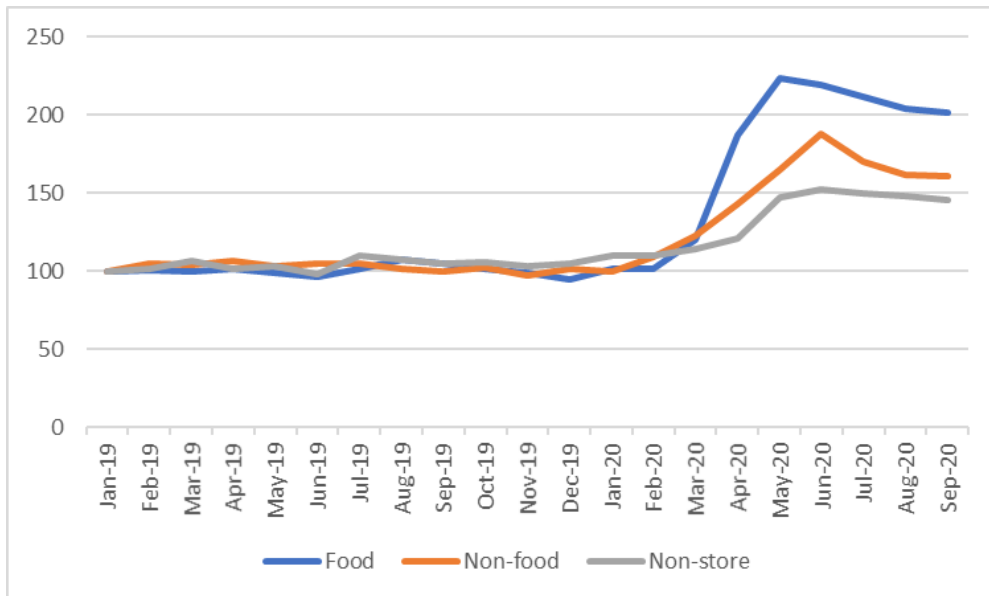

Source: ONS, Retail Sales Index, 23 October 2020

- 2.15 This huge spike in demand has led to an immediate reaction across the e-commerce sector. Retailers have rapidly upgraded their digital platforms to improve experience and reliability whilst simultaneously increasing their distribution infrastructure across the country. Both are major investments and can be seen as moves that will make a number of these immediate reactions more permanent features of the sector.
- 2.16 On the food side sales have increased significantly, both from direct deliver services and those completed from in store, with many consumers finding it challenging to secure home delivery slots, which in turn led most of the major stores to increase their distribution capabilities. As an example of the scale of the impact in early May 2020, Ocado (which acts as a marketplace for a number of food retailers and therefore has no store presence) announced that their year on year revenues were up 40.4% in 2020 compared to Q2 in 2019.
- 2.17 Ocado's Group chief executive Tim Steiner noted both the pace of change and its permanence in his comments alongside the published trading figures, stating: *"We are facing quite a different challenge to many, as we scale up Ocado.com to play its part in feeding the nation, and as we help our clients launch and roll out their online businesses more rapidly against a backdrop of a likely long term increase in demand for online."*
- 2.18 As high street stores closed the focus of consumers switched to online sources for all other product purchases. A recent Morgan Stanley poll suggested 46% of people in the UK are now buying more non-food items online than they had been pre-lockdown and (critically for longer term space needs) are happy to continue to do so in the future¹.

Short Term Response in Demand

- 2.19 These changes to consumer spending habits have driven significant demand for space in key locations, in particular in the East Midlands with several major (100,000sqft +) deals completed with e-fulfilment occupiers.

¹ <https://www.propertyweek.com/insight/a-new-industrial-age-is-dawning/5107794.article>

The core activities driving this demand are major supermarkets, e-commerce and third-party logistics providers – unsurprisingly including high demand from specialist health and pharmaceutical operators.

2.20 Data from CoStar shows that there have been 10 deals signed for B8 use space of 100,000sqft + in the East Midlands between January 2020 and December 2020. This represents 9% of all deals signed over this period. In terms of comparison, 40 deals have been signed in the England for the same size of B8 space, over the same period, representing only 5% of all deals signed.

2.21 Consumer demand has not been the only driver of demand for additional space with many retailers now managing significant backlogs of stock that has not been able to be sold in stores and is now out of season. As manufacturing in the Far East and Turkey has geared up, shipping routes have reopened and ports increased activity many retailers/suppliers are also managing an influx of autumn/winter season stock which may never be sold given that the UK or parts of the UK could go back into stricter levels of lockdown.

2.22 These stock issues coupled with retailers seeking to build up contingency in high demand goods has led to an increase in demand for space on short term leases.

2.23 13 leases for B8 space has been signed for a period of 2 years or less in the East Midlands between April 2020 (roughly the start of lockdown) and December 2020. This compare with an average of only 4 deals for B8 space for the same period in 2016-2019.

2.24 In the England, the average lease term has dropped from an average of 103 months during the period 2016-2019 to only 73 months in 2020. The same observation can be made in the East Midlands, with a drop of average lease term from 96 months in 2016-2019 to 77 months in 2020.

Table 3 – Average Lease Term (month)

	England	East Midlands
2016	107	87
2017	108	105
2018	104	99
2019	92	97
2020	73	77

Source: Avison Young, based on CoStar, October 2020

2.25 There remains a number of large requirements still unsatisfied in the market, initially driven by grocery demand but now expanded to a much wider range of logistics activity and also including manufacturing activity most notably in healthcare. Locations which offer good access to multiple markets have been in particular demand.

Challenges in Other Industrial Activity

2.26 Outside of the e-commerce activity the industrial/logistics sector has seen more challenging trends. The latest ONS indicates that in August 2020 the Index of Production was 6.0% below February 2020, the previous month of "normal" trading conditions, prior to the coronavirus (COVID-19) pandemic. Production output rose by 0.3% between July 2020 and August 2020, with manufacturing providing the largest upward contribution, rising by 0.7%; electricity and gas also rose (1.6%), partially offset by a fall in mining and quarrying (-4.1%).

- 2.27 However, most productive sectors are still well below their February level, with manufacturing being 3.4% below its February level in August 2020.
- 2.28 The latest MARKIT sentiment survey suggests business sentiment is increasing in the manufacturing sector.
- 2.29 These headline figures mask mixed performance at the manufacturing sub-sector level. Unsurprisingly there has been an increase in output within the pharmaceuticals sub sector, with month-on-month growth of c.1.6% between February 2020 and August 2020, based on ONS Index of Production.
- 2.30 However wider medical /healthcare output fell as increased demand for PPE and medical equipment was offset by a fall in demand for other products linked to more routine health care activity such as dentistry.
- 2.31 Unsurprisingly other sectors have seen sharp falls in month-on-month output, driven by a collapse in consumer demand and the shutdown of core UK production sectors leading to decreased supply chain activity.
- 2.32 The most prominent impacts of this have been felt in the automotive and aviation sectors. The grounding of the majority of flights internationally and moth-balling of major plane fleets has led to a major downturn in the wider sector and supply chain both for the production of new aircraft and the manufacture of components for maintaining existing planes.
- 2.33 In the automotive sector there was a 90% fall in activity in the first full month of lockdown, with virtually all production ceased and sales made from existing inventory. In some areas this fall may have been 'softened' as businesses diversified into other products such as PPE or medical equipment to help meet increased short-term demand and retain their need for both space and workers.

3. Medium-Long Term Prospects

- 3.1 Beyond the immediate crisis both the pre-existing trends and the amplification provided by the lockdown period suggest that the industrial and logistics sector will continue to perform strongly, despite some concerns about the likelihood of a second lockdown and a risk of a sharp rise of unemployment following the termination of the furlough scheme (or it's replacement by a less supportive scheme).
- 3.2 Across all activities social distancing has an immediate impact on productivity of industrial space as fewer workers can be accommodated in a building. Looking ahead it is expected that, whilst not so extreme, this practice will leave a legacy in terms of building design via an increased focus on 'wellness' of buildings, which may require more space to accommodate appropriate space for workers. In turn this will mean an increased need for new stock that can meet contemporary the needs of occupiers and their employees.
- 3.3 3.3 Overall, despite some challenges in the production side of the industrial/logistics sector most market analysts expect stock absorption to remain positive going forward, even if the record levels of take up are not repeated.

Logistics

- 3.4 As noted in the previous section it is expected that the trend towards greater e-commerce activity will continue and is likely to grow at a faster rate than predicted pre-pandemic. Indeed very early indications are that as retail reopens consumers have focused on those that have no online presence for store visits, with shorter queues for those that could be accessed virtually throughout the period – suggesting that e-commerce has become an ingrained part of our retail experience.
- 3.5 The impacts of the virus have also illustrated the need for more stock holding / contingency capacity to increase resilience in supply chains and for stores. In the medium term this is likely to result in a demand for more space to hold stock within the UK, effectively 'on-shoring' storage activity that is currently undertaken overseas.
- 3.6 The nature of how logistics activity is conducted will also change. It is expected that higher levels of automation will become the industry standard, with less reliance on human capital for more basic tasks – protecting businesses from any future pandemic risks. Future jobs will be in more skilled activities.
- 3.7 These dynamics will drive a corresponding increase in requirements to accommodate these evolved operating norms. Automation and increased e-commerce volumes will drive demand for larger spaces, most likely located in close proximity to large urban areas to ensure operational efficiency. The holding of increased stock may require smaller units that are easily accessible to points of entry to the UK.
- 3.8 Amazon provides a good bellwether for the logistics sector more widely. Already a dominant force in the warehouse market it is reported to be looking to secure another 5mn sqft across the UK in the coming years. Recent moves by the online retailer have indicated a new hub and spoke approach to enable faster delivery responses and simplifying access for vans/LGVs rather than HGVs. This will create a series of smaller facilities close to their major distribution hubs across the UK, further increasing their demand for property.
- 3.9 It is likely that other e-commerce businesses will follow a similar trajectory, increasing their overall footprint and mix of spaces across the UK. This will have a knock-on impact for demand from a range of supply chain businesses, not least 3PL's, packaging and waste operators.

Production

- 3.10 Prior to the pandemic the manufacturing sector in the UK was showing some positive performance, albeit more in terms of stable levels of output rather than significant growth – largely as the UK focused more on higher value output rather than large scale mass production.
- 3.11 Looking ahead, despite the uncertainty caused by COVID-19 and the UK's withdrawal from the EU, forecasts suggest that manufacturing will see a moderate downturn overall with an expectation of recovery in output levels in the medium term. The latest forecasts from Experian suggest that in a moderate scenario output would return to pre-COVID levels and begin to grow again around 2023.
- 3.12 The COVID-19 crisis has provided a clear reminder of how inter-connected the global economy has become and highlighted the risks to businesses and the economy of an over-reliance on international supply chain in times when free movement becomes more restricted or stopped altogether.

- 3.13 In the medium to long term there is likely to be some re-shoring of critical production factors, particularly within a range of vital services that have been highlighted as deficient in the current crisis. Whilst this will not affect all parts of the manufacturing sector there is likely to be a return to some expanded domestic production in health, pharmaceuticals and engineering activity.
- 3.14 The 're-design' of many workspaces is likely to be a factor in this domestic production. In light of UK companies preparing to go back to work and return to highly populated offices, a recent return to work survey found that two thirds of office workers want masks and plexiglass desk shields² and as companies try to reduce employee concerns it is likely demand will continually increase for these items. Like social distancing, whilst this trend may not be embedded at such extreme scale as currently experienced there will continue to be a need for different products to deliver a safe and healthy working environment.
- 3.15 Outside of traditional production sectors the changes to previous working patterns will also increase the demand for industrial space. Even once restrictions are lifted the expectation is that the number of people working from home will remain high for the foreseeable future and we may well see a long-term shift toward more homeworking.
- 3.16 This will require businesses to have much more resilient and higher capacity digital infrastructure, increasing the demand for cloud-based IT systems which, in turn will mean data centers will need increased capacity.

4. Impacts for the M1 J24/28 Area

- 4.1 As explored in the previous sections many of the COVID-19 impacts are fast becoming embedded trends in the population, accelerating a number of changes that were already occurring and introducing new dynamics in the way we live and businesses interact with their supply chains and customers.
- 4.2 Due to rising demand from e-commerce, illustrated by food, non-food and non-store online retailers, online shops will increasingly require larger warehouses and distribution space in order to hold, process and distribute this added stock. The general consensus from the industry is that "*warehouses will now be viewed as essential national infrastructure*"³ and therefore supply pipeline will need to be strong across the country.
- 4.3 In particular, locations that offer attractive conditions for distribution activity will be privileged by the industry for regional and national distribution activities in order to minimise their costs. Area characteristics would include:
- Ease of access to customers (proximity to strategic road network)
 - Ease of access to suppliers (proximity to strategic road network and major (international) transport infrastructure such as ports or airports)
 - Access to suitable workforce (low skilled for parcel handling activities to highly skilled for robotics and automation, logistics planning, etc.)
- 4.4 The area running from Junction 234 on the M1 to Junction 28 is therefore considered as a prime location for this type of activities as it gives access to a large number of major cities in England (Sheffield, Leeds, Birmingham in less than 1 hour, Manchester in 2 hours, Liverpool and London in 2.5 hours).

<https://www.eqi.co.uk/news/two-thirds-want-masks-and-shielded-desks-enforced-in-workplace/>³
<https://www.propertyweek.com/insight/a-new-industrial-age-is-dawning/5107794.article>

4.5 The area also has easy access to major international freight infrastructure (25 mins to East Midlands Airport). and to a wide labour pool with the proximity of a number of larger cities (Chesterfield, Derby, Leicester, Loughborough, Mansfield, Nottingham, Sheffield).

4.6 This area is identified in Figure 4, with in red the section of the M1 running from Junction 24 to the south all the way up to Junction 28 to the north. This section of the M1 runs across the following 4 boroughs (identified in blue on the map):

- Bolsover (Derby)
- Erewash (Derby)
- North West Leicestershire (Leicester)
- Ashfield (Nottingham)
- Broxtowe (Nottingham)
- Rushcliffe (Nottingham)

Figure 4 – M1 J24/28

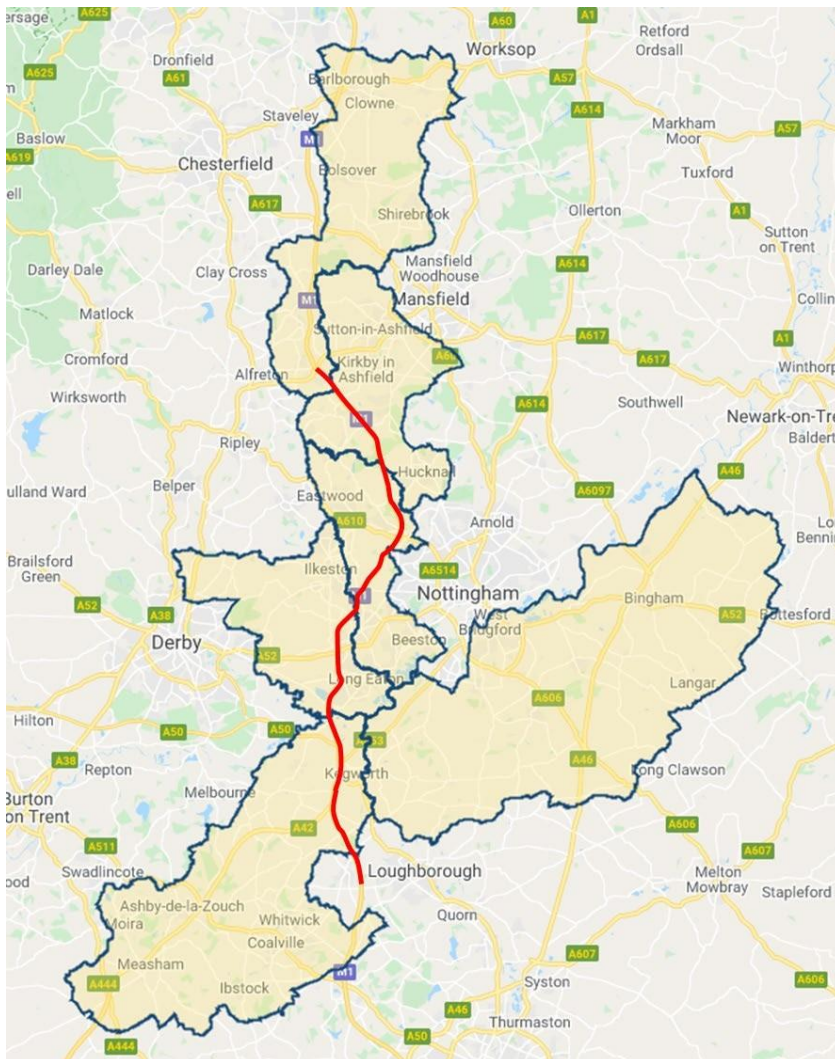

Source: Avison Young

- 4.7 Successful retailers now and in the future are those that have (or are moving) to multi-channel formats, combining a high street presence with strong online service. This creates a dual need from logistics space to serve customers (store replenishment and direct customer servicing) as well as a more dispersed returns strategy capable of collecting returned goods (which happen more often than in result from purchases in physical stores) in a cost effective manner.
- 4.8 This new form of retailing will require significantly more space than traditional models. Recent analysis by Prologis suggested that e-commerce required up to three times the amount of warehouse space than a store-based operation in order for it to handle the mix of replenishment and returns activity.
- 4.9 These demands will be most acutely focused in areas with high population density and/or high levels of population growth in the future as occupiers seek to locate in areas where they have good access to a large population as the focus of logistics activity continues to shift from business to business toward business to customer servicing.
- 4.10 The M1 J24/28 lies in an ideal location to serve the expanding populations within this part of the East Midlands and in neighbouring areas.
- 4.11 Additionally, the M1 leads to cities such as Sheffield, Leeds, Newcastle and Edinburgh to the north and Leicester, Northampton, Milton Keynes, Luton and London to the south.
- 4.12 Research by the British Property Federation (What Warehousing Where, 2019)¹ suggested that at present the UK economy requires 69sqft of warehouse floorspace per home; therefore, to maintain the 'status quo' the 3 counties would need to provide at least 3.72 million sqft of additional space by 2036 (excluding North West Leicestershire, which is well served), based on ONS population projections.
- 4.13 The report notes that this ratio does not fully reflect the increasing demand for e-commerce and last mile delivery floorspace and that the 69sqft figure was likely to need to increase as these trends grow. Clearly the acceleration in e-commerce activity over the last few months discussed in this paper underlines the need to ensure sufficient space is provided in this locality to meet future demand.
- 4.14 Recent data from CoStar (8th January 2021) indicates that the M1 J24/28 area, excluding North West Leicestershire (which is well served) has only enough vacant floorspace at present to accommodate 24% of this demand. It is to be noted that a minimum level of vacancy should always be maintained to the health of the industry in the local economy (as businesses need readily available space to expand, relocate to better premises and adapt to real estate strategy to changing market conditions). The area has a current vacancy rate of 3.7%, which could already be considered as being below a healthy level. It is therefore certain that significant additional floorspace will be required to respond to the growing demand.
- 4.15 When looking at annual net take-up data, the situation is even more concerning. Indeed, CoStar data shows that the average annual net take-up of space over the past 10 years (2010-2019) has been of c. 820,000 sqft in the M1 J24/28 area. With currently 2 million sqft of vacant floorspace, the M1 J24/28 area has sufficient space to respond to the demand for the next 2.5 years only.

¹ <https://static.turley.co.uk/pdf/file/2019-03/BPF%20What%20Warehousing%20Where%20Report.pdf>

- 4.16 As set out in this note it is likely that demand will accelerate and be higher in the future than the past both from changes to the industrial/logistics sector and also population growth. As such, 2.5 years supply, which is already considered extremely low, is likely to be, taken up in less than 2 years.
- 4.17 Data for 2020 shows that there has been an increase in leased floorspace compared to the average of the previous 4 years (2016-2019), with a demand for larger units.

Table 4 – April to December Lease Activity (B8), M1 J24/28

	Deals	Floorspace (sqft)	Average Floorspace (sqft)
Average 2016-2019	13	1,422,780	111,591
2020	14	1,735,061	123,933

Source: Avison Young, based on CoStar, October 2020

- 4.18 It should also be noted that, unlike in the East Midlands or in England, the average lease term agreed has not decreased in 2020 or since April 2020, and to the contrary has increased. This could indicate that the area is seen as a long-term strategic location for the logistics and distribution industry as opposed to a short-term investment to respond to the initial need for space generated by the Covid-19 crisis.

Table 5 – Average Lease Term (month)

	M1 J24/28
2016	129
2017	104
2018	132
2019	126
2020	137 (153 since April 2020)

Source: Avison Young, based on CoStar, October 2020

- 4.19 Warehousing and logistics underpin the efficient operation of most, if not all, business sectors as such the provision of appropriate types and scales of space in the right locations with strong access is vital not just for the sector itself but for economic performance more widely.
- 4.20 4.19 This part of the East Midlands in particular is already a focus of major economic activity in this sector due to its strategic geographical position in the UK and excellent strategic road network. Other factors, beyond population led logistics demand, as explained in the report will increase the demand for space in the area coming from both B8 businesses and their supply chain. These factors include the rise of e-commerce, the importance of national logistics and ability to build up stock contingency in response to Covid-19 and Brexit or the acceleration of the economy (goods need to be transported and delivered ever faster).

5. Conclusion

- 5.1 Covid-19 has had a significant impact on the world's economy and on the way consumer behave.
- 5.2 In England, following the successive lockdowns, the economy has broadly split into two categories – those

activities deemed 'essential' and 'safe' to continue to operate, and those that weren't, with 'essential' and/or 'safe' activities plugging some of the gap created in the market and responding to the demand. As a result, and as soon as March 2020, we observed a sharp increase in e-commerce, across all sectors (food, non-food, and non-store).

- 5.3 This resulted into an increase demand for logistics, warehousing and distribution space (B8). Whilst figures from CoStar indicates that there has been a reduction in overall lease activity in England between April 2020 (rough start of first lockdown) and December 2020 compared to the average of the same period over the previous 4 years, the East Midland market and the M1 J24/28 area have particularly well performed, with an increased number of lease signed in 2020 (April to December) compared to the historical average. Overall, signed deals tended to be for smaller units (in average), with however some large units signed.
- 5.4 Overall, in the medium to longer term, we expect to see a continued increase in demand for B8 space, particularly focused in prime locations (such as the M1 J24/28 area) due to the impact of Covid-19 on consumers' behaviour and the rise of e-commerce; the renewed importance of building up stock contingency; the progression of technology (space requirement to accommodate that technology within logistic activities as well as increase demand from data centres); or the reshoring of some of the production (increasing the demand for industrial space but also for B8 space for additional warehousing and distribution).
- 5.5 The East Midland and the M1 J24/28 area can be considered prime locations for B8 activities due to the strategic geographical position within England and the UK, the provision of an excellent strategic road network and major freight infrastructure. This is particularly true for the M1 J24/28 area and may be reflected in the resilience of long-term leases in the area in 2020 (as opposed to England or the East Midland where we observed a slight decline in average lease terms).

Appendix 8 Experian Data Guide: UK Regional Planning Service (September 2020)

Data Guide

UK Regional Planning Service
September 2020



Our main subscription website:

<https://www.experian.co.uk/business/business-information/market-intelligence/economic-services/>



Data Guide

UK Regional Planning Service
September 2020

Contents

Executive summary	1
1 Variable Coverage	2
2 Historical End-points	3
3 Methodology	4
3.1 UK Methodology	4
3.2 Regional methodology	5
3.3 Local methodology	9
4 Key changes since June 2020 RPS	13
4.1 UK forecast	13
4.2 Regional Forecast	15
4.3 Local Forecast	15
4.4 Population	15
5 A note from the ONS on volatility	16
Appendix A...Glossary of terms	17
Appendix B...Sector definitions	20
Appendix C...Geography definitions	24
Appendix D...FAQ's	25
Appendix E...About us	28

Executive summary

This document outlines the current variable coverage in the June 2020 version of the UK Regional Planning Service, and the methodology behind the history and forecast.

[Appendix A](#) includes a glossary of terms.

[Appendix B](#) includes our definitions of the sectors.

[Appendix C](#) has the geography definitions.

[Appendix D](#) contains the most common Frequently Asked Questions

Contact us

Sadia Sheikh

Head of B2B Economics

T 44 (0) 207 746 8250

E sadia.sheikh@experian.com

Ragini Madan

Senior Econometrician

T 44 (0) 207 746 8219

E ragini.madan@experian.com

Rebecca Snow

Managing Economist

T 44 (0) 7966 874 720

E rebecca.snow@experian.com

Harvir Dhillon

Economist

T 44 (0) 207 742 4608

E harvir.dhillon@experian.com

Hasnath Chowdhury

Economist

T 44 (0) 203 042 4678

E hasnath.chowdhury@experian.com

Experian

Cardinal Place

6th Floor

80 Victoria Street

London SW1E 5JL

www.experian.co.uk/economics

This output is based on and comprises both your input and information sourced from third parties (which may include public data sources). Whilst we will use all reasonable care and skill in the collection and collation of this output we cannot warrant or guarantee the accuracy of the output. You acknowledge that outputs which use empirical data and/or statistical data and/or data modelling techniques cannot be taken as a guarantee of any particular outcome and are not intended to be the sole basis of your business decisions. Our standard terms of business apply.



1 Variable Coverage

To avoid implying spurious accuracy, we now round all county and local series to the nearest tenth of a unit. This means that people or job counts are now to the nearest 100 people or jobs and money counts are to the nearest £100,000, and rates are now to the nearest 0.1 percentage points. Forecasts for series with very small levels may appear to be very volatile when growth rates are considered. We, therefore, recommend viewing series with small values in levels not growth rates or considering growth rates over longer intervals than annually. Very small levels have been set to zero as they are essentially statistical artefacts.

Figure 1.1: Variable coverage in the RPS

- ✓ indicates that the variable is available in both the search query tool and the xls files.
- Xls indicates that the variable is available in the xls but not the search query tool.
- UK monthly forecast indicates that the variable is not produced as part of the RPS but can be found in the monthly UK macro forecast on our website.

Variable	UK	Region	County & Local Authority
PRODUCTION			
GDP	UK monthly forecast		
GDP by component of demand	UK monthly forecast		
Gross Value Added	✓	✓	✓
GVA by sectors	✓	✓	✓
LABOUR MARKET			
Employees by sector	✓	✓	✓
Self-employed by sector	✓	✓	✓
Government Trainees by sector	xls	xls	Upon request
Her Majesties Forces Total	xls	xls	Upon request
FTE Employment by sector	✓	✓	✓
Total ILO Employment – Residence based & Workplace based	✓	✓	✓
ILO Unemployment	✓	✓	✓
Unemployment rate	✓	✓	✓
Labour Force	xls	xls	Upon request
Activity Rate	xls	xls	Upon request
Inactivity Rate	xls	xls	Upon request
DEMOGRAPHICS			
Population: Total, Adult (16+)	✓	✓	✓
Age bands: 0-15, State Working age, State retirement 16-64, 65+	✓	✓	✓
Population by single or 5 year age band	Upon request	Upon request	Upon request
HOUSEHOLDS			
Nominal disposable Income	✓	✓	✓
Real disposable income	✓	✓	✓
Nominal income by component	xls	xls	Upon request
Nominal consumer spending	✓	✓	✓
Real consumer spending	✓	✓	✓
Consumer spending by COICOP category	Upon request	Upon request	
Cost of Living Index	✓	✓	
House price Index	✓	✓	Upon request
Hours worked	Upon request	Upon request	Upon request

Please note we are no longer publishing Claimant Count for Regional and Local Areas. This is due to the fact that complete data are no longer available due to the shift to Universal Credit.

2 Historical End-points

Figure 1.2: Last historic data point

Variable	UK*	Region	County & Local Authority
Gross Value Added	2020q2	2018q4	2018q4
GVA by sectors	2020q2	2018q4	2018q4
Labour market variables	2020q1	2019q3	All 2018q4 except ILO 2019q3
Income	2019q4	2018q4	2017q4
Consumer spending	2020q1	2018q4	2017q4

The historical end-point represents the last period in time for which we apply our processes to collect, calculate or derive data, details of which can be found in chapter 3: Methodology. All time-periods that are in the past but follow the historical end-point are Experian Economics' estimates.

We have not used any regional data published after January 2020 in producing this update of the RPS. It is possible that between this date and the release of the RPS some new history may have been released and/or revised.

Population

The population data provided are the Office for National Statistics (ONS) 2016 mid-year estimates for 1997-2016. For England, Scotland and Wales, the 2016-based national population projections are used while 2016-based sub-national population projections for England and Scotland have been used for the first time. Sub-national projections for Wales remain 2014-based. Further information on population changes is available in [section 4](#).

UK forecast

This forecast is consistent with an Experian Economics' August 2020 macroeconomic forecast which includes GVA for 2020q2. We explore this further in [section 4](#).

Geographic boundaries

As of March 2020, data is published in accordance with Local Authority District Boundaries (April 2019). With the ONS gradually phasing out the publication of data on the pre-2019 local authority boundaries, it had become increasingly less credible for Experian to publish up-to-date historical data on these definitions. The table below shows those local authorities which no longer exist as individual entities (2nd column) and the name of the new local authority that has been created by their merger.

Region	Disbanded local authorities	Merged to form:
<i>East of England:</i>	Suffolk Coastal, Waveney	East Suffolk
	Forest Heath, St Edmundsbury	West Suffolk
<i>South West:</i>	Bournemouth, Christchurch, Poole	Bournemouth, Christchurch and Poole
	East Dorset, West Dorset, North Dorset, Purbeck, Weymouth and Portland	Dorset
	West Somerset, Taunton Deane	Somerset West and Taunton

3 Methodology

3.1 UK Methodology

The approach for the regional planning service takes the UK variables as exogenous, imposed from the monthly UK forecast.

To produce the UK forecast we use a heavily customised version of the National Institute of Social & Economic Research's (NISER) model called NIGEM to provide our core macroeconomic forecast.

NIGEM is a general equilibrium model of the UK and World economy which forecasts, amongst other variables, aggregate GVA, expenditure, income and employment based on the UK National Accounts published by the Office of National Statistics.

To split this core forecast out into industries and sub-sectors we have a Sectoral Model which expands on the forecasts from the core NIGEM model.

We disaggregate total consumption (C), investment (I), government spending (G), stocks (S), exports (X) and imports (M) from NIGEM to a finer level of detail. This provides a highly detailed model of demand (Q) for industry GVA in the UK economy. Using converters derived from the ONS Supply and Use Tables, we convert demand into intermediate (VAI) and final (VAF) value added for each sector. This provides a comprehensive view of how value added is distributed across sectors. The growth rate of total value added (VA) for each industry determines its GVA (Y) growth rate. GVA is constrained in order to forecast total GVA from NIGEM. This Input-Output based model is iterative and captures intra-industry demand.

The industry GVA forecast is used together with wage forecasts to forecast employment by sector (E).

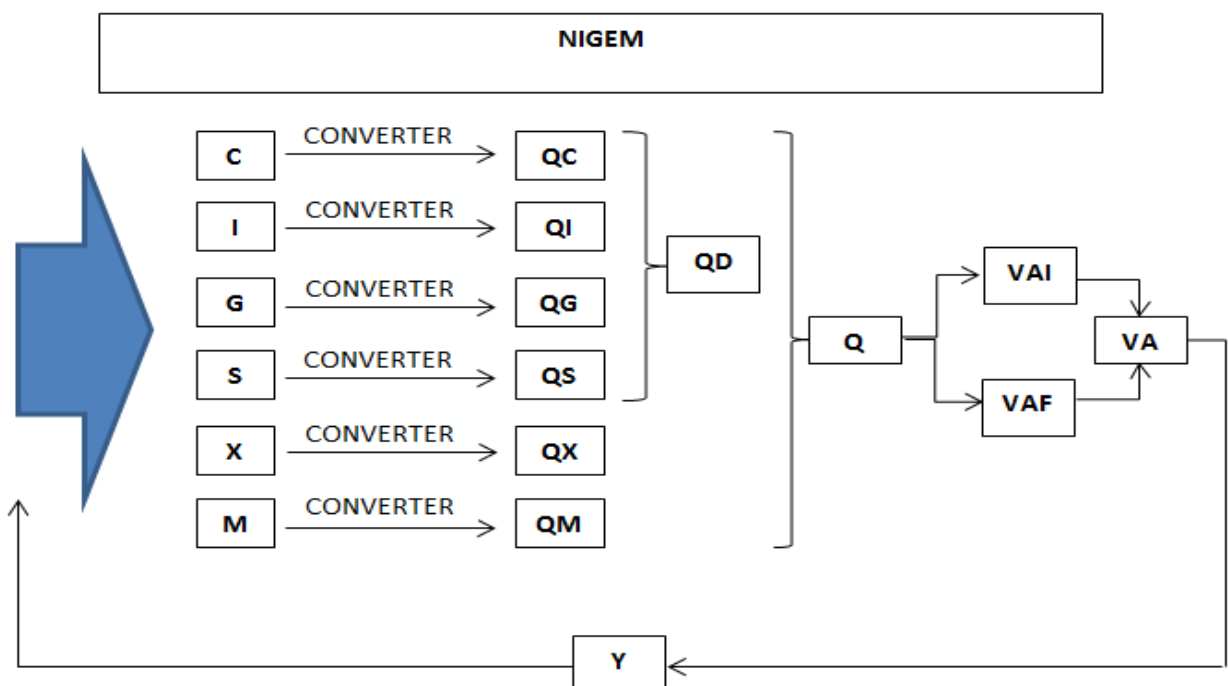

3.2 Regional methodology

3.2.1 History

All economic history used in the RPS is derived from official statistics published by the UK's Office for National Statistics (ONS). Our approach is to use existing statistics in the form they are published to the greatest extent possible. However, this is subject to the following exceptions:

- where there is a lag between an update of aggregate data and the corresponding disaggregation, the disaggregate data is constrained to match the latest aggregates;
- where ONS data is not published at quarterly frequency (for instance it is only annual data), we use a consistent methodology (described below) to construct quarterly data;
- where ONS data is not published at the geography required or in the detail required, we use a consistent methodology to add the necessary data, ensuring that it constrains to published data at a higher level of geography or detail;
- on occasion, where ONS data is internally inconsistent we apply techniques to remove these inconsistencies.

The most timely and reliable data at the regional level is the workforce jobs series, published on a quarterly frequency by the ONS. There have been revisions to estimates of Workforce Jobs going back several years caused by benchmarking to the latest estimates from the annual Business Register and Employment Survey (BRES), updating seasonal factors and taking on board late information.

Employee jobs, self-employed jobs and government trainees are published at the level of the SIC 2007 Section providing us with 22 sectors.¹ In order to disaggregate this Section-level data to 2-digit sectors from which we can construct the Experian 38 sectors we use official survey data:

- In the case of employee jobs, we use the Annual Business Inquiry (ABI) and Business Register & Employment Survey (BRES). These are annual surveys which are not updated after being published – further the methodology has changed over the lifetime of these surveys. We apply a principled set of rules to derive consistent employee job shares within the Sections from the surveys.
- The March 2020 RPS saw the inclusion of the 2019 BRES, which provides data up to 2018. Pre-2010 we have made a working-owners adjustment, based on an overlapping year published by NOMIS in February 2013, in line with their recommended techniques for dealing with discontinuities.
- In the case of self-employed jobs, we use data from the Labour Force Survey (LFS).

Workforce jobs is the sum of employee jobs, self-employed jobs, government trainees and Her Majesty's Forces (who are assigned at the sector level to Public Administration and Defence).

To estimate full-time equivalent employment (FTE), we use data on hours worked in each sector and region derived from the Annual Survey of Hours and Earnings (ASHE). ASHE is also used to derive wage data for each region and sector.² We also use, for this purpose, compensation of employee data from the regional accounts.

Previously, regional gross value added data (GVA), was only measured on an income basis and published annually in current prices. As of March 2020, we have included the ONS balanced estimate

¹ The ONS has ceased publishing official 2-digit employee jobs data for the regions. The approach we have taken is consistent with the approach recommended by the ONS to derive 2-digit estimates.

² We do not routinely publish sector level wage forecasts; however, it is available on request.

of GVA, a new measure derived by balancing the income and production approaches to calculating GVA. The data is published in greater detail than the previous income-based estimates - which were only published at a section level - and so map more directly to Experian's 38 sectors.

Estimates of Chain Volume Measure GVA previously had to be constructed using UK industry deflators, however, official CVM estimates are now produced at a regional level. The data is produced at the same level of disaggregation as the current price data and is made quarterly using workforce jobs data, before being aggregated to produce a regional total.

While these fundamental changes to the underlying data have led to noticeable historical revisions across the 38 sectors, the inclusion of more detailed official data provides a more accurate measure of regional GVA across industries.

Income is published in the regional accounts on an annual basis with a full breakdown of income sources and deductions. Previously official sources included income from Non-Profit Institutions Serving Households (NPISH) in the household income data due to lack of credible information to split these. But more recently, the ONS has improved their data accuracy by providing income data that is 'households' only, which we have used, thereby excluding NPISH from our income estimates, in the March 2019 vintage.

Income sources are:

- compensation of employees: wages and salaries *plus* employers' social contributions
- self-employment income
- Net Property Income: made up of property income received *less* income paid
- transfers from the State (i.e. benefits and pensions)
- other Transfers

Income deductions are:

- taxes
- social contributions
- transfers to others

The sum of income sources *less* income deductions constitutes disposable income. To convert this annual data to quarterly jobs we use (depending on the component) employee jobs, self-employee jobs or the UK quarterly pattern. We constrain these quarterly series to the official UK published data. Real disposable income is obtained by deflating disposable income by the consumer price deflator.

Household spending is derived by sharing out UK nominal expenditure using regional shares of expenditure reported in the Living Costs and Food Survey by type of expenditure. Nominal regional spending is deflated by published UK deflators and then aggregated to produce a regional total. This again implicitly creates a regional cost of living measure which we also publish.

Sub-national population projections are obtained from the ONS, based on the 2016 sub-national projections for England and Scotland while Wales remains 2014-based. These are spliced onto the 2016 mid-year estimates and constrained to the latest national 2016-based projections.

Our working-age definition incorporates all announced future changes in the state pension age:

- The state pension age for women is rising from 60 to 65, equal with males. Both will then rise, in step, to 67 in our current forecast period.
- Female state retirement age began to increase from 60 in April 2012, reaching 65 by 2018q4.

- From April 2019, both men and women will see their state retirement age rise from 65 to 66, with men reaching 66 by April 2020, and women a few months later in October 2020.
- The move from 66 to 67 is scheduled from April 2026 until April 2028 for both men and women.

The 2013 Autumn Statement stated that the rise in state pension age to 68 would be moved forward from 2046 to the mid-2030's. However, with no firm date, we have not yet incorporated this into our working age and state retirement age definitions.

Under the current law, the State Pension age is due to increase to 68 between 2044 and 2046. Following a recent review, however, the government announced plans to bring this timetable forward. The State Pension age is now set to increase to 68 between 2037 and 2039. The policy change was announced as of July 2017

We publish the following breakdown of population: school age (ages 0-15), state working age, state retirement age, adult population (16 and over) and total. Beginning in the March 2015 RPS, we also publish both the population aged 16-64 and 65 and over. Although their respective participation rates are not published, they can be derived. Our overall participation rate is based on a ratio of the total labour force to the entire adult population (not only the working age population).

3.2.2 Forecast

The regional model is sequential. Each variable is dependent only on variables earlier in the sequence and not variables later in the sequence. Variables are either workplace-based (red outlined boxes) or residence-based (green-outlined boxes.) Workplace-based and residence-based variables are linked by commuting relationships derived from the 2011 Census.

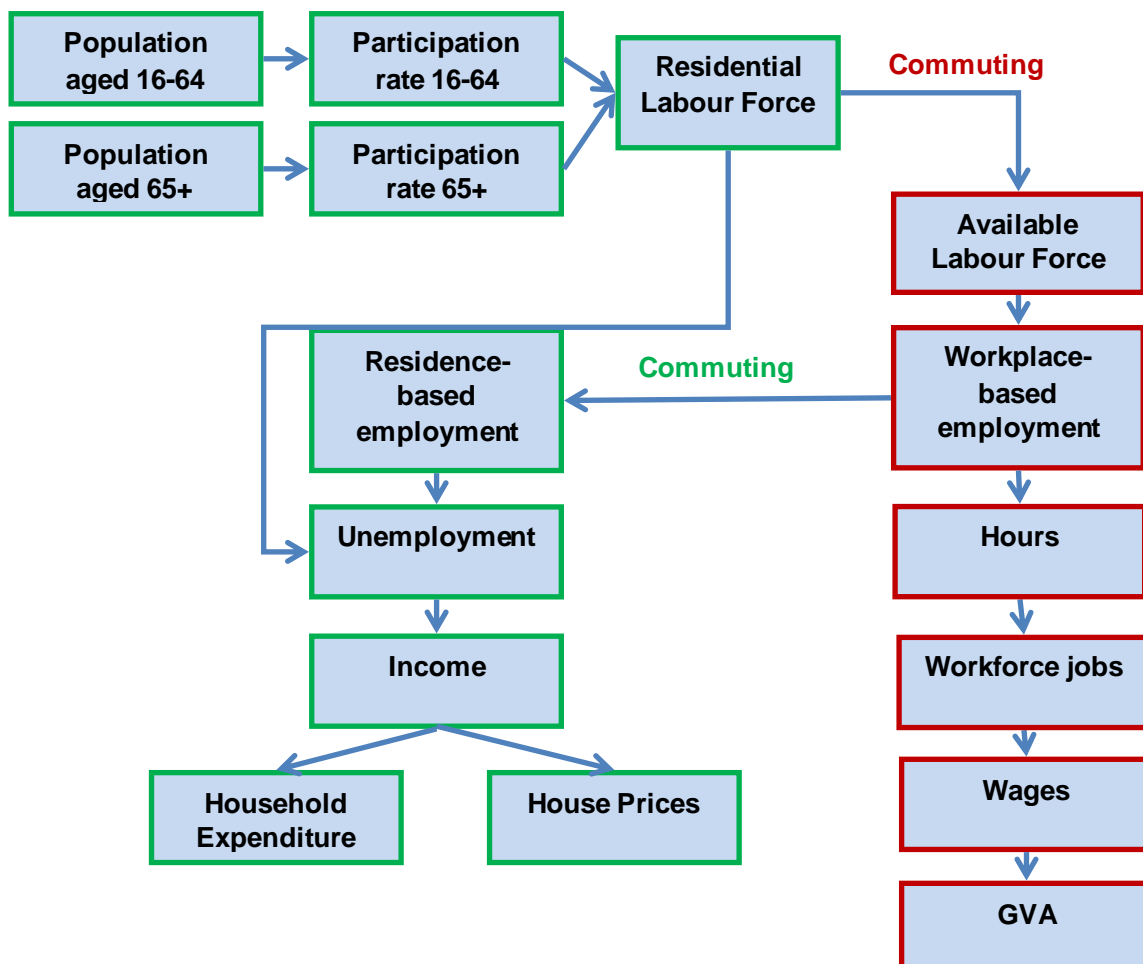

The population – split into two age ranges – is taken from the National and Sub-National Population Projections. We forecast participation rates for these age bands separately as they are subject to different trends. The total residential labour force is the sum of the labour force aged 16-64 and 65-plus. The aggregate participation rate is determined by two factors:

- The participation rate of the two age bands; and
- The share of each of the two age bands in the adult population.

The participation rate for those aged 16-64 is expected to remain relatively stable throughout the forecasting period. However, the rate for those aged 65 and over will grow strongly due to factors such as increasing life expectancy and rising state pension ages.

At the UK level, the share of the adult population aged 65 and over is projected to rise sharply over the next twenty years. There is, however, considerable variation at the regional level. Greater London – the youngest region in the UK – is projected to have a stable share.

These factors combine to produce substantial variation in the labour force forecasts for different regions.

Commuting flows are used to derive the available labour force for a region. This is:

Workers Resident in the Region – Workers Commuting Out + Workers Commuting In

In the case of Greater London, the South East and the East of England, these flows lead to a substantial difference between the residential labour force and the available labour force. The effect is still present but less pronounced in other regions.

The available labour force is one of the drivers in forecasting workplace-based employment. The other drivers include the industry mix and the performance of industries at the UK level. If industries with a high share in the region are performing well at the UK level, this will benefit the region.

The workplace-based employment is converted back into residence-based employment. This is:

Workplace-based Employment – Workers Living Elsewhere + Residents Working Elsewhere

From this point, residence and workplace-based variables are solved in parallel with residence-based variables dependent on residence-based employment and workplace-based variables dependent on workplace-based employment.

The residential labour force and residence-based employment are used to calculate unemployment. Residential income is driven by employment; and itself drives house price and household expenditure forecasts.

Workplace-based employment drives aggregate hours worked, wages and GVA. These aggregate variables feed into the detailed part of the model, which produces forecasts for each industry:



In each case, we forecast shares of the region within the UK industry. We then share out the UK industry data subject to the constraint of the total that has already been determined and the UK total.

3.3 Local methodology

3.3.1 History

As at the regional level, all local economic history used in the RPS is derived from official statistics published by the ONS. Our approach to using this data is identical to that given above at 3.2.1. However, data at the local level is more likely to be incomplete¹ or inconsistent² than is the case at the regional level. For this reason, there is greater call for the application of techniques to construct missing data and to remove inconsistencies than is the case at the regional level.

In all cases, local area data in a particular region is constrained to match the regional total for the same variable. This has two particular advantages:

- Local data is made consistent with regional data of the same vintage.
- Where local data has been estimated or constructed, the regional data ensure that the estimates together are consistent with more reliable data.

The ONS do not publish a workforce jobs series at the local level. Accordingly, we construct workforce jobs series for each local area using BRES/ABI in the same way that BRES is used at the regional level to disaggregate section estimates. The BRES share for a particular industry of a local area in its parent region is used to disaggregate the regional workforce jobs series for that industry. As BRES is a survey, the figures over time for a particular local area industry combination can be volatile³. Further, certain years' results may be withheld to prevent disclosure of confidential data. Accordingly, to obtain sensible data it is necessary for us to smooth out this volatility and to interpolate over the gaps.

At the local level, the most timely and comprehensive data are Annual Population Survey (APS) for residence and workplace-based employment and unemployment data⁴. These data are obtained directly from NOMIS and then constrained to the national numbers.

In September 2015, we re-visited the relationship between local workforce jobs and workplace-based employment. The local workforce jobs (which make use of BRES shares) was benchmarked to the ILO workplace-based employment which itself has first been benchmarked to the Census 2011 point with the pattern in years either side preserved.

As with regional gross value added, the availability of data at the local authority level has been improved with the move to a balanced estimate of GVA. Sub-regional measures of GVA were previously only produced in current prices, at a NUTS2 and NUTS3 level. As of March 2020, the balanced estimate of GVA has been incorporated into the RPS which is now provided at a local authority level, in both current and constant prices.

The level of industrial detail of the data varies across sub-regional geographical levels. NUTS2 data has the greatest level of industry disaggregation with a full breakdown of SIC sections. With each subsequent geographic level, the degree of disaggregation in the official data decreases. In order to provide local area forecasts at the 38-sector level, the data had to be fully disaggregated at each geographical level.

¹ For some local areas, publication of certain data by the ONS is restricted because to do so would effectively disclose individual responses to ONS data-collection surveys (e.g. if there are only one or two firms in a certain industry in a particular locality.)

² In some cases, sample sizes in ONS data-collection surveys at the local level are very small. This leads to data of comparatively poor quality and relatively high volatility.

³ The volatility represents sampling variability rather than actual volatility in the population data.

⁴ In line with ONS guidelines, we use the official model-based estimates of local unemployment that are more accurate than survey data which suffers from volatility.

In the case of NUTS3 current prices, the data is disaggregated using the industry shares in the corresponding NUTS2 and then constrained to that parent region. For local authorities that do not constitute fully a NUTS3, disaggregation takes place using local authority workforce jobs data at the industry level. These estimates are then made quarterly using workforce jobs data and aggregated to produce a nominal local authority total.

In the case of Chain Volume Measure GVA; where data is needed to be further disaggregated, implied deflators of the parent geography - NUTS2 in the case of a NUTS3 and NUTS3 in the case of a local authority - are used to deflate the nominal estimates. Due to excessive volatility in the raw GVA data, it is necessary to smooth the local authority estimates and constrain to the parent region. In some cases, this led to some magnitude of difference from the published ONS figures.

The inclusion of these new official statistics has led to noticeable historical revisions across the 38 sector forecasts, however, as is the case at the regional level, the data now provides a more accurate measure of historical activity in each local authority.

In the case of Income (which is households only¹), official data is also now produced at a local authority level. This data has been incorporated in the RPS as of March 2020 and, as is the case with regional level data, a full breakdown of income is provided. Prior to this, the lowest level of geography for which the data was available was NUTS3 and this supersedes the need to disaggregate the NUTS3 data to a local level.

No estimates of household spending are provided at the local level. Household spending is, therefore, derived by using the share of local disposable income in regional disposable income.

Since June 2016, we have applied a moving average procedure to smooth the Annual Population Survey data which has resulted in revisions to our historical data.

We have not used any local data published after January 2020 in producing this update of the RPS. It is possible that between this date and the release of the RPS some new history may have been released and/or revised.

3.3.2 Forecast

The local authority model is run separately for the local authorities in each region and takes the regional forecast as given. Accordingly, as with local history, local forecasts are constrained to the regional forecasts of the parent region.

Our local model is based on the resolution of demand and supply for labour and it takes into account commuting between local areas within a region and across the regional boundary. The properties of the model are these:

- When unemployment is low, labour supply growth is the key determinant of growth.
- When unemployment is high, growth in demand for labour is the key determinant of growth.
- As unemployment decreases,
 - Labour supply growth becomes relatively more important
 - Growth in demand for labour becomes relatively less important
- An area's workplace employment growth depends on labour supply not only in the area but also

¹ i.e. excludes NPISH as of the March 2019 vintage as ONS now provides more accurate income data by 'households' only at regional and local level

- Labour supply growth in other local areas in the region from which it has historically drawn inward commuters.
- Its historic share of incoming workers across the regional boundary.
- An area's residence based employment growth depends on demand for labour not only in the area but also
 - Growth in demand for labour in other local areas in the region to which it has historically supplied commuters.
 - Its historic share of outgoing workers commuting across the regional boundary.
- Workplace based employment drives GVA growth.
- Residence based employment drives Income and, accordingly, spending growth.

The starting point is an estimate of the growth in the participation rate of those aged 16-64 and 65-plus in a local area. These are used to derive labour force growth.

In parallel, demand for labour is estimated. This is done at the industry level by linking job growth¹ in a local area to growth in the same industry at the regional level and then constraining demand for jobs by industry to demand for jobs for the same industry at the regional level. The effect of this is:

- Demand for jobs at the local level is fastest in those industries which are performing best at the regional level.
- Total demand for jobs at the local level depends on its industrial structure. Those local areas which have a more than proportionate share of the best performing industries will perform best overall.

The supply and demand for labour is then resolved in the following way:

- Total demand² for jobs for each local area is converted into demand for workers according to the historic ratio between jobs and workers into that local area.
- The inflow and outflow of workers across the regional boundary is shared out between local areas according to their historic commuting patterns leading to an adjustment in
 - The remaining demand for labour for a local area (*inflow*)
 - The remaining available labour for a local area (*outflow*)
- Workplace demands for workers are converted into residence-based demands according to historic commuting patterns.
 - If unemployment is sufficiently high, these demands are satisfied out of the growth in the labour supply and the pool of available (unemployed) workers.
 - If unemployment is sufficiently low, these demands can only be satisfied out of the growth in the labour supply.
 - If unemployment is above its lower bound but not too high, a proportion of demands are satisfied out of the pool of available workers and the rest are satisfied out of the growth in the labour supply.
 - The model makes short-term adjustments in the labour supply in response to demand conditions to reflect the economic reality that
 - When demand is high, the participation rate rises as potential workers are drawn into the labour force by the relatively buoyant conditions;
 - When demand is low, the participation rate declines as disillusioned workers leave the labour force because of the poor job market conditions;
 - The unemployment rate, accordingly, behaves as expected.

¹ Separately for employee jobs, self-employee jobs, government trainee jobs and Her Majesty's Forces.

² i.e. all industries and job types aggregated.

- The satisfied residence supply for labour is converted back into workplace demands and workplace-based employment is calculated for each local area. This is then converted back into jobs and used to produce final workforce jobs estimates for each local area.

The consequence of this is that:

- Local areas with high demand may not see all of that demand satisfied if there is insufficient available labour supply to meet those needs. Jobs growth will, accordingly, be slower.
- Local areas with high labour supply may not see higher growth in residence employment if there is insufficient demand for labour to use it up.

GVA growth is then forecast based on growth in workplace-based employment according to equations, which link GVA growth to workplace-based employment. Income is forecast by component based on residence-based employment (in the case of compensation for employees or self-employment), unemployment (in the case of benefits) and population in any other case. Spending depends on income by component.

4 Key changes since June 2020 RPS

4.1 UK forecast

The September RPS forecast is consistent with the August 2020 UK macro forecast. **These projections reflect the ‘Delayed-V-shape’ scenario, which is our base case. Given the uncertainty surrounding the pandemic and its impact on the economy we have produced a number of scenarios which help illustrate the different channels of impact. For details on the other scenarios please contact us.**

The latest national accounts data confirm that, since lockdown began in March, the economy has suffered an unprecedented contraction, with a record fall of 20.4% on the quarter, in 2020Q2. Early experimental estimates suggest the unemployment rate to have risen close to 5% at the end of July. Over 9 million employees have been furloughed, with close to 3 million of those self-employed receiving income support. The gradual reopening of businesses as well as government measures to stimulate the hospitality sector has seen growth return in the summer months, though new government measures aimed at suppressing the virus (curfews, increased fines) could see growth become muted.

There are signs that pent up demand triggered a surge in consumer spending as shops reopened, with Eat Out to Help Out seeing 60 million meals claimed for, and retail sales surging 16.7% in the three months to August. However, pent up demand is expected to wane, and the hit to consumer incomes as the furlough scheme unwinds will place a constraint on spending as affordability concerns come to the fore. The sustainability of the recovery will depend on the successful implementation of a track and trace scheme, which will be key for both keeping Covid-19 cases controlled and rebuilding confidence, a necessary prerequisite for consumers to return to the high street.

For now, our view is that any emerging recovery will be gradual in the near term but this could quickly unwind with more restrictions in the winter months. The pace of growth will also be curbed by ongoing supply side constraints as businesses implement social distancing measures and operate under restricted trading hours. On the demand side, consumers will remain cautious about venturing out against a backdrop of rising cases, particularly until a reliable track and trace scheme, which has been beset with challenges, is properly established. The squeeze on incomes from the rise in unemployment and furloughing will also dampen confidence and willingness to spend.

September 2020 RPS forecast. Previous forecast (May 2020 macro = June 2020 RPS) in brackets.

UK	2017	2018	2019	2020	2021-2027	2028-2040
GDP growth	1.9% (1.9%)	1.3% (1.3%)	1.5% (1.4%)	-11.7% (-15.4%)	3.2% (3.9%)	1.7% (1.7%)
Workforce Jobs growth	1.0% (1%)	0.6% (0.6%)	1.7% (1.7%)	-2.4% (-3.7%)	0.9% (1.1%)	0.5% (0.5%)
Unemployment rate	4.4% (4.4%)	4.1% (4.1%)	3.8% (3.8%)	6.9% (8.3%)	5.3% (5.3%)	4.0% (4.1%)
Real Income growth	1.4% (1.4%)	2.5% (2.5%)	1.3% (1.3%)	-3.2% (-5.3%)	1.9% (2.7%)	1.9% (1.9%)
Spending Volumes growth	2.2% (2.2%)	1.6% (1.6%)	1.0% (1.1%)	-13.0% (-16.3%)	3.1% (4%)	1.8% (1.8%)
House price growth	4.5% (4.5%)	3.2% (3.2%)	1.2% (1.2%)	-2.6% (-3.4%)	3.8% (4%)	4.0% (4%)

UK Outlook

The following was the outlook in August, consistent with the regional forecast.

Our UK macro view is updated monthly and can be found on our website:

<https://analyticsondemand.experian.co.uk/discover/economics/uk-economic-forecasts/>

The latest data released by the ONS shows that GDP grew by 6.6% in July as coronavirus-related restrictions continued to ease. This follows gains of 1.8% and 8.7% in May and June respectively, but the economy remains 11.7% smaller than it was in February, before the Covid-19 pandemic struck.

Services, manufacturing, construction and agriculture all grew, by 6.1%, 5.2%, 17.6% and 1.1% respectively. Despite the gains, none of the main sectors of the economy are as large as they were in February, and growth slowed relative to June.

With the reopening of a wider number of sectors of the economy in July, including the food and accommodation sectors, it is unsurprising that output rose for a third consecutive month. Further gains are likely to show in the August and September data, supported by a boost to restaurant activity from the government's Eat Out to Help Out scheme, and the reopening of schools.

However, as we move into Autumn these easy economic wins are going to be more difficult to come by. With the number of Covid-19 cases on the rise, public health restrictions are more likely to intensify than relax in the short-term. In addition, unemployment is expected to rise markedly as the furlough scheme comes to an end in October, constraining any recovery in household incomes and spending.

Key risks

Lockdown measures have been easing in recent months. Since August 1st many leisure settings have reopened. Social distancing has been eased, and where it is not possible to maintain two metres, one metre plus is to be kept instead. However, new restrictions introduced could see suppression measures intensify. Whilst considerably looser than the measures introduced in March, it is yet unclear how much this will drag on growth. UK output could rebound more durably if measures follow a risk-mitigation strategy surrounding Covid-19, and more quickly than in our base case if consumer confidence responds positively, facilitating a greater than projected rise in household spending.

The easing in restrictions has raised the risk of a resurgence in the virus, with local flare-ups leading to a localised form of lockdown. This has delayed the government's plans to ease restriction measures further and led to new rules on gatherings and business trading hours. If such flare-ups manifest nationwide, as government support to businesses and households unwinds, there is a real risk of a renewed recession. This could see the unemployment rate and business insolvencies spike even higher and potentially lead to greater long-term scarring to the economy.

The end of the Brexit transition period at the end of 2020 is fast approaching, and a trade deal between the UK and EU is yet to be agreed. The terms of the final deal will play a significant part in shaping the UK's economic fortunes in the long-term. The impact on external trade, foreign direct investment and migration flows are of particular importance as these influence the UK's long-term economic growth potential via labour supply and productivity. There will be a trade-off between market access and control over EU migration, so there is a real risk that the UK will have to accept significantly less favourable terms of access, which could undermine prospects for trade and investment. No adjustments have been made to the underlying population projections in our base case, but downside risks clearly exist on this front from a potential slowdown in EU migration. There is also now a significant possibility that there will be a no-deal Brexit.

4.2 Regional Forecast

This RPS round reflects only changes to the UK history to which our regional data is constrained.

September 2020 RPS forecast. Previous forecast (June 2020 RPS) in brackets.

Regional forecast	SW	SE	GL	ET	EM	WM	NW	NE	YH	SC	WA	NI
2019-40 ave. growth												
GVA growth	1.4% (1.4%)	1.8% (1.8%)	2.1% (2.1%)	1.7% (1.7%)	1.3% (1.4%)	1.3% (1.4%)	1.2% (1.4%)	1.0% (1.1%)	1.1% (1.4%)	1.1% (1.2%)	1.0% (1.3%)	0.9% (1.1%)
Workforce Jobs growth	0.5% (0.6%)	0.8% (0.7%)	0.8% (0.8%)	0.7% (0.6%)	0.5% (0.6%)	0.5% (0.5%)	0.4% (0.5%)	0.1% (0.1%)	0.4% (0.4%)	0.3% (0.3%)	0.3% (0.4%)	0.4% (0.4%)
Unemployment rate	4.0% (4.2%)	3.6% (4%)	5.4% (5.5%)	3.7% (4%)	4.7% (4.8%)	5.1% (5.3%)	5.2% (4.7%)	5.7% (5.8%)	4.9% (5%)	4.4% (4.3%)	4.5% (4.6%)	4.1% (4.2%)
Real income growth	1.6% (1.8%)	2.0% (2%)	1.8% (1.9%)	1.9% (1.9%)	1.5% (1.6%)	1.4% (1.5%)	1.5% (1.6%)	1.2% (1.3%)	1.5% (1.6%)	1.3% (1.4%)	1.3% (1.4%)	1.4% (1.5%)
Spending volumes growth	1.3% (1.5%)	1.8% (1.9%)	2.2% (2.3%)	1.6% (1.7%)	1.3% (1.5%)	1.2% (1.4%)	1.3% (1.5%)	1.0% (1.2%)	1.2% (1.4%)	1.1% (1.3%)	1.0% (1.2%)	1.2% (1.4%)
House price growth	3.4% (3.4%)	3.9% (3.9%)	3.8% (3.8%)	3.5% (3.5%)	3.2% (3.2%)	3.4% (3.4%)	3.5% (3.5%)	2.9% (2.9%)	2.7% (2.7%)	3.2% (3.2%)	3.2% (3.2%)	3.2% (3.2%)

4.3 Local Forecast

Changes to the local history are due to revisions at the UK level to which our local data is ultimately constrained.

For more information about how the history is constructed refer to [section 3.2.1](#) for regions and [section 3.3.1](#) for local authorities.

4.4 Population

There have been historical revisions for areas within England and Wales for mid-2012 to mid-2016 due to “improved methods for international emigration at the local authority, previously unavailable data for international immigration at the local authority level and improvements to accounting of the dependents of foreign armed forces personnel”.

We continue to include the 2016-based sub-national population projections for England and Scotland and as of the March 2019 RPS, we have accounted for revisions to the population projections. The key points highlighted in the release are:

- The populations of all regions in England are projected to grow by mid-2026; regions in the north of England are projected to grow at a slower rate than those in the south.
- London is projected to be the fastest growing region; the North East is projected to have the slowest rate of growth.
- Nearly all local authorities are projected to grow by mid-2026; the populations of just 15 local authorities are projected to fall.

- Tower Hamlets is projected to be the fastest growing local authority in England; its population is projected to grow by 17.8% between mid-2016 and mid-2026.
- The number of people in older age groups is projected to grow faster than those in younger age groups in all but five local authorities; by mid-2026, a total of 97 local authorities are projected to have a population where at least one-quarter of the population is aged 65 and over.
- Over the 10 years to mid-2026, London is the region with the fastest increase in population of those aged 65 and over; however, it remains the region with the lowest old age dependency ratio.

5 A note from the ONS on volatility

A change in methodology behind Office for National Statistics (ONS) employment surveys has produced widespread volatility in the historical data, particularly from 2010.

The following is an explanation directly from the ONS, please see [section 3](#) for more information on how we deal with volatility in the official data:

“A fundamental redevelopment of Workforce Jobs sources, classifications, methods and systems was recently undertaken and is explained clearly in the article ‘Revisions to Workforce Jobs’ (Barford 2010). One of the key changes highlighted in this article was the replacement of a matched-pairs estimator with a point-in-time ratio estimator, ONS’s standard method. This change was aimed at removing the bias caused by the matched-pairs method. A matched-pairs method tends to underestimate change over time, as it excludes the births and deaths of businesses in the sample. In essence, only those businesses sampled in two consecutive periods are used to produce estimates of change. This bias used to cause large revisions when the short-term employment surveys series were benchmarked retrospectively to Business Register Employment Survey (BRES) estimates. BRES is an annual survey which selects a larger sample and also uses a point-in-time ratio estimator. The point-in-time estimator includes all sampled businesses in each and every period, which reduces the bias over-time. The trade-off is an increase in volatility caused by the inclusion of the rotated part of the sample for small and medium sized businesses. Sample rotation spreads the administrative burden; ensuring businesses are selected for a limited number of periods.

Unfortunately, the volatility of regional estimates at an industry level has been far greater than anyone anticipated and in general has been met unfavourably by users, particularly those that are interested in regional data. There are a number of instances, for example, whereby businesses have been ‘rotated in’ to a particular region and served to distort the level of jobs for a particular industry, usually for a period of 5 quarters, which is the time a rotated business remains in the sample of the STES.”

Regional employment is the most timely and only source of quarterly data at this level of geography and is used to derive the quarterly profile of other variables in our regional models. Therefore, this volatility is reflected in output as well as employment. Please see [section 3](#) for more information on how we deal with volatility in the official data.

Appendix A....Glossary of terms

Glossary of terms

Gross Domestic Product (GDP) Total work done in an economy in a period measured in one of three ways:

- Output Measure: Output of all goods and services less inputs
- Income Measure: Income earned by all parts of the economy
- Demand Measure: Demand for goods and services comprised of
 - Expenditure by Households, NPISH and Government
 - Investment (Gross Fixed Capital Formation) by business and Government
 - Changes in Inventories and Acquisitions less disposals of valuables
 - Exports less imports

GDP is measured in market prices: this means that the prices used to convert output of goods and services into money include taxes and subsidies by the government. Distributors' margins are credited to the industry producing the goods and services not to the distribution industry.

Gross Value Added (GVA) GVA is identical to GDP except that it is measured in basic prices. These prices do not include taxes and subsidies imposed by the government. Distributors' margins are credited to the distribution industry. GVA for an industry is described by either of the following identities:

- GVA is identical to output of the industry less inputs of the industry
- GVA is identical to the sum of
 - Compensation of Employees in the industry
 - Gross Operating Surplus (i.e. profit) earned by capital in the industry

When looking at GVA for an industry, it is important to realise that it only includes the output of that industry (i.e. the value added by that industry.) For example retailing GVA only includes the value added by retailers (e.g. customer service etc).

GVA in the RPS is measured by the place where the work is done (workplace based) and not where the worker resides.

Current Price / Chain Volume Measure (CVM) Data where the unit of measurement is money are available either in Current Price (or Nominal) terms or CVM (or Real) terms. The distinction is important because the buying power of money changes over time. For current price data, no adjustment is made for this fact. CVM data adjusts all figures in a time series to be consistent with the buying power of money in a given year (the reference year). Current Price data, thus, measures values while CVM data measures volumes. For example, Current Price GDP is the money value of production in a given period while CVM GDP is the amount of production. For years before the reference year, CVM data is not additive (thus the sum of GVA for all sectors will not equal total GVA.) In all other years, CVM data is additive.

Productivity A measure of efficiency calculated by estimating output per unit of input

Workforce Jobs A count of the total number of jobs in the UK, a region or industry. It is comprised of

- Employee Jobs: The number of jobs where the occupant is an employee.
- Self-employee Jobs: The number of jobs where the occupant is self-employed
- Government-Sponsored Trainees: The number of jobs where the occupant is on a government training scheme.
- Her Majesty's Forces: The number of jobs in the armed forces (part of Public Administration & Defence).

Workforce jobs and all its components count jobs and not people. This means that where a person has two or more jobs they are counted once for each job that they have. This can be contrasted with the ILO employment measures. Another consequence of counting jobs is that Workforce Jobs is based on the place of work not the residence of the worker

Full Time Equivalent Employment: Our definition is based on total hours worked and is as follows:

FTE = (HOURS) divided by (37.8*13)

Here a constant yard-stick of full-time employment for all industries, regions and industry-region based on thirteen working weeks in a quarter at 37.8 hours a week. 37.8 hours is the average hours worked by a full-time worker in the UK between 1990 and 2009.

ILO Employment The International Labour Organisation (ILO) provides an international standard method of measuring employment. In the UK this is implemented by means of a survey known as the Labour Force Survey (LFS) or Annual Population Survey (APS). It is a people count based on the main job that a person has. Employment comprises:

- Employees: People whose main job is as an employee.
- Self-employed: People whose main job is as a self-employed person.
- Government-Sponsored Trainees: People whose main job is on a government training scheme.
- Unpaid Family Workers: People whose main job is as an unpaid worker in a business owned by their own family.

There are two measures:

- Residence based, which depends on the place of residence of the worker (irrespective of where they work.)
- Workplace based, which depends on the place of work of the worker (irrespective of where they reside.)

The ILO Employment reported is based on the entire population in work ages 16+.

ILO Unemployment The International Labour Organisation (ILO) definition of unemployment covers people who are: out of work, want a job, have actively sought work in the previous four weeks and are available to start work within the next fortnight; or out of work and have accepted a job that they are waiting to start in the next fortnight.

ILO unemployment is only available on a place of residence basis and is based on the entire unemployed population ages 16+.

Labour Force / Economically Active The sum of ILO Unemployment and ILO Employment. That is all people who are in work or who are looking for a work. A person who is in the labour force is said to be Economically Active.

The Labour Force includes the entire Economically Active population ages 16+.

Economically Inactive A person who is not economically active. The principle categories are retirees, students, children, long-term sick or disabled, homemakers and carers. This does not include school-aged people.

Claimant Count Unemployment Measures the number of people who are claiming Jobseekers' Allowance (JSA). This is always less than ILO Unemployment because not everyone who is ILO unemployed is eligible to claim JSA and not all who are eligible claim. Particular important cases are:

- People whose partners work more than 16 hours a week – they cannot claim JSA but may be ILO unemployed.
- People who are past state retirement age – they cannot claim JSA but may be ILO unemployed.

Extra Region In addition to the 9 English regions and the nations of Scotland, Wales and Northern Ireland, the UK's economic boundary includes the continental shelf and UK government operations abroad (i.e. embassies and HMF abroad). The ONS does not assign income or GVA attributable to these sources to any region or nation. Therefore, the sum of regional Income or GVA does not equal the UK. This also impacts on two industries Extraction & Mining and Public Administration & Defence.

School Age Population Population aged 0-15.

Working Age Population Population above the age of 15 but below the current state retirement age for their gender.

Retirement Age Population The population above state retirement age. The precise retirement date depends on date of birth and, for those born before 6th November 1953, on gender. At present, there is a phased equalisation in progress. After 6th November 2018, both men and women will retire at 65. This will rise to 66 between 6th March 2019 and 6th September 2020 and 67 between 6th April 2026 and 6th March 2027. Our forecasts take account of these changes to retirement legislation.

Adult (16+) Population Number of all people aged 16 and above.

Household Consumer Spending The accounts relate to consumption expenditure by UK resident households, either in the UK or the rest of the world. Spending by non-residents in the UK is excluded from the total

Household consumption includes goods and services received by households as income in kind, in lieu of cash, imputed rent for the provision of owner-occupied housing services and consumption of own production

For national accounting purposes, households are individuals or groups of people sharing living accommodation

Household Disposable Income Household disposable income is the total payment to households (from wages, interest, property income and dividends) less taxes, social security, council payments and interest

Cost of living index Regional consumer spending deflator. Gives an indication of how the value of consumer spending has grown in comparison to the volume.

NUTS (Nomenclature des Unités Territoriales Statistiques – Nomenclature of Territorial Units for Statistics) A European Union standard for classifying the subdivisions of member states. In the case of the UK, the English regions and the three nations are classified as NUTS1. The next level – NUTS2 – typically consists of aggregations of local authorities in the same region. The level below that, NUTS3 consists either of single local authorities or a small aggregation of local authorities in the same NUTS2. In Scotland, some local authorities are divided between NUTS3. NUTS4 and NUTS5 also exist but are not used in the RPS.

Appendix B...Sector definitions

Sector definitions

Experian 38-sector	SIC-2007 division	Falls within Experian 12-sector
Agriculture, Forestry & Fishing	01 Crop and animal production, hunting and related service activities	Agriculture, Forestry & Fishing
	02 Forestry and logging	
	03 Fishing and aquaculture	
Extraction & Mining	06 Extraction of crude petroleum and natural gas	Extraction & Mining
	05 Mining of coal and lignite	
	07 Mining of metal ores	
	08 Other mining and quarrying	
	09 Mining support service activities	
Food, Drink & Tobacco	10 Manufacture of food products	Manufacturing
	11 Manufacture of beverages	
	12 Manufacture of tobacco products	
Textiles & Clothing	13 Manufacture of textiles	
	14 Manufacture of wearing apparel	
	15 Manufacture of leather and related products	
Wood & Paper	16 Manufacture of wood and of products of wood and cork, except furniture; manufacture of articles of straw and plaiting materials	
	17 Manufacture of paper and paper products	
Printing and Reproduction of Recorded Media	18 Printing and reproduction of recorded media	
Fuel Refining	19 Manufacture of coke and refined petroleum products	
Chemicals	20 Manufacture of chemicals and chemical products	
Pharmaceuticals	21 Manufacture of basic pharmaceutical products and pharmaceutical preparations	
Rubber, Plastic and Other Non-Metallic Mineral Products	22 Manufacture of rubber and plastic products	
	23 Manufacture of other non-metallic mineral products	
Metal Products	24 Manufacture of basic metals	
	25 Manufacture of fabricated metal products, except machinery and equipment	
Computer & Electronic Products	26 Manufacture of computer, electronic and optical products	

	27 Manufacture of electrical equipment	
Machinery & Equipment	28 Manufacture of machinery and equipment n.e.c.	
Machinery & Equipment	29 Manufacture of motor vehicles, trailers and semi-trailers	
	30 Manufacture of other transport equipment	
Other Manufacturing	31 Manufacture of furniture	
	32 Other manufacturing	
	33 Repair and installation of machinery and equipment	
Utilities	35 Electricity, gas, steam and air conditioning supply	Utilities
	36 Water collection, treatment and supply	
	37 Sewerage	
	38 Waste collection, treatment and disposal activities; materials recovery	
	39 Remediation activities and other waste management services. This division includes the provision of remediation services, i.e. the cleanup of contaminated buildings and sites, soil, surface or ground water.	
Construction of Buildings	41 Construction of buildings	Construction
Civil Engineering	42 Civil engineering	
Specialised Construction Activities	43 Specialised construction activities	
Wholesale	45 Wholesale and retail trade and repair of motor vehicles and motorcycles	Wholesale & Retail
	46 Wholesale trade, except of motor vehicles and motorcycles	
Retail	47 Retail trade, except of motor vehicles and motorcycles	
Land Transport, Storage & Post	49 Land transport and transport via pipelines	Transport & Storage
	52 Warehousing and support activities for transportation	
	53 Postal and courier activities	
Air & Water Transport	50 Water transport	
	51 Air transport	
Accommodation & Food Services	55 Accommodation	Accommodation, Food Services & Recreation
	56 Food and beverage service activities	
Recreation	90 Creative, arts and entertainment activities	
	91 Libraries, archives, museums and other cultural activities	
	92 Gambling and betting activities	
	93 Sports activities and amusement and	

	recreation activities	
Media Activities	58 Publishing activities	Information & communication
	59 Motion picture, video and television programme production, sound recording and music publishing activities	
	60 Programming and broadcasting activities	
Telecoms	61 Telecommunications	
Computing & Information Services	62 Computer programming, consultancy and related activities	
	63 Information service activities	
Finance	64 Financial service activities, except insurance and pension funding	Finance & Insurance
	66 Activities auxiliary to financial services and insurance activities	
Insurance & Pensions	65 Insurance, reinsurance and pension funding, except compulsory social security	
Real Estate	68 Real estate activities	Professional & Other Private Services
Professional Services	69 Legal and accounting activities	
	70 Activities of head offices; management consultancy activities	
	71 Architectural and engineering activities; technical testing and analysis	
	72 Scientific research and development	
	73 Advertising and market research	
	74 Other professional, scientific and technical activities	
	75 Veterinary activities	
Administrative & Supportive Activities	77 Rental and leasing activities	Service
	78 Employment activities	
	79 Travel agency, tour operator and other reservation service and related activities	
	80 Security and investigation activities	
	81 Services to buildings and landscape activities	
	82 Office administrative, office support and other business support activities	
Other Private Services	94 Activities of membership organisations	
	95 Repair of computers and personal and household goods	
	96 Other personal service activities	
	97 Activities of households as employers of domestic personnel	
	98 Undifferentiated goods- and services-producing activities of private households for	

	own use
Public Administration & Defence	84 Public administration and defence; compulsory social security
	99 Activities of extraterritorial organisations and bodies
Education	85 Education
Health	86 Human health activities
Residential Care & Social Work	87 Residential care activities
	88 Social work activities without accommodation

Appendix C... Geography definitions

We forecast at the following geographic breakdowns:

- UK
- Regions (12)
- Counties (64)
- Local authorities...post-2019 boundaries (338+33 London boroughs)

Appendix D...FAQ's

- Why does Experian's history for variable x differ from another source / raw survey data?
 - There are several possible reasons.
 - The first is a vintage mismatch. The ONS frequently revises its economic data in order to take account of new information or improved methodology. The date at which Experian has taken data for the current RPS is given in the body of this guide. Another source may have used earlier or later data.
 - The second relates to data processing. As explained in the body of this guide, it is sometimes necessary at the regional level and (particularly) at the local level to process or construct data. Our approach to doing this is explained in the body of this guide. We apply consistent methodologies to process the data. Other sources may carry this out in different ways. When compared against the raw source, our data may differ because, for example:
 - It has been constrained to other sources.
 - It has been converted into CVM data or quarterly data.
 - It has been made consistent with other data or a later vintage of data.
 - The third relates to raw survey data. Raw survey data is often volatile and does not take into account information outside the survey. Official statistics and our data are constructed from the raw survey data to take into account volatility, sampling issues and all available data sources.
- Why does Experian's job history differ from the *ABI* or *BRES*?
 - The *ABI/BRES* are surveys taken from a particular year; they are not updated.
 - *ABI/BRES* is a source for ONS' workforce jobs but it is not the only source.
 - *BRES* does not include government supported trainees, HM forces jobs and every self-employed small business. As a result, *BRES*'s employment numbers (mainly consisting of total employees and working owners e.g sole traders) would be lower than the ONS's workforce jobs.
 - Experian's workforce job history is designed to be consistent with the latest available ONS workforce jobs estimates, which includes a broad range of jobs (i.e. employee jobs, self-employment jobs, government supported trainees and HM forces).
 - Raw survey is often incomplete and suffers from sampling variability, which does not represent true volatility in the underlying population data. This must be removed to ensure high quality data.
- How often are data updated?
 - We always use the latest available data at the cut-off date for history.
 - New GVA data is available from the ONS
 - At the UK Level, three times a quarter.
 - At the Regional and Local level, annually (normally in December.)
 - New Expenditure data is available from the ONS at the UK level twice a quarter.
 - New LFS Employment data is available from the ONS once a quarter.
 - New Workforce Jobs data is available from the ONS once a quarter.
 - New *BRES* is published once a year (normally in December.)
 - New Income data is available from the ONS
 - At the UK level, once a quarter.
 - At the Regional and Local level, once a year (normally in April.)
 - Population projections are published once every two years.
 - New mid-year population estimates are published annually.
 - New LCFS is published annually.
- How do revisions to historical data affect your history and forecasts?
 - As explained above, we always take into account the latest historical data.
 - The monthly UK macro forecast is updated after each ONS revision of GDP for a quarter.
 - The RPS is based on a particular UK macro forecast and includes the latest available regional and local data.

- Forecasts are updated to be consistent with the latest historical data. While this will typically only affect the short-to-medium term, there are times when the long-run is necessarily affected. This will usually be when there has been a substantial revision to history.
- How are past growth trends captured in the forecasts?
 - All our models are econometric models.
 - An econometric model is a model estimated on historical data.
 - The coefficients (i.e. interactions) in the model embed historical relationships between variables and historical growth rates in a variable.
 - Where we believe that the forecast relationships may differ from history, we make appropriate adjustments to the forecast. This may be the case, for example, where an area has been substantially redeveloped in recent years.
- How are industry/regional/local developments and policies reflected in forecasts?
 - If past developments and policies are reflected in model inputs (for example population) or in history then they will be automatically captured by the model.
 - Our forecasts are policy-neutral in the sense that in our baseline assumes that sufficient projects, infrastructure, jobs etc. will be provided in order to meet the needs of the population in the long term. Thus although the project may not be explicitly included, an assumption that a project of its nature may have been included in the baseline.
 - It is important to realise that many developments or policies may not be sufficiently large enough to affect growth rates or may be implicitly included in the forecast from a higher level of aggregation.
 - We are able to make appropriate adjustments to the forecast to take into account certain large projects.
 - At the industry level we can take into account announced developments in that industry which are large enough to affect the growth in the industry at the national, regional or local level (as the case may be).
 - At the regional and local, we taken into account announced developments or policies which are large enough to affect growth at the regional or local level. The local model, in particular, has the facility to take into account the impact of additional population or jobs in a particular area.
 - The final forecast will show the net effect of the adjustment, after the effects of population constraints, job cannibalisation, commuting patterns etc.
- How does population relate to the employment forecasts?
 - This is discussed in detail in the methodology section above for the regions and the locals.
 - It is important to remember that employment is forecast on both a residence and workplace basis.
 - Residence based employment depends on local population (labour supply) growth but also on demand for work throughout the region and across the regional boundary.
 - Workplace based employment depends on labour supply throughout the region and across the regional boundary.
- What is working age?
 - The definition of working age used based on the state pension age.
 - As the state pension age for men and women changes in line with announced policy, the working age population will change to take this into account.
 - The key changes to the state pension age that have been announced are:
 - A gradual equality in state pension age for men and women.
 - A gradual rise in state pension age for both men and women to 67 (and 68 after the forecast horizon.)
- What is the participation rate / economic activity rate?
 - The participation rate or economic activity rate is the proportion of the population who are either employed or seeking employment (i.e. unemployed.)
 - The participation rate used in our models is based on the entire adult population (16+). This differs from earlier versions of our models which used only the working age population.
 - The participation rate is an endogenous variable in all our models. It is not a fixed assumption.
- What assumptions have been made regarding commuting in the local model?
 - Commuting in the local model is based on estimates given by the ONS.

- These are based on the Census 2011.
- Commuting assumptions are fixed over the forecast.
- However, the outcome for commuting may differ from the assumption because (for example) there is insufficient demand or supply for labour to provide as many workers across a particular commuting relationship.
- How is Full-Time Equivalent employment derived?
 - This is based on the total hours worked (please see the glossary.)
 - The relationship between FTEs and hours is fixed by definition.
 - In different industries, the hours worked per job will differ.
 - Historical data for this is taken from ASHE (please see the body of the guide.)
 - The forecast takes into account changing trends in hours per job. This will necessarily alter the relationship between Full-Time Equivalent employment and jobs.
- How does the weighting of different factors change over the forecast period?
 - There is no fixed rule about the changes in this time.
 - The coefficients of the econometric equations are fixed over time
 - However, at the local level population growth becomes more important as unemployment decreases.

Appendix E...About us



Our economic forecasting expertise

Experian's team of 18 economists is a leading provider of global, national, regional and local economic forecasts and analysis to the commercial and public sectors. Our foresight helps organisations predict the future of their markets, identify new business opportunities, quantify risk and make informed decisions.

Experian's economics team is part of a 140-strong analytics division, which provides an understanding of consumers, markets and economies in the UK and around the world, past, present and future. As part of the Experian group, the analytics division has access to a wealth of research data and innovative software solutions. Its statisticians, econometricians, sociologists, geographers, market researchers and economists carry out extensive research into the underlying drivers of social, economic and market change.

For more information, visit www.experian.co.uk/economics

Experian

Experian is a global leader in providing information, analytical and marketing services to organisations and consumers to help manage the risk and reward of commercial and financial decisions.

Combining its unique information tools and deep understanding of individuals, markets and economies, Experian partners with organisations around the world to establish and strengthen customer relationships and provide their businesses with competitive advantage.

For consumers, Experian delivers critical information that enables them to make financial and purchasing decisions with greater control and confidence.

Clients include organisations from financial services, retail and catalogue, telecommunications, utilities, media, insurance, automotive, leisure, e-commerce, manufacturing, property and government sectors.

Experian Group Limited is listed on the London Stock Exchange (EXPN) and is a constituent of the FTSE 100 index. It has corporate headquarters in Dublin, Ireland, and operational headquarters in Costa Mesa, California and Nottingham, UK. Experian employs around 15,500 people in 36 countries worldwide, supporting clients in more than 65 countries. Annual sales are in excess of \$3.8 billion (£1.9 billion/€2.8 billion).

For more information, visit the Group's website on www.experiangroup.com

The word 'Experian' is a registered trademark in the EU and other countries and is owned by Experian Ltd and/or its associated companies.

Appendix 9 List of Consultees

Amber Valley Borough Council
Ashfield District Council
Bassetlaw District Council
Bolsover District Council
Boots UK
British Geological Survey
Broxtowe Borough Council
Charnwood Borough Council
Derby City Council
Erewash Borough Council
Federation of Small Businesses
FHP
Invest in Nottingham
Mansfield District Council
Muse Developments
North Kesteven District Council
Nottingham City Council
Nottinghamshire County Council
Nottingham University
Oxalis Planning
Rushcliffe Borough Council
South Kesteven District Council
West Lindsey District Council
North West Leicestershire District Council
South Derbyshire District Council
Wilson Bowden

Birmingham
0121 713 1530
birmingham@lichfields.uk

Edinburgh
0131 285 0670
edinburgh@lichfields.uk

Manchester
0161 837 6130
manchester@lichfields.uk

Bristol
0117 403 1980
bristol@lichfields.uk

Leeds
0113 397 1397
leeds@lichfields.uk

Newcastle
0191 261 5685
newcastle@lichfields.uk

Cardiff
029 2043 5880
cardiff@lichfields.uk

London
020 7837 4477
london@lichfields.uk

Thames Valley
0118 334 1920
thamesvalley@lichfields.uk